

ABB MEASUREMENT & ANALYTICS | OPERATING INSTRUCTION

ProcessMaster FEP300, FEP500 HygienicMaster FEH300, FEH500 Electromagnetic flowmeter



Measurement made easy

—
ProcessMaster
FEP300, FEP500
HygienicMaster
FEH300, FEH500

Valid as of software version

- 01/01/00 with HART
- 01/00/00 with PROFIBUS PA or FOUNDATION fieldbus

Further information

Additional documentation on ProcessMaster FEP300, FEP500/HygienicMaster FEH300, FEH500 is available for download free of charge at www.abb.com/flow.

Alternatively simply scan this code:



Manufacturer

ABB Automation Products GmbH

Measurement & Analytics

Dransfelder Str. 2

37079 Göttingen

Deutschland

Tel: 0800 1114411

Fax: 0800 1114422

Email: vertrieb.messtechnikprodukte@de.abb.com

Customer Service

Tel: +49 0180 5 222 580

Email: automation.service@de.abb.com

ABB Inc.

Measurement & Analytics

125 E. County Line Road

Warminster

PA 18974

USA

Tel: +1 215 674 6000

Fax: +1 215 674 7183

ABB Engineering (Shanghai) Ltd.

Measurement & Analytics

No. 4528, Kangxin Highway,

Pudong New District

Shanghai, 201319,

P.R. China

Tel: +86(0) 21 6105 6666

Fax: +86(0) 21 6105 6677

Email: china.instrumentation@cn.abb.com

ABB Limited

Measurement & Analytics

Oldends Lane, Stonehouse

Gloucestershire, GL10 3TA

Tel: +44 (0)1453 826 661

Fax: +44 (0)1453 829 671

Email: instrumentation@gb.abb.com

1	Safety	8
1.1	General information and notes for the reader	8
1.2	Intended use.....	9
1.3	Improper use	9
1.4	Target groups and qualifications	9
1.5	Warranty provisions.....	9
1.6	Plates and symbols	10
1.6.1	Safety- / warning symbols, note symbols.....	10
1.6.2	Name plate	11
1.7	Transport safety information.....	14
1.8	Installation safety information.....	14
1.9	Safety instructions for electrical installation	14
1.10	Safety instructions for operation.....	15
1.11	Technical limit values	15
1.12	Allowed measuring media	15
1.13	Maintenance and inspection safety information.....	16
1.14	Returning devices.....	16
1.15	Integrated management system.....	17
1.16	Disposal.....	17
1.16.1	Information on WEEE Directive 2012/19/EU (Waste Electrical and Electronic Equipment).....	17
2	Design and function	18
2.1	Measuring principle	18
2.2	Device designs	19
2.2.1	Design	20
2.2.2	Integral mount design.....	20
2.2.3	Remote mount design	21
3	Transport and storage	22
3.1	Inspection	22
3.2	Transport of flanged units smaller than DN 450.....	22
3.3	Transport of flanged units larger than DN 400	23
3.4	Storage conditions.....	23
4	Mounting	24
4.1	General information on installation.....	24
4.1.1	Supports for meter sizes larger than DN 400	24
4.1.2	Selecting gaskets	25
4.1.3	Devices with a wafer-type design	25
4.1.4	Installing the meter tube.....	26
4.2	Torque information	27
4.3	Information on 3A conformity	31
4.4	Installation Requirements.....	32
4.4.1	Flow direction	32
4.4.2	Electrode axis.....	32
4.4.3	In- and outlet pipe sections	32
4.4.4	Vertical connections	32
4.4.5	Horizontal connections.....	32
4.4.6	Free inlet or outlet	32
4.4.7	Strongly contaminated measuring media.....	32
4.4.8	Installation in the vicinity of pumps	33

4.4.9	Installation of the high temperature design	33
4.4.10	Devices with extended diagnostic functions	33
4.4.11	Minimum distance	33
4.4.12	Installation in pipelines with larger nominal diameters.....	33
4.5	Rotating the LCD display / Rotating the housing	34
4.5.1	Rotating the LCD display	35
4.5.2	Rotating the housing	35
4.6	Ground.....	35
4.6.1	General information on ground connections.....	35
4.6.2	Metal pipe with fixed flanges.....	36
4.6.3	Metal pipe with loose flanges.....	37
4.6.4	Plastic pipes, non-metallic pipes or pipes with insulating liner	38
4.6.5	Sensor type HygienicMaster	39
4.6.6	Ground for devices with protective plates.....	39
4.6.7	Ground with conductive PTFE grounding plate	39
4.6.8	Devices with extended diagnostic functions	39
4.6.9	Installation and grounding in pipelines with cathodic corrosion protection (CCP).....	40
5	Electrical connections	42
5.1	Routing the signal and magnet coil cable	42
5.2	Preparing the signal and magnet coil cable in the case of transmitters with dual-compartment housing ...	43
5.2.1	Cable with part number D173D027U01	43
5.2.2	Cable with part number D173D031U01.....	44
5.3	Preparing the signal and magnet coil cable in the case of transmitters with single-compartment housing.	45
5.3.1	Cable with part number D173D027U01	46
5.3.2	Cable with part number D173D031U01	46
5.4	Connecting the flowmeter sensor.....	47
5.4.1	Metal terminal box for ProcessMaster and HygienicMaster	47
5.4.2	Connection via cable conduit.....	48
5.4.3	IP rating IP 68	49
5.5	Connecting the transmitter	51
5.5.1	Connecting the power supply.....	51
5.5.2	Transmitter with dual-compartment housing.....	52
5.5.3	Transmitter with single-compartment housing	52
5.5.4	Connecting the signal and magnet coil cables	53
5.6	Terminal connection diagrams	54
5.6.1	HART, PROFIBUS PA and FOUNDATION fieldbus protocol.....	54
5.7	Electrical data	55
5.7.1	Current / HART output	55
5.7.2	Digital output DO1.....	55
5.7.3	Digital output DO2.....	55
5.7.4	Digital input DI.....	55
5.7.5	Digital communication	56
5.8	Connection examples.....	56
5.8.1	Digital output DO2.....	56
5.8.2	Digital outputs DO1 and DO2	56
5.8.3	PROFIBUS PA - Connection via M12 plug.....	56
6	Digital communication.....	57
6.1	HART protocol.....	57

6.1.1	System integration	57
6.2	PROFIBUS PA	57
6.2.1	Bus topology	57
6.2.2	Voltage / current consumption	57
6.2.3	System integration	57
6.3	FOUNDATION fieldbus (FF)	58
6.3.1	Bus topology	58
6.3.2	Voltage / current consumption	58
6.3.3	Bus address	58
6.3.4	System integration	58
7	Commissioning	59
7.1	Preliminary checks prior to start-up	59
7.2	Configuring the current output	59
7.2.1	Transmitter with dual-compartment housing	60
7.2.2	Transmitter with single-compartment housing	61
7.3	Start-up of PROFIBUS PA units	62
7.3.1	Local address setting in the case of transmitters with dual-compartment housing	63
7.3.2	Configuration in the case of transmitters with single-compartment housing	64
7.3.3	Voltage / current consumption	65
7.3.4	System integration	65
7.4	Start-up of FOUNDATION FIELDBUS devices	66
7.4.1	Configuration of transmitters with dual-compartment housing	67
7.4.2	Configuration of transmitters with single-compartment housing	68
7.4.3	Bus address settings	69
7.5	Commissioning the unit	70
7.5.1	Downloading the system data	70
7.5.2	Parameterization via the "Commissioning" menu function	72
7.6	Flowmeter sizes, flow range	78
8	Parameterization	79
8.1	Operation	79
8.1.1	Menu navigation	79
8.2	Menu levels	80
8.2.1	Process display	81
8.2.2	Switching to the information level (operator menu)	82
8.2.3	Switching to the configuration level (parameterization)	85
8.2.4	Hardware write protection	86
8.2.5	Selecting and changing parameters	87
8.3	Overview of parameters on the configuration level	89
8.4	Description of parameters	97
8.4.1	Menu: Easy Setup	97
8.4.2	Menu: Device Info	100
8.4.3	Menu: Device Setup	104
8.4.4	Menu: Display	108
8.4.5	Menu: Input/Output	110
8.4.6	Menu: Process Alarm	116
8.4.7	Menu: Communication	117
8.4.8	Menu: Diagnostics	122
8.4.9	Menu: Totalizer	131

Contents

8.5	Alarm Simulation	133
8.6	FEP500 and FEH500 during fill operation.....	134
8.6.1	Configuration	134
8.7	Software – history.....	137
8.7.1	Devices with HART protocol	137
8.7.2	Devices with PROFIBUS PA or FOUNDATION fieldbus	137
9	Extended diagnostic functions	138
9.1	General remarks.....	138
9.1.1	Detection of partial filling.....	138
9.1.2	Detection of gas bubbles	138
9.1.3	Electrode coating detection.....	139
9.1.4	Conductivity monitoring.....	139
9.1.5	Electrode impedance monitoring	139
9.1.6	Sensor measurements	140
9.1.7	Trend	140
9.1.8	Fingerprint	140
9.1.9	Checking the grounding	140
9.2	Performing the earthing check	141
9.3	Recommended settings for diagnostic limit values	142
9.3.1	Limit values for the coil resistance	142
9.3.2	Limit values for the electrode deposits.....	143
9.3.3	Limit values for the electrode impedance	143
9.3.4	Recommended settings for the Trend Logger	143
10	Error messages	144
10.1	Invoking the error description.....	144
10.2	Error states and alarms	145
10.2.1	Errors	145
10.2.2	Function check	146
10.2.3	Operation outside of specifications (Off Spec)	148
10.2.4	Maintenance.....	149
10.3	Overview of error states and alarms	150
10.3.1	Error messages during commissioning.....	154
11	Maintenance.....	156
11.1	Flowmeter sensor	156
11.2	Gaskets	156
11.3	Replacing the transmitter or the sensor	157
11.3.1	Transmitter	157
11.3.2	Sensor.....	158
11.3.3	Downloading the system data	159
12	Spare parts list	160
12.1	Fuses for transmitter electronics	160
12.2	Spare parts for devices with integral mount design	160
12.3	Spare parts for devices with remote mount design.....	161
12.3.1	field-mount housing.....	161
12.3.2	Round field-mount housing	161
12.3.3	Flowmeter sensor (Zone 2 / Div. 2).....	162
12.3.4	Flowmeter sensor (Zone 1 / Div. 1).....	162
13	Performance specifications	163

13.1	General.....	163
13.1.1	Reference conditions	163
13.1.2	Maximum measuring error	163
13.1.3	Reproducibility, response time	163
13.1.4	Power supply.....	163
13.2	Mechanical properties	164
13.3	IP rating	164
13.4	Vibration	164
13.5	Temperature data	164
14	Functional and technical properties - ProcessMaster	165
14.1	IP rating	165
14.2	Pipeline vibration	165
14.3	Installation length	165
14.4	Signal cable	165
14.5	Temperature data	165
14.5.1	Storage temperature	165
14.5.2	Minimum permissible pressure as a function of measuring medium temperature	165
14.5.3	Maximum permissible cleaning temperature	165
14.5.4	Maximum ambient temperature depending on measuring medium temperature	166
14.5.5	ProcessMaster with remote mount design (standard sensor design).....	167
14.5.6	Overview sensor design level "C"	168
14.6	Material load.....	168
14.6.1	Flowmeter sensor design level "B"	168
14.6.2	Flowmeter sensor design level "C"	169
14.7	Materials for flowmeter sensors	170
14.7.1	Wetted parts	170
14.7.2	Non-wetted parts (process connection)	170
14.7.3	Flowmeter sensor housing	170
15	Functional and technical properties - HygienicMaster	171
15.1	Flowmeter sensor	171
15.1.1	IP rating according to EN 60529	171
15.1.2	Pipeline vibration according to EN 60068-2-6	171
15.1.3	Installation length	171
15.1.4	Signal cable (for external transmitters only)	171
15.1.5	Temperature range	171
15.1.6	Material load.....	173
15.1.7	Mechanical properties	174
16	Appendix	175
16.1	Return form	175
16.2	Overview of parameter settings (factory settings).....	176
16.2.1	For Profibus PA version	176
16.3	Declaration of conformity.....	177

1 Safety

1.1 General information and notes for the reader

You must read these instructions carefully prior to installing and commissioning the device.

These instructions are an important part of the product and must be kept for future reference.

These instructions are intended as an overview and do not contain detailed information on all designs for this product or every possible aspect of installation, operation and maintenance.

For additional information or if specific problems occur that are not discussed in these instructions, contact the manufacturer.

The content of these instructions is neither part of any previous or existing agreement, promise or legal relationship nor is it intended to change the same.

This product is built based on state-of-the-art technology and is operationally safe. It has been tested and left the factory in perfect working order from a safety perspective. The information in the manual must be observed and followed in order to maintain this state throughout the period of operation.

Modifications and repairs to the product may only be performed if expressly permitted by these instructions.

Only by observing all of the safety instructions and all safety/warning symbols in these instructions can optimum protection of both personnel and the environment, as well as safe and fault-free operation of the device, be ensured.

Information and symbols directly on the product must be observed. They may not be removed and must be fully legible at all times.

i

IMPORTANT (NOTE)

- An additional document with Ex safety instructions is available for measuring systems that are used in explosion hazardous areas.
- Ex safety information is an integral part of this manual. As a result, it is crucial that the installation guidelines and connection values it lists are also observed.

The icon on the name plate indicates the following:



1.2 Intended use

This device is intended for the following uses:

- To transmit fluid, pulpy or pasty measurement media with electrical conductivity.
- To measure the flowrate of the operating volume or mass flow units (at constant pressure / temperature), if a mass engineering unit is selected.

The following items are included in the intended use:

- Read and follow the instructions in this manual.
- Observe the technical ratings; refer to the section 1.11 „Technical limit values“.
- Use only allowed measurement media; refer to the section 1.12 „Allowed measuring media“.

1.3 Improper use

The following are considered to be instances of improper use of the device:

- Operation as a flexible adapter in piping, e.g., to compensate for pipe offsets, pipe vibrations, pipe expansions, etc.
- As a climbing aid, e. g., for mounting purposes
- As a support for external loads, e. g., as a support for piping, etc.
- Adding material, e. g., by painting over the name plate or welding/soldering on parts
- Removing material, e. g., by spot drilling the housing

1.4 Target groups and qualifications

Installation, commissioning, and maintenance of the product may only be performed by trained specialist personnel who have been authorized by the plant operator to do so. The specialist personnel must have read and understood the manual and comply with its instructions.

Prior to using corrosive and abrasive measurement media, the operator must check the level of resistance of all parts coming into contact with the wetted parts. ABB Automation Products GmbH will gladly support you in selecting the materials, but cannot accept any liability in doing so.

The operators must strictly observe the applicable national regulations with regards to installation, function tests, repairs, and maintenance of electrical products.

1.5 Warranty provisions

Using the device in a manner that does not fall within the scope of its intended use, disregarding this instruction, using underqualified personnel, or making unauthorized alterations releases the manufacturer from liability for any resulting damage. This renders the manufacturer's warranty null and void.

1.6 Plates and symbols

1.6.1 Safety- / warning symbols, note symbols



DANGER – <Serious damage to health / risk to life>

This symbol in conjunction with the signal word "Danger" indicates an imminent danger. Failure to observe this safety information will result in death or severe injury.



DANGER – <Serious damage to health / risk to life>

This symbol in conjunction with the signal word "Danger" indicates an imminent electrical hazard. Failure to observe this safety information will result in death or severe injury.



WARNING – <Bodily injury>

This symbol in conjunction with the signal word "Warning" indicates a possibly dangerous situation. Failure to observe this safety information may result in death or severe injury.



WARNING – <Bodily injury>

This symbol in conjunction with the signal word "Warning" indicates a potential electrical hazard. Failure to observe this safety information may result in death or severe injury.



CAUTION – <Minor injury>

This symbol in conjunction with the signal word "Caution" indicates a possibly dangerous situation. Failure to observe this safety information may result in minor or moderate injury. This may also be used for property damage warnings.



NOTICE – <Property damage>!

The symbol indicates a potentially damaging situation.

Failure to observe this safety information may result in damage to or destruction of the product and/or other system components.



IMPORTANT (NOTE)

This symbol indicates operator tips, particularly useful information, or important information about the product or its further uses. It does not indicate a dangerous or damaging situation.

1.6.2 Name plate



IMPORTANT (NOTE)

An additional document with Ex safety instructions is available for measuring systems that are used in explosion hazardous areas. As a result, it is crucial that the specifications and data it lists are also observed.

1.6.2.1 Name plate for integral mount design

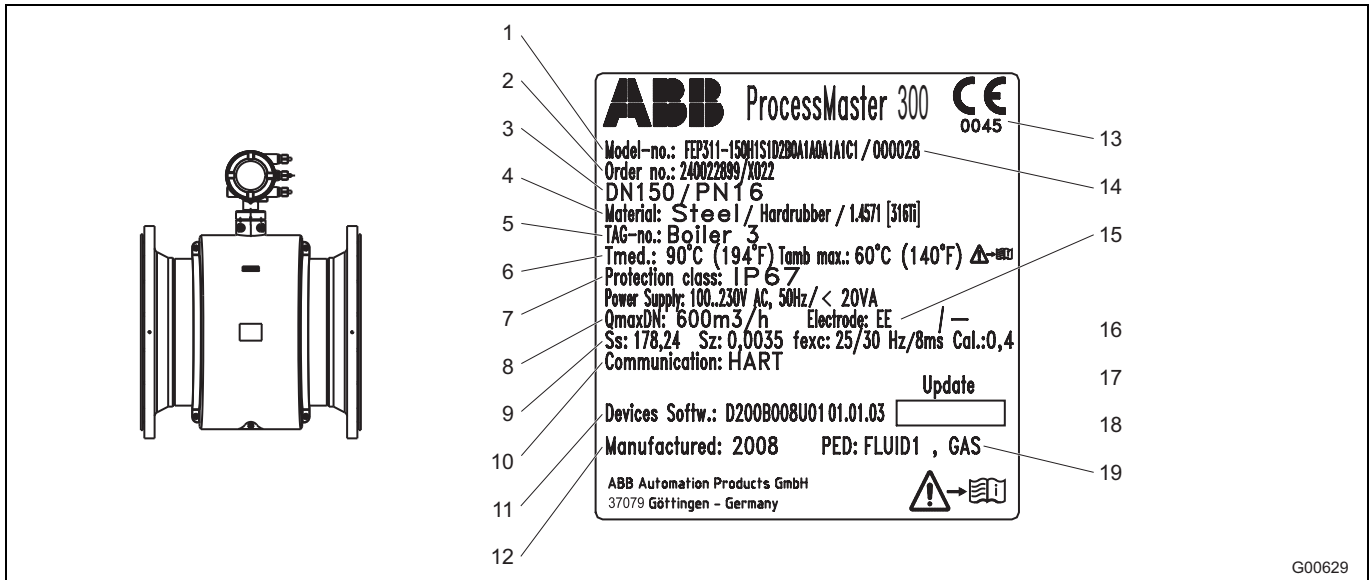

Fig. 1: Integral mount design (e.g., transmitter with dual-compartment housing)

- | | |
|---|--|
| <ul style="list-style-type: none"> 1 Model number (for more detailed information about the technical design, refer to the data sheet or the order confirmation) 2 Project number 3 Meter size and nominal pressure rating 4 Material: Flange / lining / electrode 5 Client-specific TAG number (if specified) 6 T_{med} = maximum permissible fluid temperature
T_{amb} = maximum permissible ambient temperature 7 Protection type according to EN 60529 8 Calibration value Q_{max}DN 9 Calibration value Ss (span)
Calibration value Sz (zero point) 10 Communications protocol of transmitter 11 Software version 12 Year of manufacture 13 CE mark 14 Serial number for identification by the manufacturer | <ul style="list-style-type: none"> 15 Supplementary information: EE = earthing electrodes, TFE = partial filling electrode 16 Accuracy to which the unit was calibrated (e.g., 0.2% of rate) 17 Excitation frequency of sensor coils 18 Version level (xx.xx.xx) 19 Label indicating whether the unit is subject to the Pressure Equipment Directive (PED). Information on the relevant fluid group. Fluid group 1 = hazardous fluids, liquid, gaseous. (Pressure Equipment Directive = PED). If the pressure equipment is not subject to the Pressure Equipment Directive 2014/68/EU, it is classified in accordance with SEP (= sound engineering practice) as per Art. 3 Para. 3 of the PED. If no such information is present, it means that the device does not claim to comply with the requirements of the Pressure Equipment Directive 2014/68/EU. Water supplies and connected equipment accessories are classed as an exception in accordance with guideline 1/16 of Art. 1, Para. 3.2 of the Pressure Equipment Directive. |
|---|--|



IMPORTANT (NOTE)

Meters with 3A approval are labeled with an additional plate.

1.6.2.2 Name plate for the remote mount design

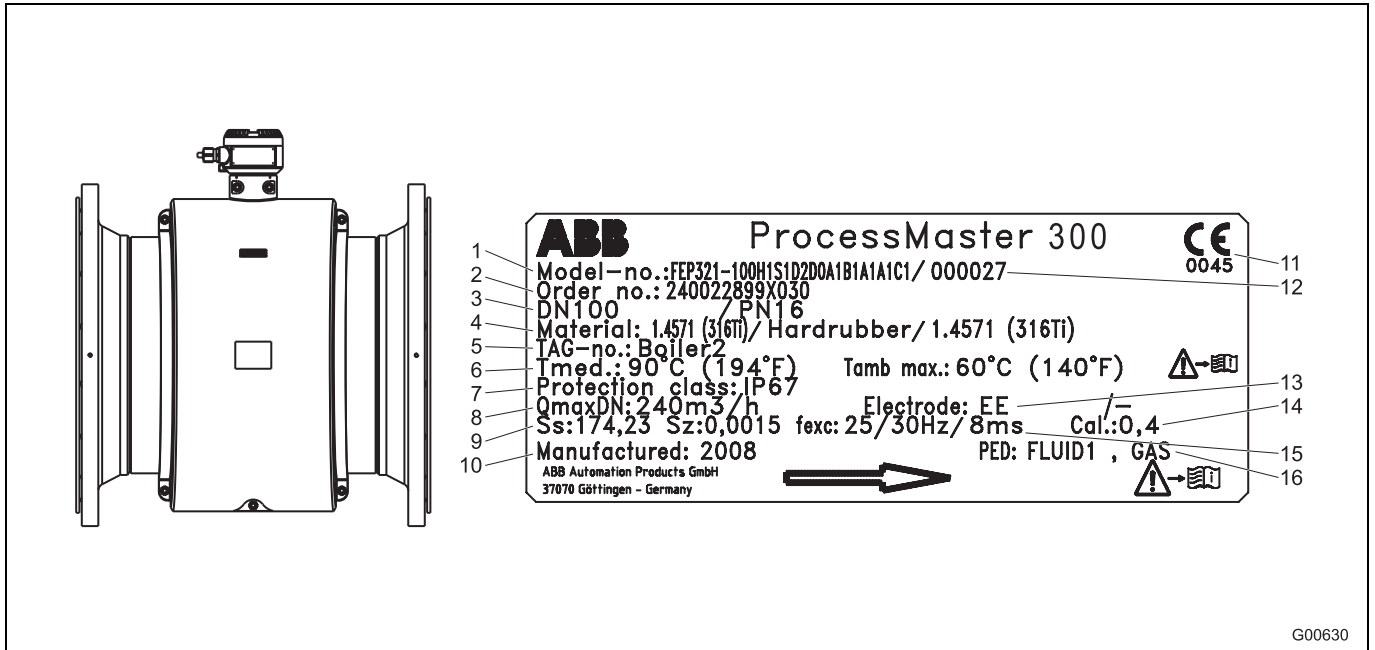

Fig. 2: Remote mount design

- | | |
|---|---|
| <ul style="list-style-type: none"> 1 Model number (for more detailed information about the technical design, refer to the data sheet or the order confirmation) 2 Project number 3 Meter size and nominal pressure rating 4 Material: Flange / lining / electrode 5 Client-specific TAG number (if specified) 6 T_{med} = maximum permissible fluid temperature
T_{amb} = maximum permissible ambient temperature 7 Protection type according to EN 60529 8 Calibration value Q_{max}DN 9 Calibration value Ss (span)
Calibration value Sz (zero point) 10 Year of manufacture 11 CE mark 12 Serial number for identification by the manufacturer | <ul style="list-style-type: none"> 13 Supplementary information: EE = earthing electrodes, TFE = partial filling electrode 14 Accuracy to which the unit was calibrated (e.g., 0.2% of rate) 15 Excitation frequency of sensor coils 16 Label indicating whether the unit is subject to the Pressure Equipment Directive (PED). Information on the relevant fluid group. Fluid group 1 = hazardous fluids, liquid, gaseous. (Pressure Equipment Directive = PED). If the pressure equipment is not subject to the Pressure Equipment Directive 2014/68/EU, it is classified in accordance with SEP (= sound engineering practice) as per Art. 3 Para. 3 of the PED. If no such information is present, it means that the device does not claim to comply with the requirements of the Pressure Equipment Directive 2014/68/EU. Water supplies and connected equipment accessories are classed as an exception in accordance with guideline 1/16 of Art. 1, Para. 3.2 of the Pressure Equipment Directive. |
|---|---|



IMPORTANT (NOTE)

Meters with 3A approval are labeled with an additional plate.

1.6.2.3 Name plate for remote transmitter

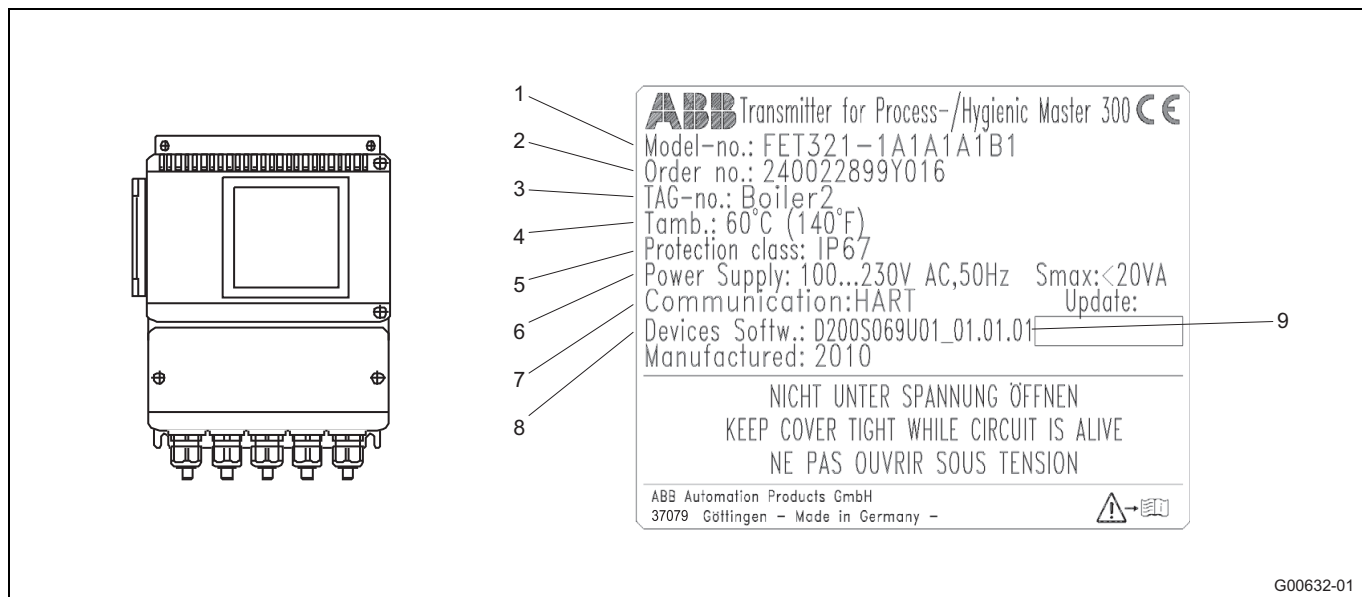

Fig. 3: Remote transmitter (e.g., transmitter with dual-compartment housing)

- | | |
|--|--|
| 1 Model number (for more detailed information about the technical design, refer to the data sheet or the order confirmation) | 5 Protection type according to EN 60529 |
| 2 Project number | 6 Supply voltage |
| 3 Client-specific TAG number (if specified) | 7 Communications protocol of transmitter |
| 4 T _{amb} = maximum permissible ambient temperature | 8 Software version |
| | 9 Version level (xx.xx.xx) |

1.7 Transport safety information

- Depending on the device, the center of gravity may not be in the center of the equipment.
- The protection plates or protective caps installed on the process connections of devices lined with PTFE / PFA must not be removed until just before installation; to prevent possible leakage, make sure that the liner on the flange is not cut or damaged.

1.8 Installation safety information

Observe the following instructions:

- The flow direction must correspond to the direction indicated on the device, if labeled.
- Comply with the maximum torque for all flange bolts.
- Install the devices without mechanical tension (torsion, bending).
- Install flange and wafer type units with coplanar counter flanges.
- Only install devices for the intended operating conditions and with suitable seals.
- Secure the flange bolts and nuts against pipeline vibrations.

1.9 Safety instructions for electrical installation

Electrical connections may only be established by authorized specialist personnel in accordance with the electrical circuit diagrams.

The electrical connection information in the manual must be observed; otherwise, the type of electrical protection may be adversely affected.

Ground the flowmeter and the sensor housing.

The line for the supply power must be installed according to the relevant national and international standards. A separate fuse must be connected upstream and in close proximity to each unit. The fuses must be identified accordingly. The rated current of the circuit breaker must not exceed 16 A.

The unit has a protection class of I and overvoltage class II (IEC664).

The power supply and the electrical circuit for the coils of the flowmeter sensor are dangerous and pose a contact risk.

The coil and signal circuit may be connected with the corresponding ABB flowmeter sensors only. Use the supplied cable.

Only electrical circuits that do not pose a contact risk can be connected to the remaining signal inputs and outputs.

1.10 Safety instructions for operation

During operation with hot fluids, contact with the surface may result in burns.

Aggressive fluids may result in corrosion or abrasion of the parts that come into contact with the medium. As a result, pressurized fluids may escape prematurely.

Wear to the flange gasket or process connection gaskets (e.g., aseptic threaded pipe connections, Tri-Clamp, etc.) may enable a pressurized medium to escape.

When using internal flat gaskets, these can become embrittled through CIP/SIP processes.

If pressure shocks exceeding the device's permissible nominal pressure occur continuously during operation, this can have a detrimental effect on the device's service life.

1.11 Technical limit values

The device is designed for use exclusively within the stated values on the name plate and within the technical limit values specified in the data sheets.

The following technical limit values must be observed:

- The permissible operating pressure (PS) in the permissible temperature (TS) may not exceed the pressure-temperature ratings.
- The maximum operating temperature may not be exceeded.
- The permitted operating temperature may not be exceeded.
- The housing protection system must be observed.
- The flowmeter sensor may not be operated in the vicinity of powerful electromagnetic fields, e.g., motors, pumps, transformers, etc. A minimum spacing of approx. 1 m (3.28 ft) should be maintained. For installation on or to steel parts (e.g., steel brackets), a minimum spacing of approx. 100 mm (3.94 inch) should be maintained (based on IEC801-2 and IECTC77B).

1.12 Allowed measuring media

When using measuring media, the following points must be observed:

- Measuring media (fluids) may only be used if it can be ensured that the chemical and physical properties—which are required for operational security—of the components coming into contact with the media are not affected during the operating life. This can be achieved through the use of state-of-the-art technology or the operating experience of the operator. Components coming into contact with the media include measuring electrodes, lining, and, if applicable, earth electrodes, mating parts, protective washers or protective flanges
- Measuring media with unknown properties or abrasive measuring media may only be used if the operator is able to perform regular and suitable tests to ensure the safe condition of the device
- The information on the name plate must be observed

1.13 Maintenance and inspection safety information

**WARNING – Risk to persons!**

When the housing cover is open, EMC and protection against contact are suspended. There are electric circuits within the housing which pose a contact risk. The auxiliary power must be switched off before opening the housing cover.

**WARNING – Risk to persons!**

The inspection screw (for draining condensate fluid) for devices \geq DN 450 can be under pressure. The fluid which spurts out can cause severe injuries. Depressurize pipes before opening the inspection screw.

Corrective maintenance work may only be performed by trained personnel.

- Depressurize the device and adjoining lines or containers before removing the device.
- Check whether hazardous materials are used as materials to be measured before opening the device. Residual amounts of hazardous material may still be present in the device and could escape when the device is opened.
- As far as provided in the scope of the operational responsibility, check the following items through a regular inspection:
 - the pressure-carrying walls / lining of the pressure device
 - the measurement-related function
 - the leak tightness
 - the wear (corrosion)

1.14 Returning devices

Use the original packaging or suitably secure shipping containers if you need to return the device for repair or recalibration purposes. Fill out the return form (see the Appendix) and include this with the device.

According to EC guidelines for hazardous materials, the owner of hazardous waste is responsible for its disposal or must observe the following regulations for shipping purposes:

All devices delivered to ABB Automation Products GmbH must be free from any hazardous materials (acids, alkalis, solvents, etc.).

Rinse out and neutralize hazardous materials from all hollow spaces such as between meter tube and housing. For flowmeters larger than DN 400, the service screw (for draining condensate fluid) at the lower point of the housing must be opened to dispose of hazardous substances and to neutralize the coil and electrode chamber. These activities must be confirmed in writing using the return form.

Please contact Customer Center Service acc. to page 2 for nearest service location.

1.15 Integrated management system

ABB Automation Products GmbH operates an integrated management system, consisting of:

- Quality management system to ISO 9001
- Environmental management system to ISO 14001
- Occupational health and safety management system to BS OHSAS 18001 and
- Data and information protection management system

Environmental awareness is an important part of our company policy.

Our products and solutions are intended to have a minimal impact on the environment and on people during manufacturing, storage, transport, use, and disposal.

This includes the environmentally-friendly use of natural resources. We conduct an open dialog with the public through our publications.

1.16 Disposal

This product is manufactured from materials that can be reused by specialist recycling companies.

1.16.1 Information on WEEE Directive 2012/19/EU (Waste Electrical and Electronic Equipment)

This product is not subject to WEEE Directive 2012/19/EU or relevant national laws (e.g., ElektroG in Germany).

The product must be disposed of at a specialist recycling facility. Do not use municipal garbage collection points. According to the WEEE Directive 2012/19/EU, only products used in private applications may be disposed of at municipal garbage facilities. Proper disposal prevents negative effects on people and the environment, and supports the reuse of valuable raw materials.

If it is not possible to dispose of old equipment properly, ABB Service can accept and dispose of returns for a fee.

2 Design and function

2.1 Measuring principle

Measurements performed by the electromagnetic flowmeter are based on Faraday's law of induction. A voltage is generated in a conductor when it moves through a magnetic field.

This principle is applied to a conductive fluid in the measuring tube through which a magnetic field is generated perpendicular to the flow direction (see schematic).

The voltage induced in the fluid is measured by two electrodes located diametrically opposite each other. This signal voltage U_E is proportional to the magnetic induction B , the electrode spacing D and the average flow velocity v .

Considering that the magnetic induction B and the electrode spacing D are constant values, a proportionality exists between the signal voltage U_E and the average flow velocity v . From the equation for calculating the volume flowrate, it follows that the signal voltage is linearly proportional to the volume flowrate: $U_E \sim q_v$.

The induced voltage is converted by the transmitter to standardized, analog and digital signals.

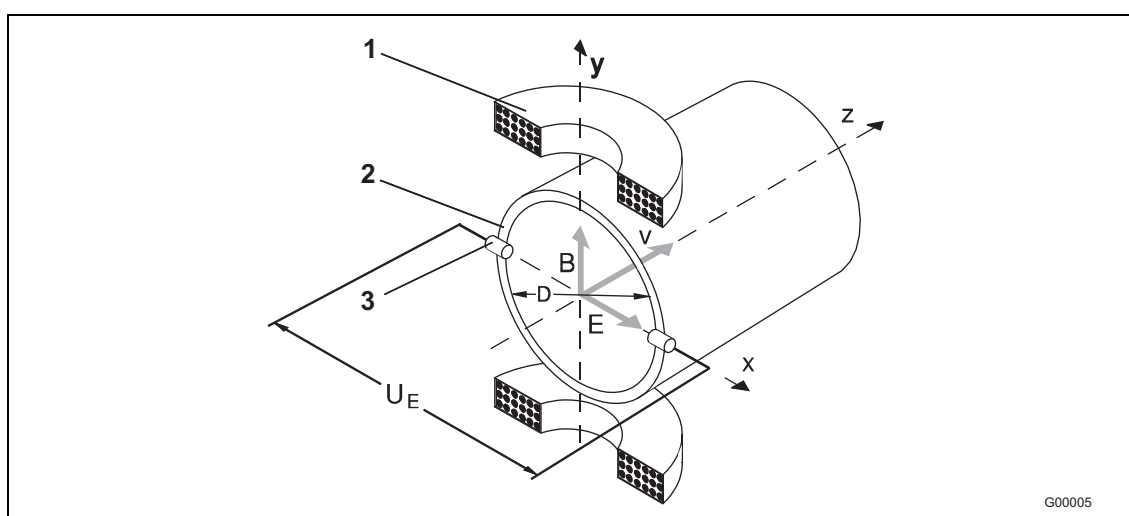

Fig. 4: Electromagnetic flowmeter schematic

- 1 Magnet coil
- 2 Measuring tube in electrode plane
- 3 Signal electrode
- U_E Signal voltage
- B Magnetic induction
- D Electrode spacing
- v Average flow velocity
- q_v Volume flow

$$U_E \sim B \cdot D \cdot v$$

$$q_v = \frac{D^2 \pi}{4} \cdot v$$

$$U_E \sim q_v$$

2.2 Device designs



IMPORTANT (NOTE)

An additional document with Ex safety instructions is available for measuring systems that are used in explosion hazardous areas. As a result, it is crucial that the specifications and data it lists are also observed.

ProcessMaster / HygienicMaster is available in two series.

ProcessMaster / HygienicMaster 300 with basic functionality and ProcessMaster / HygienicMaster 500 with extended functions and options. The following table gives an overview.

	ProcessMaster		HygienicMaster	
	FEP300	FEP500	FEH300	FEH500
Measuring accuracy 0.4 % (optional 0.2 %) of rate	X	-	X	-
Measuring accuracy 0,3 % (optional 0.2 %) of rate	-	X	-	X
Batch functions Presetting counter, overrun correction, external start/stop, batch end contact	-	X	-	X
Other software functions Mass units, editable totalizers,	X	X	X	X
Two measuring ranges	-	X	-	X
Graphic display Line recorder function	X	X	X	X
Diagnostic functions Detection of gas bubbles or deposits on electrodes, conductivity monitoring, temperature monitoring, finger print, trend	-	X	-	X
Partially filled Recognition through partial filling electrode (TFE)	X	X	-	-
Hardware options • Ceramic carbide lining • Wolfram carbide electrodes • Double layer electrodes	-	X	-	-
Hardware options DN 1 ... 2	-	-	-	X
Startup functions Grounding check	-	X	-	X
Fieldbus PROFIBUS PA, FOUNDATION fieldbus	X	X	X	X
Verifications / Diagnostic tool ScanMaster	X	X	X	X

Design and function

2.2.1 Design

An electromagnetic flowmeter system consists of a sensor and a transmitter. The sensor is installed in the specified pipeline while the transmitter is mounted locally or at a central location.

2.2.2 Integral mount design

For devices with an integral mount design, the transmitter and the sensor form a single mechanical unit.

The transmitter is available in two housing designs:

- **Single-compartment housing:**
On the single-compartment housing, the electronics area and the connection area in the transmitter are not separated from each other.
- **Dual-compartment housing:**
On the dual-compartment housing, the electronics area and the connection area in the transmitter are separated from each other.

ProcessMaster

The ProcessMaster sensor is available in two designs, which are distinguished by the design level.

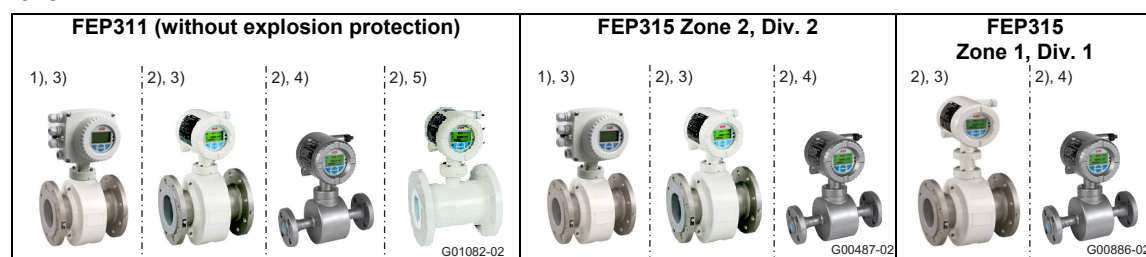

Fig. 5: ProcessMaster versions (example)

- 1) Single-compartment housing.
- 2) Dual-compartment housing.
- 3) Design level "B" sensor.
- 4) Design level "B" sensor, versions made from stainless steel
- 5) Design level "C" sensor, nominal diameter: DN 25 ... 600

HygienicMaster



Fig. 6: HygienicMaster versions (example)

- 1) Single-compartment housing.
- 2) Dual-compartment housing.

2.2.3 Remote mount design

For devices with a remote mount design, the transmitter and sensor are mounted in separate locations. The electrical connection between the transmitter and the sensor is provided by a signal cable.

When the minimum conductivity of the measuring medium is 5 µS/cm, a maximum signal cable length of 50 m (164 ft) is possible without fitting an additional preamplifier to the sensor. With a pre-amplifier, the maximum permissible signal cable length is 200 m (656 ft).

The transmitter is available in two housing designs:

- **Single-compartment housing:**
On the single-compartment housing, the electronics area and the connection area in the transmitter are not separated from each other.
- **Dual-compartment housing:**
On the dual-compartment housing, the electronics area and the connection area in the transmitter are separated from each other.

ProcessMaster

The ProcessMaster sensor is available in two designs, which are distinguished by the design level.

Sensor					
FEP321 / FEP521 (without explosion protection) 1) 2) G01083-02		FEP325 / FEP525 Zone 2, Div. 2 1) G00489-01		FEP325 / FEP525 Zone 1, Div. 1 1) G00489-01	
Transmitter					
FET321 / FET521 (without explosion protection) 3) 4) G01084-02		FET325 / FET525 (Zone 2, Div. 2) 3) 4) G01084-02		FET321 / FET521 (without explosion protection) 3) 4) G01084-02	
FET325 / FET525 (Zone 1, Div. 1) 4) G00863-02		FET325 / FET525 (Zone 2, Div. 2) 3) 4) G01084-02		FET321 / FET521 (without explosion protection) 3) 4) G01084-02	

HygienicMaster

Sensor		
FEH321 / FEH521 (without explosion protection) G00576	FEH325 / FEH525 (Zone 2, Div. 2) G00576	
Transmitter		
FET321 / FET521 (without explosion protection) 3) 4) G01084-02	FET325 / FET525 (Zone 2, Div. 2) 3) 4) G01084-02	FET321 / FET521 (without explosion protection) 3) 4) G01084-02

- 1) Design level "B" sensor.
- 2) Design level "C" sensor, DN 25 ... 600.
- 3) Single-compartment housing.
- 4) Dual-compartment housing.

3 Transport and storage

3.1 Inspection

Check the devices for possible damage that may have occurred during transport. Damages in transit must be recorded on the transport documents. All claims for damages must be claimed without delay against the shipper and before the installation.

3.2 Transport of flanged units smaller than DN 450



WARNING – Danger of injuries due to slipping meter.

The center of gravity for the complete device may be higher than the lifting straps. Make sure the device has not rotated or slipped unintentionally during transport. Support the meter laterally.

For transport of flanged units smaller than DN 450 use a lifting strap. Wrap the straps around both process connections when lifting the device. Avoid chains since these may damage the housing.

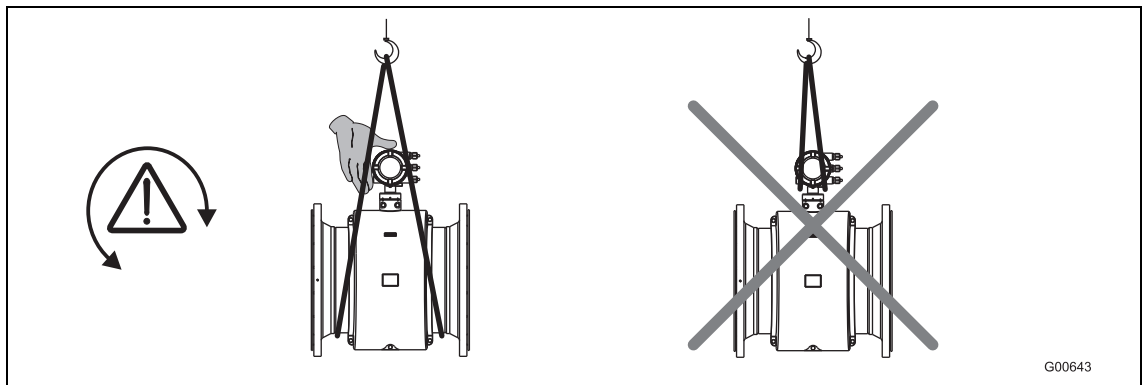

Fig. 7: Transport of flanged units smaller than DN 450

3.3 Transport of flanged units larger than DN 400

**NOTICE - Potential damage to device!**

Use of a forklift to transport the device can bend the housing and damage the internal magnet coils.

Flanged units may not be lifted at the middle of the housing when transporting via forklift.

Flanged units may not be lifted by the terminal box or at the middle of the housing. Use only the eye bolts on the device to lift and install it in the pipeline.

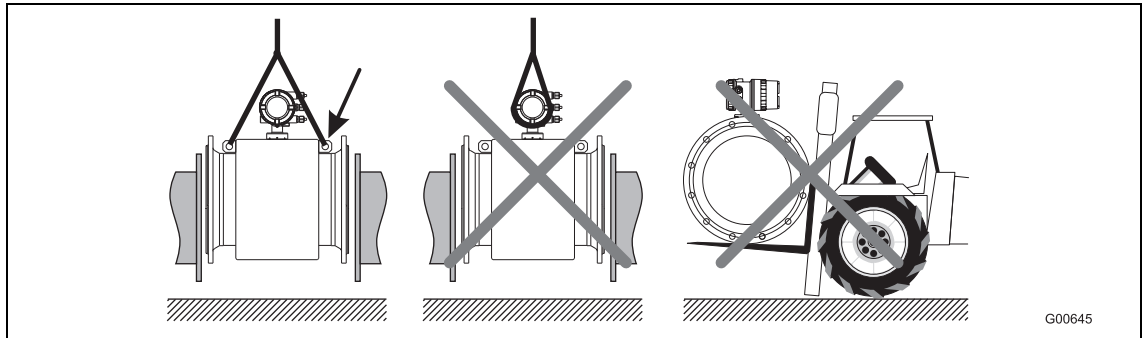

Fig. 8: Transport of flanged units larger than DN 400

3.4 Storage conditions

When storing the unit, please note the following points.

- Store the unit in its original packaging in a dry and dust-free location.
- Avoid storing the unit in direct sunlight.

4 Mounting



IMPORTANT (NOTE)

An additional document with Ex safety instructions is available for measuring systems that are used in explosion hazardous areas. As a result, it is crucial that the specifications and data it lists are also observed.

4.1 General information on installation

The following points must be observed during installation:

- The flow direction must correspond to the marking, if present
- The maximum torque for all flange screws must be complied with
- The devices must be installed without mechanical tension (torsion, bending)
- Install flange devices / wafer-type devices with plane parallel counterflanges and use appropriate gaskets only
- Only gaskets made from a material that is compatible with the measuring medium and measuring medium temperature may be used
- Gaskets must not extend into the flow area, since possible turbulence could influence the accuracy of the device
- The piping may not exert any inadmissible forces or torques on the device
- Do not remove the sealing plugs in the cable glands until you are ready to install the electrical cable
- Make sure the gaskets for the housing cover are seated correctly. Carefully gasket the cover. Tighten the cover fittings
- The transmitter with a remote mount design must be installed at a largely vibration-free location
- Do not expose the transmitter and sensor to direct sunlight. Provide appropriate sun protection as necessary
- When installing the transmitter in a control cabinet, make sure adequate cooling is provided
- For devices with a remote mount design and a measuring accuracy of 0.2 % of the measured value, make sure that the sensor and the transmitter have been correctly assigned. Compatible devices have the same end numbers on the name plate, e.g. X001 and Y001 or X002 and Y002

4.1.1 Supports for meter sizes larger than DN 400



NOTICE - Potential damage to device!

Improper support for the device may result in deformed housing and damage to internal magnet coils.

Place the supports at the edge of the housing (see arrows in the figure).

Devices with meter sizes larger than DN 400 must be mounted with support on a sufficiently strong foundation.

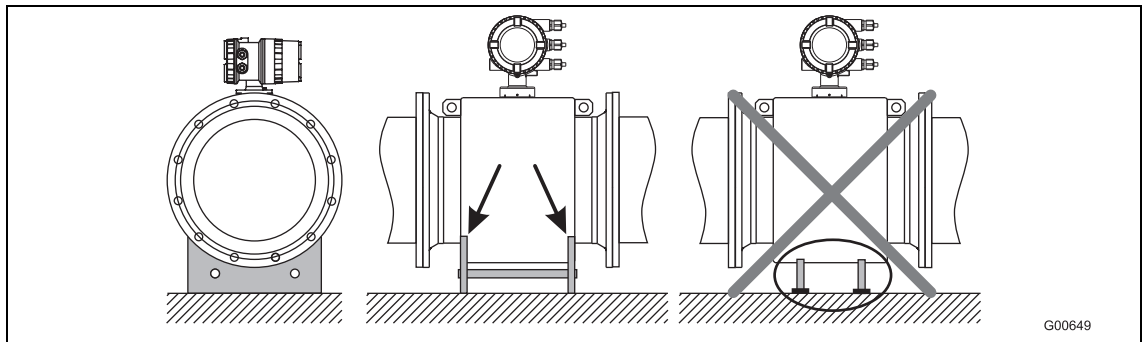

Fig. 9: Support for meter sizes larger than DN 400

4.1.2 Selecting gaskets

The following points must be observed when installing gaskets:

Devices with a hard rubber, soft rubber or ceramic carbide liner

- Devices with a hard / soft rubber liner always require additional gaskets
- ABB recommends using gaskets made from rubber or rubber-like sealing materials
- When selecting the gaskets, ensure that the tightening torques specified in chapter „Torque information“ on page 27 are not exceeded

Devices with a PTFE, PFA or ETFE liner

- In principle, devices with a PTFE, PFA or ETFE liner do not require additional gaskets

4.1.3 Devices with a wafer-type design

For devices with a wafer-type design, ABB offers an installation set as an accessory that comprises threaded rods, nuts, washers and centering sleeves for installation.

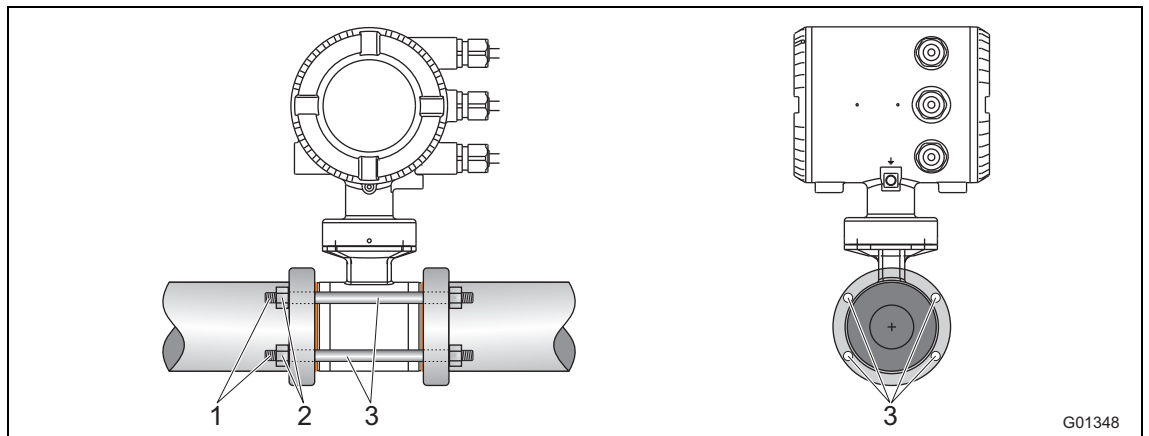

Fig. 10: Installation set for wafer-type installation

- | | |
|-------------------|---------------------|
| 1 Threaded rod | 3 Centering sleeves |
| 2 Nut with washer | |

4.1.4 Installing the meter tube



Notice – potential damage to device!

The use of graphite with the flange or process connection gaskets is prohibited. This is because, in some instances, an electrically conductive coating may form on the inside of the meter tube. Vacuum shocks in the piping should be avoided to prevent damage to the liners (PTFE). Vacuum shocks can destroy the device.

The meter tube can be installed at any location in the piping while taking the installation conditions into account.

1. Remove protective plates, if present, to the right and left of the meter tube. To prevent possible leakage, make sure that the liner on the flange is not cut or damaged.
2. Position the meter tube coplanar and centered between the piping.
3. Install gaskets between the surfaces; see chapter „Torque information“ on page 27.



IMPORTANT (NOTE)

For achieve the best results, ensure the gaskets fit concentrically with the meter tube

4. Use the appropriate screws for the holes in accordance with chapter „Torque information“ on page 27.
5. Slightly grease the threaded nuts.
6. Tighten the nuts in a crosswise manner as shown in the figure. Observe the tightening torques in accordance with chapter „Selecting gaskets“ on page 25!
First tighten the nuts to approx. 50 % of the maximum torque, then to 80 %, and finally a third time to the maximum torque. Do not exceed the max. torque.

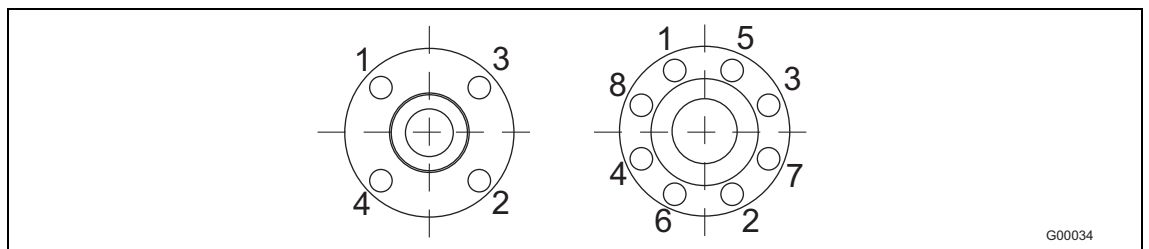

Fig. 11

4.2 Torque information

IMPORTANT (NOTE)

The specified torques are valid only for greased threads and piping that is not subject to tensile stress.

ProcessMaster in flange design and HygienicMaster in flange or wafer-type design

Nominal diameter [mm (inch)]	Nominal pressure rating	Maximum tightening torque [Nm]					
		Hard / soft rubber		PTFE, PFA, ETFE		Ceramic carbide	
		2)	3)	2)	3)	2)	3)
DN 3 ... 101 (1/10 ... 3/8"1))	PN40	–	–	12,43	12,43	–	–
	PN63/100	–	–	12,43	12,43	–	–
	CL150	–	–	12,98	12,98	–	–
	CL300	–	–	4,94	17,38	–	–
	JIS 10K	–	–	12,43	12,43	–	–
DN 15 (1/2")	PN40	6,74	4,29	14,68	14,68	–	–
	PN63/100	13,19	11,2	22,75	22,75	–	–
	CL150	3,65	3,65	12,98	12,98	–	–
	CL300	4,94	3,86	4,94	17,38	–	–
	CL600	9,73	9,73	–	–	–	–
DN 20 (3/4")	JIS 10K	2,84	1,37	14,68	14,68	–	–
	PN40	9,78	7,27	20,75	20,75	–	–
	PN63/100	24,57	20,42	42,15	42,15	–	–
	CL150	5,29	5,29	18,49	18,49	–	–
	CL300	9,77	9,77	33,28	33,28	–	–
DN 25 (1")	CL600	15,99	15,99	–	–	–	–
	JIS 10K	4,1	1,88	20,75	20,75	–	–
	PN40	13,32	8,6	13,32	8,6	13,32	8,6
	PN63/100	32,09	31,42	53,85	53,85	53,85	53,85
	CL150	5,04	2,84	23,98	23,98	23,98	23,98
DN 32 (1 1/4")	CL300	17,31	16,42	65,98	38,91	65,98	38,91
	CL600	22,11	22,11	–	–	–	–
	JIS 10K	8,46	5,56	26,94	26,94	26,94	26,94
	PN40	27,5	15,01	45,08	45,08	45,08	45,08
	PN63/100	42,85	41,45	74,19	70,07	74,19	70,07
DN 40 (1 1/2")	CL150	4,59	1,98	29,44	29,44	29,44	29,44
	CL300	25,61	14,22	45,52	45,52	45,52	45,52
	CL600	34,09	34,09	–	–	–	–
	JIS 10K	9,62	4,9	45,08	45,08	45,08	45,08
	PN40	30,44	23,71	56,06	56,06	56,06	56,06
DN 50 (1 1/2")	PN63/100	62,04	51,45	97,08	97,08	97,08	97,08
	CL150	5,82	2,88	36,12	36,12	36,12	36,12
	CL300	33,3	18,41	73,99	73,99	73,99	73,99
	CL600	23,08	23,08	–	–	–	–
	JIS 10K	12,49	6,85	56,06	56,06	56,06	56,06
DN 50 (1 1/2")	PN40	41,26	27,24	71,45	71,45	71,45	71,45
	PN63	71,62	60,09	109,9	112,6	109,9	112,6
	CL150	22,33	22,33	66,22	66,22	66,22	66,22
	CL300	17,4	22,33	38,46	38,46	38,46	38,46
	CL600	35,03	35,03	–	–	–	–
	JIS 10K	17,27	10,47	71,45	71,45	71,45	71,45

Continued on next page

- 1) Connection flange DIN / EN1092-1 = DN 10 (3/8"), connection flange ASME = DN 15 (1/2").
- 2) Flange material: steel.
- 3) Flange material: stainless steel.

Nominal diameter [mm (inch)]	Nominal pressure rating	Maximum tightening torque [Nm]					
		Hard / soft rubber		PTFE, PFA, ETFE		Ceramic carbide	
		2)	3)	2)	3)	2)	3)
DN 65 (2 1/2")	PN16	14,94	8	37,02	39,1	37,02	39,1
	PN40	30,88	21,11	43,03	44,62	43,03	44,62
	PN63	57,89	51,5	81,66	75,72	81,66	75,72
	CL150	30,96	30,96	89,93	89,93	89,93	89,93
	CL300	38,38	27,04	61,21	61,21	61,21	61,21
	CL600	53,91	53,91	–	–	–	–
	JIS 10K	14,94	8	37,02	39,1	37,02	39,1
DN 80 (3")	PN40	38,3	26,04	51,9	53,59	51,9	53,59
	PN63	63,15	55,22	64,47	80,57	64,47	80,57
	CL150	19,46	19,46	104,6	104,6	104,6	104,6
	CL300	75,54	26,91	75,54	75,54	75,54	75,54
	CL600	84,63	84,63	–	–	–	–
	JIS 10K	16,26	9,65	45,07	47,16	45,07	47,16
DN 100 (4")	PN16	20,7	12,22	49,68	78,19	49,68	78,19
	PN40	67,77	47,12	78,24	78,19	78,24	78,19
	PN63	107,4	95,79	148,5	119,2	148,5	119,2
	CL150	17,41	7,82	76,2	76,2	76,2	76,2
	CL300	74,9	102,6	102,6	102,6	102,6	102,6
	CL600	147,1	147,1	–	–	–	–
	JIS 10K	20,7	12,22	49,68	78,19	49,68	78,19
DN 125 (5")	PN16	29,12	18,39	61,4	64,14	61,4	64,14
	PN40	108,5	75,81	123,7	109,6	123,7	109,6
	PN63	180,3	164,7	242,6	178,2	242,6	178,2
	CL150	24,96	11,05	98,05	98,05	98,05	98,05
	CL300	81,64	139,4	139,4	139,4	139,4	139,4
	CL600	244,1	244,1	–	–	–	–
DN 150 (6")	PN16	46,99	23,7	81,23	85,08	81,23	85,08
	PN40	143,5	100,5	162,5	133,5	162,5	133,5
	PN63	288,7	269,3	371,3	243,4	371,3	243,4
	CL150	30,67	13,65	111,4	111,4	111,4	111,4
	CL300	101,4	58,4	123,6	123,6	123,6	123,6
	CL600	218,4	218,4	–	–	–	–
DN 200 (8")	PN10	45,57	27,4	113	116,9	113	116,9
	PN16	49,38	33,82	70,42	73	70,42	73
	PN25	100,6	69,17	109,9	112,5	109,9	112,5
	PN40	196,6	144,4	208,6	136,8	208,6	136,8
	PN63	350,4	331,8	425,5	282,5	425,5	282,5
	CL150	49,84	23,98	158,1	158,1	158,1	158,1
	CL300	133,9	78,35	224,3	224,3	224,3	224,3
	CL600	391,8	391,8	–	–	–	–
DN 250 (10")	PN10	23,54	27,31	86,06	89,17	86,06	89,17
	PN16	88,48	61,71	99,42	103,1	99,42	103,1
	PN25	137,4	117,6	166,5	133,9	166,5	133,9
	PN40	359,6	275,9	279,9	241	279,9	241
	CL150	55,18	27,31	146,1	148,3	146,1	148,3
	CL300	202,7	113,2	246,4	246,4	246,4	246,4

Continued on next page

- 2) Flange material: steel.
- 3) Flange material: stainless steel.

Nominal diameter [mm (inch)]	Nominal pressure rating	Maximum tightening torque [Nm]					
		Hard / soft rubber		PTFE, PFA, ETFE		Ceramic carbide	
		2)	3)	2)	3)	2)	3)
DN 300 (12")	PN10	58,79	38,45	91,29	94,65	91,29	94,65
	PN16	122,4	85,64	113,9	114,8	113,9	114,8
	PN25	180,6	130,2	151,1	106,9	151,1	106,9
	PN40	233,4	237,4	254,6	252,7	254,6	252,7
	CL150	90,13	50,37	203,5	198	203,5	198
	CL300	333,3	216,4	421,7	259,1	421,7	259,1
DN 350 (14")	PN10	69,62	47,56	72,49	75,22	72,49	75,22
	PN16	133,6	93,61	124,9	104,4	124,9	104,4
	PN25	282,3	204,3	226,9	167,9	226,9	167,9
	CL150	144,8	83,9	270,5	263	270,5	263
	CL300	424,1	252,7	463,9	259,4	463,9	259,4
DN 400 (16")	PN10	108,2	75,61	120,1	113,9	120,1	113,9
	PN16	189	137,2	191,4	153,8	191,4	153,8
	PN25	399,4	366	404	246,7	404	246,7
	CL150	177,6	100	229,3	222,8	229,3	222,8
	CL300	539,5	318,8	635,8	328,1	635,8	328,1
DN 450 (18")	CL150	218,6	120,5	267,3	192,3	267,3	192,3
	CL300	553,8	327,2	660,9	300	660,9	300
DN 500 (20")	PN10	141,6	101,4	153,9	103,5	153,9	103,5
	PN16	319,7	245,4	312,1	224,8	312,1	224,8
	PN25	481,9	350,5	477,1	286	477,1	286
	CL150	212,5	116	237,3	230,4	237,3	230,4
	CL300	686,3	411,8	786,8	363,1	786,8	363,1
DN 600 (24")	PN10	224,7	164,8	238,7	149,1	238,7	149,1
	PN16	515,1	399,9	496,7	365,3	496,7	365,3
	PN25	826,2	600,3	750,7	539,2	750,7	539,2
	CL150	356,6	202,8	451,6	305,8	451,6	305,8
	CL300	1188	719	1376	587,4	1376	587,4
DN 700 (28")	PN10	267,7	204,9	On request	On request	267,7	204,9
	PN16	455,7	353,2	On request	On request	455,7	353,2
	PN25	905,9	709,2	On request	On request	905,9	709,2
	CL150	364,1	326,2	449,2	432,8	364,1	326,2
	CL300	1241	On request	On request	On request	1241	On request
DN 750 (30")	CL150	423,8	380,9	493,3	442	423,8	380,9
	CL300	1886	On request	On request	On request	1886	On request
DN 800 (32")	PN10	391,7	304,2	On request	On request	391,7	304,2
	PN16	646,4	511,8	On request	On request	646,4	511,8
	PN25	1358	1087	On request	On request	1358	1087
	CL150	410,8	380,9	493,3	380,9	410,8	380,9
	CL300	2187	On request	On request	On request	2187	On request
DN 900 (36")	PN10	387,7	296,3	On request	On request	387,7	296,3
	PN16	680,8	537,3	On request	On request	680,8	537,3
	PN25	1399	1119	On request	On request	1399	1119
	CL150	336,2	394,6	511	458,5	336,2	394,6
	CL300	1972	On request	On request	On request	1972	On request

Continued on next page

- 2) Flange material: steel.
- 3) Flange material: stainless steel.

Nominal diameter [mm (inch)]	Nominal pressure rating	Maximum tightening torque [Nm]					
		Hard / soft rubber		PTFE, PFA, ETFE		Ceramic carbide	
		2)	3)	2)	3)	2)	3)
DN 1000 (40")	PN10	541,3	419,2	On request	On request	541,3	419,2
	PN16	955,5	756,1	On request	On request	955,5	756,1
	PN25	2006	1612	On request	On request	2006	1612
	CL150	654,2	598,8	650,6	385,1	654,2	598,8
	CL300	2181	On request	On request	On request	2181	On request
DN 1100 (44")	CL150	749,1	682,6	741,3	345,9	–	–
	CL300	2607	On request	On request	On request	–	–
DN 1200 (48")	PN 6	363,5	On request	–	–	–	–
	PN10	705,9	On request	–	–	–	–
	PN16	1464	On request	–	–	–	–
	CL150	815,3	731,6	–	–	–	–
	CL300	3300	On request	–	–	–	–
DN 1350 (54")	CL150	1036	983,7	–	–	–	–
	CL300	5624	On request	–	–	–	–
DN 1400 (56")	PN 6	515	On request	–	–	–	–
	PN10	956,3	On request	–	–	–	–
	PN16	1558	On request	–	–	–	–
DN 1500 (60")	CL150	1284	1166	–	–	–	–
	CL300	6139	On request	–	–	–	–
DN 1600 (64")	PN 6	570,7	On request	–	–	–	–
	PN10	1215	On request	–	–	–	–
	PN16	2171	On request	–	–	–	–
DN 1800 (72")	PN 6	708,2	On request	–	–	–	–
	PN10	1492	On request	–	–	–	–
	PN16	2398	On request	–	–	–	–
DN 2000 (80")	PN 6	857,9	On request	–	–	–	–
	PN10	1840	On request	–	–	–	–
	PN16	2860	On request	–	–	–	–

Continued on next page

- 2) Flange material: steel.
- 3) Flange material: stainless steel.

Variable process connections HygienicMaster

Nominal diameter		Max. tightening torque
[mm]	[inch]	[Nm]
DN 1 ... 2	1/25 ... 3/32"	PVC / POM: 0.2 brass / 1.4571: 3
DN 3 ... 10	3/8"	8
DN 15	1/2"	10
DN 20	3/4"	21
DN 25	1	31
DN 32	1 1/4"	60
DN 40	1 1/2"	80
DN 50	2	5
DN 65	2 1/2"	5
DN 80	3	15
DN 100	4	14

4.3 Information on 3A conformity



IMPORTANT (NOTE)

If concentric reducers are installed on the device, it must be mounted in a vertical position.

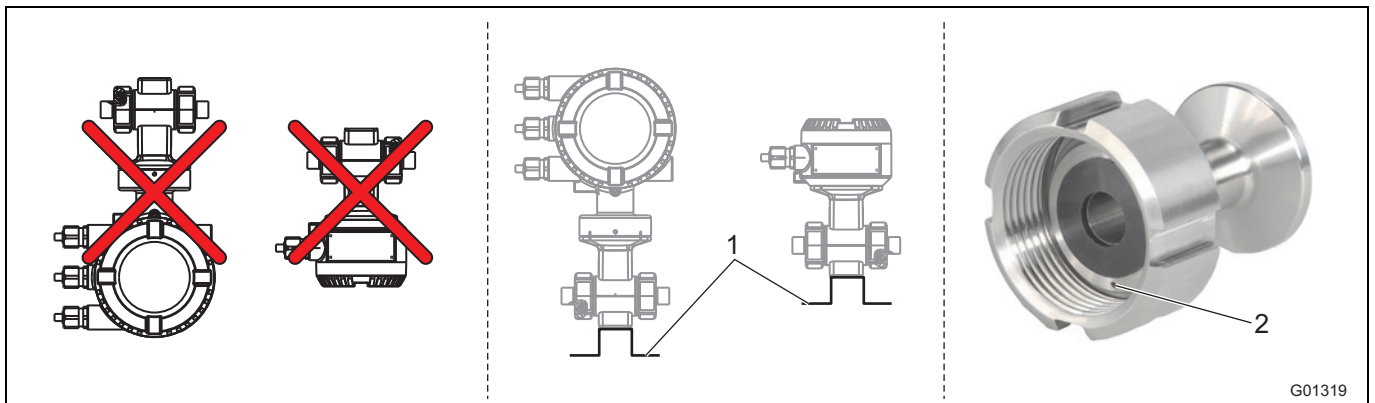

Fig. 12

1 Bracket

2 Leakage hole

Please observe the following points:

- Do not install the device vertically with the terminal box or transmitter housing pointing downward.
- The "angle bracket" option no longer applies.
- Please ensure that the leakage hole of the process connection is located at the deepest point of the installed device.
- Only devices with a transmitter with dual-compartment housing are 3A-compliant.

Mounting

4.4 Installation Requirements

4.4.1 Flow direction

The device measures the flowrate in both directions. Forward flow is the factory setting, as shown in Fig. 13.

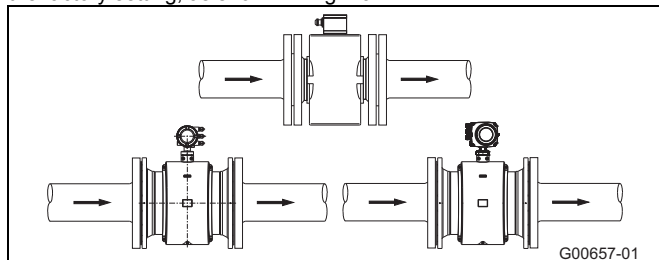

Fig. 13

4.4.2 Electrode axis

Electrode axis (1) should be horizontal if at all possible or no more than 45° from horizontal.

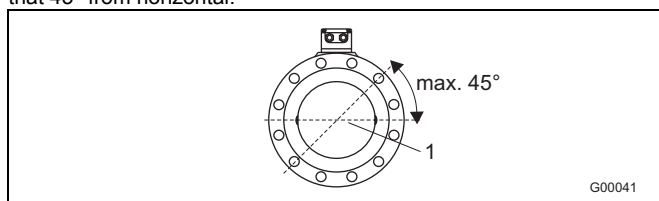

Fig. 14

4.4.3 In- and outlet pipe sections

The metering principle is independent of the flow profile as long as standing eddies do not extend into the metering section, such as may occur after double elbows (1), in the event of tangential inflow, or where half-open gate valves are located upstream of the flowmeter sensor.

In such cases, measures must be put in place to normalize the flow profile.

- Do not install fittings, manifolds, valves, etc., directly in front of the flowmeter sensor (1).
- Butterfly valves must be installed so that the valve plate does not extend into the flowmeter sensor.
- Valves or other turn-off components should be installed in the outlet pipe section (2).

Experience has shown that, in most installations, straight inlet sections 3 x DN long and straight outlet sections 2 x DN long are sufficient (DN = nominal diameter of the sensor Fig. 15).

For test stands, the reference conditions of 10 x DN straight inlet and 5 x DN straight outlet must be provided, in accordance with EN 29104 / ISO 9104.

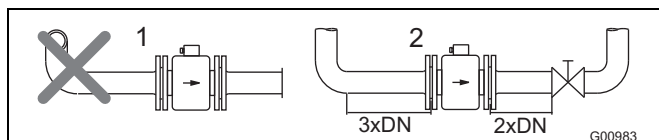

Fig. 15

4.4.4 Vertical connections

Vertical installation for measuring abrasive fluids, preferably with flow in upward direction.

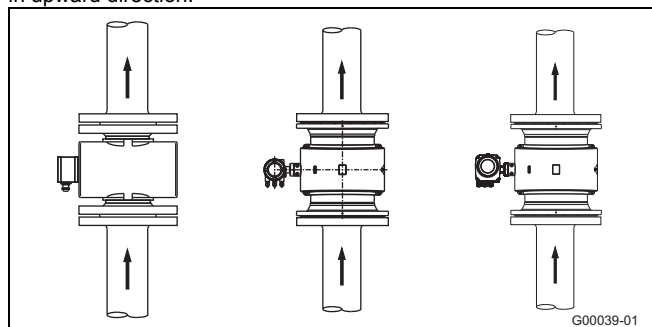

Fig. 16

4.4.5 Horizontal connections

- Meter tube must always be completely full.
- Provide for a slight incline of the connection for degassing.

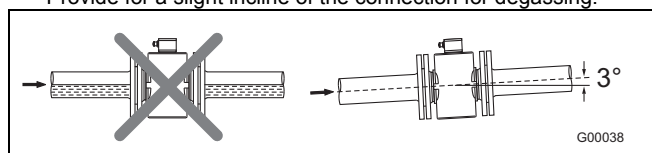

Fig. 17

4.4.6 Free inlet or outlet

- Do not install the flowmeter at the highest point or in the draining-off side of the pipeline, flowmeter runs empty, air bubbles can form (1).
- Provide for a siphon fluid intake for free inlets or outlets so that the pipeline is always full (2).

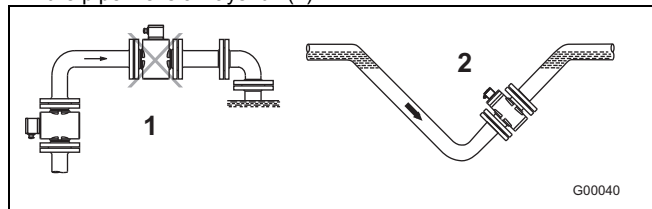

Fig. 18

4.4.7 Strongly contaminated measuring media

For strongly contaminated measuring media, a bypass connection according to the figure is recommended so that operation of the system can continue to run without interruption during the mechanical cleaning.

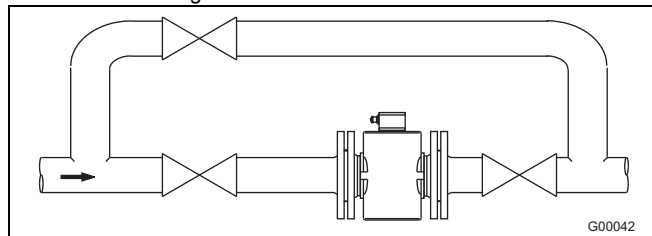

Fig. 19

4.4.8 Installation in the vicinity of pumps

For flowmeter primaries which are to be installed in the vicinity of pumps or other vibration generating equipment, the utilization of mechanical snubbers is advantageous.

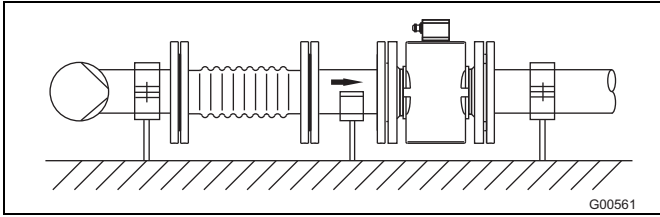

Fig. 20

4.4.9 Installation of the high temperature design

The high temperature design allows for complete thermal insulation of the sensor. The pipeline and sensor must be insulated after installing the unit according to the following illustration.

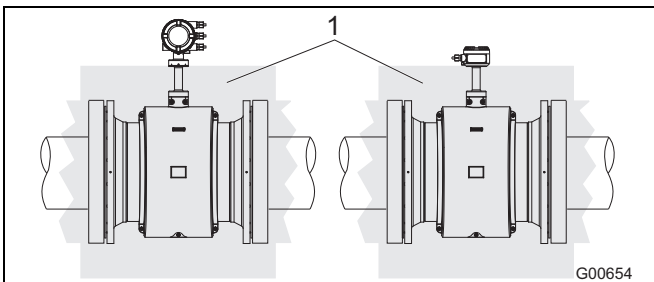

Fig. 21

1 Insulation

4.4.10 Devices with extended diagnostic functions

For devices with extended diagnostic functions different installation conditions may be valid. For further information read and observe chapter 9 "Extended diagnostic functions" on page 138.

4.4.11 Minimum distance

In order to prevent the devices from interfering with each other, a minimum distance of 0.7 m (2.3 ft) must be maintained between the devices.

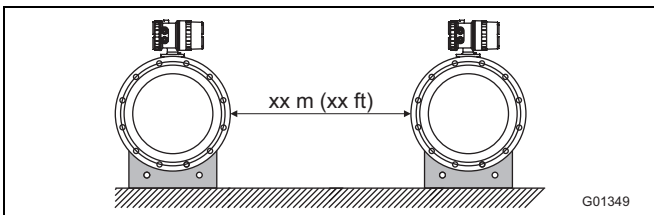

Fig. 22

4.4.12 Installation in pipelines with larger nominal diameters

Determine the resulting pressure loss when using reduction pieces (1):

1. Calculate the diameter ratio d/D .
2. Determine the flow velocity based on the flow range nomograph (Fig. 24).
3. Read the pressure drop on the Y-axis in Fig. 24.

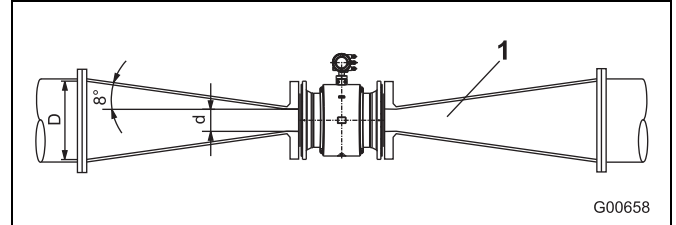

Fig. 23

- 1 Flange transition piece
- d Inside diameter of the flowmeter
- V flow velocity [m/s]
- Δp pressure loss [mbar]
- D Inside diameter of the pipeline

Nomograph for pressure drop calculations

For flange transition piece with $\alpha/2 = 8^\circ$

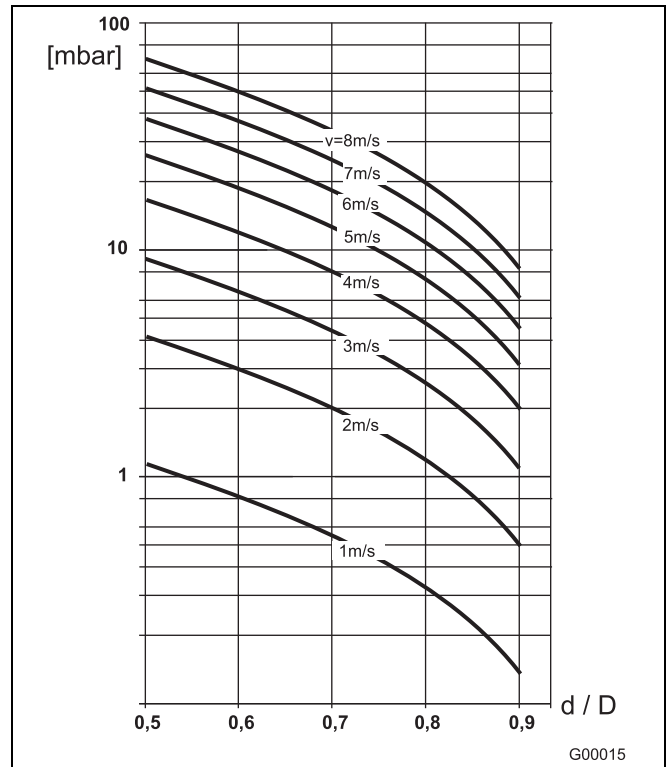

Fig. 24

Mounting

4.5 Rotating the LCD display / Rotating the housing

Depending on the mounting position, the LCD display or transmitter housing can be rotated to enable horizontal readings.

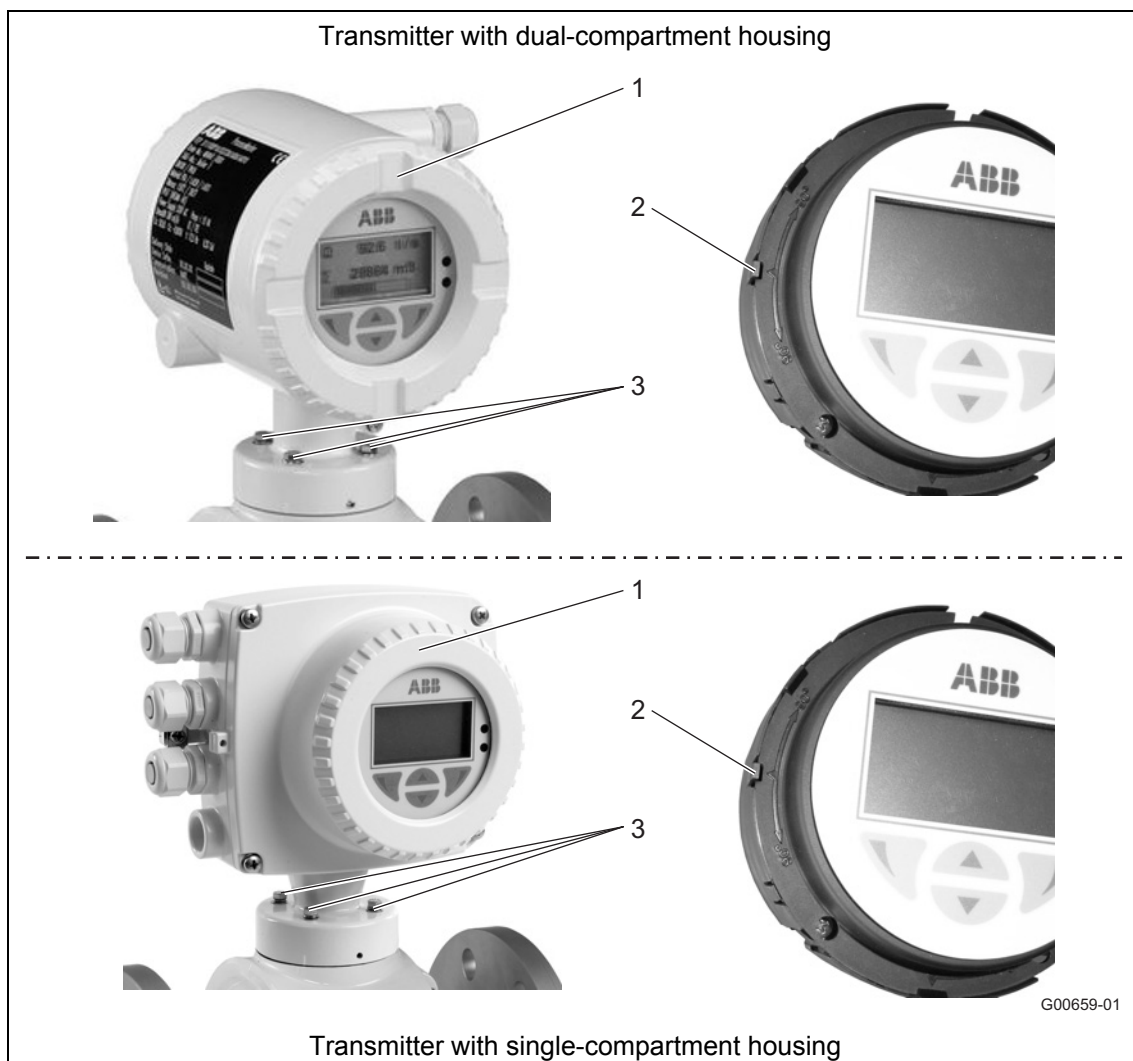

Fig. 25

4.5.1 Rotating the LCD display

**WARNING – Electrical dangers!**

When the housing is open, EMC protection is impaired and there is no longer any protection against accidental contact.

Switch off the power supply before opening the housing.

1. Switch off the power supply.
2. Unscrew housing cover (1).
3. Pull back the anti-rotation lock (2) and turn the LCD display 90° to the left or right until the lock (2) catches again.
4. Screw on housing cover (1) again.

**NOTICE - Potentially adverse effect on housing ingress protection**

If the gasket (o-ring) is seated incorrectly or damaged, this may have an adverse effect on the housing ingress protection.

Before closing the housing cover, check the gasket (o-ring) for any damage and replace if necessary. Check that the gasket is properly seated when closing the housing cover.

4.5.2 Rotating the housing

1. Loosen screws (3) and rotate housing 90° to the left or right.
2. Retighten screws (3).

4.6 Ground

**IMPORTANT (NOTE)**

An additional document with Ex safety instructions is available for measuring systems that are used in explosion hazardous areas. As a result, it is crucial that the specifications and data it lists are also observed.

4.6.1 General information on ground connections

Observe the following items when grounding the device:

- For plastic pipes or pipes with insulating lining, the ground is provided by the grounding plate or grounding electrodes.
- When stray potentials are present, install a grounding plate upstream and downstream of the flowmeter sensor.
- For measurement-related reasons, the potentials in the station ground and in the pipeline should be identical.
- An additional ground on the terminals is not required.

**IMPORTANT (NOTE)**

If the flowmeter sensor is installed in plastic or earthenware pipelines, or in pipelines with an insulating lining, transient current may flow through the grounding electrode in special cases. In the long term, this may destroy the sensor, since the ground electrode will in turn degrade electrochemically. In these special cases, the connection to the ground must be performed using grounding plates. Install a grounding plate upstream and downstream of the device in this case.

4.6.2 Metal pipe with fixed flanges

Use a copper wire (at least 2.5 mm² (14 AWG)) to establish the ground connection between the sensor (1), the pipeline flanges and an appropriate grounding point.

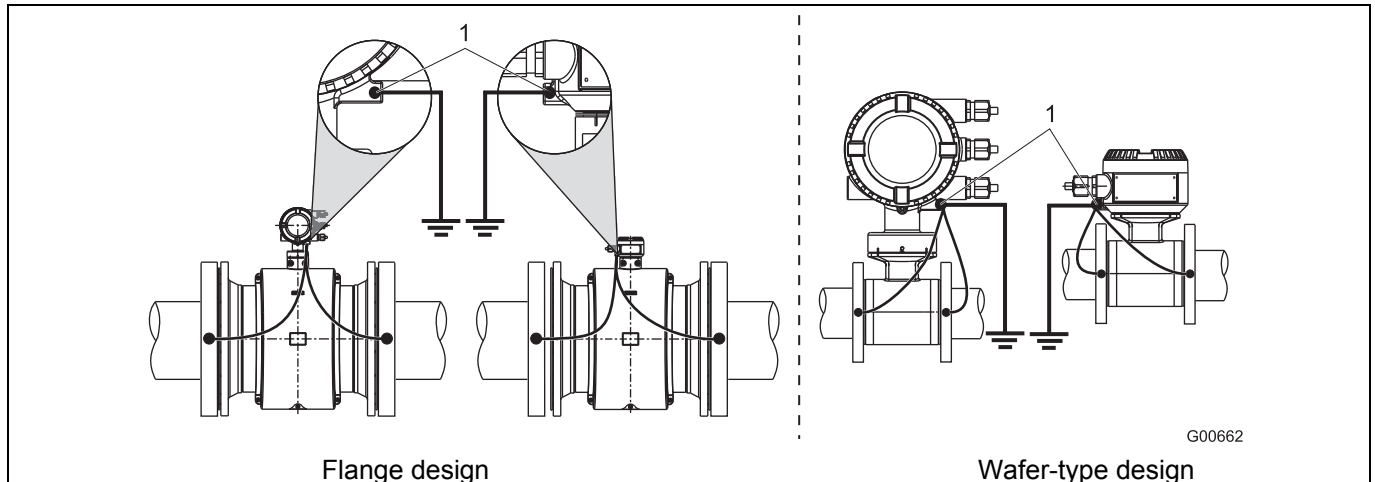

Fig. 26: Metal pipe, without liner (example)

i

IMPORTANT (NOTE)

- Earthing is illustrated using the example of the dual-compartment transmitter housing; in the case of transmitters with single-compartment housing, earthing is to be performed as shown

4.6.3 Metal pipe with loose flanges

1. Solder the threaded nuts M6 (1) to the pipeline and connect the ground as shown in the illustration.
2. Use a copper wire (at least 2.5 mm² (14 AWG)) to establish the ground connection between the sensor (2) and an appropriate grounding point.

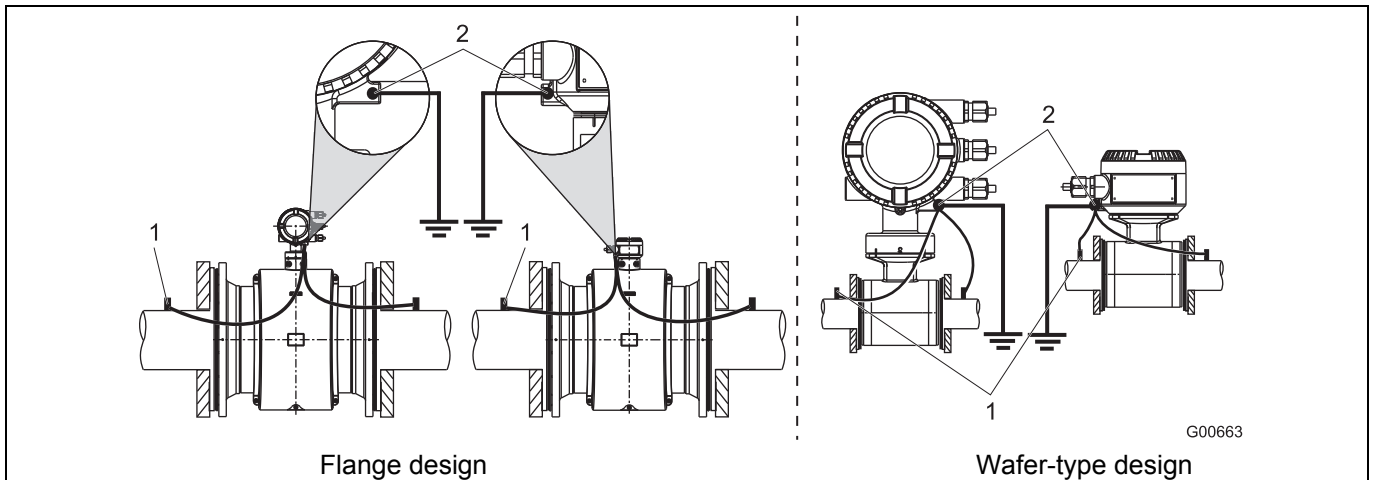

Fig. 27: Metal pipe, without liner (example)



IMPORTANT (NOTE)

- Earthing is illustrated using the example of the dual-compartment transmitter housing; in the case of transmitters with single-compartment housing, earthing is to be performed as shown

4.6.4 Plastic pipes, non-metallic pipes or pipes with insulating liner

For plastic pipes or pipes with insulating lining, the earthing for the measuring medium is provided by the grounding plate as shown in the figure below or via grounding electrodes that must be installed in the device (option). If grounding electrodes are used, the grounding plate is not necessary.

1. Install the flowmeter sensor with grounding plate (3) in the pipeline.
2. Connect the terminal lug (2) for the grounding plate (3) and ground connection (1) on the flowmeter sensor with the grounding strap.
3. Use a copper wire (min. 2.5 mm² (14 AWG)) to link the earthing terminal (1) to a suitable earthing point.

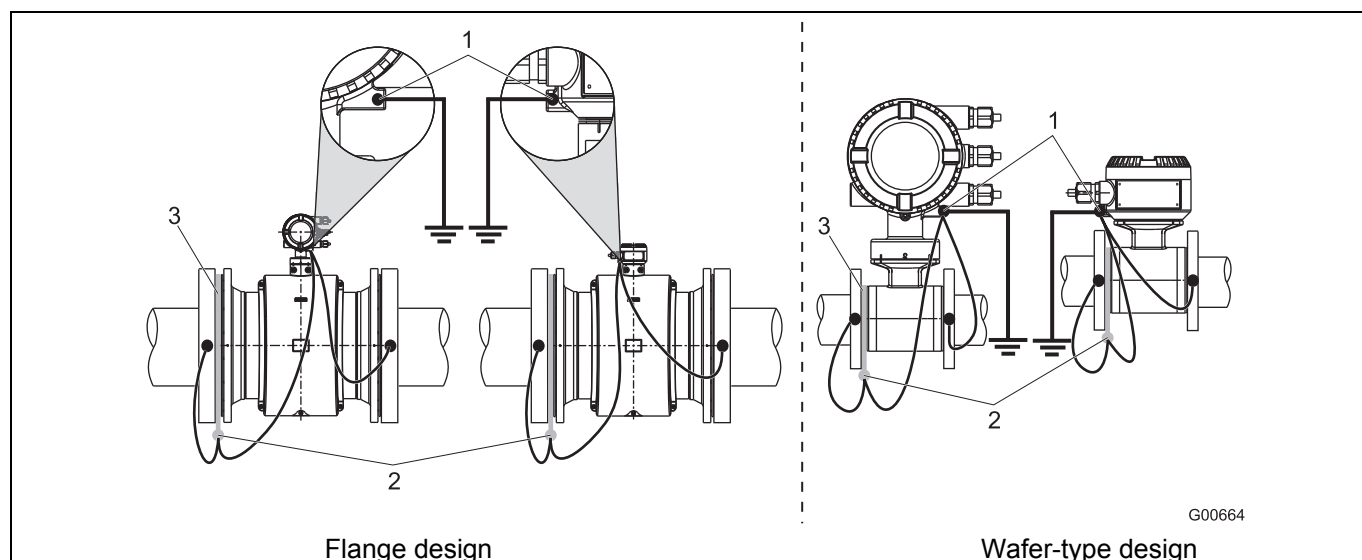

Fig. 28: Plastic pipes, non-metallic pipes or pipes with insulating liner



IMPORTANT (NOTE)

- Earthing is illustrated using the example of the dual-compartment transmitter housing; in the case of transmitters with single-compartment housing, earthing is to be performed as shown

4.6.5 Sensor type HygienicMaster

Ground the stainless steel model as shown in the figure. The measuring fluid is grounded via the adapter (1) and an additional ground is not required.

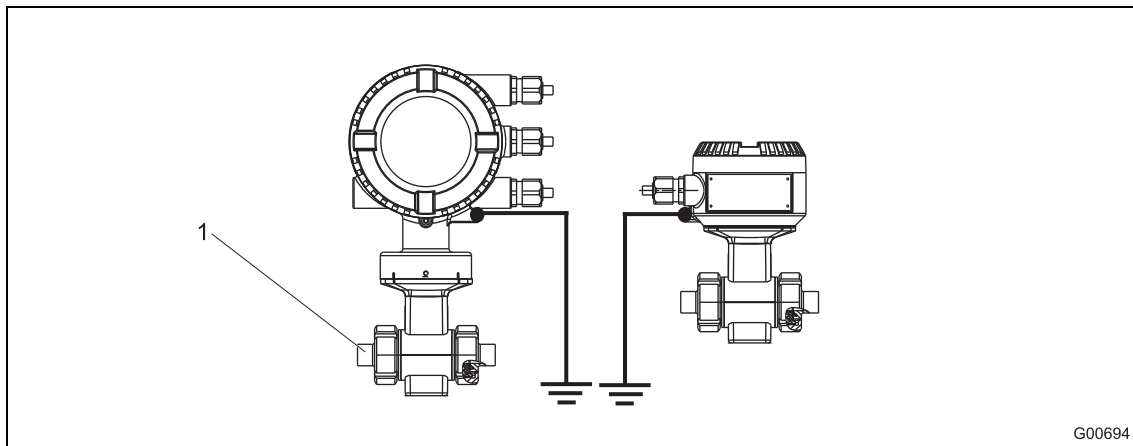

Fig. 29

4.6.6 Ground for devices with protective plates

The protective plates are used to protect the edges of the liner in the measuring tube, e.g., for abrasive fluids. In addition, they function as a grounding plate.

- For plastic or pipes with insulating lining, electrically connect the protective plate in the same manner as a grounding plate.

4.6.7 Ground with conductive PTFE grounding plate

For devices with a meter size between DN 10 ... 250, grounding plates made of conductive PTFE are available. These are installed in a similar way to conventional grounding plates.

4.6.8 Devices with extended diagnostic functions

For devices with extended diagnostic functions different grounding conditions may be valid. For further information read and observe chapter 9 “Extended diagnostic functions”.

4.6.9 Installation and grounding in pipelines with cathodic corrosion protection (CCP)

The installation of electromagnetic flowmeters in systems with cathodic corrosion protection must be made in compliance with the corresponding system conditions. The following factors are especially important:

- a) Pipelines inside electrically conductive or insulating.
- b) Pipelines completely or for the most part with cathodic corrosion protection (CCP) or mixed systems with CCP areas and PE areas.
- When installing an EMF in pipes with insulating inner lining and free from foreign matter, it should be insulated with grounding plates on the upstream and downstream side. The CCP potential is diverted. The grounding plates upstream and downstream of the EMF are connected to functional ground (Fig. 30 / Fig. 31).
- If the occurrence of external stray currents is to be expected in pipelines with internal insulation (e.g. in the case of long pipe sections in the vicinity of power supply units), an uninsulated pipe of approx. 1/4 DN of length should be provided upstream and downstream of the flowmeter sensor in order to deviate these currents away from the measuring system (Fig. 32).

4.6.9.1 Internally insulated pipelines with cathodic corrosion protection potential

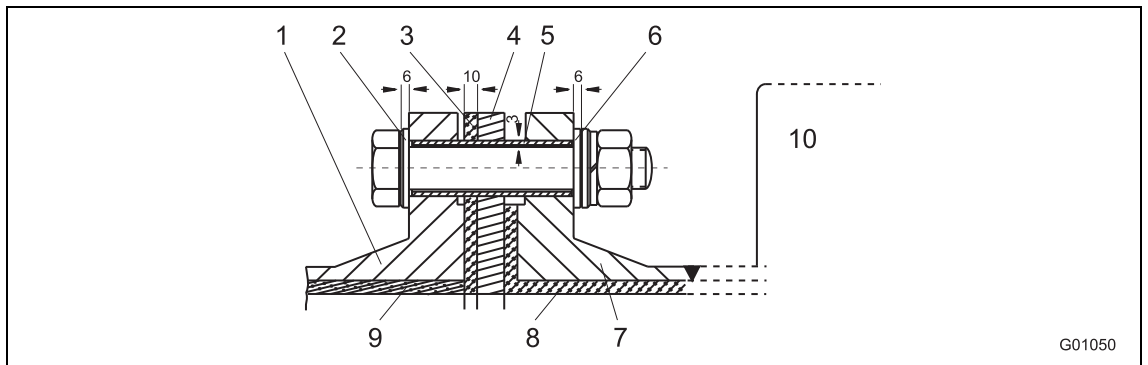

Fig. 30: Bolt screw view

- | | |
|----------------------------|---------------------|
| 1 Pipe flange | 6 Insulating plate |
| 2 Insulating plate | 7 Flange |
| 3 Gasket / insulating ring | 8 Lining |
| 4 Grounding plate | 9 Insulation |
| 5 Insulating pipe | 10 Flowmeter sensor |

Install grounding plates on each side of the flowmeter sensor. Insulate the grounding plates from the pipe flanges and connect them to the flowmeter sensor and to functional ground. Insulate the screw bolts for the flange connections when mounting. The insulation plates and the insulation pipe are not included in the delivery. They must be provided onsite by the customer.

The CCP potential must be diverted through a connecting line "A" away from the insulated flowmeter sensor.

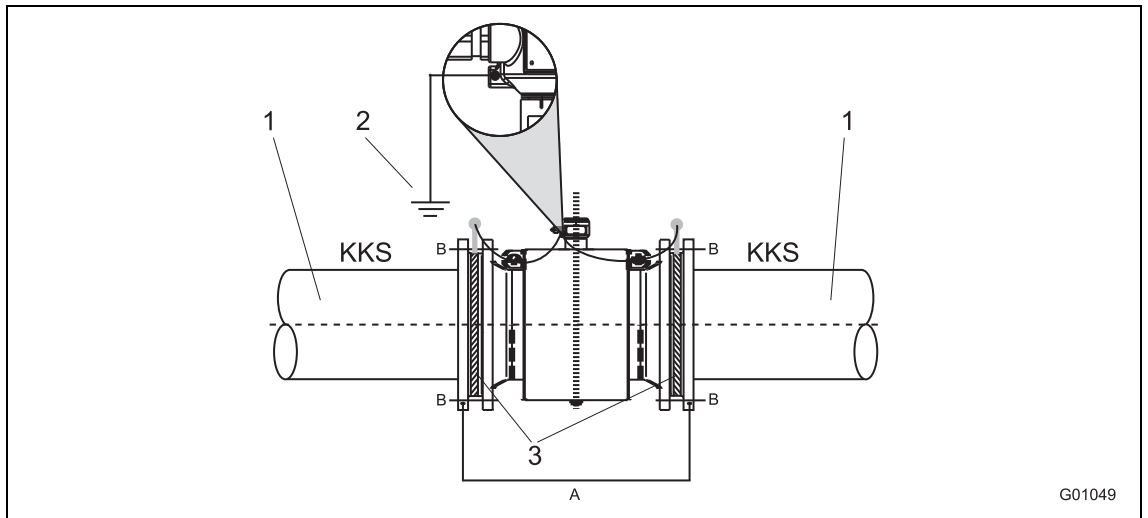

Fig. 31: Flowmeter sensor with grounding plate and functional ground

- 1 Insulated pipe
- 2 Functional ground
- 3 Grounding plate
- A Connecting line for CCP potential $\geq 4 \text{ mm}^2 \text{ Cu}$, not included in the delivery, to be provided onsite
- B Insulated screw bolts without grounding plates

4.6.9.2 Mixed system pipeline with CCP and functional ground potentials

This mixed system has an insulated pipeline with CCP potential and an uninsulated bar metal pipe ($L = 1/4 \times \text{flowmeter sensor size}$) with functional ground potential upstream and downstream of the flowmeter sensor.

The Fig. 32 shows the preferred installation for cathodic corrosion protection systems.

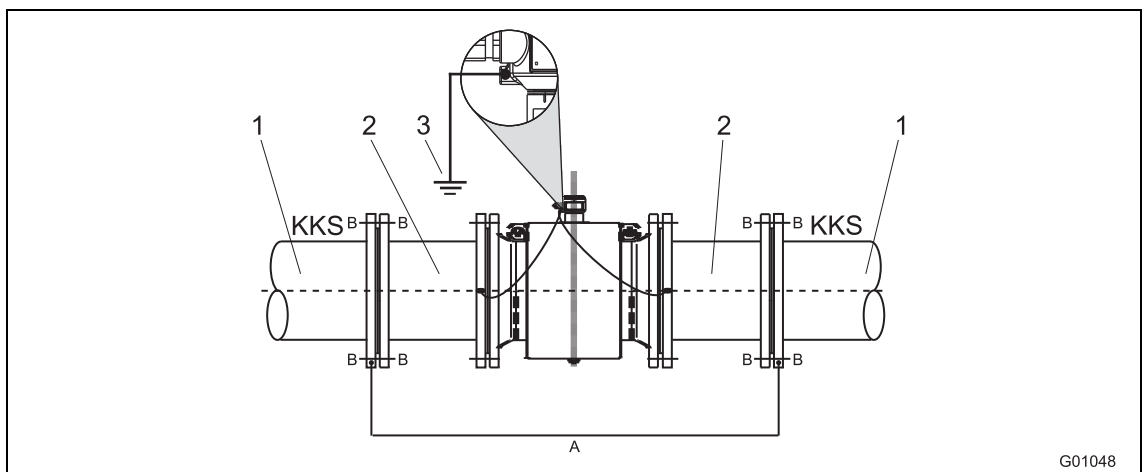

Fig. 32: Flowmeter sensor with functional ground

- 1 Insulated pipe
- 2 Bare metal pipe
- 3 Functional ground
- A Connecting line for CCP potential $\geq 4 \text{ mm}^2 \text{ Cu}$, not included in the delivery, to be provided onsite
- B Insulated screw bolts without grounding plates

5 Electrical connections

5.1 Routing the signal and magnet coil cable

Observe the following points when routing cables:

- A magnet coil cable (red and brown) is run parallel to the signal lines (violet and blue). As a result, only one cable is required between the flowmeter sensor and the transmitter. Do not run the cable over junction boxes or terminal strips.
- The signal cable carries a voltage signal of only a few millivolts and must, therefore, be routed over the shortest possible distance. The max. allowable signal cable length is 50 m (164 ft) without pre-amplifier and 200 m (656 ft) with pre-amplifier.
- Avoid routing the cable in the vicinity of electrical equipment or switching elements that can create stray fields, switching pulses, and induction. If this is not possible, run the signal / magnet coil cable through a metal pipe and connect this to the station ground.
- All leads must be shielded and connected to the station ground potential.
- To shield against magnetic interspersion, the cable contains outer shielding. This is attached to the SE clamp.
- The supplied stranded steel wire is also connected to the SE clamp.
- Do not damage the sheathing of the cable during installation.
- Make sure during installation that the cable is provided with a water trap (1). For vertical installation, align the cable glands pointing downward.

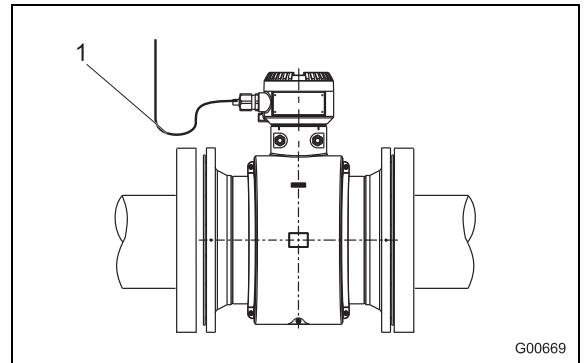

Fig. 33

5.2 Preparing the signal and magnet coil cable in the case of transmitters with dual-compartment housing

5.2.1 Cable with part number D173D027U01

Prepare both cable ends as shown.



IMPORTANT (NOTE)

Use wire end sleeves.

- Wire end sleeves 0.75 mm² (AWG 19), for shielding (1S, 2S)
 - Wire end sleeves 0.5 mm² (AWG 20), for all other wires
- The shields may not touch (signal short circuit).

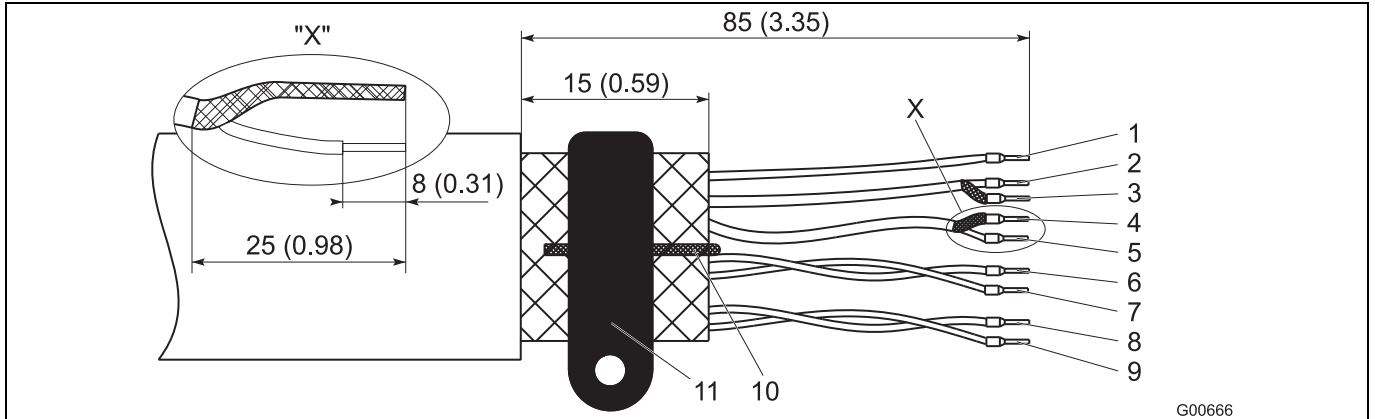

Fig. 34: Flowmeter sensor side, dimensions in mm (inch)

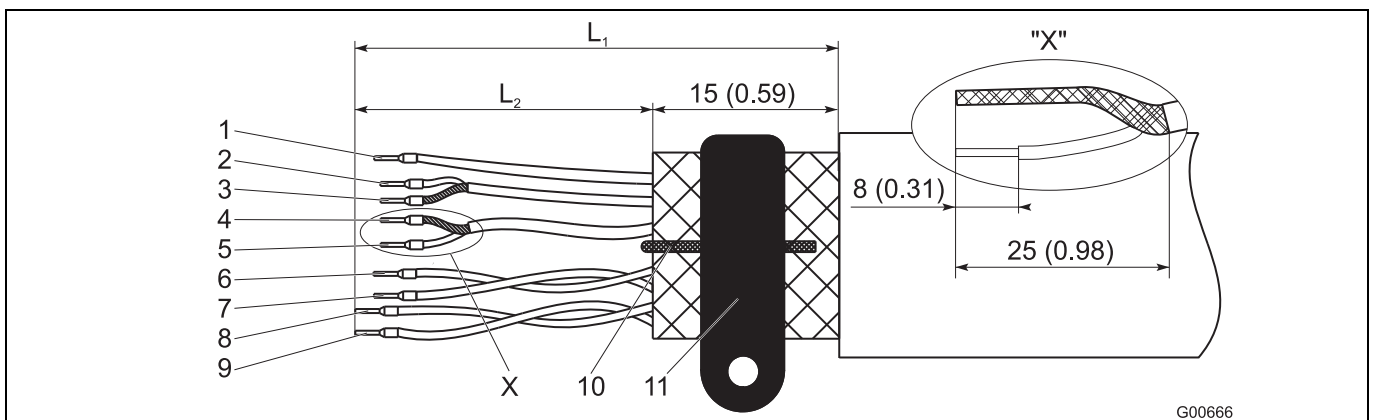

Fig. 35: Transmitter side, dimensions in mm (inch)

L₁ maximum stripped length = 105 (4.10)

1 Measurement potential 3, green	L2 = 70 (2.76)	7 Data line, D1, orange	L2 = 70 (2.76)
2 Signal line E1, violet	L2 = 60 (2.36)	8 Magnet coil, M2, red	L2 = 90 (3.54)
3 Shield 1S	L2 = 60 (2.36)	9 Magnet coil, M1, brown	L2 = 90 (3.54)
4 Shield 2S	L2 = 60 (2.36)	10 Ground wire, steel	
5 Signal line, E2, blue	L2 = 60 (2.36)	11 SE clamp	
6 Data line, D2, yellow	L2 = 70 (2.76)		

5.2.2 Cable with part number D173D031U01

Prepare both cable ends as shown.



IMPORTANT (NOTE)

Use wire end sleeves.

- Wire end sleeves 0.75 mm² (AWG 19), for shielding (1S, 2S)
- Wire end sleeves 0.5 mm² (AWG 20), for all other wires

The shields may not touch (signal short circuit).

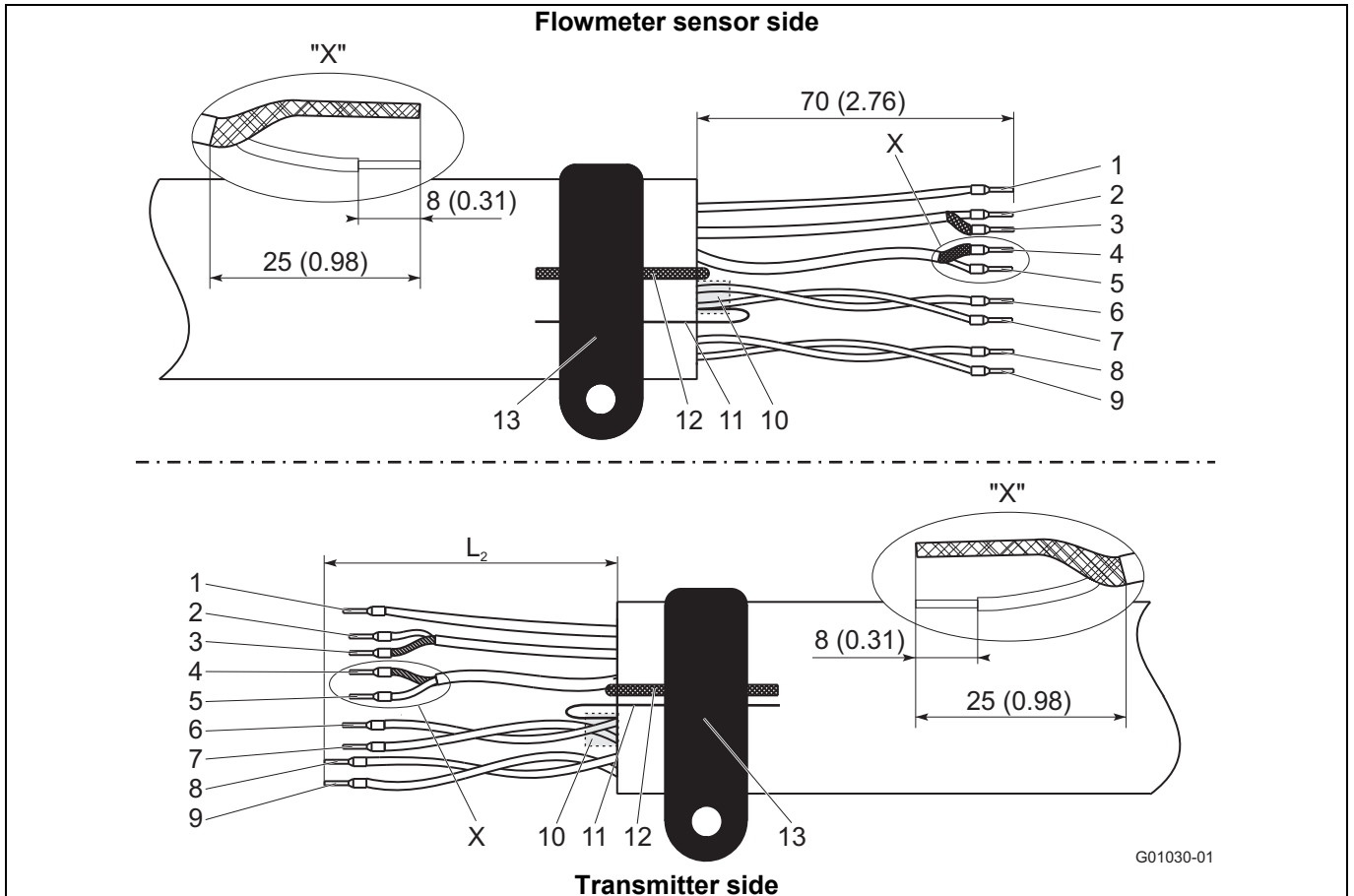

Fig. 36: Flowmeter sensor side, dimensions in mm (inch)

1 Measurement potential 3, green	L2 = 70 (2.76)	8 Magnet coil, M2, red	L2 = 90 (3.54)
2 Signal line E1, violet	L2 = 60 (2.36)	9 Magnet coil, M1, brown	L2 = 90 (3.54)
3 Shield 1S	L2 = 60 (2.36)	10 Foil shield (D1, D2)	
4 Shield 2S	L2 = 60 (2.36)	11 Foil shield continuity wire (D1, D2)	
5 Signal line, E2, blue	L2 = 60 (2.36)	12 Ground wire, steel	
6 Data line, D2, yellow	L2 = 70 (2.76)	13 SE clamp	
7 Data line, D1, orange	L2 = 70 (2.76)		

5.3 Preparing the signal and magnet coil cable in the case of transmitters with single-compartment housing

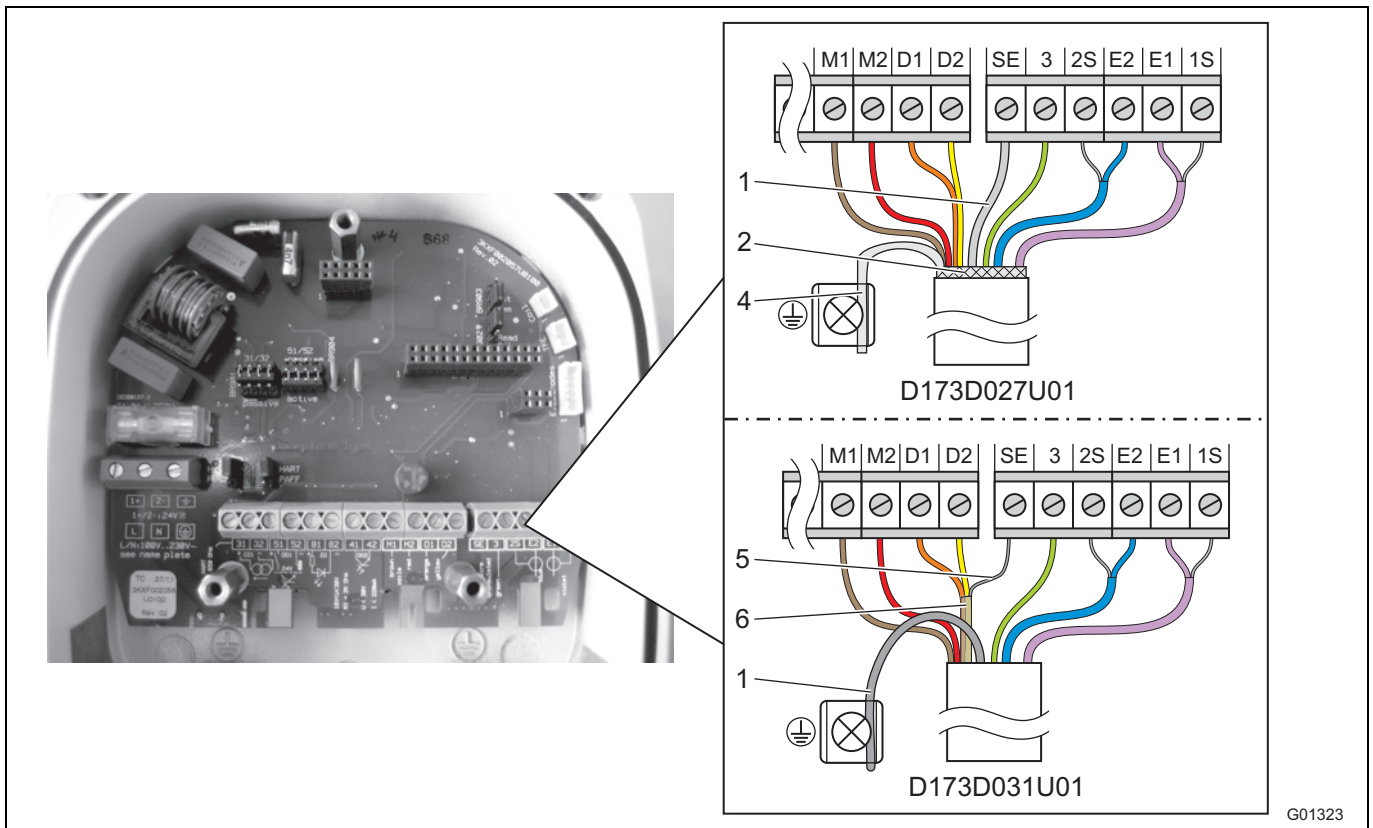

Fig. 37: Transmitter side, dimensions in mm (inch)

- 1 Ground wire
- 2 Wire mesh shield (D173D027U01 only)
- 4 Twisted wire mesh shield (D173D027U01 only)
- 5 Foil shield continuity wire D1, D2 (D173D031U01 only)
- 6 Foil shield D1, D2 (D173D031U01 only)

Terminal	Description, wire color	Length in mm (inch)
M1	Magnet coil, brown	70 (2.76)
M2	Magnet coil, red	70 (2.76)
D1	Data line, orange	70 (2.76)
D2	Data line, yellow	70 (2.76)
SE	Shield	-
3	Measurement potential, green	70 (2.76)
2S	Shield for E2	60 (2.36)
E2	Signal line, blue	60 (2.36)
E1	Signal line, violet	60 (2.36)
1S	Shield for E1	60 (2.36)



IMPORTANT (NOTE)

- Use wire end sleeves.
 - Wire end sleeves 0.75 mm² (AWG 19), for shielding (1S, 2S)
 - Wire end sleeves 0.5 mm² (AWG 20), for all other wires
- The shields may not touch (signal short circuit).

Prepare the cable end on the transmitter side as shown in Fig. 37.

5.3.1 Cable with part number D173D027U01

- Twist the wire mesh shield of the cable and connect to the ground terminal.
- Connect the ground wire of the cable to the SE clamp of the terminal strip.
- Connect all other wires as shown in Fig. 37.

5.3.2 Cable with part number D173D031U01

- Connect the cable ground wire together with the foil shield continuity wire from D1, D2 to the SE clamp of the terminal strip.
- When using the flowmeter sensor in systems with cathodic corrosion protection (CCP), connect the cable ground wire together with the foil shield continuity wire from D1, D2 to the SE clamp of the terminal strip.
- Connect all other wires as shown in Fig. 37.

5.4 Connecting the flowmeter sensor

5.4.1 Metal terminal box for ProcessMaster and HygienicMaster

Connections can only be made with the power supply switched off.

The device must be earthed according to instructions. The sensor is connected to the transmitter via the signal / magnetic coil cable (part no. D173D027U01 or D173D031U01).

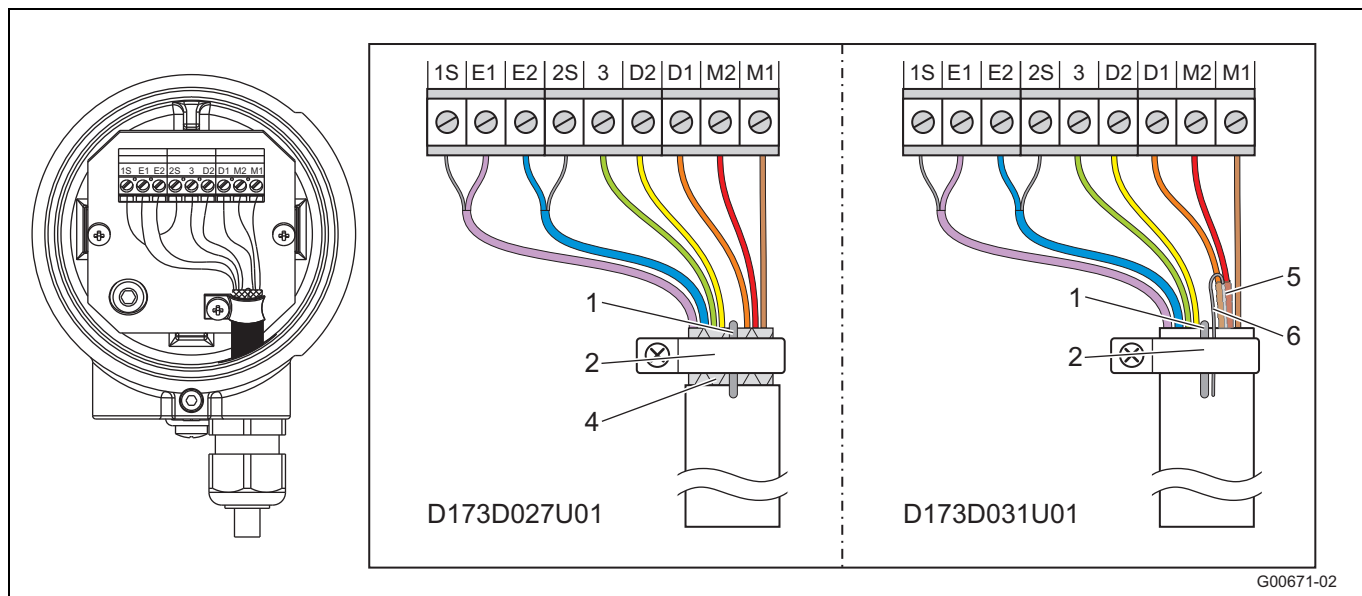

Fig. 38

- 1 Earth wire.
- 2 Earth clamp.
- 4 Braided shield (D173D027U01 only).
- 5 Foil shield D1, D2 (D173D031U01 only).
- 6 Continuity wire of the foil shield (D1, D2) (D173D031U01 only).

Terminal	Description, wire color
M1	Magnetic coil, brown
M2	Magnetic coil, red
D1	Data line, orange
D2	Data line, yellow
PE	Shielding
3	Measurement potential, green
2S	Shield for E2
E2	Signal line, blue
E1	Signal line, violet
1S	Shield for E1



IMPORTANT (NOTE)

The cable with the part number D173D027U01 can be used for all device designs.
 The cable with the part number D173D031U01 can be used for all device designs.

- Sensor without explosion protection from nominal diameter DN 15 (models FEP321, FEH321, FEP521, FEH521)
- Sensor for use in Zone 2, Div. 2 from nominal diameter DN 15 (models FEP325, FEH325, FEP525, FEH525)



IMPORTANT (NOTE)

Use wire end sleeves.

- Wire end ferrules 0.75 mm² (19 AWG), for shielding (1S, 2S)
- Wire end ferrules 0.5 mm² (20 AWG), for all other wires

The shielding may not touch (signal short circuit).

Cable with part number D173D027U01

- Uncover the braided shield of the cable and connect to the earth clamp together with the earth wire
- Connect all other wires as shown in Fig. 38

Cable with part number D173D031U01

- Connect the earth wire of the cable together with the continuity wire of the foil shield from D1, D2 to the earth clamp
- Connect all other wires as shown in Fig. 38

5.4.2 Connection via cable conduit



NOTICE - Condensate formation in terminal box

If the flowmeter sensor is permanently connected to cable conduits, there is a possibility that moisture may get into the terminal box as a result of condensate formation in the cable conduit.

Ensure that the cable entry points on the terminal box are sealed.

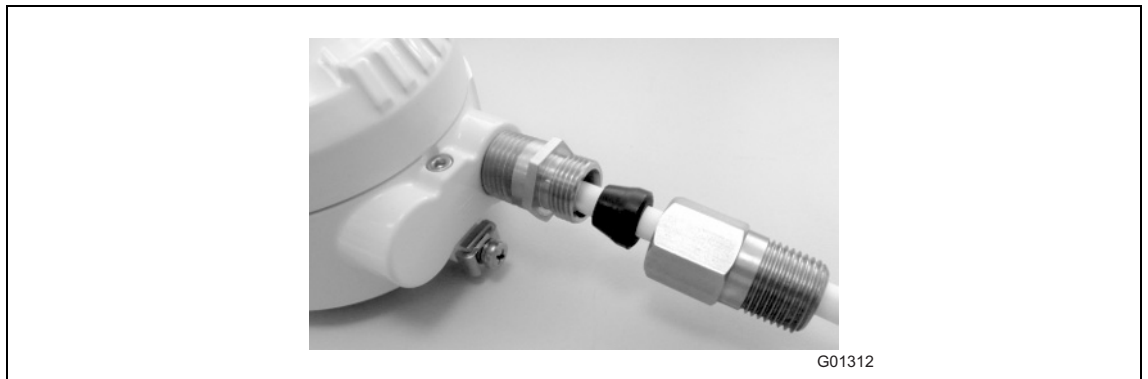

Fig. 39: Installation set for cable conduit

An installation set for sealing the cable conduit is available via order number 3KXF081300L0001.

5.4.3 IP rating IP 68

For sensors with IP rating IP 68, the maximum flooding height is 5 m (16.4 ft). The supplied cable (part no. D173D027U01 or D173D031U01) fulfills all submersion requirements.

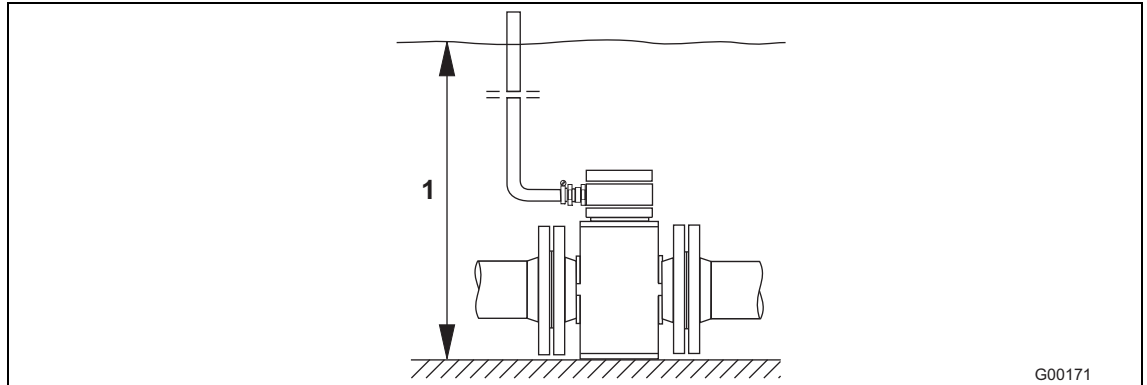

Fig. 40

- 1 Max. flooding height 5 m (16.4 ft)

The sensor is type-tested in accordance with EN 60529. Test conditions: 14 days at a flooding height of 5 m (16.4 ft).

5.4.3.1 Connection

1. Use the supplied cable to connect the sensor and the transmitter.
2. Connect the cable in the terminal box of the sensor.
3. Route the cable from the terminal box to above the maximum flooding height of 5 m (16.4 ft).
4. Tighten the cable gland.
5. Carefully seal the terminal box. Make sure the gasket for the cover is seated properly.



NOTICE – potential adverse effect on IP rating IP 68!

The IP rating IP 68 of the sensor may be adversely affected as a result of damage to the signal cable.

The sheathing of the signal cable must not be damaged. Otherwise, the IP rating IP 68 for the sensor cannot be ensured.



IMPORTANT (NOTE)

As an option, the sensor can be ordered with the signal cable already connected to the sensor and the terminal box already potted.

5.4.3.2 Potting the terminal box

On sensors without explosion protection or explosion protection Zone 2, Div. 2, the terminal box can be subsequently potted.

If the terminal box is to be potted subsequently on-site, a special two-component potting compound can be ordered separately (order no. D141B038U01). Potting is only possible if the sensor is installed horizontally. Observe the following instructions during work activity:



WARNING - General dangers!

The two-component potting compound is toxic – observe all relevant safety measures!

Hazard warnings: R20, R36 / 37 / 38, R42 / 43

Harmful by inhalation. Avoid direct skin contact. Irritating to eyes.

Safety advice: P4, S23-A, S24 / 25, S26, S37, S38

Wear suitable protective gloves and ensure sufficient ventilation.

Follow the instructions that are provided by the manufacturer prior to starting any preparations.

Preparation

- Complete the installation before potting in order to avoid moisture penetration. Before starting, check all the connections for correct fitting and stability
- Do not overfill the terminal box. Keep the potting compound away from the O-ring and the gasket / groove (see fig. Fig. 41)
- Prevent the two-component potting compound from penetrating the cable conduit if an NPT 1/2" installation is used

Procedure

1. Cut open the protective enclosure of the two-component potting compound (see packing).
2. Remove the connection clamp of the potting compound.
3. Knead both components thoroughly until a good mix is reached.
4. Cut open the bag at a corner. Perform work activity within 30 minutes.
5. Carefully fill the terminal box with the two-component potting compound until the connection cable is covered.
6. Wait a few hours before closing the cover in order to allow the compound to dry, and to release any possible gas.
7. Ensure that the packaging material and the drying bag are disposed of in an environmentally sound manner.

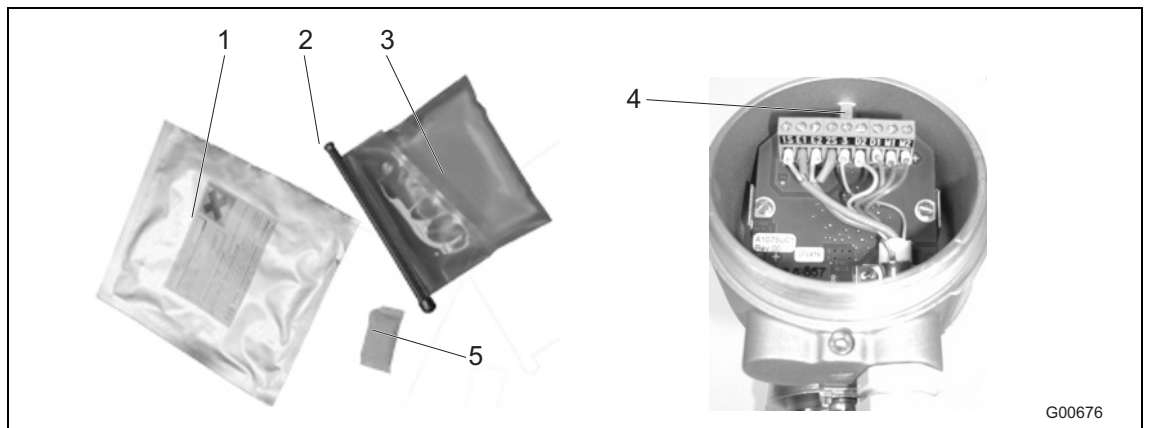

Fig. 41

- | | |
|----------------------------------|----------------------|
| 1 Packing bag | 4 Max. filling level |
| 2 Connection clamp | 5 Drying bag |
| 3 Two-component potting compound | |

5.5 Connecting the transmitter



IMPORTANT (NOTE)

An additional document with Ex safety instructions is available for measuring systems that are used in explosion hazardous areas. As a result, it is crucial that the specifications and data it lists are also observed.

5.5.1 Connecting the power supply

The line voltage and power consumption are indicated on the name plate for the transmitter.

A circuit breaker with a maximum rated current of 16 A must be installed in the power supply line of the transmitter.

The wire cross-sectional area of the power supply cable and the circuit breaker used must comply with VDE 0100 and must be dimensioned in accordance with the current consumption of the flowmeter measuring system. The cables must comply with IEC 227 and/or IEC 245.

The circuit breaker should be located near the transmitter and marked as being associated with the device.

The power supply is connected to terminal L (phase), N (neutral), or 1+, 2-, and PE, as stated on the name plate.

Connect the transmitter and sensor to functional earth.



IMPORTANT (NOTE)

- Observe the power supply limit values in accordance with the information on the name plate and from chapter „Power supply“ on page 163
- Observe the voltage drop for large cable lengths and small conductor cross-sections. The voltage at the terminals of the device may not fall below the minimum value required in accordance with the information on the name plate and from chapter „Power supply“ on page 163,
- Complete the electrical connection in accordance with the connection diagram

Electrical connections

5.5.2 Transmitter with dual-compartment housing

The terminals for the power supply can be found under the terminal cover (1).

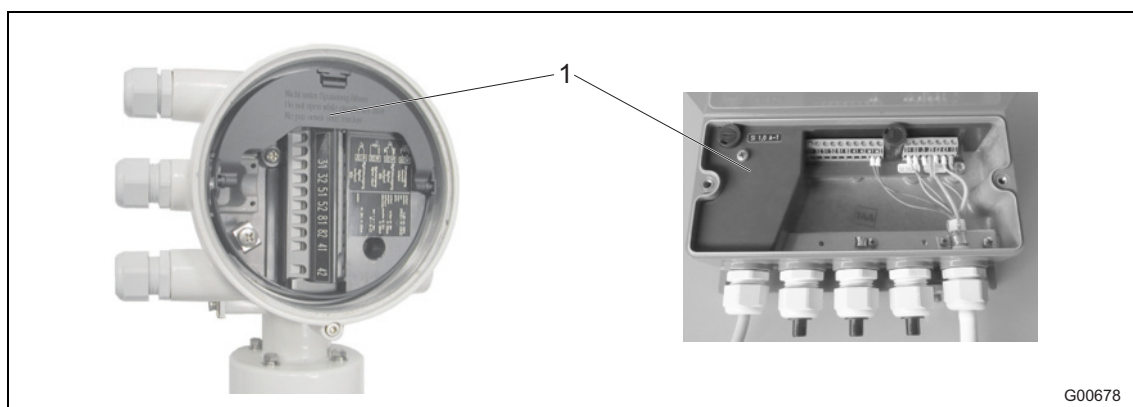

Fig. 42
1 Terminal cover

5.5.3 Transmitter with single-compartment housing

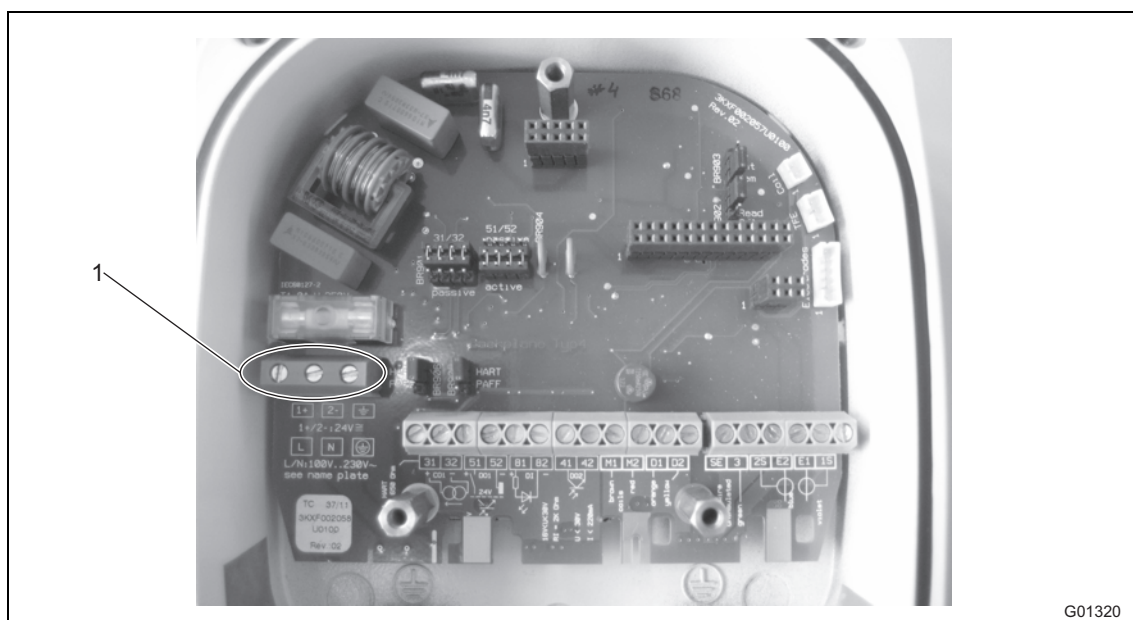

Fig. 43
1 Terminals (power supply)

5.5.4 Connecting the signal and magnet coil cables

The outer shielding of the signal and magnet coil cable is attached to the busbar via the clip (4) (from the accessory bag in the connection area) (dual-compartment transmitter housing only).

In the case of the single-compartment transmitter housing, the outer shielding of the signal and magnet coil cable is connected to the corresponding terminal for the signal and magnet coil cable.

The shielding for the signal wires functions as a driven shield to transmit the measurement signal.

The cable is attached to the flowmeter sensor and transmitter according to the connection diagram.

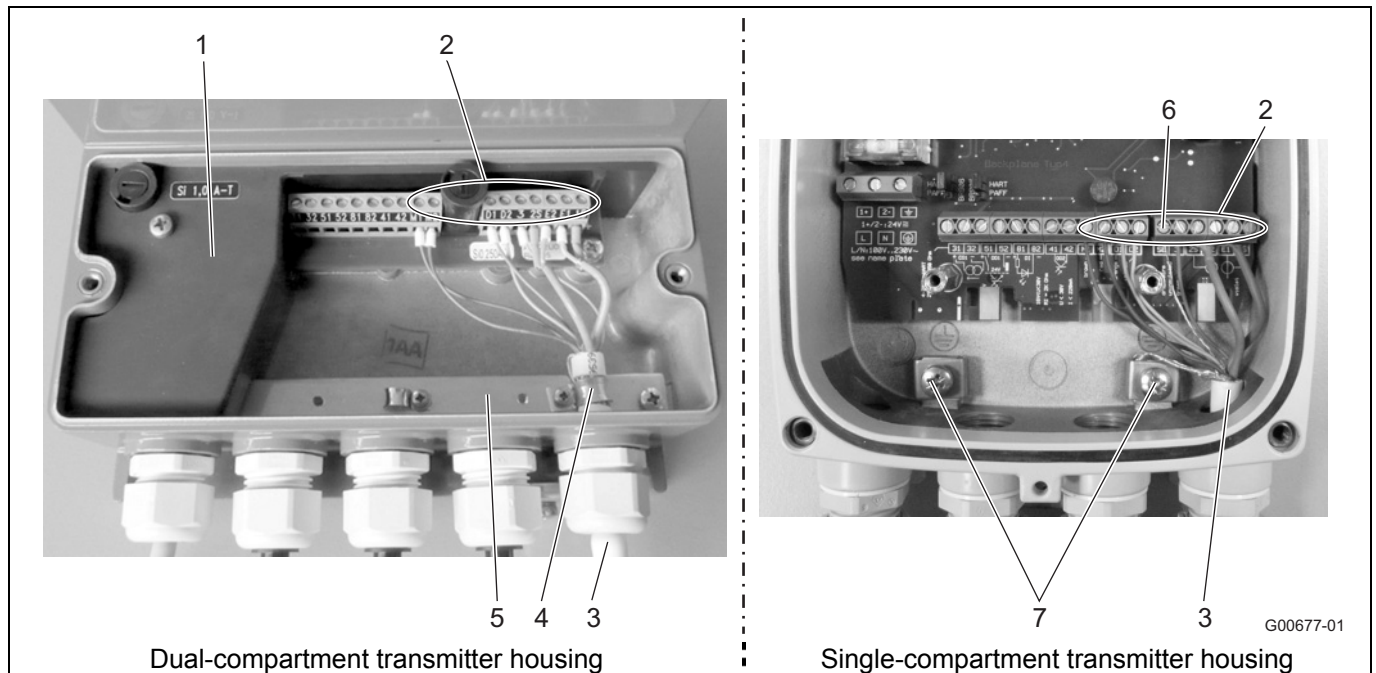

Fig. 44

- 1 Terminal cover
- 2 Terminals for signal and magnet coil cable
- 3 Signal and magnet coil cable
- 4 Clip
- 5 Busbar (SE)
- 6 SE terminal for signal and magnet coil cable shield
- 7 Terminals for cable shields



IMPORTANT (NOTE)

The power supply for the optional pre-amplifier is provided via terminals 1S and 2S. The transmitter automatically detects the sensor and switches to the required supply voltage on terminals 1S and 2S.

Electrical connections

5.6 Terminal connection diagrams

5.6.1 HART, PROFIBUS PA and FOUNDATION fieldbus protocol

i

IMPORTANT (NOTE)

An additional document with Ex safety instructions is available for measuring systems that are used in explosion hazardous areas. As a result, it is crucial that the specifications and data it lists are also observed.

i

Important (Note)

For detailed information about earthing the transmitter and the sensor, please refer to chapter 4.6 "Ground" on page 35!

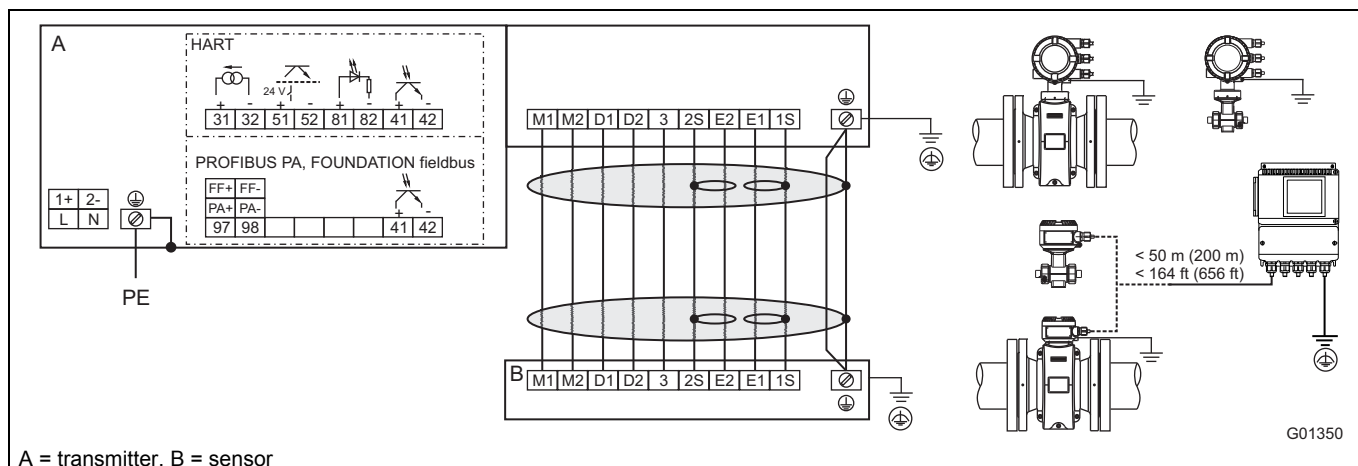

Fig. 45

Power supply connections

AC power supply	
Terminal	Function / Notes
L	Live / Phase
N	Neutral
PE / ⊕	Protective earth (PE)

DC power supply	
Terminal	Function / Notes
1+	+
2-	-
PE / ⊕	Protective earth (PE)

Sensor cable terminal connections

Only on remote mount design.

Terminal	Function / Notes	Wire color
M1	Magnet coil	Brown
M2	Magnet coil	Red
D1	Data line	Orange
D2	Data line	Yellow
⊕ / SE	Shield	-
E1	Signal line	Violet
1S	Schield for E1	-
E2	Signal line	Blue
2S	Schield for E2	-
3	Measurement potential	Green

Output connections

Terminal	Function / Notes
31 / 32	Current / HART output The current output is available in "active" or "passive" mode.
97 / 98	Digital communication PROFIBUS PA (PA+ / PA-) or FOUNDATION fieldbus (FF+ / FF-) in acc. with IEC 61158-2.
51 / 52	Digital output DO1 active / passive Function can be configured locally as „Pulse Output" or „Digital Output". Factory setting is „Pulse Output".
81 / 82	Digital input / contact input Function can be configured locally as „External output switch-off", „external totalizer reset", „external totalizer stop" or „other".
41 / 42	Digital output DO2 passive Function can be configured locally as „Pulse Output" or „Digital Output". Factory setting is „Digital Output", flow direction signaling.
⊕	Functional ground

5.7 Electrical data

5.7.1 Current / HART output

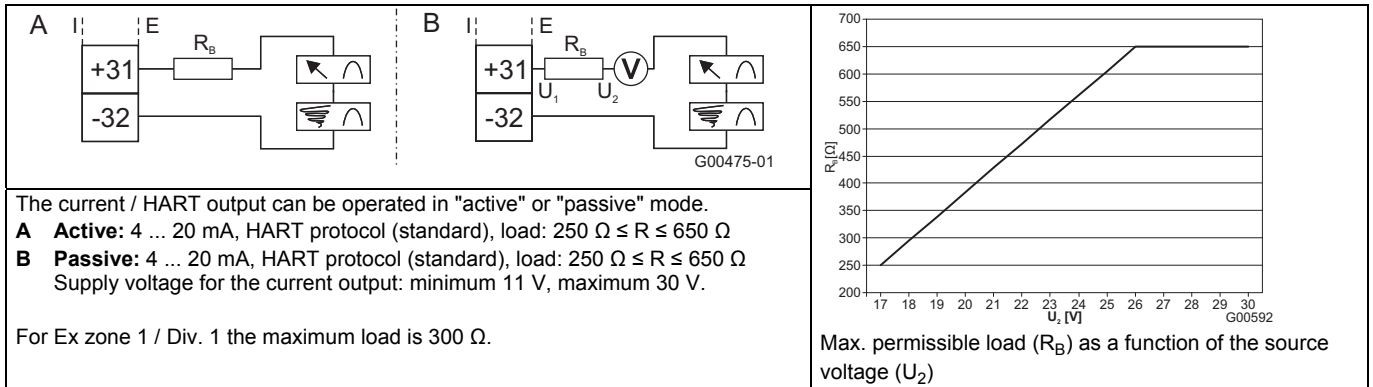

Fig. 46: (I = internal, E = external)

5.7.2 Digital output DO1

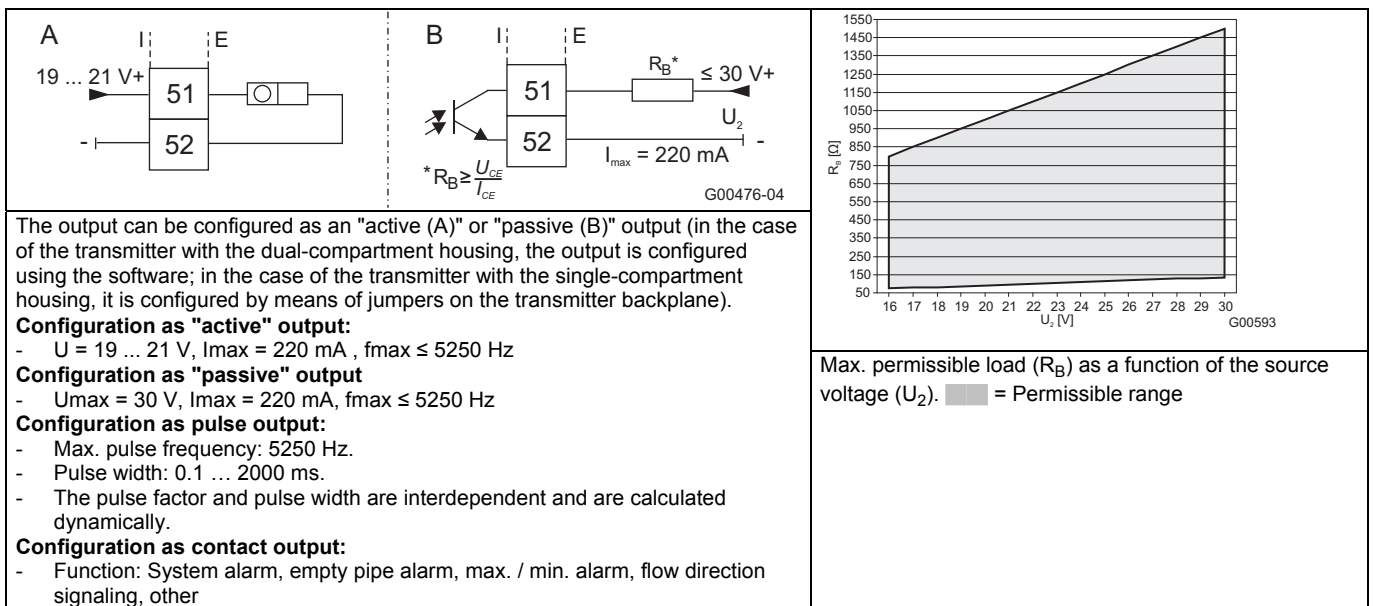

Fig. 47: (I = internal, E = external)

5.7.3 Digital output DO2

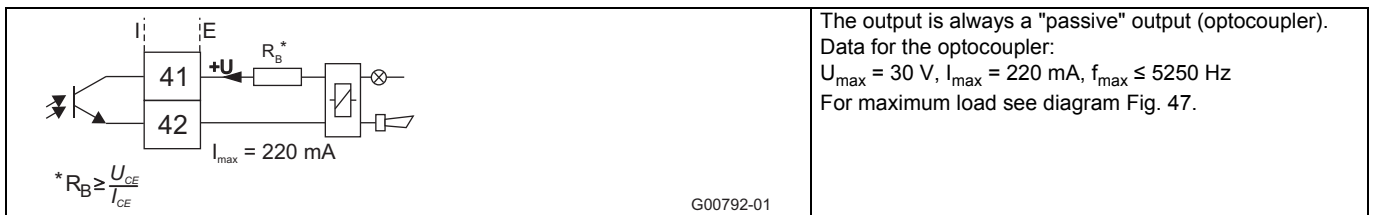

Fig. 48: (I = internal, E = external)

5.7.4 Digital input DI

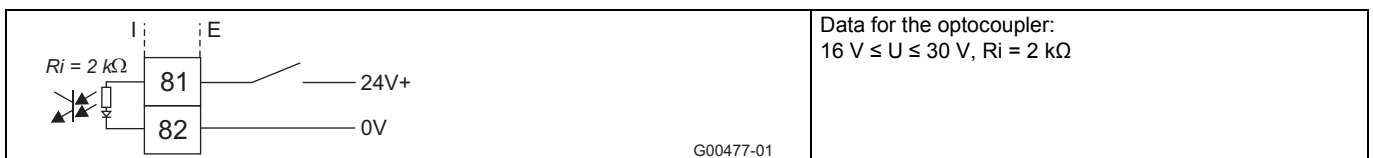

Fig. 49: (I = internal, E = external)

Electrical connections

5.7.5 Digital communication

 <p>PROFIBUS PA (PA+ / PA-) $U = 9 \dots 32 \text{ V}$, $I = 10 \text{ mA}$ (normal operation), $I = 13 \text{ mA}$ (in the event of an error / FDE) Bus connection with integrated protection against polarity reversal. The bus address can be set via the DIP switches in the device (with dual-compartment transmitter housing only), the transmitter display or the fieldbus. The resistance R and condenser C form the bus termination. They must be installed when the device is connected to the end of the entire bus cable. $R = 100 \Omega$; $C = 1 \mu\text{F}$</p>	 <p>FOUNDATION fieldbus (FF+ / FF-) $U = 9 \dots 32 \text{ V}$, $I = 10 \text{ mA}$ (normal operation), $I = 13 \text{ mA}$ (in the event of an error / FDE) Bus connection with integrated protection against polarity reversal</p>
--	---

Fig. 50: (I = internal, E = external)

5.8 Connection examples

5.8.1 Digital output DO2

E.g., for system monitoring, max. / min. alarm, empty meter tube or forward / reverse signal, or counting pulses (function can be configured using software)

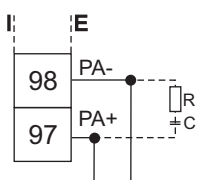
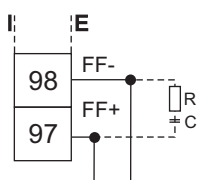
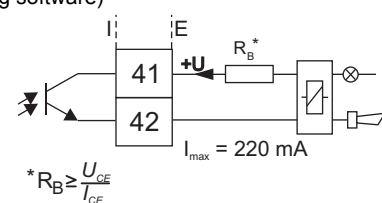

G00792-01

Fig. 51: (I = internal, E = external)

5.8.2 Digital outputs DO1 and DO2

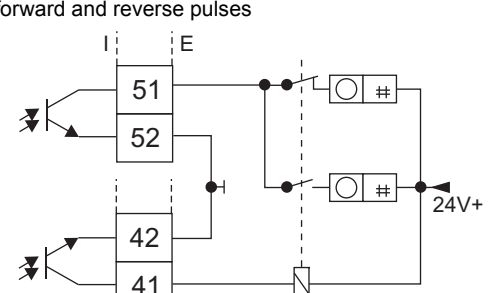
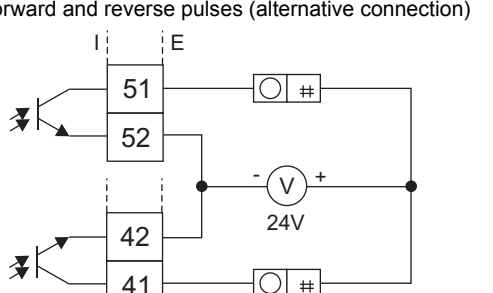
<p>Separate forward and reverse pulses</p> 	<p>Separate forward and reverse pulses (alternative connection)</p> 
--	--

G00791

Fig. 52: (I = internal, E = external)

5.8.3 PROFIBUS PA - Connection via M12 plug

Only in non-hazardous areas

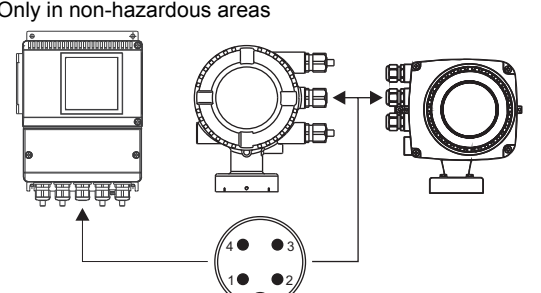

Pin assignment
 (Front view showing pin insert and pins)
 PIN 1 = PA+
 PIN 2 = nc
 PIN 3 = PA-
 PIN 4 = shield

G01003-01

Fig. 53



IMPORTANT (NOTE)

For additional information on configuring the current output, see chapter 7.2 „Configuring the current output“

6 Digital communication

6.1 HART protocol

The unit is registered with the HART Communication Foundation.

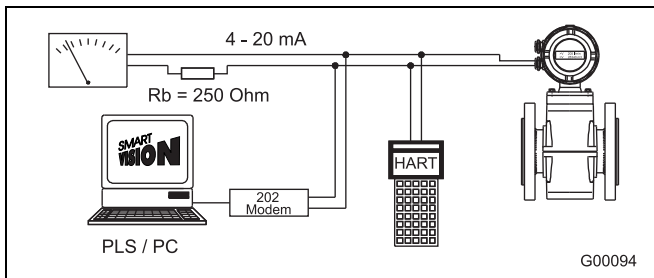

Fig. 54

Configuration	Directly on the device Software DAT200 Asset Vision Basic (+ HART-DTM)
Transmission	FSK modulation on current output 4 ... 20 mA acc. to Bell 202 standard
Max. signal amplitude	1.2 mA _{SS}
Current output load	Min. 250 Ω, max. = 560 Ω
Cable	AWG 24 twisted
Max. cable length	1500 m
Baud rate	1,200 baud
Display	Log. 1: 1,200 Hz Log. 0: 2,200 Hz

For additional information, see separate interface documentation.

6.1.1 System integration

In conjunction with the DTM (Device Type Manager) available for the device, communication (configuration, parameterization) can occur with the corresponding framework applications according to FDT 1.21 (DAT200 Asset Vision Basic).

Other tool/system integrations (e.g., Emerson AMS/Siemens PCS7) are available upon request.

A free of charge version of the DAT200 Asset Vision Basic framework application for HART® or PROFIBUS is available upon request.

The required DTMs are contained on the DAT200 Asset Vision Basic DVD or in the DTM Library.

They can also be downloaded from www.abb.com/flow.

6.2 PROFIBUS PA

The interface conforms to profile 3.01 (PROFIBUS standard, EN 50170, DIN 19245 [PRO91]).

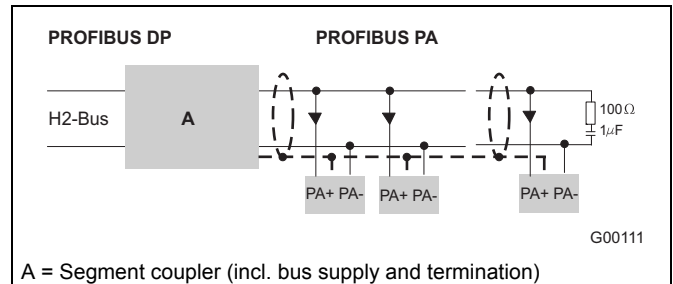

A = Segment coupler (incl. bus supply and termination)

Fig. 55: Example for PROFIBUS PA interface connection

PROFIBUS PA ID no	0x3430
Alternative standard ID no	0x9700 or 0x9740
Configuration	Directly on the device Software DAT200 Asset Vision Basic (+ PROFIBUS PA-DTM)
Transmission signal	Acc. to IEC 61158-2
Cable	Shielded, twisted cable (acc. to IEC 61158-2, types A or B are preferred)

6.2.1 Bus topology

- Tree and/or line structure
- Bus termination: passive at both ends of the main bus line (RC element R = 100 Ω, C = 1 μF)

6.2.2 Voltage / current consumption

- Average current consumption: 10 mA
- In the event of an error, the integrated FDE function (=Fault Disconnection Electronic) integrated in the device ensures that the current consumption can rise to a maximum of 13 mA.
- The upper current limit is restricted electronically.
- The voltage on the bus line must lie in the range of 9 ... 32 V DC.

For additional information, see separate interface documentation.

6.2.3 System integration

ABB provides three different GSD files (equipment master data) which can be integrated in the system.

Users decide at system integration whether to install the full range of functions or only part.

The change-over is done using the "ID-number selector" parameter.

ID number 0x9700, GSD file name: PA139700.gsd

ID number 0x9740, GSD file name: PA139740.gsd

ID number 0x3430, GSD file name: ABB_3430.gsd

The GSD files can be downloaded from www.abb.com/flow.

The files required for operation can be downloaded from www.profibus.com.

6.3 FOUNDATION fieldbus (FF)

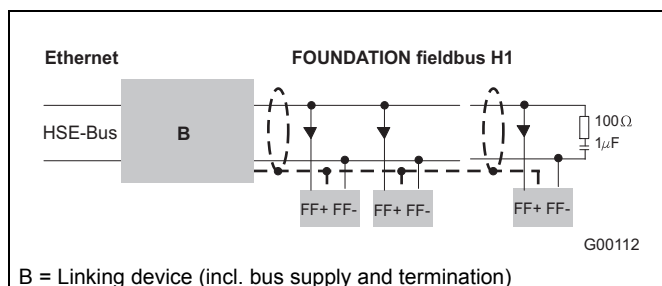

B = Linking device (incl. bus supply and termination)

Fig. 56: Example for FOUNDATION fieldbus interface connection

Interoperability test campaign no.	ITK 5.20
Manufacturer ID	0x000320
Device ID	0x0124
Configuration	<ul style="list-style-type: none"> • Directly on the device • Via services integrated in the system • National configurator
Transmission signal	Acc. to IEC 61158-2

6.3.1 Bus topology

- Tree and/or line structure
- Bus termination: passive at both ends of the main bus line (RC element $R = 100 \Omega$, $C = 1 \mu F$)

6.3.2 Voltage / current consumption

- Average current consumption: 10 mA
- In the event of an error, the integrated FDE function (=Fault Disconnection Electronic) integrated in the device ensures that the current consumption can rise to a maximum of 13 mA.
- Upper current limit: electronically restricted.
- The voltage on the bus line must lie in the range of 9 ... 32 V DC.

6.3.3 Bus address

The bus address is automatically assigned or can be set in the system manually.

The identifier (ID) is formed using a unique combination of manufacturer ID, device ID, and device serial number.

6.3.4 System integration

The following are required:

- DD (Device Description) file, which includes the device description.
- The CFF (Common File Format) file is required for engineering the segment. Engineering can be performed online or offline.

The files can be downloaded from www.abb.com/flow.

The files required for operation can also be downloaded from <http://www.fieldbus.org>.

7 Commissioning



IMPORTANT (NOTE)

An additional document with Ex safety instructions is available for measuring systems that are used in explosion hazardous areas. As a result, it is crucial that the specifications and data it lists are also observed.

7.1 Preliminary checks prior to start-up

The following points must be checked before commissioning:

- The supply power must be switched off.
- The supply power must match information on the name plate.
- The pin assignment must correspond to the connection diagram.
- Sensor and transmitter must be grounded properly.
- The temperature limits must be observed.
- The sensor must be installed at a largely vibration-free location.
- The housing cover and its safety locking device must be sealed before switching on the supply power.
- For devices with remote mount design and an accuracy of 0.2 % of rate make sure that the flowmeter sensor and the transmitter match correctly.
For this purpose, the final characters X1, X2, etc. are printed on the name plates of the flowmeter sensors, whereas the transmitters are identified by the final characters Y1, Y2, etc.
Devices with the end characters X1 / Y1 or X2 / Y2, etc. fit with each other.

7.2 Configuring the current output

The factory setting for the current output is 4 ... 20 mA.

For devices without explosion protection or for operation in Zone 2 / Div. 2 the following is valid:

The signal can be configured in "active" or "passive" mode. The current setting is contained in the order confirmation.

For devices for operation in Zone 1 / Div. 1 the following is valid:

For devices designed for use in Ex Zone 1 / Div.1, the current output cannot be reconfigured subsequently. The configuration required for the current output (active / passive) must be specified when the order is placed.

For the correct current output design (active / passive), see the marking contained in the device's terminal box.

If the signal is configured in "active" mode, no external power may be supplied to the current output.

If the signal is configured in "passive" mode, external power must be supplied to the current output (similar to pressure and temperature transmitters).

Commissioning

7.2.1 Transmitter with dual-compartment housing

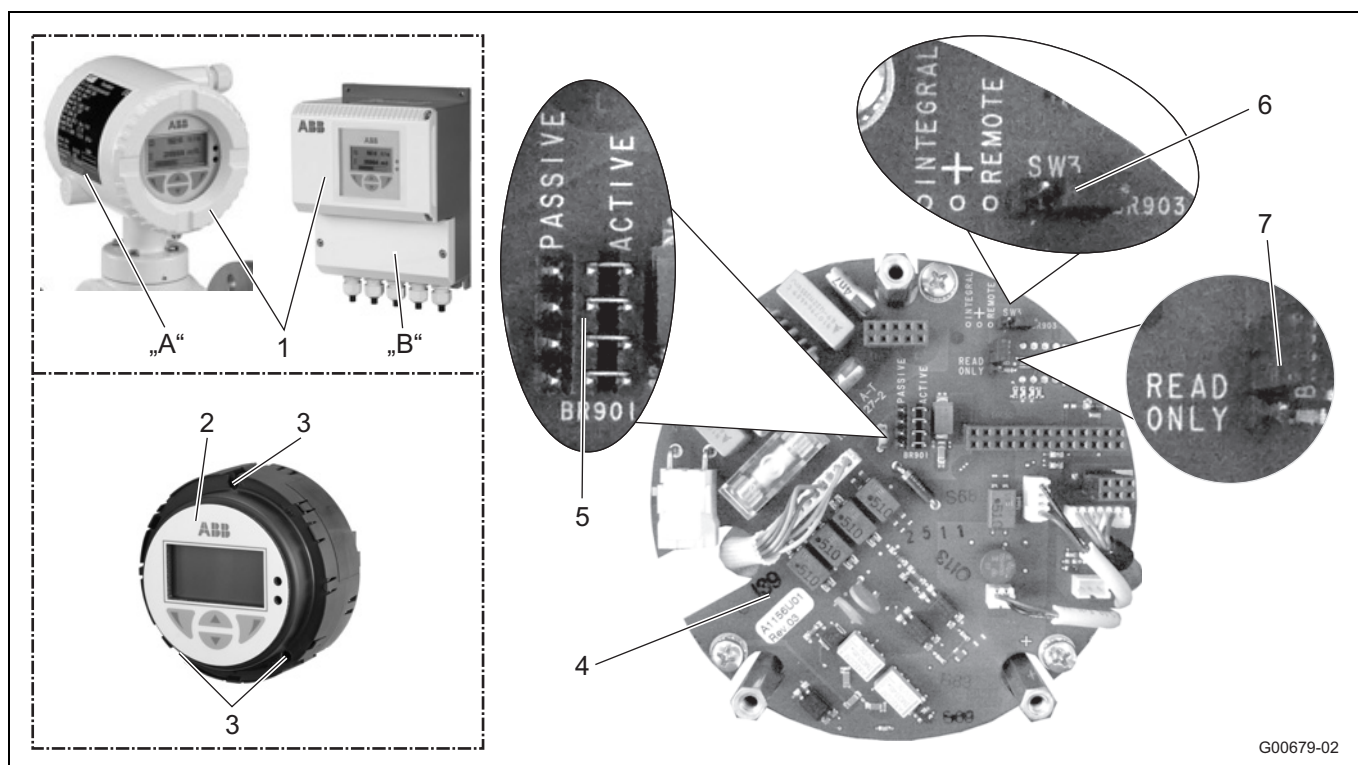

Fig. 57

- A Integral mount design
- B Remote mount design
- 1 Housing cover
- 2 Transmitter plug-in module
- 3 Fixing screws
- 4 Backplane (in the transmitter housing)
- 5 Jumper (BR901) for active / passive current output
- 6 Jumper (BR903) for integral / remote mount design
- 7 Jumper (BR902) for hardware write protection



IMPORTANT (NOTE)

The backplane is mounted in the transmitter housing (not the transmitter plug-in module).

Configure the outputs as follows:

1. Switch off power supply.
2. Open the housing cover.
3. Remove the mounting screws for the transmitter electronics unit
4. Pull out the transmitter electronics unit
5. Set jumpers on backplane in accordance with the following table.

Jumper	Number	Function
BR901	active	Current output 31 / 32 active
	passive	Current output 31 / 32 passive
BR902	Read only	Hardware write protection active
BR903	integral	Transmitter with integral mount design
	remote	Transmitter with remote mount design

6. Reinstall the transmitter electronic unit in reverse order

7.2.2 Transmitter with single-compartment housing

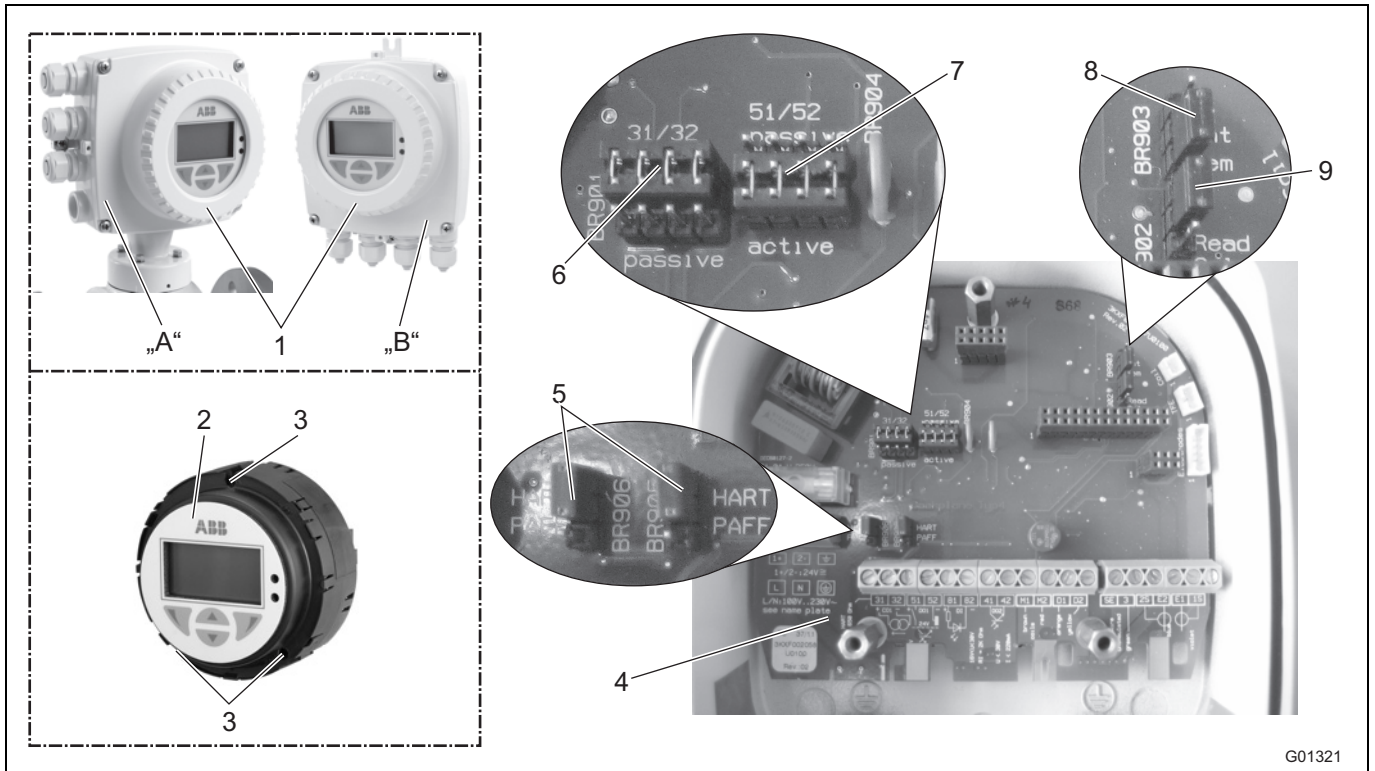

Fig. 58: Jumpers in the single-compartment housing

- A Integral mount design
- B Remote mount design
- 1 Housing cover
- 2 Transmitter plug-in module
- 3 Fixing screws
- 4 Backplane (in the transmitter housing)
- 5 Jumpers (BR905, BR906) for communication
- 6 Jumper (BR901) for active / passive current output
- 7 Jumper (BR904) for active / passive pulse output
- 8 Jumper (BR903) for integral / remote mount design
- 9 Jumper (BR902) for hardware write protection



IMPORTANT (NOTE)

The backplane is mounted in the transmitter housing (not the transmitter plug-in module).

Configure the outputs as follows:

1. Switch off power supply.
2. Open the housing cover.
3. Remove the mounting screws for the transmitter electronics unit
4. Pull out the transmitter electronics unit
5. Set jumpers on backplane in accordance with the following table.

Jumper	Number	Function
BR901	active	Current output 31 / 32 active
	passive	Current output 31 / 32 passive
BR902	Read only	Hardware write protection active
	integral	Transmitter with integral mount design
BR903	remote	Transmitter with remote mount design
	active	Pulse output 51 / 52 active
BR904	passive	Pulse output 51 / 52 passive
	BR905, BR906	HART
PA/FF		Digital communication via PROFIBUS PA or FOUNDATION Fieldbus

6. Install the transmitter in reverse order.

7.3 Start-up of PROFIBUS PA units

For units with PROFIBUS PA, the bus address must be checked or configured prior to start-up. If no bus address information was supplied by the customer, the unit was shipped with its BUS address set to "126".

The address must be set during start-up to a number within the valid range (0 ... 125).

**IMPORTANT (NOTE)**

The address selected may only appear once in the segment.

The PROFIBUS PA interface of the device conforms with Profile 3.01 (fieldbus standard PROFIBUS, EN 50170, alias DIN 19245 [PRO91]).

The transmitter transmission signal is designed according to IEC 61158-2.

**IMPORTANT (NOTE)**

The manufacturer-specific PROFIBUS PA ID no. is: 0x3430.

The unit can also be operated with the PROFIBUS standard ID nos. 0x9700 or 0x9740.

Address setting in the case of transmitters with dual-compartment housing

The address can be set either locally on the device (via the DIP switches on the backplane), using system tools, or via a PROFIBUS DP master class 2 such as Asset Vision Basic (DAT200).

The factory setting for DIP switch 8 is OFF, i.e., the address is set using the fieldbus.

The front cover must be unscrewed to change the settings. It is also possible to set the address via menu by using the keys on the display board.

Address setting in the case of transmitters with single-compartment housing

The address can be set using system tools or via a PROFIBUS DP master class 2 such as Asset Vision Basic (DAT200).

It is also possible to set the address via a menu by using the transmitter LCD display (refer to the the "Parameterization" section).

It is not possible to set the address locally via DIP switch because there are no DIP switches present in the case of transmitters with single-compartment housing.

7.3.1 Local address setting in the case of transmitters with dual-compartment housing

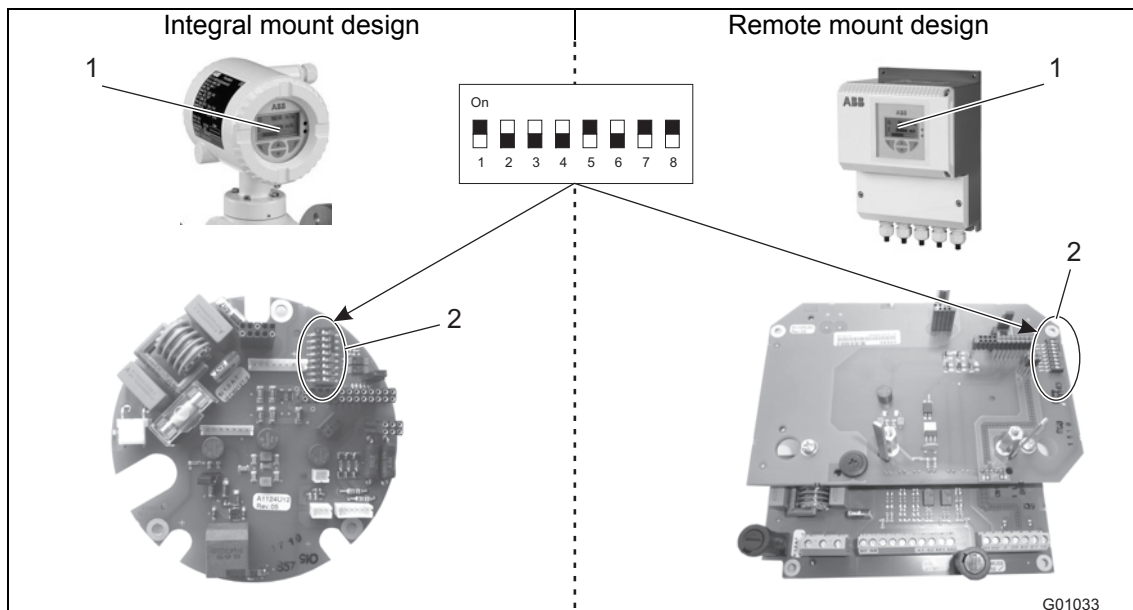

Fig. 59: Position of DIP switches

- 1 Transmitter plug-in module
- 2 DIP switch

Switch assignments

Switch	Assignment
1 ... 7	PROFIBUS address
8	Defines the addressing mode: Off = Set address via bus (factory setting) On = Set address via DIP switches 1 ... 7 (local)

Device behavior with power supply switched on

After the power supply has been switched on, DIP switch 8 is polled:

Status	
ON	The address defined by DIP switches 1 ... 7 applies. The address can no longer be changed via the bus once the device is in operation, since DIP switch 8 is polled only once when the power supply is turned on.
OFF (Default)	The transmitter uses the address stored in the FRAM of the gateway. At shipment the address is set to "126" or to the address specified by the customer. Once the unit is in operation, the address can be changed via the bus or directly on the unit using the keys on the display board. The unit must be connected to the bus.

Address setting

Switches 1, 5, 7 = ON means: $1+16+64 = 81 \rightarrow$ Bus address 81

Switch	1	2	3	4	5	6	7	8
Status	Device address							Address mode
Off	0	0	0	0	0	0	0	Bus
On	1	2	4	8	16	32	64	Local

Commissioning

7.3.2 Configuration in the case of transmitters with single-compartment housing

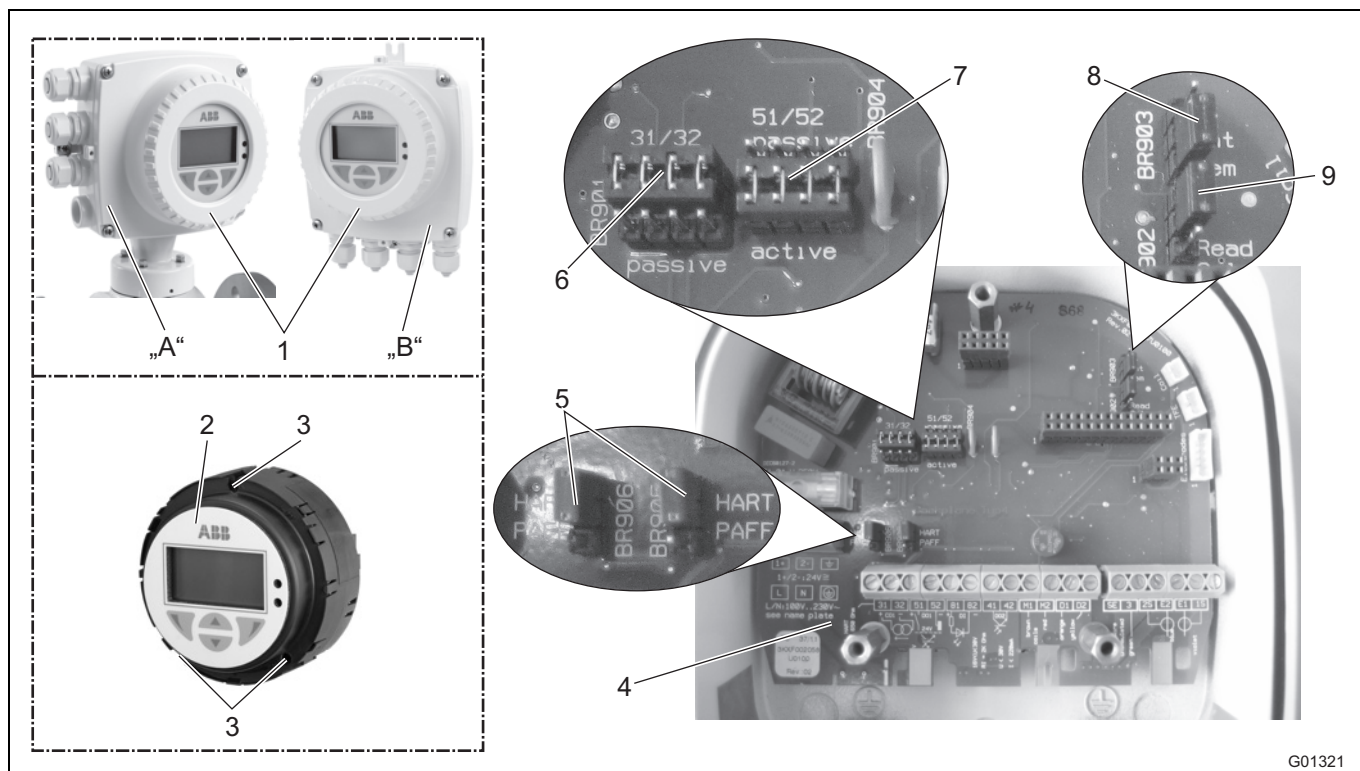

Fig. 60:

- A Integral mount design
- B Remote mount design
- 1 Housing cover
- 2 Transmitter plug-in module
- 3 Fixing screws
- 4 Backplane (in the transmitter housing)
- 5 Jumpers (BR905, BR906) for communication
- 6 Jumper (BR901) for active / passive current output
- 7 Jumper (BR904) for active / passive pulse output
- 8 Jumper (BR903) for integral / remote mount design
- 9 Jumper (BR902) for hardware write protection

Set jumpers on backplane in accordance with the following table.

Jumper	Number	Function
BR901	passive	For PROFIBUS PA, set position to "passive"
BR903	integral	Transmitter with integral mount design
	remote	Transmitter with remote mount design
BR904	active	For PROFIBUS PA without function
	passive	
BR905, BR906	PA/FF	Digital communication via PROFIBUS PA

7.3.3 Voltage / current consumption

- Average current consumption: 10 mA.
- In the event of an error, the integrated FDE (= Fault Disconnection Electronic) function integrated in the device ensures that the current consumption can rise to a maximum of 13 mA.
- The upper current limit is restricted electronically.
- The voltage on the bus line must lie in the range of 9 ... 32 V DC.

7.3.4 System integration

Use of PROFIBUS PA profile B, B3.01 ensures interoperability and interchangeability of devices. Interoperability means that devices from different manufacturers can be physically connected to a bus and are communication-ready. In addition, third-party devices can be interchanged without having to reconfigure the process control system.

To support interchangeability, ABB provides three different GSD files (equipment master data) that can be integrated in the system.

Users decide at system integration whether to install the full range of functions or only part.



IMPORTANT (NOTE)

Devices are interchanged using the parameter "ID number selector", which can only be modified on an acyclical basis.

The following table describes the available GSD files:

Number and type of function blocks	ID number	GSD file name
1 x AI	0x9700	PA139700.gsd
1 x AI; 1 x TOT	0x9740	PA139740.gsd
4 x AI, 2 x TOT, 1 x AO, 1 x DI, 1 x DO and all manufacturer-specific parameters	0x3430	ABB_3430.gsd

The manufacturer-specific GSD file "ABB_3430.gsd" is available to download from the ABB homepage <http://www.abb.com/flow>.

The standard "PA1397xx.gsd" GSD files are available for download from the Profibus International homepage: <http://www.profibus.com>

7.4 Start-up of FOUNDATION FIELDBUS devices

For devices with a FOUNDATION Fieldbus, the settings of the DIP switch must be checked prior to start-up.

The DIP switches on the unit must be set correctly as follows:

- DIP switch 1 must be OFF.
- DIP switch 2 must be OFF.

Otherwise, the hardware write protection and the process control system prevent the unit from recording information.

When integrating the unit in a process control system, a DD file (device description) and a CFF file (common file format) are required. The DD file contains the device description. The CFF file is required for segment engineering. Engineering can be performed online or offline.

The DD and CFF files are available to download from the ABB homepage <http://www.abb.com/flow>.

The FOUNDATION Fieldbus interface for the device is compliant with the standards FF-890/891 and FF-902/90. The transmission signal of the transmitter is designed in accordance with IEC 61158-2.

The device is registered with the FOUNDATION fieldbus.

Registration for the FOUNDATION fieldbus is recorded under Manufacturer ID 0x000320 and Device ID 0x0124.

7.4.1 Configuration of transmitters with dual-compartment housing

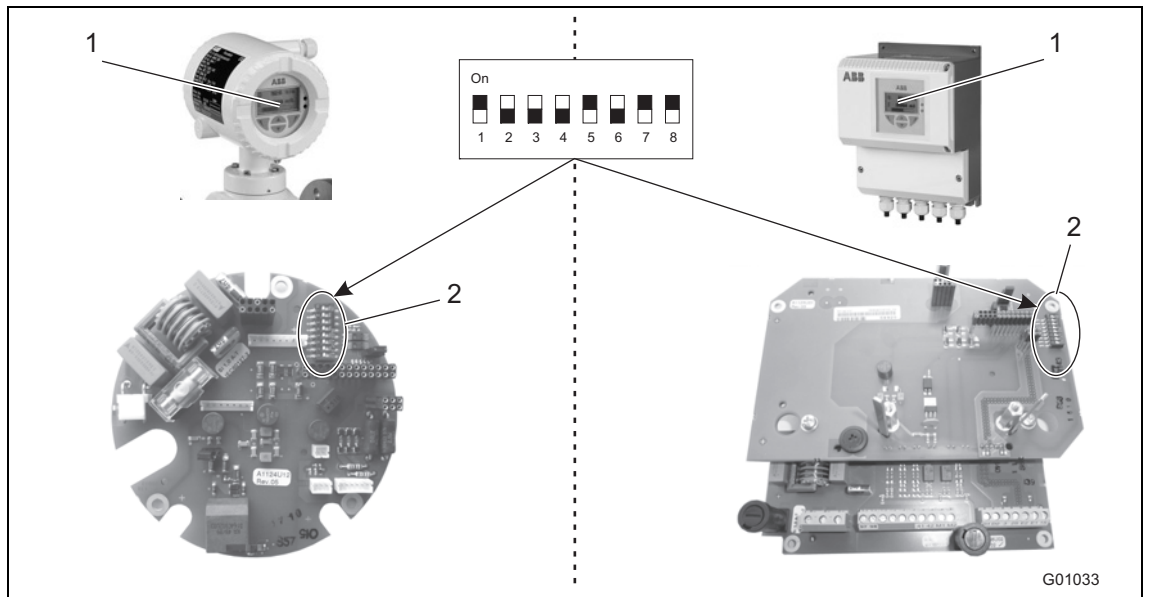

Fig. 61: Position of DIP switches

1 Transmitter plug-in module

2 DIP switch

Assigning of DIP switches

DIP switch 1:

Enables the simulation of the AI function blocks.

DIP switch 2:

Hardware write protection for write access via bus (locks all blocks).

DIP switch	1	2
Status	Simulation Mode	Write Protect
Off	Disabled	Disabled
On	Enabled	Enabled

Commissioning

7.4.2 Configuration of transmitters with single-compartment housing

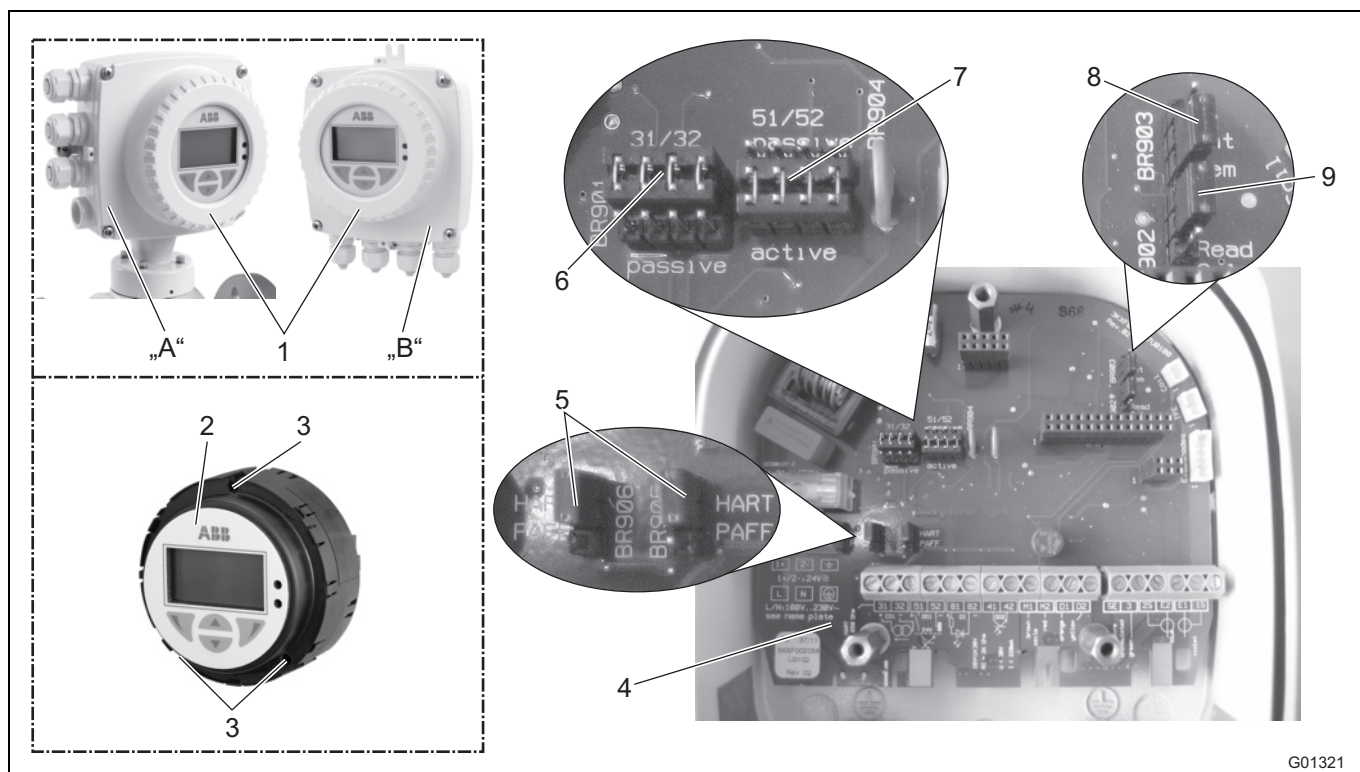

Fig. 62:

- A Integral mount design
- B Remote mount design
- 1 Housing cover
- 2 Transmitter plug-in module
- 3 Fixing screws
- 4 Backplane (in the transmitter housing)
- 5 Jumpers (BR905, BR906) for communication
- 6 Jumper (BR901) for active / passive current output
- 7 Jumper (BR904) for active / passive pulse output
- 8 Jumper (BR903) for integral / remote mount design
- 9 Jumper (BR902) for hardware write protection

Set jumpers on backplane in accordance with the following table.

Jumper	Number	Function
BR901	passive	For FOUNDATION Fieldbus, set position to "passive"
BR903	integral	Transmitter with integral mount design
	remote	Transmitter with remote mount design
BR904	active	For FOUNDATION Fieldbus without function
	passive	
BR905, BR906	PA/FF	Digital communication via FOUNDATION Fieldbus

7.4.3 Bus address settings

The bus address is automatically allocated at the FF via LAS (link active scheduler). For address detection, a unique number is used (DEVICE_ID). This number is a combination of manufacturer ID, device ID and device serial number.

The behavior when switching on the unit corresponds to Draft DIN IEC/65C/155/CDV of June 1996.

The mean current consumption of the device is 10 mA.

The voltage on the bus line must lie in the range of 9 ... 32 V DC.



IMPORTANT (NOTE)

The upper limit of the current is electronically limited. In the event of an error, the FDE (= Fault Disconnection Electronic) function integrated in the device ensures that the current consumption cannot exceed a maximum of 13 mA.

Commissioning

7.5 Commissioning the unit

7.5.1 Downloading the system data

- Switch on the power supply. After switching on the power supply, the following messages appear in succession on the LCD display:

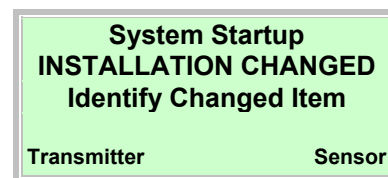
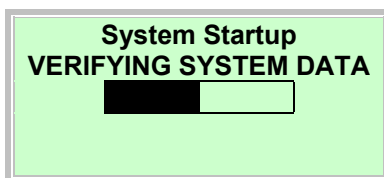
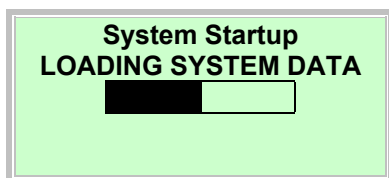

- Download the system data as follows:

For a completely new system or initial start-up

- The calibration data of the flowmeter sensor and the transmitter settings are loaded from the SensorMemory¹⁾ into the transmitter.

After replacing the complete transmitter or transmitter electronic unit

- Select "Transmitter" with . The calibration data of the flowmeter sensor and the transmitter settings are loaded from the SensorMemory¹⁾ into the transmitter.

After replacing the sensor

- Select "Sensor" with . The calibration data of the flowmeter sensor are loaded from the SensorMemory¹⁾ into the transmitter. The transmitter settings are stored in the SensorMemory¹⁾. If the new sensor is a different size, check the currently configured flow range.

- The flowmeter is ready for operation and will operate with factory settings or settings requested by the customer. To change the factory settings, refer to chapter 8 "Parameterization".

- The SensorMemory is a data memory integrated in the flowmeter sensor.



IMPORTANT (NOTE)

System data must only be loaded during initial start-up. If the power supply is later switched off, the transmitter automatically loads all data the next time the power supply is switched on again.

A selection as described below (1-3) is not required.

7.5.1.1 Error message "Incompatible sensor"



IMPORTANT (NOTE)

When commissioning the device, make sure that the transmitter is assigned to the sensor correctly. It is not possible to operate a flowmeter sensor of the 300 series with a transmitter of the 500 series.

If the transmitter is operated with a flowmeter sensor of another series, the following message appears on the transmitter display:

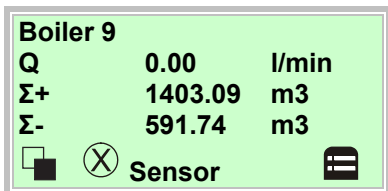

In the process display, a flow of zero flow is indicated, no flow measurement is performed.

1. Use to switch to the information level.

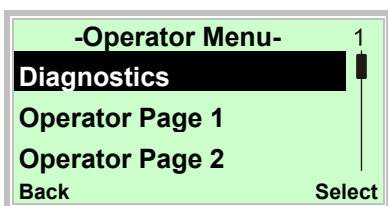

2. Use or , select the "Diagnostics" submenu.

3. Use to confirm your selection.

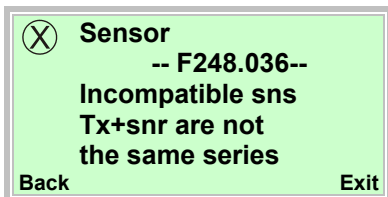

When attempting to commission a mixed installation, the shown error message appears.

The device cannot measure.

The indicated value for the current flowrate is zero flow.

The current output assumes its pre-configured state (lout for alarm).

Make sure that the flowmeter sensor and the transmitter are from the same series.

(e.g., flowmeter sensor ProcessMaster 300, transmitter ProcessMaster 300)

7.5.2 Parameterization via the "Commissioning" menu function

The device can be factory parameterized to customer specifications upon request.

If no customer information is available, the device is delivered with factory settings.

The setting of the most current parameters is summarized in the "Commissioning" menu. This menu provides the quickest way to configure the device.

The "Commissioning" menu allows you to select the language, the physical unit for flow rate, the measuring range, the totalizer unit, the pulse / frequency mode, the pulse per unit, the pulse width, damping, and the status of the current output during an alarm (Iout for alarm, Iout: Low Alarm, Iout: High Alarm).

For detailed descriptions of these menus and parameters, see the chapter on the "Parameter overview".

The following section describes parameterization via the "Easy Setup" menu function.

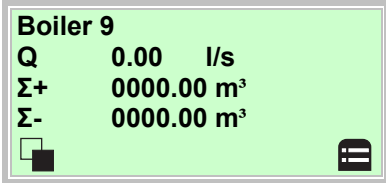

4. Use to switch to the configuration level.

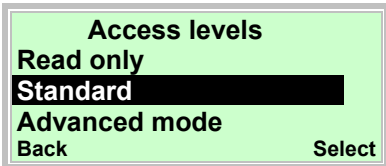

5. Use or to select "Standard".

6. Confirm the selection with .

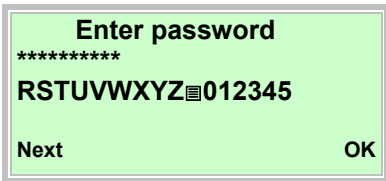

7. Use to confirm the password. A password is not available as factory default; you can continue without entering a password.



8. Use or to select "Commissioning".

9. Confirm the selection with .



10. Use to call up the edit mode.
11. Use or to select the desired language.
12. Confirm the selection with .

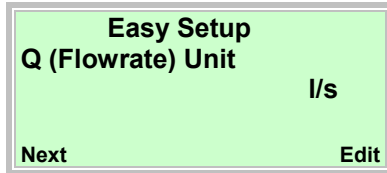

13. Use to call up the edit mode.
14. Use or to select the desired unit.
15. Confirm the selection with .

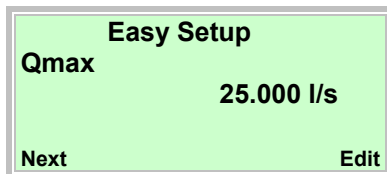

16. Use to call up the edit mode.
17. Use or to set the desired upper range value.
18. Use to confirm your setting.

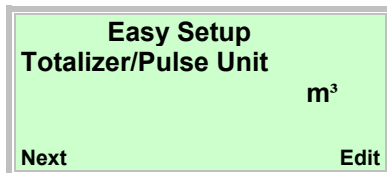

19. Use to call up the edit mode.
20. Use or to select the desired unit.
21. Confirm the selection with .

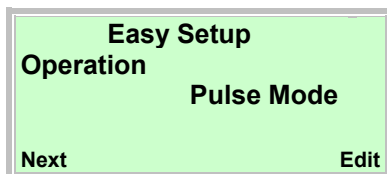

22. Use to call up the edit mode.
 23. Use or to select the required operating mode.
 - "Pulse Mode": In pulse mode, pulses per unit are output. The relevant settings are provided in the next menu
 - "Fullscale Frequency": In frequency mode, a frequency proportional to the flow rate is output. The maximum frequency can be configured according to the flow measuring range
- The factory default for the operating mode is "Pulse Mode".
24. Confirm the selection with .

Easy Setup
Pulses per Unit
 10.000 / m³
 Next Edit

- 25. Use to call up the edit mode.
- 26. Use or to set the desired value.
- 27. Use to confirm your setting.

Easy Setup
Pulse Width
 30.00 ms
 Next Edit

- 28. Use to call up the edit mode.
- 29. Use or to set the required pulse width.
- 30. Use to confirm your setting.

Easy Setup
Damping
 30.00 ms
 Next Edit

- 31. Use to call up the edit mode.
- 32. Use or to set the desired damping.
- 33. Use to confirm your setting.

Easy Setup
lout at Alarm
 High Alarm
 Next Edit

- 34. Use to call up the edit mode.
- 35. Use or to select the alarm mode.
- 36. Confirm the selection with .

Easy Setup
Low Alarm Value
 3.5000 mA
 Next Edit

- 37. Use to call up the edit mode.
- 38. Use or to set the required current for Low Alarm.
- 39. Confirm the selection with .

Easy Setup
High Alarm Value
 21.800 mA
 Next Edit

- 40. Use to call up the edit mode.
- 41. Use or to set the required current for High Alarm.
- 42. Confirm the selection with .

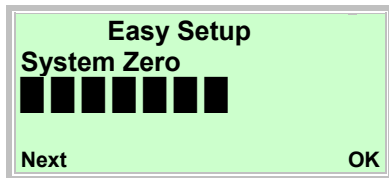

43. Use to start automatic balancing of the zero point for the system.

i IMPORTANT (NOTE)

Prior to starting the zero point balancing, make sure that:

- There is no flow through the sensor (close all valves, shut-off devices etc.)
- The sensor is completely filled with the medium to be measured

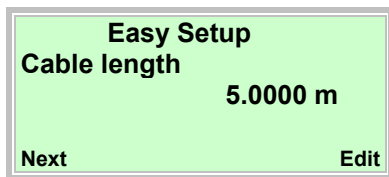

Enter the signal cable length between the transmitter and the sensor. For devices with an integral mount design 0.01 m must be entered.

44. Use to call up the edit mode.

45. Use or to set the signal cable length.

46. Confirm the selection with .



Once all parameter have been set, the main menu appears again. The most important parameters are now set.

47. Use to switch to the process display.

i IMPORTANT (NOTE)

- For additional information regarding operation of the LCD display, refer to chapter "8.1 „Operation“".
- For detailed descriptions of all menus and parameters, see chapter 8.4 „Description of parameters“.

The LCD display is provided with capacitive control buttons. These enable you to control the device through the glass of the closed cover.

i IMPORTANT (NOTE)

The transmitter automatically calibrates the capacitive control buttons on a regular basis. If the cover should be opened during operation, the buttons' sensitivity is at first increased. As a result, operating errors may occur. The button sensitivity will return to normal during the next automatic calibration.

Instructions on using the Q_{max} menu (flow range end value)

The device is factory calibrated to the flow range end value Q_{maxDN} , unless other customer information is available. The ideal flow range end values are approximately 2-3 m/s (0.2 ... 0.3 x Q_{maxDN}).

The smallest and largest possible flow range end values are shown in the table in chapter 7.6 "Flowmeter sizes, flow range".

Information regarding factory settings for further parameters (unless customer has requested a specific parameterization)

	Possible parameter settings	Factory setting
Q_{max}	Depending on the size (see table)	Q_{maxDN} (see table)
Sensor TAG	Alphanumeric, max. 20 characters	None
Sensor Location TAG	Alphanumeric, max. 20 characters	None
Q (Flowrate) Unit	l/s; l/min; l/h; ml/s; ml/min; m3/s; m3/min; m3/h; m3/d; hl/h; g/s; g/min; g/h; kg/s; kg/min; kg/h; kg/d; t/min; t/h; t/d	l/min
Totalizer/Pulse Unit	m3; l; ml; hl; g; kg; t	l
Pulses per Unit		1
Pulse Width	0,1 ... 2,000 ms	100 ms
Damping (1 Tau)	0,02 ... 60 sec.	1
DO1 Alarm Config	Pulse F/Pulse R, Pulse F, General Alarm, Min. Flowrate Alarm, Max. Flowrate Alarm, Empty Pipe, TFE Only available for FEP500 / FEH500 are: Gas Bubble, Conductivity, Coating, Sensor Temp	Pulse F/Pulse R
DO1 Action	Active, Passive	Passive
DO2 Alarm Config	F/R Signal, Pulse R, General Alarm, Min. Flowrate Alarm, Max. Flowrate Alarm, Empty Pipe, TFE Only available for FEP500 / FEH500 are: Gas Bubble, Conductivity, Coating, Sensor Temp	F/R Signal

	Possible parameter settings	Factory setting
Digital Input Setup	No Function, Totalizer Reset(All), Flowrate to Zero, System Zero Adjust, Totalizer Stop(All), Only available for FEP500 / FEH500 are: Dual Range, Start/Stop Batching	Flowrate to Zero
Current Output	4 ... 20 mA, 4 ... 12 ... 20 mA	4 - 20 mA
Output at Alarm	High Alarm, can be set to 21 ... 23 mA or Low Alarm, can be set to 3.5 ... 3.6 mA	High Alarm, 21.8 mA For details refer to Section 9.2.
Output at Flow >103%	Off (no signaling, current output holds 20.5 mA), High Alarm, Low Alarm	Off
Low Flow Cut Off	0 ... 10 %	1 %
Empty Pipe Detector	On / Off	Off
TFE Detector	On / Off	Off

For PROFIBUS PA version

	Possible parameter settings	Factory setting
PA Addr. (BUS)	0 ... 126	126
ID Nr Selector	0x9700, 0x9740, 0x3430	0x3430

Commissioning

7.6 Flowmeter sizes, flow range

The flow range end value can be set between $0.02 \times Q_{\max DN}$ and $2 \times Q_{\max DN}$.

Nominal diameter		Min. flow range end value	$Q_{\max DN}$	Max. flow range end value
DN	"	$0.02 \times Q_{\max DN} (\approx 0.2 \text{ m/s})$	$0 \dots \approx 10 \text{ m/s}$	$2 \times Q_{\max DN} (\approx 20 \text{ m/s})$
1	1/25	0,012 l/min (0,0032 US gal/min)	0,6 l/min (0,16 US gal/min)	1,2 l/min (0,32 US gal/min)
1,5	1/16	0,024 l/min (0,0063 US gal/min)	1,2 l/min (0,32 US gal/min)	2,4 l/min (0,63 US gal/min)
2	1/12	0,04 l/min (0,0106 US gal/min)	2 l/min (0,53 US gal/min)	4 l/min (1,06 US gal/min)
3	1/10	0,08 l/min (0,02 US gal/min)	4 l/min (1,06 US gal/min)	8 l/min (2,11 US gal/min)
4	5/32	0,16 l/min (0,04 US gal/min)	8 l/min (2,11 US gal/min)	16 l/min (4,23 US gal/min)
6	1/4	0,4 l/min (0,11 US gal/min)	20 l/min (5,28 US gal/min)	40 l/min (10,57 US gal/min)
8	5/16	0,6 l/min (0,16 US gal/min)	30 l/min (7,93 US gal/min)	60 l/min (15,85 US gal/min)
10	3/8	0,9 l/min (0,24 US gal/min)	45 l/min (11,9 US gal/min)	90 l/min (23,78 US gal/min)
15	1/2	2 l/min (0,53 US gal/min)	100 l/min (26,4 US gal/min)	200 l/min (52,8 US gal/min)
20	3/4	3 l/min (0,79 US gal/min)	150 l/min (39,6 US gal/min)	300 l/min (79,3 US gal/min)
25	1	4 l/min (1,06 US gal/min)	200 l/min (52,8 US gal/min)	400 l/min (106 US gal/min)
32	1 1/4	8 l/min (2,11 US gal/min)	400 l/min (106 US gal/min)	800 l/min (211 US gal/min)
40	1 1/2	12 l/min (3,17 US gal/min)	600 l/min (159 US gal/min)	1200 l/min (317 US gal/min)
50	2	1.2 m ³ /h (5.28 US gal/min)	60 m ³ /h (264 US gal/min)	120 m ³ /h (528 US gal/min)
65	2 1/2	2.4 m ³ /h (10.57 US gal/min)	120 m ³ /h (528 US gal/min)	240 m ³ /h (1057 US gal/min)
80	3	3.6 m ³ /h (15.9 US gal/min)	180 m ³ /h (793 US gal/min)	360 m ³ /h (1585 US gal/min)
100	4	4.8 m ³ /h (21.1 US gal/min)	240 m ³ /h (1057 US gal/min)	480 m ³ /h (2113 US gal/min)
125	5	8.4 m ³ /h (37 US gal/min)	420 m ³ /h (1849 US gal/min)	840 m ³ /h (3698 US gal/min)
150	6	12 m ³ /h (52.8 US gal/min)	600 m ³ /h (2642 US gal/min)	1200 m ³ /h (5283 US gal/min)
200	8	21.6 m ³ /h (95.1 US gal/min)	1080 m ³ /h (4755 US gal/min)	2160 m ³ /h (9510 US gal/min)
250	10	36 m ³ /h (159 US gal/min)	1800 m ³ /h (7925 US gal/min)	3600 m ³ /h (15850 US gal/min)
300	12	48 m ³ /h (211 US gal/min)	2400 m ³ /h (10567 US gal/min)	4800 m ³ /h (21134 US gal/min)
350	14	66 m ³ /h (291 US gal/min)	3300 m ³ /h (14529 US gal/min)	6600 m ³ /h (29059 US gal/min)
400	16	90 m ³ /h (396 US gal/min)	4500 m ³ /h (19813 US gal/min)	9000 m ³ /h (39626 US gal/min)
450	18	120 m ³ /h (528 US gal/min)	6000 m ³ /h (26417 US gal/min)	12000 m ³ /h (52834 US gal/min)
500	20	132 m ³ /h (581 US gal/min)	6600 m ³ /h (29059 US gal/min)	13200 m ³ /h (58117 US gal/min)
600	24	192 m ³ /h (845 US gal/min)	9600 m ³ /h (42268 US gal/min)	19200 m ³ /h (84535 US gal/min)
700	28	264 m ³ /h (1162 US gal/min)	13200 m ³ /h (58118 US gal/min)	26400 m ³ /h (116236 US gal/min)
760	30	312 m ³ /h (1374 US gal/min)	15600 m ³ /h (68685 US gal/min)	31200 m ³ /h (137369 US gal/min)
800	32	360 m ³ /h (1585 US gal/min)	18000 m ³ /h (79252 US gal/min)	36000 m ³ /h (158503 US gal/min)
900	36	480 m ³ /h (2113 US gal/min)	24000 m ³ /h (105669 US gal/min)	48000 m ³ /h (211337 US gal/min)
1000	40	540 m ³ /h (2378 US gal/min)	27000 m ³ /h (118877 US gal/min)	54000 m ³ /h (237754 US gal/min)
1050	42	616 m ³ /h (2712 US gal/min)	30800 m ³ /h (135608 US gal/min)	61600 m ³ /h (271217 US gal/min)
1100	44	660 m ³ /h (3038 US gal/min)	33000 m ³ /h (151899 US gal/min)	66000 m ³ /h (290589 US gal/min)
1200	48	840 m ³ /h (3698 US gal/min)	42000 m ³ /h (184920 US gal/min)	84000 m ³ /h (369841 US gal/min)
1400	54	1080 m ³ /h (4755 US gal/min)	54000 m ³ /h (237755 US gal/min)	108000 m ³ /h (475510 US gal/min)
1500	60	1260 m ³ /h (5548 US gal/min)	63000 m ³ /h (277381 US gal/min)	126000 m ³ /h (554761 US gal/min)
1600	66	1440 m ³ /h (6340 US gal/min)	72000 m ³ /h (317006 US gal/min)	144000 m ³ /h (634013 US gal/min)
1800	72	1800 m ³ /h (7925 US gal/min)	90000 m ³ /h (396258 US gal/min)	180000 m ³ /h (792516 US gal/min)
2000	80	2280 m ³ /h (10039 US gal/min)	114000 m ³ /h (501927 US gal/min)	228000 m ³ /h (1003853 US gal/min)

8 Parameterization

8.1 Operation

The LCD display is provided with capacitive control buttons. These enable you to control the device through the glass of the closed cover.



IMPORTANT (NOTE)

The transmitter automatically calibrates the capacitive control buttons on a regular basis. If the cover should be opened during operation, the buttons' sensitivity is at first increased. As a result, operating errors may occur. The button sensitivity will return to normal during the next automatic calibration.

8.1.1 Menu navigation

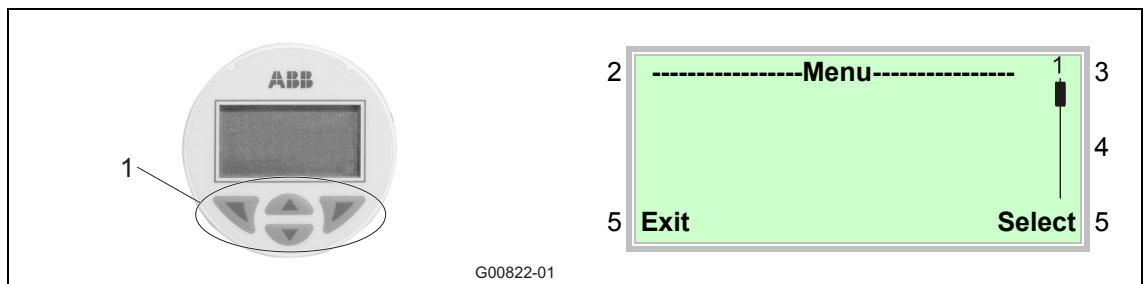

Fig. 63: LCD-indicator

- 1 Control buttons for menu navigation
- 2 Menu name
- 3 Menu number
- 4 Marker for indicating relative position within the menu
- 5 Function currently assigned to the and control buttons

You can use the or control buttons to browse through the menu or select a number or character within a parameter value.

Different functions can be assigned to the and control buttons. The function that is currently assigned to them (5) is shown on the display.

8.1.1.1 Control button functions

	Meaning
Exit	Exit menu
Back	Go back one submenu
Cancel	Cancel a parameter entry
Next	Select the next position for entering numerical and alphanumeric values

	Meaning
Select	Select submenu / parameter
Edit	Edit parameter
OK	Save parameter entered

8.2 Menu levels

Two levels exist under the process display.

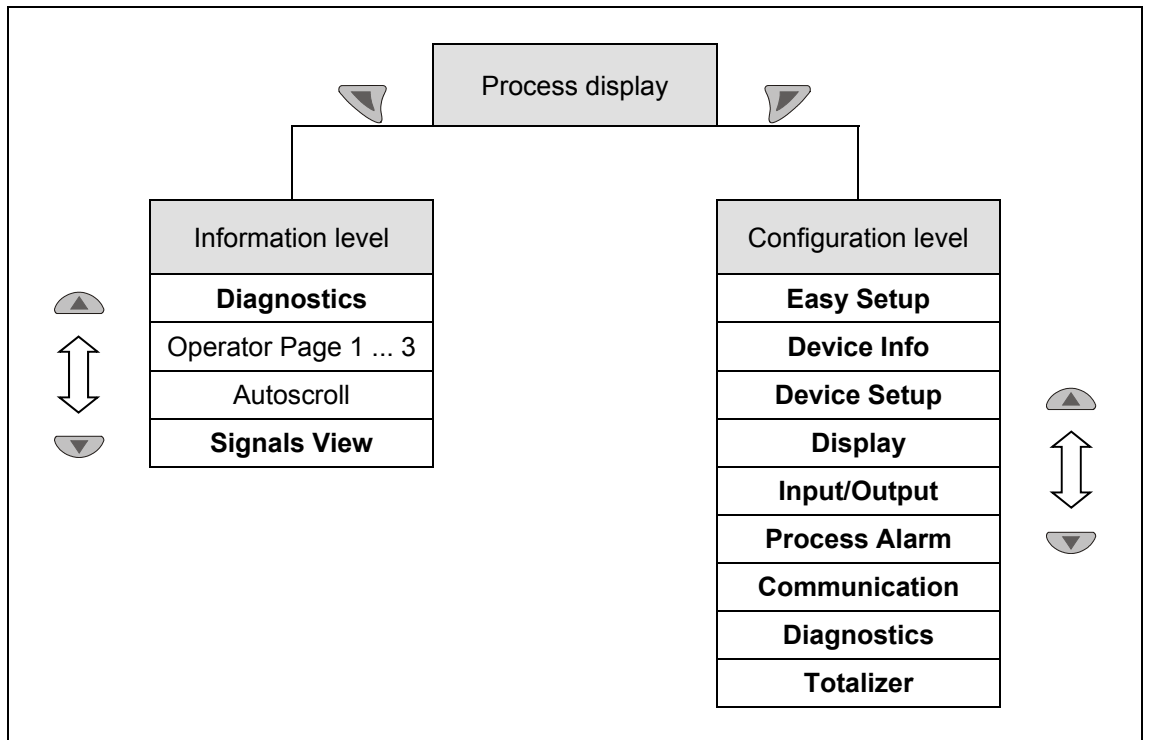

Fig. 64: Menu levels

Process display

The process display shows the current process values.

Information level

The information level contains the parameters and information that are relevant for the user. The device configuration cannot be changed on this level.

Configuration level

The configuration level contains all the parameters required for device commissioning and configuration. The device configuration can be changed on this level.

Note

For a detailed description of the individual parameters and menus on the configuration level refer to the sections 8.3 "Overview of parameters on the configuration level" and 8.4 "Description of parameters".

8.2.1 Process display

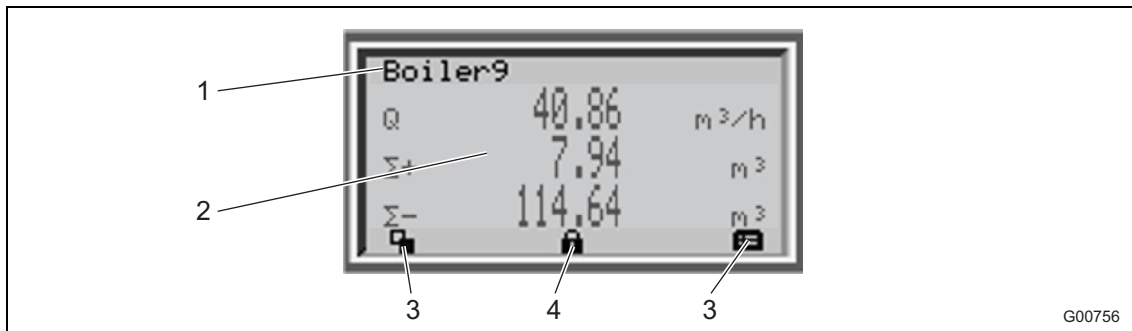





Fig. 65: Process display (example)

- | | |
|---|--|
| <p>1 Measuring point identifier</p> <p>2 Current process values</p> | <p>3 Symbol indicating button function</p> <p>4 Symbol indicating "Parameterization protected"</p> |
|---|--|

The process display appears on the LC display when the device is switched on. It shows information about the device and current process values.

The way in which the current process values (2) are shown can be adjusted on the configuration level.

8.2.1.1 Description of symbols

Symbol	Description
	Call up information level. When Autoscroll mode is enabled, a \cup symbol appears here and the operator pages are automatically displayed one after the other.
	Call up configuration level.
	The device is protected against changes to the parameter settings.
Q	Display of the current flowrate
$\Sigma+$	Totalizer status in forward direction
$\Sigma-$	Totalizer status in reverse direction

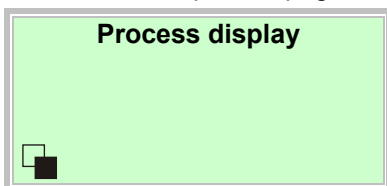

8.2.2 Switching to the information level (operator menu)

On the information level, the operator menu can be used to display diagnostic information and choose which operator pages to display.

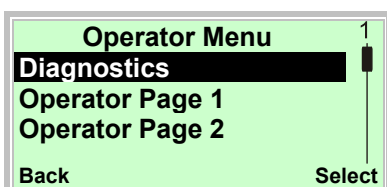

1. Use  to switch to the information level.



2. Use  or  to select a submenu.
3. Use  to confirm your selection.



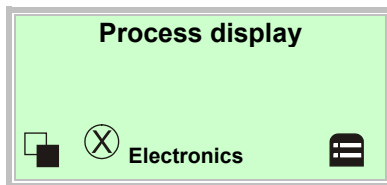

Menu	Description
... / Operator Menu	
Diagnostics	Selects the "Diagnostics" submenu, see also Chapter 8.2.2.1 "Error messages on the LCD display".
Operator Page 1	Selects the operator page to be displayed
Operator Page 2	
Operator Page 3	
Operator Page 4	
Autoscroll	When "Multiplex Mode" is enabled, this initiates automatic switching of the operator pages on the process display.
Signals View	Selects the "Signals View" submenu (for service, only).

8.2.2.1 Error messages on the LCD display

In case of an error, a message consisting of an icon and text appears at the bottom of the process display. The text displayed provides information about the area in which the error has occurred.



The error messages are divided into four groups in accordance with the NAMUR classification scheme:

Symbol	Description
	Error / Failure
	Functional check
	Out of specification
	Maintenance required

Additionally, the error messages are divided into the following areas:

Area	Description
Electronics	Error / alarm of the electronics.
Sensor	Error / alarm of the flowmeter sensor.
Status	Alarm due to the current device status.
Operation	Error / alarm due to the current operating conditions.

8.2.2.2 Invoking the error description

Additional details about the occurred error can be called up on the information level.

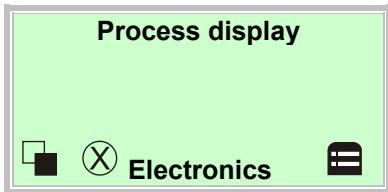

1. Use to switch to the information level.

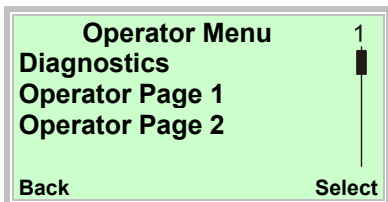

2. Use or , select the "Diagnostics" submenu.

3. Use to confirm your selection.

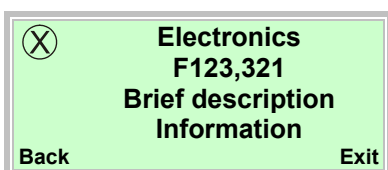

The first line shows the area in which the error has occurred.

The second line shows the unique error number.

The next lines show a brief description of the error and information on how to remedy it.

Note

For a detailed description of the errors and information on their remedy refer to Chapter 10 "Error messages".

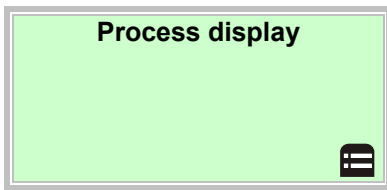

8.2.3 Switching to the configuration level (parameterization)

The device parameters can be displayed and changed on the configuration level.

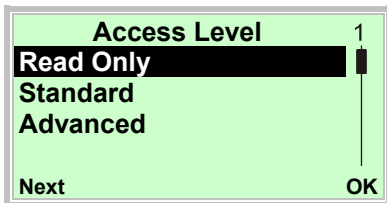

1. Use  to switch to the information level.



2. Use  or  to select the access level.

3. Use  to confirm your selection.



IMPORTANT (NOTE)

There are four access levels: For the **"Standard"** and **"Advanced"** levels you can define passwords. There are no factory default passwords.

- On the **"Read Only"** level all entries are disabled. Parameters are read only and cannot be modified.
- On the **"Standard"** level you can edit all parameters described in Chapter 8.4 "Description of parameters" except for those written in *italics*.
- On the **"Advanced"** level all parameters can be modified.
- The **Service menu** is reserved to the customer service.

Once you have logged on to the corresponding access level, you can edit or reset the password. Resetting to the "No password defined" state is done by selecting "☐" as the password.

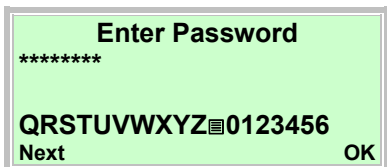

4. Enter the corresponding password (see Chapter "Selecting and changing parameters"). There is no factory default for the password. You can switch to the configuration level without entering a password. The selected access level remains active for 3 minutes. Within this time period you can toggle between the process display and the configuration level without re-entering the password.

5. Use  to confirm your password.

The LCD display now indicates the first menu item on the configuration level.

6. Use  or  to select a menu.

7. Use  to confirm your selection.

Parameterization

8.2.4 Hardware write protection

In addition to password protection, it is possible to activate hardware write protection.

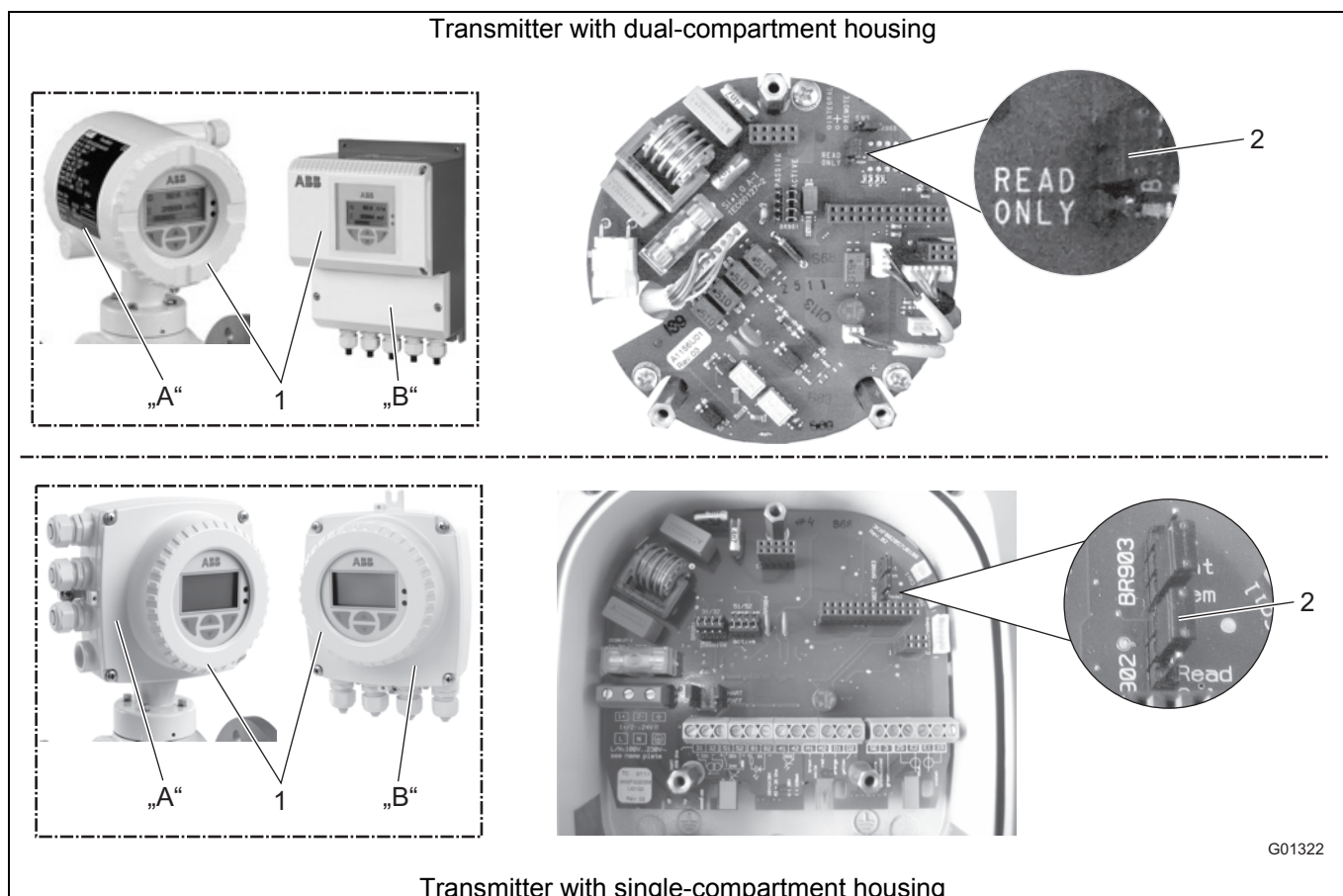

Fig. 66: Jumper for hardware write protection

- A Integral mount design
- B Remote mount design

- 1 Housing cover
- 2 Jumper (BR902) for hardware write protection

1. Switch off power supply.
2. Open the housing cover.
3. Remove the mounting screws for the transmitter electronics unit
4. Pull out the transmitter electronics unit
5. Set jumpers on backplane in accordance with the following table.

Jumper	Number	Function
BR902	Read only	Hardware write protection active

6. Reinstall the transmitter electronic unit in reverse order

8.2.5 Selecting and changing parameters

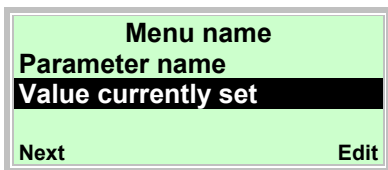

8.2.5.1 Entry from table

When an entry is made from a table, a value is selected from a list of parameter values.

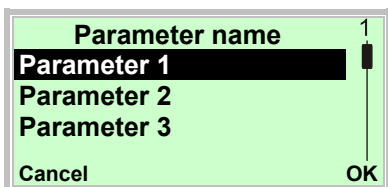

1. Select the parameters you want to set in the menu.
2. Use  to call up the list of available parameter values. The parameter value that is currently set is highlighted.



3. Use  or  to select the required value.
 4. Use  to confirm your selection.
- This concludes the procedure for selecting a parameter value.



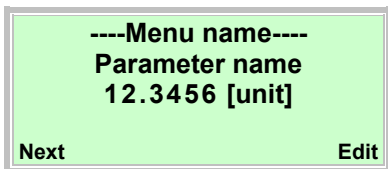

8.2.5.2 Numerical entry

When a numerical entry is made, a value is set by entering the individual decimal positions.

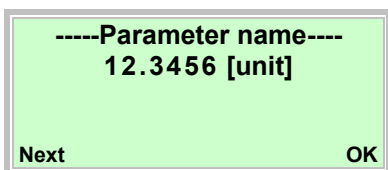

1. Select the parameters you want to set in the menu.
2. Use  to call up the parameter for editing. The position that is currently selected is highlighted.



3. Use  to select the decimal position to be changed.
 4. Use  or  to set the required value.
 5. Use  to select the next decimal position.
 6. If necessary, select and set other decimal positions using the same procedure as described in steps 3 and 4.
 7. Use  to confirm your setting.
- This concludes the procedure for changing a parameter value.

8.2.5.3 Alphanumeric entry

When an alphanumeric entry is made, a value is set by entering the individual decimal positions.

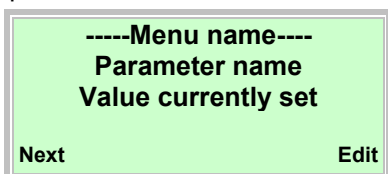

1. Select the parameters you want to set in the menu.
2. Use to call up the parameter value for editing. The position that is currently selected is highlighted.

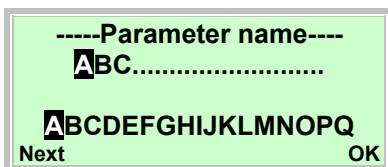

3. Use to select the position to be changed.
 4. Use or to select the required character.
 5. Use to select the next position.
 6. If necessary, select and set other decimal positions using the same procedure as described in steps 3 and 4.
 7. Use to confirm your setting.
- This concludes the procedure for changing a parameter value.

8.2.5.4 Exiting the setup

For some menu items, values must be entered. If you don't want to change the parameter, you can exit the menu as described below.

- 1 By pressing (Next) repeatedly you can move the cursor to the right. Once the cursor reaches the end position, "Cancel" is displayed in the lower right.
- 2 With you can terminate editing and exit the menu item. With you can return to the start.



IMPORTANT (NOTE)

The LCD display automatically returns to the process display three minutes after the last button has been actuated.

8.3 Overview of parameters on the configuration level



IMPORTANT (NOTE)

This overview of parameters shows all the menus and parameters available on the device. Depending on the version and configuration of the device, not all of the menus and parameters may be visible on it.

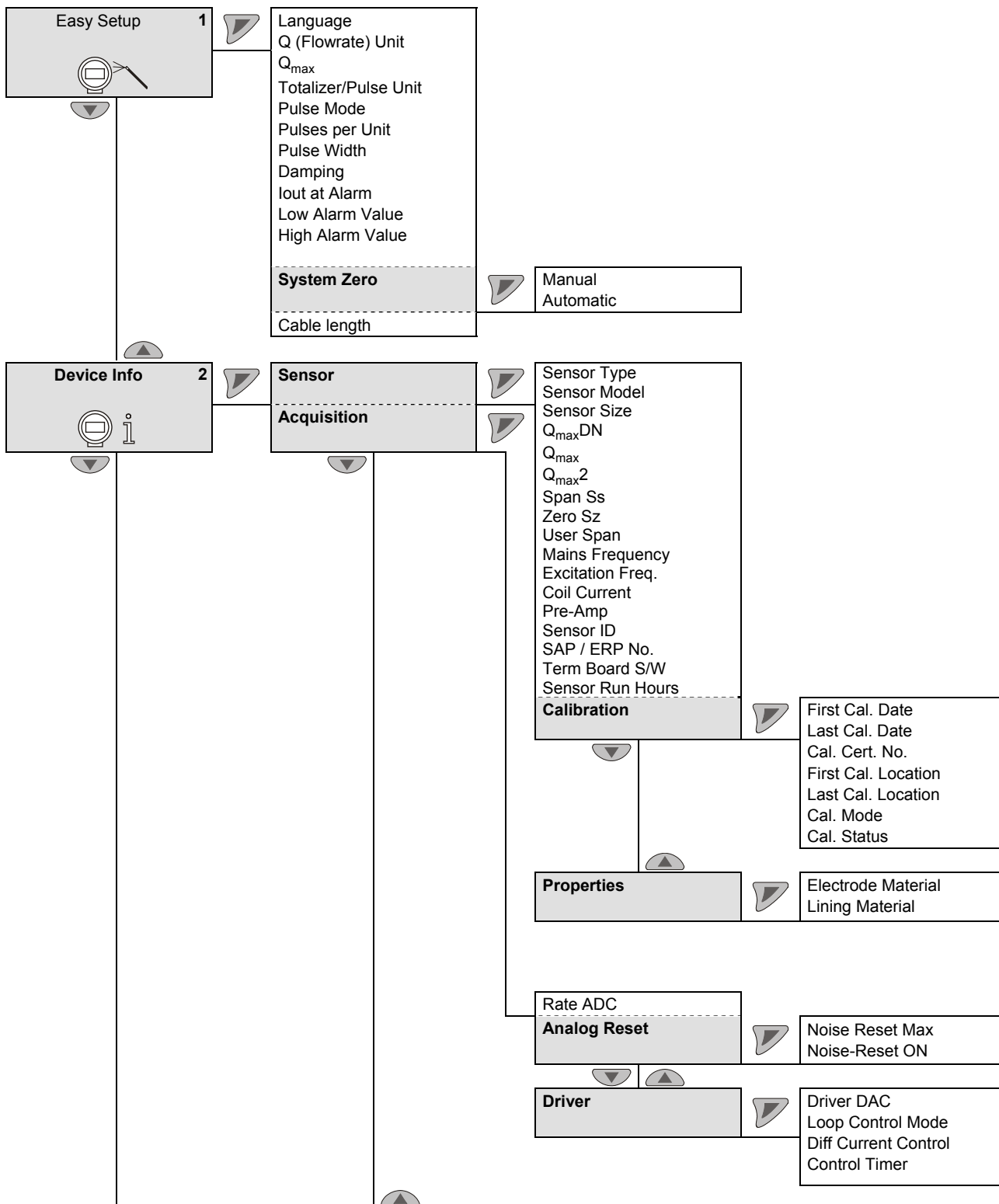

italics = Parameter can only be changed at the "advanced" password level.

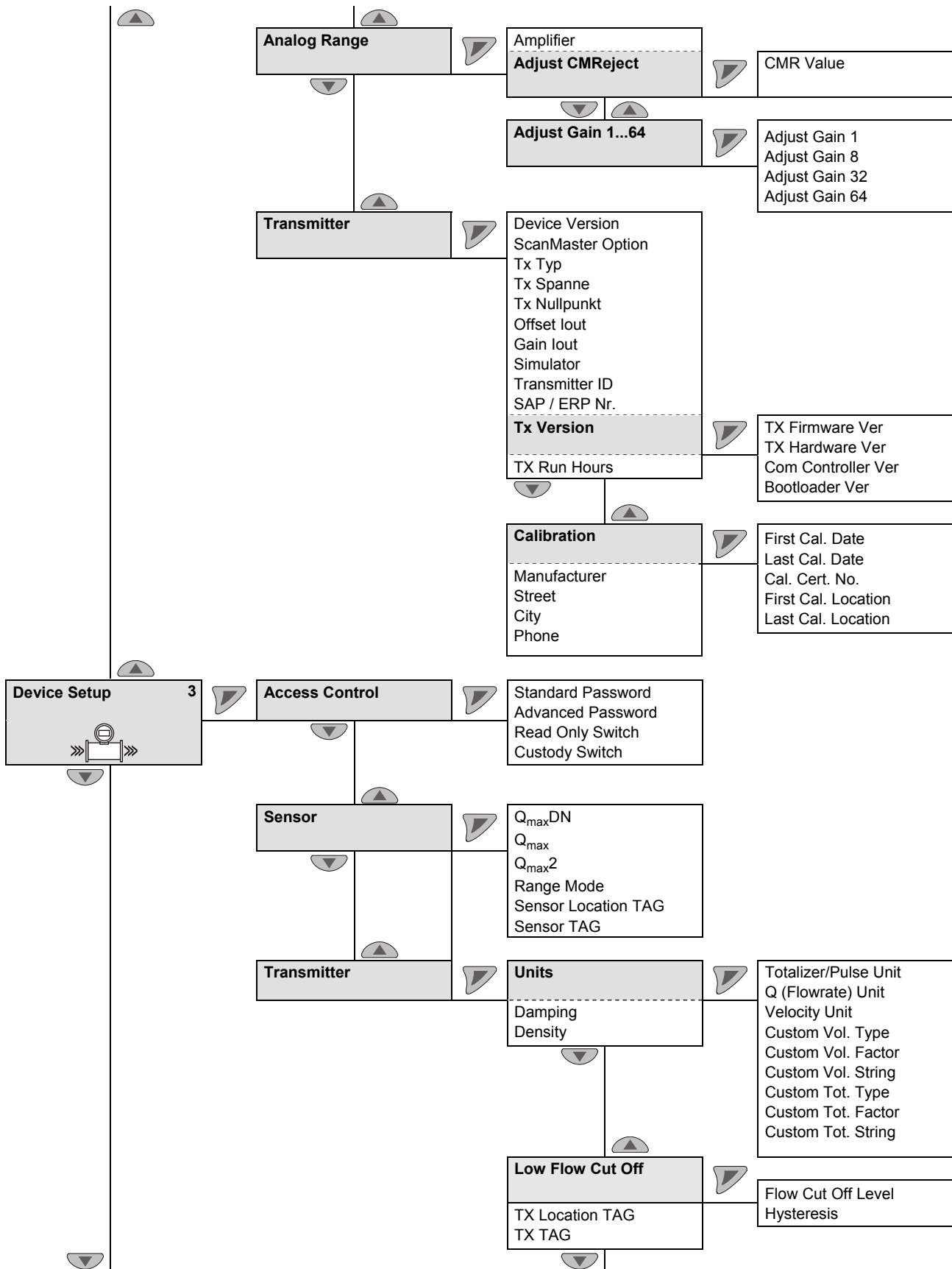

italics = Parameter can only be changed at the "advanced" password level.

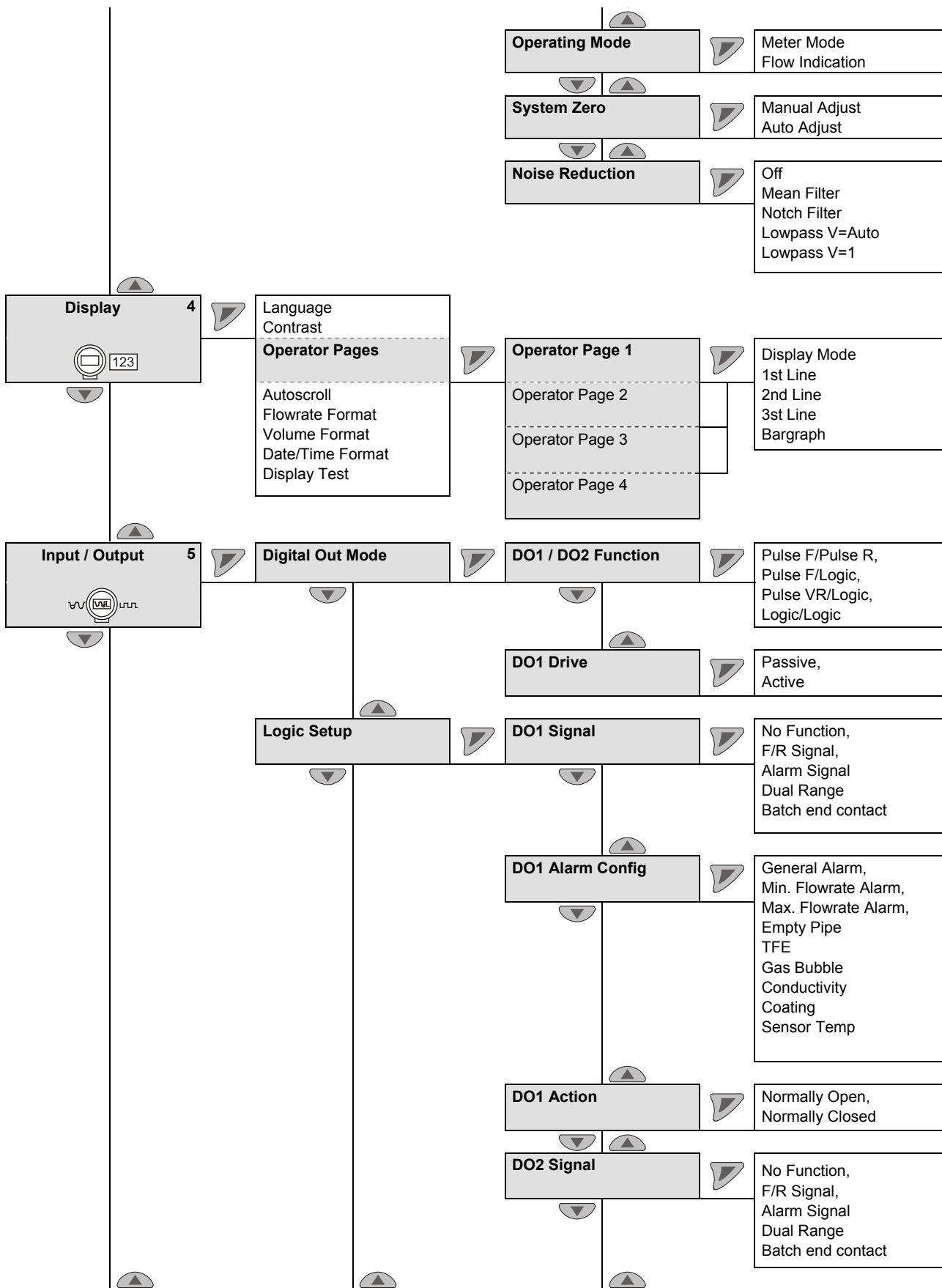

italics = Parameter can only be changed at the "advanced" password level.

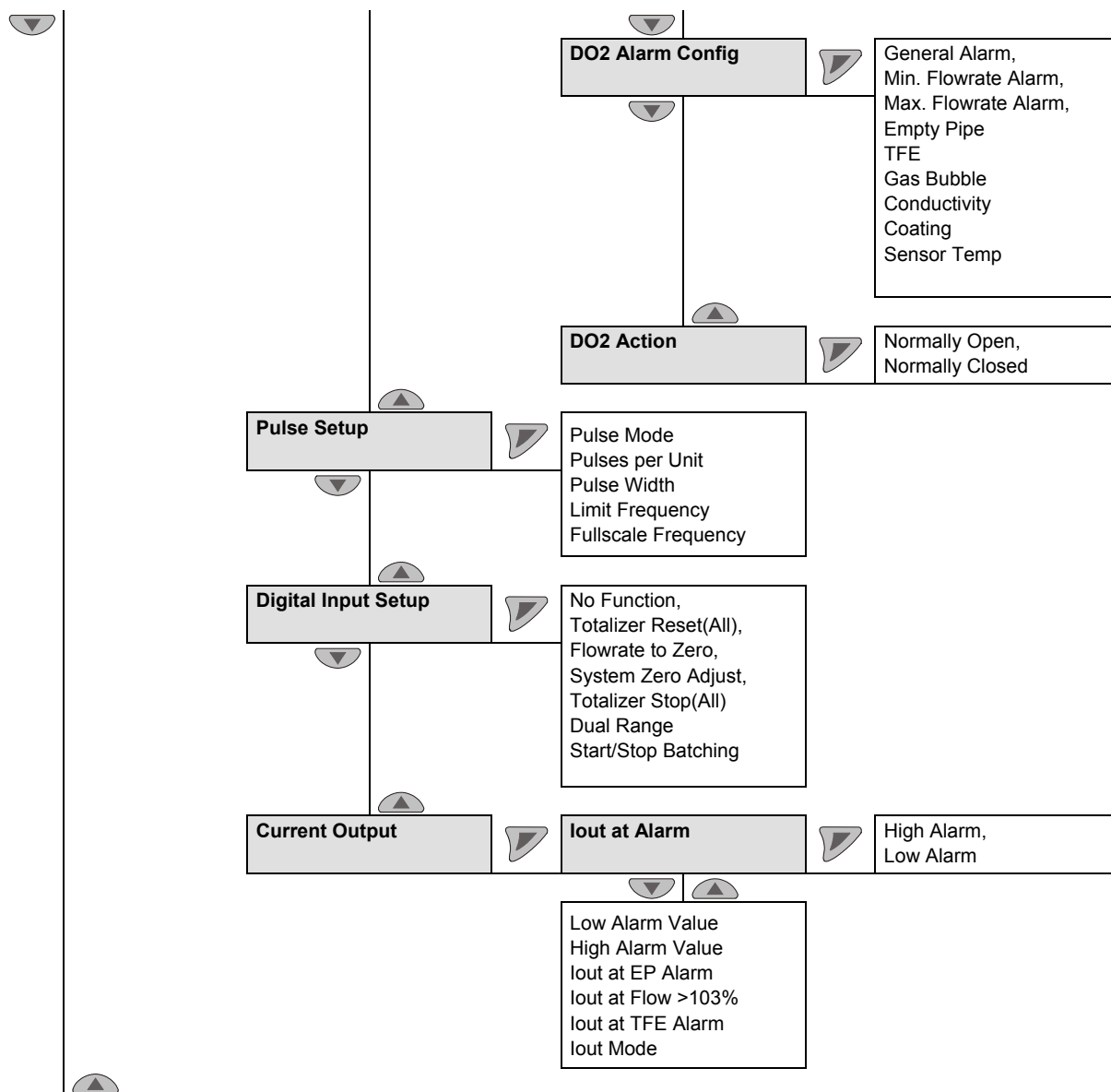

italics = Parameter can only be changed at the "advanced" password level.

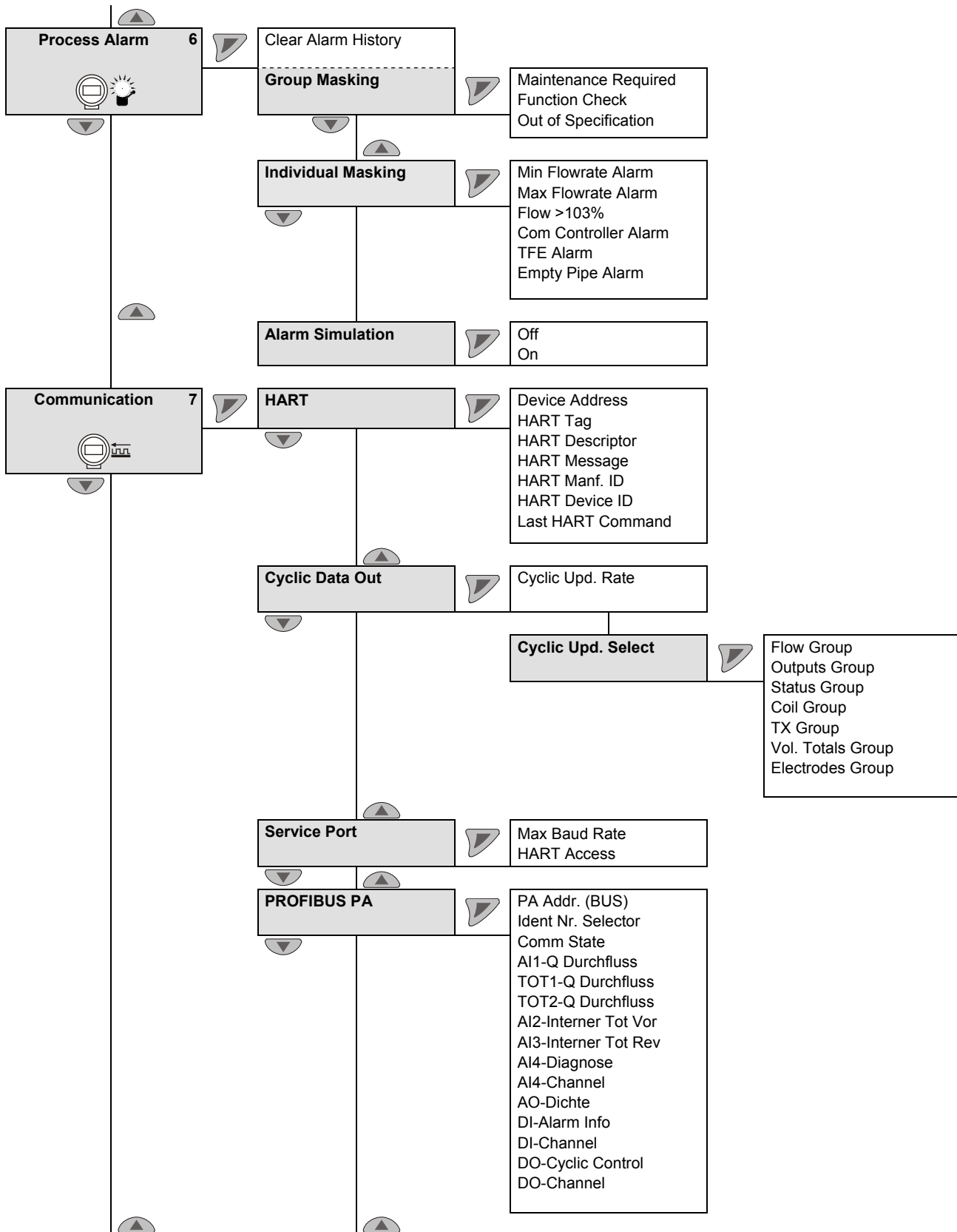

italics = Parameter can only be changed at the "advanced" password level.

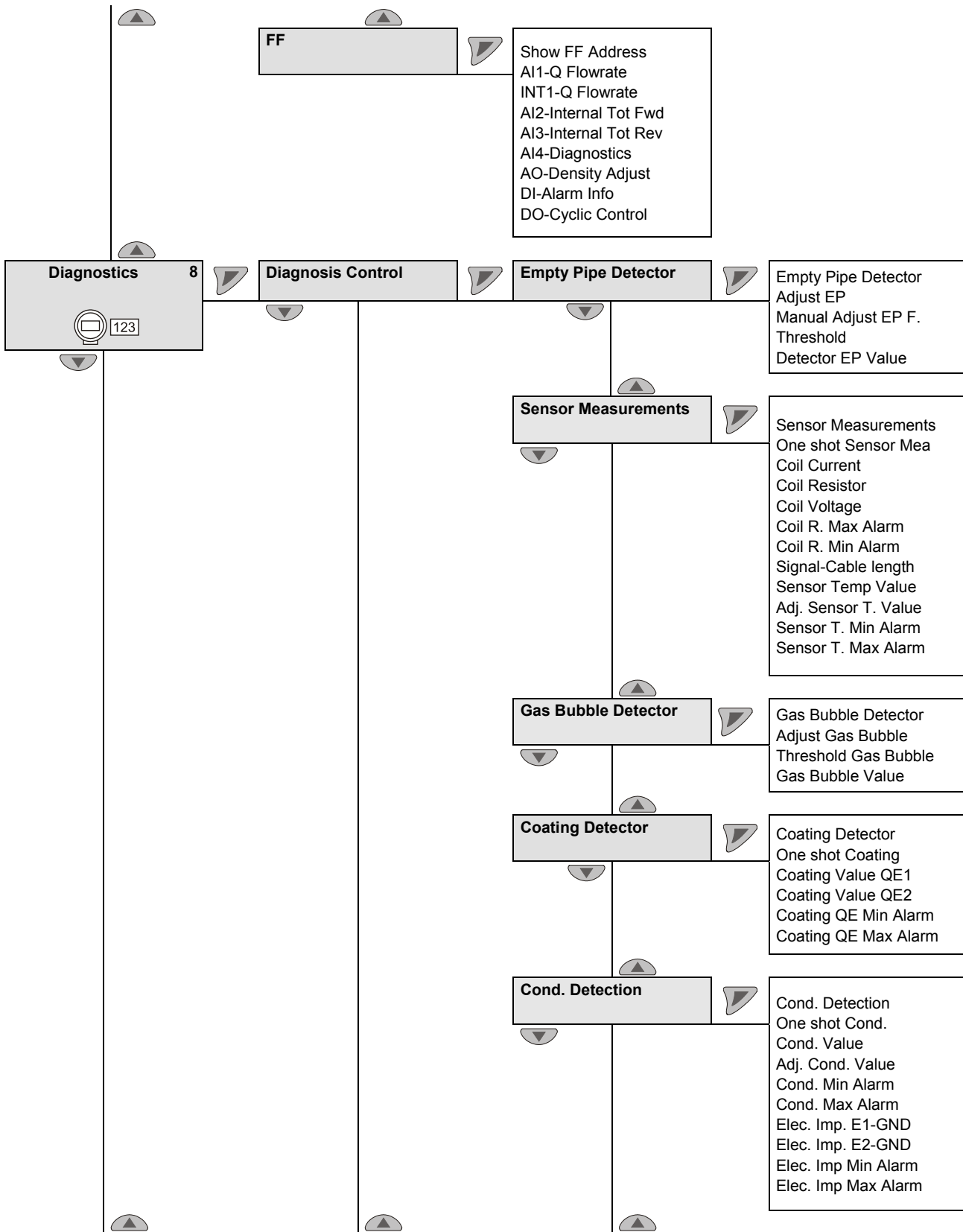

italics = Parameter can only be changed at the "advanced" password level.

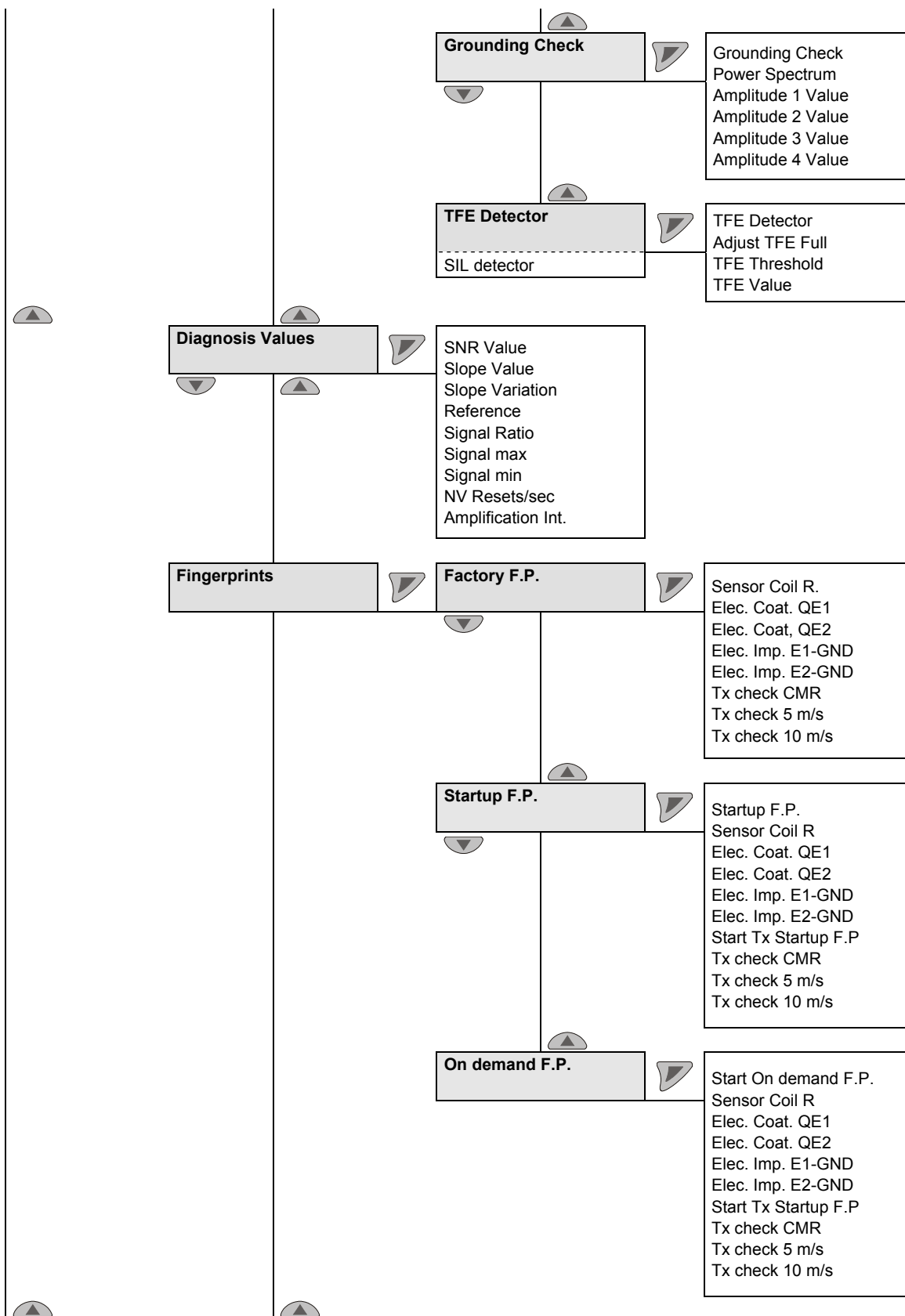

italics = Parameter can only be changed at the "advanced" password level.

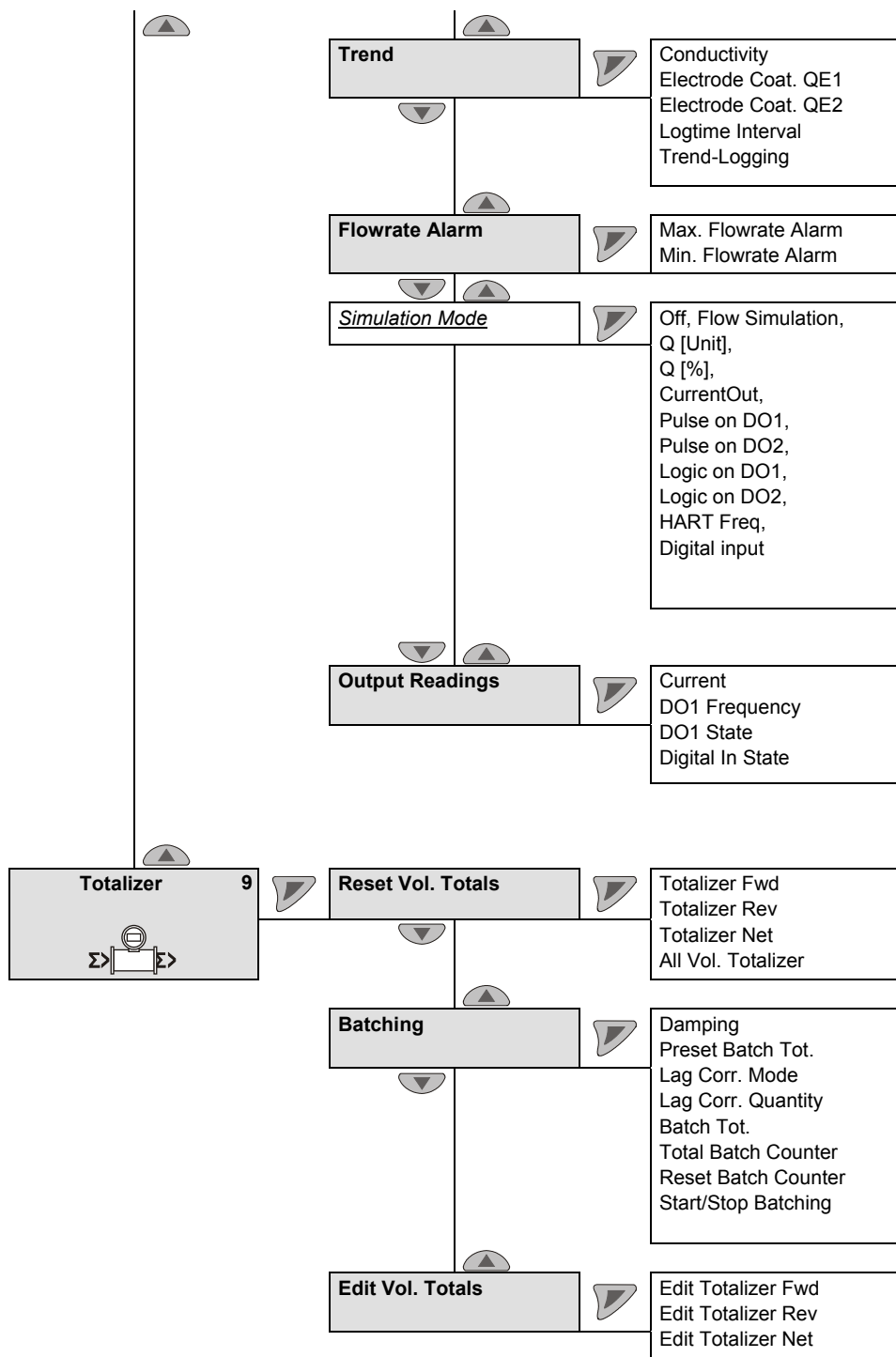

italics = Parameter can only be changed at the "advanced" password level.

8.4 Description of parameters
8.4.1 Menu: Easy Setup

Menu / Parameter	Value range	Description
Easy Setup		"Easy Setup" Menu
Language	Deutsch, English, Français, Español, Italiano, Dansk, Svenska, Polski, Russki, Zhongweng, Turkce	Select the menu language.
Q (Flowrate) Unit	l/s; l/min; l/h; ml/s; ml/min; m ³ /s; m ³ /min; m ³ /h; m ³ /d; Ml/d; ft ³ /s; ft ³ /min; ft ³ /h; ft ³ /d; ugal/s; ugal/min; ugal/h; ugal/d; Mugal/d; ical/s; ical/min; ical/h; ical/d; bls/s; bls/min; bls/h; bls/d; hl/h; g/s; g/min; g/h; kg/s; kg/min; kg/h; kg/d; t/min; t/h; t/d; lb/s; lb/min; lb/h; lb/d; custom/s	Select the unit for the flow indicator. Default setting: l/min
Q _{max}	Min. flow range: 0 ... 0.2 m/s (0 ... 0.02 x Q _{max} DN) Max. flow range: 0 ... 20 m/s (0 ... 2 x Q _{max} DN)	Select the flow range for forward and reverse flow. Default setting: 1 x Q _{max} DN.
Totalizer/Pulse Unit	m ³ ; l; ml; ft ³ ; hl; g; kg; t; lb; ical; ugal; bls; Ml; Mugal; custom	Select the unit for the flowmeters. Default setting: l
Operation	Pulse Mode, Fullscale Frequency	Select the operating mode for the digital output. There are two operating modes available: <ul style="list-style-type: none"> „Pulse Mode“: In pulse mode, pulses per unit are output (e.g., 1 pulse per m³). „Fullscale Frequency“: In frequency mode, a frequency proportional to the flowrate is output. The maximum frequency corresponding to the flow range end value is configurable (max. 5.25 kHz). Default setting: „Pulse Mode“
Pulses per Unit	-	Display of the pulses per unit output by the digital output. The max. possible number of pulses is 5250 per second.
Fullscale Frequency	0 ... 5250 Hz	Set the frequency for the flow range end value in Fullscale Frequency operating mode.



italics = Parameter can only be viewed at the "Advanced" password level.

1) Parameter / menu only available for FEP500 / FEH500.

Menu / Parameter	Value range	Description
Easy Setup (continued)		"Easy Setup" Menu
Pulse Width	0.1 ... 2000 ms	Select the pulse width for the digital output. The pulse factor and pulse width are interdependent and are calculated dynamically.
Damping	0.02 ... 60 s	Select the damping. The value set here relates to 1 T (Tau). The value refers to the response time for a step flowrate change. It affects the instantaneous value in the display and at the current output. Default setting: 1 second
Out at Alarm	Low, High	Status of the current output during an error. The "low" or "high" status is set in the subsequent menu. Default setting: "High".
Low Alarm Value	3.5 ... 3.6 mA	Current for Low Alarm. Default setting: 3.5 mA
High Alarm Value	21 ... 23 mA	Current for High Alarm. Default setting: 21.8 mA
System Zero		Select the "System Zero" submenu.

italics = Parameter can only be viewed at the "Advanced" password level.

1) Parameter / menu only available for FEP500 / FEH500.

Menu / Parameter	Value range	Description
Easy Setup (continued)		"Easy Setup" Menu
Cable length	0.01 ... 200 m	Enter the signal cable length between the transmitter and the flowmeter sensor. For devices with a compact design (FEP311, FEH311, FEP315, FEH315) 0.01 m must be entered.
		<p>i IMPORTANT (NOTE)</p> <p>The entry is required for FEP500, FEH500 if the diagnostic functions are to be used.</p> <p>When using the ScanMaster verification software you also have to enter the signal cable length.</p>
Easy Setup / System Zero		Submenu "System Zero"
Manual		Starts the manual zero adjustment.
Automatic		Starts the automatic zero adjustment.
		<p>i IMPORTANT (NOTE)</p> <p>Prior to starting the zero adjustment, make sure that:</p> <ul style="list-style-type: none"> • There is no flow through the flowmeter sensor (close all valves, shut-off devices, etc.) • The flowmeter sensor is completely filled with the fluid to be measured.

italics = Parameter can only be viewed at the "Advanced" password level.

1) Parameter / menu only available for FEP500 / FEH500.

8.4.2 Menu: Device Info



IMPORTANT (NOTE)

This menu is used only to display the device parameters. The parameters are displayed independently of the configured access level, but cannot be changed.

Menu / Parameter	Value range	Description
Device Info		
Sensor		Select the "Sensor" submenu.
Acquisition		Select the "Acquisition" submenu.
Analog Range		Select the "Analog Range" submenu.
Transmitter		Select the "Transmitter" submenu.

Device Info / Sensor		
Sensor Type	-	Type of flowmeter sensor (ProcessMaster 300 / 500, HygienicMaster 300 / 500). i IMPORTANT (NOTE) When commissioning the device, make sure that the transmitter is assigned to the sensor correctly. It is not possible to operate a flowmeter sensor of the 300 series with a transmitter of the 500 series.
Sensor Model	-	Indication of model number (e.g., FEP315)
Sensor Size	-	Size of sensor.
<i>Q_{maxDN}</i>	-	This value is the maximum flow at a velocity of 10 m/s. The value is set automatically via the selected flowmeter size.
Q _{max}	-	Set flow range end value for flow range 1. Factory setting: Flow range 1 activated.
Q _{max2}	-	Set flow range end value for flow range 2. Factory setting: Flow range 2 deactivated. i IMPORTANT (NOTE) The switchover between the two measuring ranges is done via the digital input or via the menu "Config. Device / Sensor / 2 flow ranges"
Span Ss	-	Calibration value for the sensor (span)
Zero Sz	-	Calibration value for the sensor (zero)

italics = Parameter can only be viewed at the "Advanced" password level.

1) Parameter / menu only available for FEP500 / FEH500.

Menu / Parameter	Value range	Description
Device Info / Sensor		
User Span		Indication of the correction value for the sensor span
Mains Frequency	-	Mains frequency for the supply power.
Excitation Freq.	-	Frequency used to operate the magnet coils of the flowmeter sensor.
Coil Current	-	Current used to operate the magnet coils of the flowmeter sensor.
Pre-Amp	-	Indication whether a preamplifier exists in the flowmeter sensor or not (Yes / No).
Sensor ID	-	ID number of the sensor.
SAP / ERP No.	-	Order number of the sensor.
Term Board S/W	-	Software version of the sensor memory integrated in the sensor.
Sensor Run Hours	-	Run hours of the flowmeter sensor.
Calibration		Select the "Calibration" submenu.
Properties		Select the "Properties" submenu.

Device Information / Sensor / Calibration		
First Cal. Date	-	Date of first calibration of sensor (calibration of new device).
Last Cal. Date	-	Date of last calibration of sensor.
Cal. Cert. No.	-	Identification (no.) of the relevant calibration certificate.
First Cal. Location	-	Place of first calibration of the sensor.
Last Cal. Location	-	Place of last calibration of sensor.
Cal. Mode	-	Calibration mode of the sensor.
Cal. Status	-	Calibration status of the sensor.

Device Info / Sensor / Properties		
Electrode Material	-	Electrode material of the sensor.
Lining Material	-	Liner material of the sensor.

italics = Parameter can only be viewed at the "Advanced" password level.

1) Parameter / menu only available for FEP500 / FEH500.

Menu / Parameter	Value range	Description
Device Info / Acquisition		
Rate ADC	-	Display for service purposes, only.
Analog Reset		Select the "Analog Reset" submenu.
Driver		Select the "Driver" submenu.

Device Info / Acquisition / Analog Reset		
Noise Reset Max	-	Display for service purposes, only.
Noise Reset On	-	

Device Info / Acquisition / Driver		
Driver DAC	-	Display for service purposes, only.
Loop Control Mode	-	
Diff Current Control	-	
Control Timer	-	



Device Info / Analog Range		
Amplifier	-	Display for service purposes, only.
Adjust CMReject		Select the "Adjust CMReject" submenu.
Adjust Gain 1 ... 64		Select the "Adjust Gain" submenu.

Device Info / Analog Range / Adjust CMReject		
CMR Value	-	Display for service purposes, only.

Device Info / Analog Range / Adjust Gain 1 ... 64		
Adjust Gain 1	-	Display for service purposes, only.
Adjust Gain 8		
Adjust Gain 16		
Adjust Gain 64		

italics = Parameter can only be viewed at the "Advanced" password level.

1) Parameter / menu only available for FEP500 / FEH500.

Menu / Parameter	Value range	Description
Device Info / Transmitter		
Device Version		Indication of the transmitter series (300 HART series, 300 PA series, 300 FF series, 500 HART series, 500 PA series, 500 FF series)
Scanmaster option		Indication whether the ScanMaster option is activated or not. For diagnostics or verification, the device can be checked with a separate tool (ScanMaster). This option is available for an extra charge and must be activated in the transmitter.
TX Type	-	Display the transmitter type.
TX Span	-	Calibration value for the transmitter (span)
TX Zero	-	Calibration value for the transmitter (zero)
Offset Iout		Indication of the adjustment value for the current output (zero).
Gain Iout		Indication of the adjustment value for the current output (span).
Simulator		Display for service purposes, only.
Transmitter ID	-	ID number of the transmitter.
SAP / ERP No.	-	Order number of the transmitter.
TX Version		Select the "TX Version" submenu.
<u>TX Run Hours</u>	-	Run hours of the transmitter.
Calibration		Select the "Calibration" submenu.
Manufacturer	-	Name of manufacturer
Street	-	Address of manufacturer (street).
City	-	Address (town) of manufacturer.
Phone	-	Phone number of manufacturer

Device Info / Transmitter / TX Version		
TX Firmware Ver.	-	Software version of the transmitter.
TX Hardware Ver.	-	Hardware version of the transmitter.
Com-Controller Ver.	-	Software version of the COM controller.
Bootloader Ver.	-	Software version of the bootloader.

Device Info / Transmitter / Calibration		
First Cal. Date	-	Date of first calibration for transmitter (calibration of new device).
Last Cal. Date	-	Date of last calibration of transmitter.
Cal. Cert. No.	-	Identification (no.) of the relevant calibration certificate.
First Cal. Location	-	Place of first calibration for the transmitter.
Last Cal. Location	-	Place of last calibration of transmitter.

italics = Parameter can only be viewed at the "Advanced" password level.

1) Parameter / menu only available for FEP500 / FEH500.

8.4.3 Menu: Device Setup

Menu / parameter	Value range	Description
Device Setup		
....Access Control		Select the "....Access Control" submenu.
....Sensor		Select the "....Sensor" submenu.
....Transmitter		Select the "....Transmitter" submenu.





Device Setup /Access Control		
Standard Password	Alphanumeric	Enter / change the password for the "Standard" access level.
Advanced Password	Alphanumeric	Enter / change the password for the "Advanced" access level.
Read Only Switch	Display only (ON / OFF)	Display of switch position of BR902 (hardware write protection). See Chapter 8.2.4 "Hardware write protection" on page 86.
Custody Switch	Display only (ON / OFF)	Display of the switch position of the calibration circuit breaker (must be activated for calibrated devices).

Device Setup /Sensor		
Q_{max}^{DN}	Read only	The displayed value is the flow rate at a flow velocity of 10 m/s. The value is determined automatically via the selected nominal diameter.
Q_{max}	Min. measuring range: 0 ... 0.2 m/s (0 ... 0.2 x Q_{max}^{DN}) Max. measuring range: 0 ... 20 m/s (0 ...2 x Q_{max}^{DN})	Select the upper range value measuring range 1) for forward and reverse flow. Default setting: 1 x Q_{max}^{DN} .
Q_{max}^2	See Q_{max}	Select the upper range value measuring range 2) for forward and reverse flow. Default setting: 1 x Q_{max}^{DN} , measuring range 2 is deactivated. i IMPORTANT (NOTE) The switchover between the two measuring ranges is performed via the digital input or via the menu "Device Setup /Sensor / Range Mode".

italics = Parameter can only be viewed at the "Advanced" password level.

1) Parameter / menu only available for FEP500 / FEH500.

Menu / parameter	Value range	Description
Device Setup /Sensor (continued)		
Range Mode	Q _{max} enabled Q _{max2} enabled	Manual switchover between flow ranges Q _{max} and Q _{max2} .
Sensor Location TAG	Alphanumeric, max. 20 characters	Enter the measuring point tag of the sensor (the measuring point tag is shown in the upper left-hand corner of the process display).
Sensor TAG	Alphanumeric, max. 20 characters	Enter the TAG number of the sensor.

Device Setup /Transmitter		
....Units		Select the "....Units" submenu.
Damping	0,02 ... 60 s	Set the damping (the value relates to 1 T (Tau). The value relates to a step flow rate change. It affects the instantaneous value in the display and at the current output. Default setting: 1 second
Density	0,01 ... 5,0 g/cm ³	If the flow is measured and indicated in the units g/s, g/min, g/h, kg/s, kg/min, kg/h, kg/d, t/min, t/h, t/d, lb/s, lb/min, lb/h and lb/d, a fixed density must be taken into account for the calculations. To convert the flow rate to mass flow units, a density value from 0.01 to 5.0 g/cm ³ can be entered.
....Low Flow Cut Off		Select the "....Low Flow Cut Off" submenu.
TX Location TAG	Alphanumeric, max. 20 characters	Enter the measuring point tag for the transmitter.
TX TAG	Alphanumeric, max. 20 characters	Enter the TAG number for the transmitter.
....Operating Mode		Select the "....Operating Mode" submenu.
....System Zero		Select the "....System Zero" submenu.
Noise Reduction	Off Mean Filter Notch Filter Lowpass V=Auto Lowpass V=1	Activates noise reduction in case of unstable flow signal. Activating noise reduction increases the response time. Factory setting: Off

italics = Parameter can only be viewed at the "Advanced" password level.

1) Parameter / menu only available for FEP500 / FEH500.

Menu / parameter	Value range	Description
Device Setup /Transmitter /Units		
Totalizer/Pulse Unit	m3, l, ml, ft3, hl, g, kg, t, lb, igoal, ugal, bls, MI, Mugal, customer-specific unit	Select the unit for the flowmeters. i IMPORTANT (NOTE) If a mass flow unit is selected, the corresponding density must be set in the "Device Setup /Transmitter / Density" menu.
Q (Flowrate) Unit	l/s, l/min, l/h, ml/s, ml/min, m3/s, m3/min, m3/h, m3/d, MI/d, ft3/s, ft3/min, ft3/h, ft3/d, ugal/s, ugal/min, ugal/h, ugal/d, Mugal/d, igoal/s, igoal/min, igoal/h, igoal/d, bls/s, bls/min, bls/h, bls/d, hl/h, g/s, g/min, g/h, kg/s, kg/min, kg/h, kg/d, t/min, t/h, t/d, lb/s, lb/min, lb/h, lb/d, customer-specific unit	Select the unit for the flow indicator. i IMPORTANT (NOTE) If a mass flow unit is selected, the corresponding density must be set in the "Device Setup /Transmitter / Density" menu.
Velocity Unit	m/s, m/min, cm/s, cm/min, feet/s, feet/min, inch/s, inch/min	Select the unit for the display of the flow velocity.
Custom Vol. Type	Volume flow Mass flow	Select whether the user-defined flow unit is displayed as a mass flow rate (with density) or volume flow rate (without density). i IMPORTANT (NOTE) If a mass flow unit is selected, the corresponding density must be set in the "Device Setup /Transmitter / Density" menu.
Custom Vol. Factor	0,0001 ... 100000 l/s	Enter the factor for a user-defined flow unit. The factor relates to the flow per liter.
Custom Vol. String	Alphanumeric, max. 20 characters	Enter the name for the user-defined flow unit.
Custom Tot. Type	Volume flow Mass flow	Select whether the user-defined totalizer unit is displayed as a mass flow rate (with density) or volume flow rate (without density). i IMPORTANT (NOTE) If a mass flow unit is selected, the corresponding density must be set in the "Device Setup /Transmitter / Density" menu.
Custom Tot. Factor	0,0001 ... 100000 l	Enter the factor for a user-defined totalizer unit. The factor relates to the flow per liter.
Custom Tot. String	Alphanumeric, max. 20 characters	Enter the name for the user-defined totalizer unit.

italics = Parameter can only be viewed at the "Advanced" password level.

1) Parameter / menu only available for FEP500 / FEH500.

Menu / parameter	Value range	Description
------------------	-------------	-------------

Device Setup /Transmitter /Low Flow Cut Off		
Threshold	0 ... 10 %	Select the switching threshold for leak flow volume monitoring. If the flow rate is below the switching threshold, there is no flow measurement. The current output is set to zero. The switching threshold for low flow monitoring is dependent on the currently set measuring range. Default setting: 1 %
Hysteresis	0 ... 50 %	Set the hysteresis for the leak flow volume.

Device Setup /Transmitter /Operating Mode		
Meter Mode	Forward only, Forward and Reverse	Setting of the measuring direction for the sensor. <ul style="list-style-type: none"> "Forward only": The device measures and counts in the forward direction only "Forward and Reverse": The device measures and counts in both directions Default setting: "Forward and Reverse"
Flow Indication	Normal, Reverse	Inverts the flow direction displayed. Default setting: "Normal"

Device Setup /Transmitter /System Zero		
Manual Adjust	-50 ... +50 mm/s	Enter the flow velocity for system zero.
Auto Adjust		Starts the automatic zero point balancing. i IMPORTANT (NOTE) Prior to starting the zero point balancing, make sure that: <ul style="list-style-type: none"> There is no flow through the sensor (close all valves, shut-off devices etc.) The sensor is completely filled with the medium to be measured

italics = Parameter can only be viewed at the "Advanced" password level.

1) Parameter / menu only available for FEP500 / FEH500.

8.4.4 Menu: Display

Menu / Parameter	Value range	Description
Display		
Language	Deutsch, English, Français, Español, Italiano, Dansk, Svenska, Polski, Ruski, Zhongweng, Turkce	Select the menu language.
Contrast	0 ... 100 %	Contrast setting for the LCD display
Operator Pages		Select the "Operator Pages" submenu. i IMPORTANT (NOTE) Up to four user-specific operator pages (layouts) can be configured for the process display. If several operator pages have been configured, these can be scrolled manually . In the factory setting only Operator Page 1 is enabled.
Autoscroll	On / Off	If Multiplex mode is enabled, you can also activate the "Autoscroll" function on the information level. In this function, operator pages appear on the LCD window in ten-second intervals. Manual scrolling through pre-configured operator pages as described above is no longer necessary. When Autoscroll mode is enabled, the icon is displayed on the lower left. Default setting: Off
<i>Flowrate Format</i>	x, x.x, x.xx, x.xxx, x.xxxx	Select the decimal places for the flow indicator. Default setting: x.xx
<i>Volume Format</i>	x, x.x, x.xx, x.xxx, x.xxxx	Select the decimal places for the flow totalizer. Factory setting: x.xx
Date/Time Format	DD-MM-YYYY, MM-DD-YYYY, YYYY-MM-DD	Set the display format for the date and time. Factory setting: YYYY-MM-DD
Display Test		Start the test of the LCD display with "OK".

Display / Operator Pages		
Operator Page 1		Select the "Operator Page 1" submenu.
Operator Page 2		Select the "Operator Page 2" submenu.
Operator Page 3		Select the "Operator Page 3" submenu.
Operator Page 4		Select the "Operator Page 4" submenu.

italics = Parameter can only be viewed at the "Advanced" password level.

1) Parameter / menu only available for FEP500 / FEH500.

Menu / Parameter	Value range	Description
Display / Operator Pages / Operator Page 1 (n)		
Display Mode	<ul style="list-style-type: none"> • 1 line with 6 characters. • 1 line with 6 characters + bar graph. • 1 line with 9 characters. • 1 line with 9 characters + bar graph. • 2 lines with 9 characters. • 2 lines with 9 characters + bar graph. • 3 lines with 9 characters (factory default). • Graphic (line recorder) • Off (the option disables the respective operator page) 	Configure each operator page. The following variants in the value range can be selected:
1st Line	<ul style="list-style-type: none"> • Flowrate [%] • Flowrate [Unit] • Totalizer Fwd • Totalizer Rev • Totalizer Net 	Select the value displayed in each line. The following variants in the value range can be selected:
2nd Line	<ul style="list-style-type: none"> • Flow Velocity [Unit] • Current Output [mA] • SignalProportion • Reference • Signal Max • Signal Min 	
3st Line	<ul style="list-style-type: none"> • Amplification • Noise Reset Counter • Total Batch Counter ¹ • Batch Totalizer ¹ • Conductivity ¹ • Sensor Temp ¹ 	
Bargraph	<ul style="list-style-type: none"> • Flowrate [%] • Current Output [mA] 	Select the value displayed in the bar graph. The measuring values in the value range can be selected.

italics = Parameter can only be viewed at the "Advanced" password level.

1) Parameter / menu only available for FEP500 / FEH500.

Parameterization

8.4.5 Menu: Input/Output

Menu / parameter	Value range	Description
Input/Output		
....Digital Out Mode		Select the "...Digital Out Mode" submenu.
....Logic Setup		Select the "...Logic Setup" submenu.
....Pulse Setup		Select the "...Pulse Setup" submenu.
Digital Input Setup	No Function, Totalizer Reset(All), Flowrate to Zero, System Zero Adjust, Totalizer Stop(All), Dual Range, Start/Stop Batching 1)	<p>Select the operating mode for the digital output. There are four operating modes available:</p> <ul style="list-style-type: none"> • Totalizer reset for all totalizers (forward, reverse and difference totalizer) • External switch-off • External zero point balancing • External totalizer stop for all totalizers (forward, reverse and difference totalizer) • Switchover between measuring ranges 1 and 2 (Q_{max} and Q_{max2}) • Start / stop of the fill function (batch) ¹⁾. <p>Default setting: external switch-off</p> <p>i IMPORTANT (NOTE) If the fill operation is stopped before the set fill quantity is reached, the fill totalizer is set to zero. When the fill function is restarted, the interrupted fill operation is not continued.</p>
Current		Select the "Current" submenu.

italics = Parameter can only be viewed at the "Advanced" password level.

1) Parameter / menu only available for FEP500 / FEH500.

Menu / parameter	Value range	Description
Input/Output / ...Digital Out Mode		
DO1/DO2 Function	Pulse F/Pulse R, Pulse F/Logic, Pulse FR/Logic, Logic/Logic	<p>Select the functions for the digital outputs DO1 and DO2.</p> <ul style="list-style-type: none"> • Pulse F/Pulse R: <ul style="list-style-type: none"> - DO1 = Pulse output for the forward direction. - DO2 = Pulse output for the reverse direction. • Pulse F/Logic: <ul style="list-style-type: none"> - DO1 = Pulse output for the forward direction. - DO2 = Binary output. • Pulse FR/Logic: <ul style="list-style-type: none"> - DO1 = Pulse output for the forward and reverse direction. - DO2 = Binary output. • Logic/Logic: <ul style="list-style-type: none"> - DO1 = Binary output. - DO2 = Binary output. <p>Default setting: pulse VR / binary.</p> <p>i IMPORTANT (NOTE) The function for the binary outputs is defined in the "...Logic Setup" menu.</p>
DO1 Drive	Passive, Active	<p>The digital output DO1 can be configured as an "active" or "passive" output. For information on the current configuration, refer to the order confirmation.</p> <p>Default setting: passive</p> <p>i IMPORTANT (NOTE) In the case of devices with a transmitter with single-compartment housing and devices for use in Zone 1, Div. 1, this parameter is disabled. In the case of devices with a transmitter with single-compartment housing, configuration is performed via jumpers on the transmitter backplane (refer to the "Commissioning" chapter).</p>

italics = Parameter can only be viewed at the "Advanced" password level.

1) Parameter / menu only available for FEP500 / FEH500.

Menu / parameter	Value range	Description
Input/Output / ...Logic Setup		
DO1 Signal	No Function, F/R Signal, Alarm Signal, Dual Range 1, Batch end contact 1	<p>The menu is displayed only if the binary / binary function is set in the "Function DO1 / DO2" menu. This menu is not displayed in the factory setting.</p> <ul style="list-style-type: none"> • F/R Signal: The digital output signals the flow direction. • Alarm Signal: The digital output functions as an alarm output. The alarm type is set in the "DO1 Alarm Config" menu. • Range Mode: The digital output is activated when measuring range 2 (Q_{max2}) is selected • Batch end contact: The digital output is activated when the set fill quantity is reached <p>Default setting: forward / reverse signal.</p>
.... DO1 Alarm Config		Select the ".... DO1 Alarm Config" submenu. The menu is displayed only if the "Alarm Signal" function is set in the "DO1 Signal" parameter.
DO1 Action	Normally Open, Normally Closed	Select the switching behavior for the digital output. Default setting: Normally Open.
DO2 Signal	No Function, F/R Signal, Alarm Signal, Dual Range 1, Batch end contact 1	Refer to the description "DO1 Signal".
.... DO2 Alarm Config		Select the ".... DO2 Alarm Config" submenu. The menu is displayed only if the "Alarm Signal" function is set in the "DO2 Signal" parameter.
DO2 Action	Normally Open, Normally Closed	Refer to the description "DO1 Action".

italics = Parameter can only be viewed at the "Advanced" password level.

1) Parameter / menu only available for FEP500 / FEH500.

Menu / parameter	Value range	Description
------------------	-------------	-------------

Input/Output / ...Logic Setup / DO1 Alarm Config		
General Alarm	ON / OFF	Each alarm can be activated separately. This allows for individual configuration when the digital output DO1 signals an alarm.
Min Flowrate Alarm	ON / OFF	
Max Flowrate Alarm	ON / OFF	
Empty Pipe Alarm	ON / OFF	
TFE	ON / OFF	
Gas Bubble 1)	ON / OFF	
Conductivity 1)	ON / OFF	
Sensor Temp 1)	ON / OFF	

Input/Output / ...Logic Setup / DO2 Alarm Config		
-	-	Refer to the description "... DO1 Alarm Config".

Input/Output /Pulse Setup		
Operating mode	Pulse Mode, Fullscale Frequency	The menu is displayed only if a pulse ... function has been selected under "Input/Output / ...Digital Out Mode / DO1/DO2 Function". Select the operating mode for the digital output. There are two operating modes available: <ul style="list-style-type: none"> In pulse mode, pulses per unit are output (e.g. 1 pulse per mPulse Mode³) "Fullscale Frequency": In frequency mode, a frequency proportional to the flow rate is output. The maximum frequency corresponding to the upper range value is configurable (max. 5 kHz). Default setting: "Pulse Mode"
Pulses per Unit	1 ... 5250/s	Set the pulses per unit in the "Pulse Mode" operating mode.
Pulse Width	0.1 ... 2000 ms	Set the pulse width in the "Pulse Mode" operating mode. The pulse factor and pulse width are interdependent and are calculated dynamically.
Limit Frequency	Read only	Display of the limiting frequency for the pulse output.
Fullscale Frequency	0 ... 5000 Hz	Set the frequency for the upper range value in "Fullscale Frequency" operating mode.

italics = Parameter can only be viewed at the "Advanced" password level.

1) Parameter / menu only available for FEP500 / FEH500.

Menu / parameter	Value range	Description
Input/Output / Current		
lout at Alarm	High Alarm, Low Alarm	Select the status of the current output in error condition. The output "low" or "high" current is set in the subsequent menu. Default setting: "High".
Low Alarm Value	3,5 ... 3,6 mA	Select the current for Low Alarm. Default setting: 3.5 mA.
High Alarm Value	21 ... 23 mA	Select the current for High Alarm. Factory setting: 21.8 mA.
lout at EP Alarm	Off, Q=0%, High Alarm, Low Alarm	Select the status of the current output for an empty meter tube. <ul style="list-style-type: none"> • Off: Error is not output at the current output. • Q = 0 %: The current output assumes the value for "No flow". • High Alarm: The current output assumes the value for "High Alarm". • Low Alarm: The current output assumes the value for "Low Alarm". Default setting: Off.
lout at Flow >103%	Off, High Alarm, Low Alarm	Select the status of the current output for overshoot of the upper range value. <ul style="list-style-type: none"> • Off: Error is not output at the current output. • High Alarm: The current output assumes the value for "High Alarm". • Low Alarm: The current output assumes the value for "Low Alarm". Default setting: Off.

italics = Parameter can only be viewed at the "Advanced" password level.

1) Parameter / menu only available for FEP500 / FEH500.



Menu / parameter	Value range	Description
Input/Output / Current (continued)		
Iout at TFE Alarm	Off, Q=0%, High Alarm, Low Alarm	Select the status that the current output shall assume in the case of a partial filling alarm. <ul style="list-style-type: none"> • Off: Error is not output at the current output. • Q = 0 %: The current output assumes the value for "No flow". • High Alarm: The current output assumes the value for "High Alarm". • Low Alarm: The current output assumes the value for "Low Alarm". Default setting: Off.
Iout Mode	4 ... 20 mA, 4 - 12 - 20 mA	Select the operating mode for the current output. <ul style="list-style-type: none"> • 4 ... 20 mA <ul style="list-style-type: none"> - 4 mA = No flow - 20 mA = Maximum flow • 4 - 12 - 20 mA <ul style="list-style-type: none"> - 4 mA = Maximum reverse flow - 12 mA = No flow - 20 mA = Maximum forward flow

italics = Parameter can only be viewed at the "Advanced" password level.

1) Parameter / menu only available for FEP500 / FEH500.

Parameterization

8.4.6 Menu: Process Alarm

Menu / Parameter	Value range	Description
Process Alarm		
Clear Alarm History	-	Allows you to clear the alarm list.
Group Masking		Select the "Group Masking" submenu.
Individual Masking		Select the "Individual Masking" submenu.
Alarm Simulation	Off, ...	A variety of alarm messages and output conditions can be simulated. For further information read and observe chapter "Alarm simulation".





Process Alarm / Group Masking		
Maintenance Required	On / Off	Alarm messages are divided into groups. If masking is activated for a group (On), no alarm occurs. For further information read and observe Chapter "Error conditions and alarms".
Function Check	On / Off	
Out of Specification	On / Off	

Process Alarm / Individual Masking		
Min Flowrate Alarm	On / Off	Individual alarm messages can also be masked. These are not included in the masking for the group. If masking is activated for an alarm (On), no alarm occurs. For further information read and observe chapter "Error conditions and alarms".
Max Flowrate Alarm	On / Off	
Flow >103%	On / Off	
Com Controller Alarm	On / Off	
TFE Alarm	On / Off	
Empty Pipe Alarm	On / Off	

italics = Parameter can only be viewed at the "Advanced" password level.

1) Parameter / menu only available for FEP500 / FEH500.

8.4.7 Menu: Communication

Menu / Parameter	Value range	Description
Communication		
HART		Select the "HART" submenu.
Cyclic Data Out		Select the "Cyclic Data Out" submenu.
Service Port		Select the "Service Port" submenu.
PROFIBUS		Select the "PROFIBUS" submenu. The menu is displayed only for devices with PROFIBUS PA.
FIELDBUS Foundation		Select the "FF" submenu. The menu is displayed only for devices with FOUNDATION Fieldbus.

Communication / HART		
<i>Device Address</i>	0 ... 15	Select the HART device address. The HART protocol has provisions for creating a bus with up to 15 devices (1 ... 15). i IMPORTANT (NOTE) If an address greater than 0 is set, the device operates in multidrop mode. The current output is fixed at 4 mA. Apart from that, the current output is only used for HART communication. Default setting: 0
HART TAG	8 characters, uppercase only, no special characters.	Enter a HART TAG number as unique identifier for the device.
HART Descriptor	16 characters, uppercase only, no special characters.	Enter a HART descriptor.
HART Message	Display only.	Display of the alphanumeric TAG number.
HART Manf. ID	Display only.	Display of the HART manufacturer ID. ABB = 26
HART Device ID	Display only.	Display of the HART device ID. FEX300 / FEX500 = 30
Last HART Command	Display only.	Display of the most recently sent HART command.

Communication / Cyclic Data Out		
Cyclic Upd. Rate	0,2 ... 3600 sec	Set the interval for data output via the infrared service port Default setting: 1 sec i IMPORTANT (NOTE) For detailed information about how to use the infrared service port refer to the separate operating instructions OI/FZA100.
Cyclic Upd. Select		Select the "Cyclic Upd. Select" submenu.

italics = Parameter can only be viewed at the "Advanced" password level.

1) Parameter / menu only available for FEP500 / FEH500.

Menu / Parameter	Value range	Description
Communication / Cyclic Data Out / Cyclic Upd. Select		
Flow Group	ON / OFF Contents: Q(%), Q(l/s), v(m/s)	Select the data to be output via the infrared service port. Diagnostic data is compiled in groups. Each group can be separately switched on or off, and thereby added to the diagnostic data set.
Outputs Group	ON / OFF Contents: 20mA output [Io(mA)], frequency at digital output DO1 [f1(Hz)], frequency at digital output DO2 [f2(Hz)]	
Status Group	ON / OFF Contents: Alarm, Empty Pipe Frequency [EPD (Hz)], TFE Frequency [TFE (Hz)]	
Coil Group	ON / OFF Contents: Coil current [Ic(mA)], Coil voltage [CV(V)], Total coil resistance [CR(Ohm)]	
TX Group	Contents: Reference voltage digits [Ref], Differential signal at ADC [SP], SignalMax [SM], SignalMin [Sm], SignalError from NR filter [SE], Signal DC errors [SDE], Internal amplification [Api], Signal to noise ratio SNR	
Vol. Totals Group	ON / OFF Contents: Forward totalizer [Fwd (m ³)], Reverse totalizer [Rev (m ³)], Differential totalizer [Net (m ³)]	
Electrodes Group	ON / OFF Contents: Electrode impedance E1 to ground [IE1 (kOhm)], Electrode impedance E2 to ground [IE2 (kOhm)], Deposit values of electrode 1 [QE1] and aE1, Electrode values of electrode 2 [QE2] and aE2, Gas bubble value [Gasb], Conductivity [conduS], Sensor temperature [sensorT°C]	

italics = Parameter can only be viewed at the "Advanced" password level.

1) Parameter / menu only available for FEP500 / FEH500.

Menu / Parameter	Value range	Description
Communication / Service Port		
Max Baud Rate	2400, 4800, 9600, 19200, 38400	Set the transmission rate (baud rate) for the infrared service port.
HART Access	On / Off	Activate / deactivate the infrared service port
Communication / PROFIBUS		
		The menu is displayed only for devices with PROFIBUS PA.
PA Addr. (-BUS-)	0 ... 126	<p>The "PROFIBUS" is displayed only if this option has been ordered for the device. Displays the slave address.</p> <p>Factory setting: 126</p> <p>Information about the DIP switches (transmitters with dual-compartment housing only):</p> <ul style="list-style-type: none"> • DIP switches 1 to 7 define the PROFIBUS address, • DIP switch 8 defines the address mode: • DIP switch 8 = Off = Addressing via bus or keypad using the menus for the device. The message "-BUS-" is displayed. • DIP switch 8 = On = Addressing via DIP switches 1-7; the message "(HW Switch)" is displayed. The address switch setting is only adopted when the device is restarted, not during running operation. <p>Factory setting for DIP switch 8: Off</p> <p>For further information read and observe chapter 7.3 "Start-up of PROFIBUS PA units".</p>
Ident Nr. Selector	0x9700, 0x9740, 0x3430	<p>Selection of the ID No. Selector. The parameter can be changed only when cyclic communication is stopped (Com State = OFF).</p> <p>Default setting: 0x3430</p>
Comm State	Offline, Operate, Clear, Stop	<p>Display of the communication status.</p> <ul style="list-style-type: none"> • Offline: BUS communication is deactivated. • Operate: Cyclic communication is running. • Clear: Device is being initialized. • Stop: Cyclic communication is stopped, BUS communication remains active.

italics = Parameter can only be viewed at the "Advanced" password level.

1) Parameter / menu only available for FEP500 / FEH500.

Menu / Parameter	Value range	Description
Communication / PROFIBUS (continued)		The menu is displayed only for devices with PROFIBUS PA.
AI1-Q Flowrate	Display only	Current flow in the selected unit from the Transducer Block Flow, including status.
TOT1-Q Flowrate	Display only	Current totalizer status in the selected unit from the Transducer Block Flow, including status.
TOT2-Q Flowrate	Display only	Current totalizer status in the selected unit from the Transducer Block Flow, including status.
AI2-Internal Tot Fwd	Display only	Current totalizer status of the forward totalizer in the selected unit from the Transducer Block Flow, including status.
AI3-Internal Tot Rev	Display only	Current totalizer status of the reverse totalizer in the selected unit from the Transducer Block Flow, including status.
AI4-Diagnostics	Display only	Current output value, including status. The channel can be selected using the "AI4 Channel" parameter. This function block delivers active values for FEX500 only. For this purpose, the sensor measurement or the conductivity measurement must be switched on. For FEX300 this function block delivers "0".
AI4-Channel	Sensor Temp, Conductivity	Selection of the channel output by AI4. The PV_SCALE and OUT_SCALE structure is not adapted. This channel is active for FEX500 only.
AO-Density Adjust	Display only	Current density output value from the Transducer Block Flow, including status.
DI-Alarm Info	Display only	Current output value, including status. The channel can be selected using the "DI Channel" parameter.
DI-Channel	Maintenance, Out of Spec, Function Check, Failure	Select the channel output by "DI Alarm Info".
DO-Cyclic Control	Display only	Current function, including status. The function can be selected using the "DO Channel" parameter.
DO-Channel	Off, Totalizer Reset(All), Flowrate to Zero, System Zero Adjust, Totalizer Stop(All), Dual Range, Start/Stop Batching	Select the function for "DO Cyclic Control".

italics = Parameter can only be viewed at the "Advanced" password level.

1) Parameter / menu only available for FEP500 / FEH500.

Menu / Parameter	Value range	Description
Communication / FF		The menu is displayed only for devices with FOUNDATION Fieldbus.
Show FF Address	Display only	Display of the FOUNDATION Fieldbus address. The address is set via the FOUNDATION Fieldbus Master.
AI1-Q Flowrate	Display only	Current flow in the selected unit from the Transducer Block Flow, including status.
INT1-Q Flowrate	Display only	Current output value, with status.
AI2-Internal Tot Fwd	Display only	Current totalizer status of the forward totalizer in the selected unit from the Transducer Block Flow, including status.
AI3-Internal Tot Rev	Display only	Current totalizer status of the reverse totalizer in the selected unit from the Transducer Block Flow, including status.
AI4-Diagnostics	Display only	Current output value, including status. The channel can be selected via the bus, only.
AO-Density Adjust	Display only	Current density output value from the Transducer Block Flow, including status.
DI-Alarm Info	Display only	Current output value, including status. The channel can be selected via the bus, only.
DO-Cyclic Control	Display only	Current function, including status. The channel can be selected via the bus, only.

italics = Parameter can only be viewed at the "Advanced" password level.

1) Parameter / menu only available for FEP500 / FEH500.

Parameterization

8.4.8 Menu: Diagnostics

Menu / Parameter	Value range	Description
Diagnostics		
Diagnosis Control		Select the "Diagnosis Control" submenu.
Diagnosis Values		Select the "Diagnosis Values" submenu.
Fingerprints		Select the "Fingerprints" submenu.
Trend		Select the "Trend" submenu.
Flowrate Alarm		Select the "Flowrate Alarm" submenu.
<i>Simulation Mode</i>	Off, Flow Velocity, Q [units], Q [%], Iout, Freq on DO1, Freq on DO2, Logic DO1, Logic DO2, HART Freq, Digital in	Manual simulation of measured values. The output values correspond to the simulated flowrate entered. The "Configuration" information is displayed in the lower line of the display. Restore the Simulation mode to "Off" once completed. The values in the "Value range" column can be simulated.
Output Readings		Select the "Output Readings" submenu.
Diagnostics / Diagnosis Control		
Empty Pipe Detector		Select the "Empty Pipe Detector" submenu.
Sensor Measurements		Select the "Sensor Measurements" submenu.
Gas Bubble Detector 1)		Select the "Gas Bubble Detector" submenu.
Coating Detector 1)		Select the "Coating Detector" submenu.
Cond. Detection 1)		Select the "Cond. Detection" submenu.
Grounding Check 1)		Select the "Grounding Check" submenu.
TFE Detector		Select the "TFE Detector" submenu.
Sil Detection		Select the "Sil Detection" submenu.

italics = Parameter can only be viewed at the "Advanced" password level.

1) Parameter / menu only available for FEP500 / FEH500.

Menu / Parameter	Value range	Description
Diagnostics / Diagnosis Control / Empty Pipe Detector		
Empty Pipe Detector	On / Off	Activate the "Empty Pipe Detector" function (only for sizes \geq DN 10 and without preamplifier). An entirely full measuring tube is essential for an accurate measurement. The "Empty Pipe Detector" function detects an empty measuring pipe. In the case of an alarm, the current output assumes the status that was defined in the "Input / Output / Current Output / Iout at EP Alarm" menu, and the pulse output is stopped. Default setting: Off
Adjust EP		The Empty Pipe Detector function must be adjusted according to the conditions on site. The switching threshold is set during the automatic adjustment. Start automatic adjustment of the Empty Pipe Detector function.
Manual Adjust EP F.	0 ... 255	Manually adjust the Empty Pipe Detector function. The value must be modified in such a way that the frequency for empty pipe detection (Detector EP Value) is close to 2000 Hz. i IMPORTANT (NOTE) Prior to starting the (manual / automatic) adjustment, make sure that: <ul style="list-style-type: none"> • There is no flow through the flowmeter sensor (close all valves, shut-off devices, etc.) • The flowmeter sensor is completely filled with the fluid to be measured.
Threshold	100 ... 60000 Hz	Set the switching threshold for empty pipe detection. The switching threshold is set automatically during automatic adjustment. The switching threshold can be changed in order to obtain manual fine adjustment.
Detector EP Value	Display only	Display of the frequency for empty pipe detection. If the current value exceeds the defined switching threshold, a message appears on the display and an alarm is output via the digital output, if configured accordingly.

italics = Parameter can only be viewed at the "Advanced" password level.

1) Parameter / menu only available for FEP500 / FEH500.

Menu / Parameter	Value range	Description
Diagnostics / Diagnosis Control / Sensor Measurements		
One shot Sensor Mea		Start the measurement. The measured values for the start moment are acquired.
Coil Current	Display only	Display the coil current.
Coil Resistor	Display only	Display the coil resistance.
Coil Voltage	Display only	Display the coil voltage.
Coil R. Max Alarm	0 ... 1000 Ω	Set the maximum limit value for the coil resistance. In the case of overshoot an alarm is tripped. Default setting: 1000 Ω
Coil R. Min Alarm	0 ... 1000 Ω	Set the minimum limit value for the coil resistance. In the case of undershoot an alarm is tripped. Default setting: 0 Ω
Signal-Cable length	0.01 ... 200 m	Enter the signal cable length between the transmitter and the flowmeter sensor. For devices with a compact design 0.01 m must be entered. Default setting: 0 m
Sensor Temp Value ¹⁾	Display only	Display the sensor temperature.
Adj. Sensor T. Value ¹⁾	-50 ... +200 °C	The sensor temperature must be adjusted according to the conditions on site. The temperature measured with a separate thermometer can be entered here.
Sensor T. Max Alarm ¹⁾	-50 ... +200 °C	Set the maximum limit value for the sensor temperature. In the case of overshoot an alarm is tripped. Default setting: +200 °C
Sensor T. Min Alarm ¹⁾	-50 ... +200 °C	Set the minimum limit value for the sensor temperature. In the case of undershoot an alarm is tripped. Default setting: -50 °C

italics = Parameter can only be viewed at the "Advanced" password level.

1) Parameter / menu only available for FEP500 / FEH500.

Menu / Parameter	Value range	Description
Diagnostics / Diagnosis Control / Gas Bubble Detector 1)		
Gas Bubble Detector	On / Off	Activate the "Gas Bubble Detector" function. Default setting: Off i IMPORTANT (NOTE) The gas bubble detector can be used in the nominal diameter range DN 10 ... 300. For further information read and observe chapter "Extended diagnostic functions".
Adjust Gas Bubble		The Gas Bubble Detector must be adjusted according to the conditions on site. Start automatic adjustment of the Gas Bubble Detector function. i IMPORTANT (NOTE) Prior to starting the adjustment, make sure that: <ul style="list-style-type: none"> • There is no flow through the flowmeter sensor (close all valves, shut-off devices, etc.) • The flowmeter sensor is completely filled with the fluid to be measured and free from gas bubbles.
Threshold Gas Bubble		Set the switching threshold. If the current value exceeds the defined switching threshold, a message appears on the display and an alarm is output via the digital output, if configured accordingly.
Gas Bubble Value	Display only	Display the current gas bubble value.

Diagnostics / Diagnosis Control / Coating Detector 1)		
Coating Detector	On / Off	Activate the "Electrode Deposit Detector" function. Default setting: Off i IMPORTANT (NOTE) The electrode deposit detector can be used in the nominal diameter range DN 10 ... 300. For further information read and observe chapter "Extended diagnostic functions".
One shot Coating		The electrode deposits are measured cyclically at defined intervals. Here, a current measurement can be started.
Coating Value QE1	Display only	Current deposit value for electrode 1
Coating Value QE2	Display only	Current deposit value for electrode 1

italics = Parameter can only be viewed at the "Advanced" password level.

1) Parameter / menu only available for FEP500 / FEH500.



Menu / Parameter	Value range	Description
Diagnostics / Diagnosis Control / Coating Detector (continued) ¹⁾		
Coating QE Min Alarm	0 ... 100.000	Set the minimum limit value for the electrode deposit detection. When the smaller value, QE1 or QE2, is undershot, an alarm is tripped. Default setting: 0
Coating QE Max Alarm	0 ... 100.000	Set the maximum limit value for the electrode deposit detection. When the greater value, QE1 or QE2, is overshoot, an alarm is tripped. Default setting: 100.000

Diagnostics / Diagnosis Control / Cond. Detection ¹⁾		
Cond. Detection	On / Off	Activate the "Cond. Detection" function. Default setting: Off i IMPORTANT (NOTE) The conductivity measurement function can be used in the nominal diameter range DN 10 ... 300. For further information read and observe chapter "Extended diagnostic functions".
One shot Cond.		The conductivity is measured cyclically at defined intervals. Here, a current measurement can be started.
Cond. Value		Display the conductivity.
Adj. Cond. Value	5 ... 20,000 µS/cm	The conductivity must be adjusted according to the fluid on site. The conductivity measured with a separate meter can be entered here.
Cond. Min Alarm	5 ... 20,000 µS/cm	Set the minimum limit value for the conductivity. In the case of undershoot an alarm is tripped. Default setting: 5 µS/cm
Cond. Max Alarm	5 ... 20,000 µS/cm	Set the maximum limit value for the conductivity. In the case of overshoot an alarm is tripped. Default setting: 20,000 µS/cm
Elec. Imp. E1-GND	Display only	Current impedance between electrode E1 and GND (ground potential).
Elec. Imp. E2-GND	Display only	Current impedance between electrode E2 and GND (ground potential).
Elec. Imp Min Alarm	0 ... 20,000 Ω	Set the minimum limit value for the impedance. In the case of undershoot an alarm is tripped. Default setting: 0 Ω
Elec. Imp Max Alarm	0 ... 20,000 Ω	Set the maximum limit value for the impedance. In the case of overshoot an alarm is tripped. Default setting: 20,000 Ω

italics = Parameter can only be viewed at the "Advanced" password level.

1) Parameter / menu only available for FEP500 / FEH500.

Menu / Parameter	Value range	Description
Diagnostics / Diagnosis Control / Grounding Check ¹⁾		
Grounding Check		Start the "Grounding Check" function.
Power Spectrum	Display only	Current power spectrum.
Amplitude 1 Value	Display only	Display the four highest amplitudes in the power spectrum.
Amplitude 2 Value	Display only	
Amplitude 3 Value	Display only	
Amplitude 4 Value	Display only	

Diagnostics / Diagnosis Control / TFE Detector		
TFE detector		<p>Activate the "Partial Filling Detector" (TFE) function.</p> <p>i IMPORTANT (NOTE) This function can be used only if the flowmeter sensor is provided with a measuring electrode for the detection of partially filled tubes (option). The flowmeter sensor must be installed horizontally, with the terminal box pointing upward. This function can be used for flowmeter sensors from size DN 50 without explosion protection or with explosion protection for Zone 2 / Div.2. For further information read and observe chapter 9 "Extended diagnostic functions".</p>
Adjust TFE Full		<p>The partial filling detector must be adjusted according to the conditions on site. Start automatic adjustment of the Partial Filling Detector function.</p> <p>i IMPORTANT (NOTE) Prior to starting the adjustment, make sure that:</p> <ul style="list-style-type: none"> • There is no flow through the flowmeter sensor (close all valves, shut-off devices, etc.) • The flowmeter sensor is completely filled with the fluid to be measured.
TFE Threshold		<p>Manual fine adjustment of the switching threshold. The switching threshold is automatically set during the automatic adjustment. If the current value exceeds the defined switching threshold, a message appears on the display and an alarm is output via the digital output, if configured accordingly.</p>
TFE Value		Display the current measuring value.

italics = Parameter can only be viewed at the "Advanced" password level.

1) Parameter / menu only available for FEP500 / FEH500.

Menu / Parameter	Value range	Description
Diagnostics / Diagnosis Control / Sil Detection		
SIL Detection	On / Off	By switching on the detector the monitoring of safety-relevant components is increased. With the detector switched on an SFF value of 91.6 is achieved for the FMEDA analysis (SIL2). With the detector switched off an SFF value of 85.5 is achieved for the FMEDA analysis (SIL1). This is valid for all devices with HART protocol. Default setting: Off

Diagnostics / Diagnosis Values		
SNR Value	Display only	Display the current diagnostic values for service purposes.
Slope Value		
Slope Variation		
Reference		
Signal Ratio (signal difference)		
Signal Max (Max.value of pos. signal)		
Signal Min (Max.value of neg. signal)		
Signal Error (signal error portion)		
NV Resets/sec		
Amplification Int.		

Diagnostics / Fingerprints ¹⁾		
Factory F.P.		Select the "Factory F.P." submenu.
Startup F.P.		Select the "Startup F.P." submenu.
On demand F.P.		Select the "On demand F.P." submenu.



italics = Parameter can only be viewed at the "Advanced" password level.



1) Parameter / menu only available for FEP500 / FEH500.

The "fingerprint" database integrated in the transmitter allows you to compare the values at the time of factory calibration or commissioning with the currently recorded values. As a result, changes of the measuring system can be detected early, and the appropriate measures can be taken.

Menu / Parameter	Value range	Description
------------------	-------------	-------------

Diagnostics / Fingerprints / Factory F.P. ¹⁾		
Sensor Coil R.	Display only	The factory fingerprint is created when the device are calibrated in the factory.
Elec. Coat. QE1		
Elec. Coat, QE2		
Elec. Imp. E1-GND		
Elec. Imp. E2-GND		
Tx check CMR		
Tx check 5 m/s		
Tx check 10 m/s		

Diagnostics / Fingerprints / Startup F.P. ¹⁾		
Startup F.P.		Create the commissioning fingerprint for the flowmeter sensor.
Sensor Coil R	Display only	The commissioning fingerprint is created on site during commissioning. The values measured for this fingerprint are indicated here.
Elec. Coat. QE1		
Elec. Coat, QE2		
Elec. Imp. E1-GND		
Elec. Imp. E2-GND		
Start Tx Startup F.P.		Create the commissioning fingerprint for the transmitter.
Tx check CMR	Display only	
Tx check 5 m/s		
Tx check 10 m/s		

Diagnostics / Fingerprints / On demand F.P. ¹⁾		
Start On demand F.P.		Creating the manual fingerprint.
Sensor Coil R	Display only	The manual fingerprint can be created at any time. The values measured for this fingerprint are indicated here.
Elec. Coat. QE1		
Elec. Coat, QE2		
Elec. Imp. E1-GND		
Elec. Imp. E2-GND		
Start Tx Startup F.P.		Create the manual fingerprint for the transmitter.
Tx check CMR		
Tx check 5 m/s		
Tx check 10 m/s		

italics = Parameter can only be viewed at the "Advanced" password level.

1) Parameter / menu only available for FEP500 / FEH500.

Menu / Parameter	Value range	Description
------------------	-------------	-------------

Diagnostics / Trend ¹⁾

Conductivity		The measured values are shown as a line diagram. When the "Trend-Logging" function is enabled, the measured values are stored at the defined interval (cycle time). The last 12 measured values are stored and indicated as a line diagram. The oldest data record is overwritten.
Electrode Coat. QE1		
Electrode Coat. QE2		
Logtime Interval	1 ... 45,000 min.	Interval for measured value logging.
Trend-Logging	ON / OFF	Activate the "Trend-Logging" function. When the "Trend-Logging" function is enabled, the measured values are stored at the defined interval (cycle time). The data records can be read out by the "ScanMaster" verification software and analyzed as trends.

Diagnostics / Flowrate Alarm

Max. Flowrate Alarm	0 ... 130 %	Set the maximum limit value for the flow.
Min. Flowrate Alarm	0 ... 130 %	Set the minimum limit value for the flow.



Diagnostics / Output Readings





Current	mA	Display the current values and statuses of the listed inputs and outputs.
DO1 Frequency	Hz	
DO2 State	open / closed	
Digital In State	open / closed	

italics = Parameter can only be viewed at the "Advanced" password level.

1) Parameter / menu only available for FEP500 / FEH500.

8.4.9 Menu: Totalizer

Menu / parameter	Value range	Description
Totalizer		
....Reset Vol. Totals		Select the "....Reset Vol. Totals" submenu.
....Batching 1)		Select the "....Batching" submenu.
....Edit Vol. Totals		Select the "....Edit Vol. Totals" submenu.

Totalizer /Reset Vol. Totals		
Edit Totalizer Fwd		Resets forward totalizer to zero.
Edit Totalizer Rev		Resets reverse totalizer to zero.
Edit Totalizer Net		Resets the difference totalizer to zero.
All Vol. Totalizer		Resets all totalizers to zero.

Totalizer /Batching ¹⁾		
Damping	ON / OFF	Switches the damping on / off. Default setting: ON
		i IMPORTANT (NOTE) In order to achieve a shorter response time for the fill function, the damping must be switched off. The fill time should be > 3 seconds.
Preset Batch Tot.	-	Setting of the fill quantity. When the defined fill quantity is reached, the configured digital output is activated.
Lag Corr. Mode	Automatic / Manual	Select the overrun correction. Closing the fill valve takes some time and as a consequence more liquid is added, even though the fill quantity is reached and the contact for closing the valve is actuated. With "Automatic overrun correction" the set fill quantity is corrected with the overrun quantity.
Lag Corr. Quantity	-100.000 ... 100.000	Manual entry of the overrun quantity.

italics = Parameter can only be viewed at the "Advanced" password level.

1) Parameter / menu only available for FEP500 / FEH500.

Menu / parameter	Value range	Description
Totalizer / ...Batching (continued) ¹⁾		
Batch Tot.	Read only	Once a fill operation has been started, the quantity already filled is shown here. The totalizer restarts at zero for each fill operation initiated and then counts up to the set fill quantity.
Total Batch Counter	Read only	Total number of fill operations.
Reset Batch Counter		Resets fill operation totalizer to zero.
Start/Stop Batching		Manual start / stop of the fill operation. Alternatively, the digital input can be configured for starting / stopping the fill operation.

Totalizer / totalizer default setting.		
Edit Totalizer Fwd	-	Enter totalizer statuses (e.g. when replacing the transmitter).
Edit Totalizer Rev	-	
Edit Totalizer Net	-	

italics = Parameter can only be viewed at the "Advanced" password level.

1) Parameter / menu only available for FEP500 / FEH500.

8.5 Alarm Simulation

In the "Process Alarm / Alarm Simulation" menu a variety of alarms can be simulated.

Parameter	Description
Process Alarm	
... / Alarm Simulation	
Off	Alarm Simulation switched off.
0-Sim.CurrentOut	Simulate current output
1-Sim.Logic on DO1	Switch on/off contact output (terminals 51, 52)
2-Sim.Pulse on DO1	Simulate pulse output (terminal 51/52)
3-Sim.Logic on DO2	Switch on/off contact output (terminals 41, 42)
4-Sim.Pulse on DO2	Simulate pulse output (terminal 51/52)
5-Min Alarm Flowrate	Simulate flowrate min. alarm
6-Max Alarm Flowrate	Simulate flowrate max. alarm
7-Flowrate >103%	Simulate flowrate > 103 % as alarm
8-Flow Simulation	Run flowrate simulation
9-Calbration Mode	Run transmitter alarm on simulator
10-Flowrate to Zero	Simulate external output switch-off
11-Totalizer Stop	Simulate external totalizer stop
12-Tot.Display<1600h	Simulate display value <1600 h for Q _{max} .
13-Totalizer Reset	Simulate external totalizer reset
14-Err.Sensor-Comms	Simulate distorted communication to SensorMemory.
15-HART Address <> 0	Simulate HART Multiplex mode
16-FRAM-Com Fail	Simulate FRAM error in the transmitter
17-No Sensor	Simulate error "No communication to SensorMemory"
18-Sim.Digital Input	Simulate digital input "ON/OFF"
19-ADC saturated	Simulate "AD converter override" error
20-Error Coil circ	Simulate error in coil loop
21-Coil Resistor	Simulate "Coil resistance out of limits" error
22-Driver Err Uref=0	Simulate "Reference voltage = 0" error
23-El.Noise too High	Simulate "Noise signal too high" error
24-DC to High	Simulate "DC too high, several NV resets" error
25-Empty Pipe	Simulate "Empty pipe" error
27-NV Corrupt	Simulate "NV Corrupt" error
29-Electrode Imp.	Simulate "Electrode impedance out of limits" error
30-Hold Last Value	Simulate "Hold last good value" error
32-Digi-Pot Error	Simulate "Digital potentiometer" error
33-TFE	Simulate "Partial filling alarm" error
34-CurrentOut Error	Simulate "Loop current output interrupted" error
35-Not Calibrated	Simulate "Not calibrated" error
36-SensorIncompatib.	Simulate "Calibration mode incompatible" error
37-ROM Error	Simulate ROM error in the transmitter
38-RAM Error	Simulate RAM error in the transmitter
39-Sim. HART Freq.	Simulate a HART frequency
40-SIL	Simulate "Self check alarm" error
41-Conductivity	Simulate "Conductivity alarm" error
42-Elec.Coated	Simulate "Electrode deposits" error
43-Gas bubble	Simulate "Gas bubbles" error
44-Pulse Cut Off	Simulate "Pulse output" error
46-Sensor Temp	Simulate "Sensor temperature alarm" error

8.6 FEP500 and FEH500 during fill operation

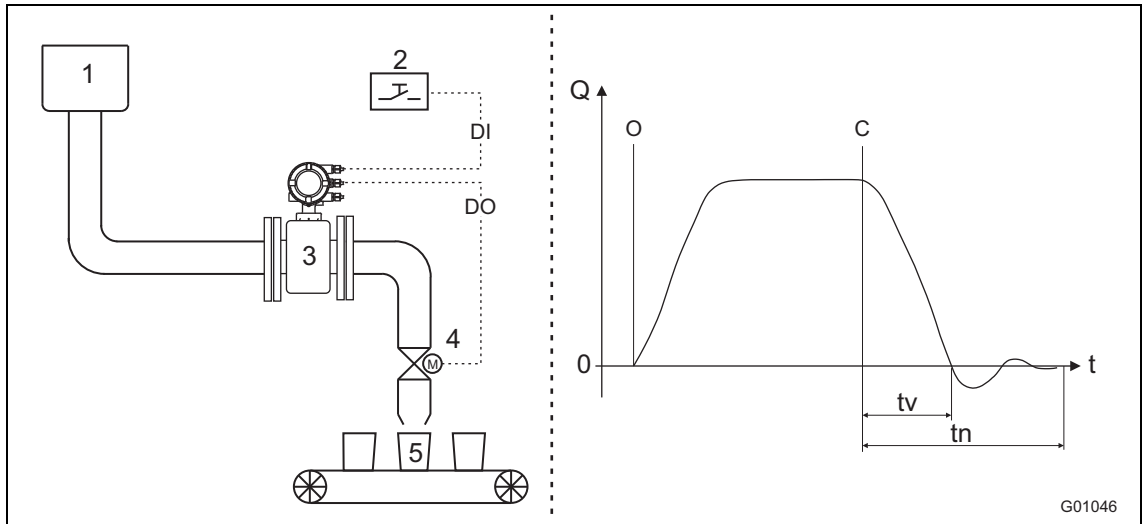

Fig. 67: Fill function (batch)

- 1 Supply tank
- 2 Start / stop contact (digital input)
- 3 Sensor
- 4 Motor valve
- 5 Tank to be filled
- DI Digital input
- DO Digital output
- O Valve open (filling started)
- C Valve closed (fill quantity reached)
- tv Valve closing time
- tn Overrun time

The integrated fill function (batch) of the ProcessMaster FEP500 and HygienicMaster FEH500 models allows you to control filling processes with a filling time >3 seconds.

During this process, the fill quantity is given via an adjustable totalizer.

The fill operation is started via the digital input (DI) or via the fieldbus.

The valve is triggered via one of the digital outputs (DO) and closed again once the preset fill quantity is reached.

The transmitter measures the overrun quantity (tn) and uses this value to calculate the overrun quantity correction value.

Additionally, the low flow cut-off can be activated if required.

8.6.1 Configuration

The fill function is configured via menus using the LCD indicator.

1. If the fill operation is to be controlled via the digital input (DI), the following settings must be applied in the "Input/Output" menu.

Menu / parameter	Selection	Description
Input/Output		
Digital Input Setup	Start/Stop Batching 1)	Select the operating mode for the digital output. <ul style="list-style-type: none"> • Start / stop of the fill function (batch) 1).

2. To control the fill valve, the following settings must be applied:

Menu / parameter	Selection	Description
Input/Output /Digital Out Mode		
DO1/DO2 Function	Logic/Logic	Select the functions for the digital outputs DO1 and DO2. <ul style="list-style-type: none"> • Logic/Logic: <ul style="list-style-type: none"> - DO1 = Binary output. - DO2 = Binary output.
Input/Output /Logic Setup		
DO1 Signal	Batch end contact 1	The menu is displayed only if the "Logic/Logic" function is set in the "DO1/DO2 Function" menu. This menu is not displayed in the factory setting. <ul style="list-style-type: none"> • Batch end contact: The digital output is activated when the set fill quantity is reached
DO2 Signal		

3. The parameters for the fill function must be configured.

Menu / parameter	Selection	Description
Totalizer /Batching ¹⁾		
Damping	Off	Switches the damping on / off. Default setting: ON IMPORTANT (NOTE) In order to achieve a shorter response time for the fill function, the damping must be switched off. The fill time should be > 3 seconds.
Preset Batch Tot.	-	Setting of the fill quantity. When the defined fill quantity is reached, the configured digital output is activated.
Lag Corr. Mode	Automatic / Manual	Select the overrun correction. Closing the fill valve takes some time and as a consequence more liquid is added, even though the fill quantity is reached and the contact for closing the valve is actuated. With "Automatic overrun correction" the set fill quantity is corrected with the overrun quantity.

Menu / parameter	Selection	Description
Totalizer /Batching ¹⁾		
Lag Corr. Quantity	-100.000 ... 100.000	Manual entry of the overrun quantity.
Batch Tot.	Read only	Once a fill operation has been started, the quantity already filled is shown here. The totalizer restarts at zero for each fill operation initiated and then counts up to the set fill quantity.
Total Batch Counter	Read only	Total number of fill operations.
Reset Batch Counter		Resets fill operation totalizer to zero.
Start/Stop Batching		Manual start / stop of the fill operation. Alternatively, the digital input can be configured for starting / stopping the fill operation.

4. To display all the data relevant to the fill operation in the process display, one of the operator pages in the **"Display"** menu must be configured accordingly.

Menu / parameter	Value range	Description
Display /Operator Pages /Operator Page 1 (n)		
Display Mode	3 lines with 9 characters	Configure each operator page.
1st Line	Flow rate [unit]	Select the measured value displayed in each line. The following variants in the value range can be selected:
2st Line	Number of fill operations	
3st Line	Batch totalizer	

8.7 Software – history
8.7.1 Devices with HART protocol

Software D200S062U01		
Software Version	Type of changes	Operating instruction
00.01.01	Original software	OI / FEP300 / FEH300, rev. A
00.01.02	Function extension, incorporated new HART commands	OI / FEP300 / FEH300, rev. A
00.02.00	Optimized measured value processing	OI / FEP300 / FEH300, rev. B
00.02.01	Optimized measured value processing	OI / FEP300 / FEH300, rev. B
00.02.04	Optimized boot sequence	OI / FEP300 / FEH300, rev. B
Software D200S069U01		
01.01.02	Optimized access to the service menu. Implemented TFE functionality. Added diagnostic functions and batch mode (for 500 series, only)	OI / FEX300 / FEX500, rev. C
01.01.04	Optimized sensitivity of the keys on the display	OI / FEX300 / FEX500, rev. D
01.01.06	Optimized view on the display	OI / FEX300 / FEX500, rev. D
01.02.00	Totalizer preset for ProcessMaster 300 implemented. Error with Swedish menu navigation corrected.	OI / FEX300 / FEX500, rev. E
01.02.01	TFE functionality optimized for integral mount design.	OI / FEX300 / FEX500, rev. F
01.03.01	Software optimized for ScanMaster verification tool.	OI / FEX300 / FEX500, rev. F

8.7.2 Devices with PROFIBUS PA or FOUNDATION fieldbus

Software D200S069U02 (PA)		Software D200S069U03 (FF)
Software Version	Type of changes	Operating instruction
00.01.02	Original software for PROFIBUS PA, FOUNDATION Fieldbus	OI / FEX300 / FEX500, rev. C
00.01.04	Optimized sensitivity of the keys on the display	OI / FEX300 / FEX500, rev. D
00.01.05	Optimized view on the display	OI / FEX300 / FEX500, rev. E
00.02.00	Totalizer preset for ProcessMaster 300 implemented.	OI / FEX300 / FEX500, rev. F

9 Extended diagnostic functions

9.1 General remarks



IMPORTANT (NOTE)

- The extended diagnostic functions are available for ProcessMaster 500 and HygienicMaster 500 only.
- The "Partial Filling Detector" function is **not** available for HygienicMaster 500.
- When using the extended diagnostic functions the external flowmeter sensor must not be provided with a preamplifier.
- To facilitate initial start-up, the extended diagnostic functions are deactivated (factory default).
- To use the extended diagnostic functions, a "start-up fingerprint" must be created during start-up of the flowmeter.
- Each diagnostic function (e.g. Gas Bubble Detector or Electrode Deposit Detector) can be individually activated. Once activated, the diagnostic function must be calibrated according to the conditions on site and the limit values must be set.

9.1.1 Detection of partial filling

Optionally, a measuring electrode (TFE electrode) is available for detecting a partially filled flowmeter sensor. The alarm for partial filling is output via the programmable digital output.

Conditions for using the function:

- Nominal diameter from DN 50 (2") with sensor design level B
- Max. signal cable length for version with external transmitter 200 m (656 ft).
- Conductivity of the measuring medium: 20 $\mu\text{S}/\text{cm}$... 20,000 $\mu\text{S}/\text{cm}$
- The function is only available for ProcessMaster 300 / 500 without explosion protection or with explosion protection for Zone 2 / Div. 2.

Additional installation conditions:

- The flowmeter sensor must be installed horizontally with the terminal box pointing upward.

9.1.2 Detection of gas bubbles

Gas bubbles in the fluid are detected by using an adjustable maximum limit value. When this limit value is exceeded, an alarm is tripped via the programmable digital output, depending on the configuration.

Conditions for using the function:

- This function is available in the nominal diameter range ¹⁾ of DN 10 ... 300 (3/8 " ... 12 ").
- The signal cable length of the remote transmitter must not exceed a maximum value of 50 m (164 ft) .
- For this function, the conductivity of the measuring medium must be in the range 20 $\mu\text{S}/\text{cm}$... 20,000 $\mu\text{S}/\text{cm}$.

Additional installation conditions:

- The flowmeter sensor can be installed either horizontally or vertically. Vertical installation is preferred.

1) The specified nominal diameter range is valid for ProcessMaster, only. The nominal diameter range valid for HygienicMaster is DN 10 ... 100 (3/8 " ... 4 ").

9.1.3 Electrode coating detection

This function provides the opportunity to detect coatings on the measuring electrodes by using an adjustable maximum limit value.

When the set limit value is exceeded, an alarm is tripped via the programmable digital output, depending on the configuration.

Conditions for using the function:

- This function is available in the nominal diameter range ²⁾ of DN 10 ... 300 (3/8 " ... 12 ").
- The signal cable length of the remote transmitter must not exceed a maximum value of 50 m (164 ft) .
- For this function, the conductivity of the measuring medium must be in the range 20 µS/cm ... 20,000 µS/cm.

Additional installation conditions:

- When using plastic tubes, install a grounding plate at the front and back of the device.

9.1.4 Conductivity monitoring

The conductivity of the fluid is monitored by using an adjustable minimum / maximum limit value.

When the value falls below or exceeds the set limit value, an alarm is tripped via the programmable digital output, depending on the configuration.

Conditions for using the function:

- This function is available in the nominal diameter range ¹⁾ of DN 10 ... 300 (3/8 " ... 12 ").
- The signal cable length of the remote transmitter must not exceed a maximum value of 50 m (164 ft) .
- For this function, the conductivity of the measuring medium must be in the range 20 µS/cm ... 20,000 µS/cm.

Additional installation conditions:

- When using plastic tubes, install a grounding plate at the front and back of the device.
- There must not be any deposits on the measuring electrodes.

1) The specified nominal diameter range is valid for ProcessMaster, only. The nominal diameter range valid for HygienicMaster is DN 10 ... 100 (3/8 " ... 4 ").

9.1.5 Electrode impedance monitoring

The impedance between the electrode and ground is monitored by using a minimum / maximum limit value. This enables the transmitter to detect an electrode fine short or leakage.

When the value falls below or exceeds the set limit value, an alarm is tripped via the programmable digital output, depending on the configuration.

Conditions for using the function:

- This function is available in the nominal diameter range ¹⁾ of DN 10 ... 300 (3/8 " ... 12 ").
- The signal cable length of the remote transmitter must not exceed a maximum value of 50 m (164 ft) .
- For this function, the conductivity of the measuring medium must be in the range 20 µS/cm ... 20,000 µS/cm.

Additional installation conditions:

- When using plastic tubes, install a grounding plate at the front and back of the device.
- There must not be any deposits on the measuring electrodes.
- The measuring tube must always be completely full, and the fluid must feature only minor conductivity variations.

9.1.6 Sensor measurements

This function includes the monitoring of the sensor temperature and the monitoring of the resistance of the flowmeter sensor's coils.

9.1.6.1 Sensor temperature monitoring

The temperature of the coils in the flowmeter sensor can be monitored by using adjustable minimum / maximum limit values. When a set limit value is exceeded, an alarm is tripped via the programmable digital output, depending on the configuration.

The coil temperature is a factor of the ambient and fluid temperatures. The measurement can, e.g., be used to monitor overtemperature due to the fluid. The coil temperature is measured indirectly via the coil DC resistance.

9.1.6.2 Monitoring of the sensor coil resistance

The coils in the flowmeter sensor can be monitored by using adjustable minimum / maximum limit values for the coil resistance. When a set limit value is exceeded, an alarm is tripped via the programmable digital output, depending on the configuration.

- 1) The specified nominal diameter range is valid for ProcessMaster, only. The nominal diameter range valid for HygienicMaster is DN 10 ... 100 (3/8 " ... 4 ").

9.1.7 Trend

The device has an internal memory where the measured value for the electrode deposits and the conductivity are cyclically stored as a data set with an adjustable time (1 min ... 45000 min). A maximum of 12 data sets is stored. When the thirteenth record is stored, the oldest data set is overwritten automatically.

The data sets can be read out or analyzed as a trend using the external diagnostic tool (ScanMaster).

9.1.8 Fingerprint

The "fingerprint" database integrated in the transmitter allows you to compare the values at the time of factory calibration or commissioning with the currently recorded values.

9.1.9 Checking the grounding

This function allows you to check the electrical grounding of the device. While the check is in progress, no flow measurement can take place.

Conditions for using the function:

- The measuring tube must be completely full.
- No flow must occur in the flowmeter sensor.

Additional installation conditions:

- The flowmeter sensor must not be provided with a preamplifier.

9.2 Performing the earthing check

... / Diagnostics / ...Diagnosis Control /Grounding Check ¹⁾		
Grounding Check		Start the "Grounding Check" function.
Power Spectrum	Read only	Current power spectrum.
Amplitude 1 Value	Read only	Display the four highest amplitudes in the power spectrum.
Amplitude 2 Value	Read only	
Amplitude 3 Value	Read only	
Amplitude 4 Value	Read only	

italics = Parameter can only be viewed at the "Advanced" password level.

1) Parameter / menu only available for FEP500 / FEH500.

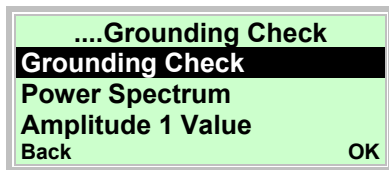

5. Use or to select the "Grounding Check" entry.

6. Use to start the "Grounding Check" function.

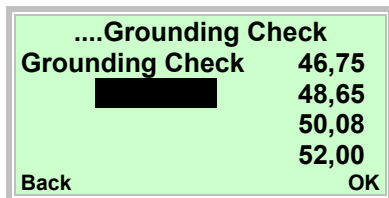

Once the earthing check has been started, the frequency range up to 250 Hz is measured. The four most intensive frequencies of the spectrum are shown at the right of the display.

The corresponding amplitudes and the power spectrum over the frequency range can be called up for display using the following parameters.



7. Use or to select the "Power Spectrum" entry.

8. Use to display the parameter.

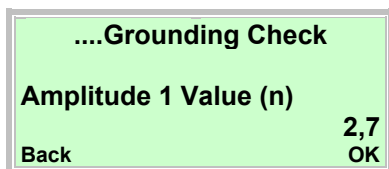

9. Use or to select the "Amplitude 1 Value (n)" entry.

10. Use to display the parameter.

The measured values indicate possible disturbances to the earthing line of the device at the time of the test.

No or minor disturbance:

- When the power spectrum is below 1000
- When the four measured amplitude values are above 10

Check the device earthing (!):

- When the power spectrum is above 1000
- When the four measured amplitude values are above 10

9.3 Recommended settings for diagnostic limit values

In the "Diagnostics / Diagnosis Control / ..." menu, limit values for the diagnostic values can be specified.

In order to simplify their setting, recommendations for the individual limit values are shown here.

The values indicated are only intended as a rough guide and may need to be adapted in line with on-site conditions.

9.3.1 Limit values for the coil resistance

Coil resistance monitoring is switched off (factory default).

Monitoring can be switched on in the "**Diagnostics / Diagnosis Control / Sensor Measurements**" menu.

Parameter	Factory setting
Coil R. Min Alarm	0 ohms
Coil R. Max Alarm	1000 ohms

The coil resistance depends on the measuring medium temperature T_{medium} and the ambient temperature.

T_{medium}	Parameter	
	R coil min alarm	R coil max alarm
-40 °C (-40 °F)	Factory for Fingerprint (coil resistance) x 0.71	Factory for Fingerprint (coil resistance) x 0.79
-20 °C (-4 °F)	Factory for Fingerprint (coil resistance) x 0.81	Factory for Fingerprint (coil resistance) x 0.89
0 °C (32 °F)	Factory for Fingerprint (coil resistance) x 0.9	Factory for Fingerprint (coil resistance) x 1.0
20 °C (68 °F)	Factory for Fingerprint (coil resistance) x 0.95	Factory for Fingerprint (coil resistance) x 1.05
60 °C (140 °F)	Factory for Fingerprint (coil resistance) x 1.19	Factory for Fingerprint (coil resistance) x 1.31
90 °C (194 °F)	Factory for Fingerprint (coil resistance) x 1.28	Factory for Fingerprint (coil resistance) x 1.42
130 °C (266 °F)	Factory for Fingerprint (coil resistance) x 1.43	Factory for Fingerprint (coil resistance) x 1.58
180 °C (356 °F)	Factory for Fingerprint (coil resistance) x 1.62	Factory for Fingerprint (coil resistance) x 1.79

9.3.2 Limit values for the electrode deposits

Electrode deposit monitoring is switched off (factory default). Monitoring can be switched on in the **"Diagnostics / Diagnosis Control / Coating Detector"** menu.

Parameter	Factory setting
Coating QE Min Alarm	0 ohms
Coating QE Max Alarm	100.000 ohms

Recommended settings in the "Diagnostics / Diagnosis Control / Coating Detector" menu

- Coating QE Min Alarm = 0.5 x coating value QE
- Coating QE Max Alarm = 2.0 x coating value QE



IMPORTANT (NOTE)

The deposit value QE is the mean value of Startup Fingerprint QE1 and QE2. The value is determined using the following formula:

$$QE = (\text{Startup Fingerprint QE1} + \text{Startup Fingerprint QE2}) / 2$$

9.3.3 Limit values for the electrode impedance

Electrode impedance monitoring is switched off (factory default). Monitoring can be switched on in the **"Diagnostics / Diagnosis Control / Cond. Detection"** menu.

Parameter	Factory setting
Elec.Imp.Min Alarm	0 ohms
Elec.Imp.Max Alarm	20.000 ohms

The limit values for parameters **"Elec.Imp.Min Alarm"** and **"Elec.Imp.Max Alarm"** depend on the measuring media conductivity and must be determined on site.

Recommended settings

- Elec.Imp.Min Alarm = 0.2 x average impedance value
- Elec.Imp.Max Alarm = 3.0 x average impedance value



IMPORTANT (NOTE)

The average impedance value is the value of Startup Fingerprint "Elec. Imp. E1-GND" and "Elec. Imp. E2-GND". The value is determined using the following formula:

$$\text{Average impedance value} = (\text{Startup Fingerprint "Elec. Imp. E1-GND"} + \text{Startup Fingerprint "Elec. Imp. E2-GND"}) / 2$$

9.3.4 Recommended settings for the Trend Logger

"Diagnostics / Trend" menu

- Logtime Interval = 43,200 minutes

10 Error messages

10.1 Invoking the error description

Additional details about the error that has occurred can be called up on the information level.

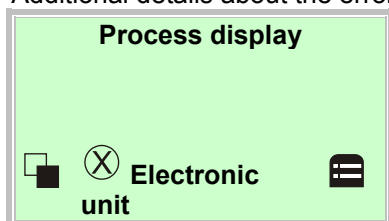

1. Use to go to the information level.

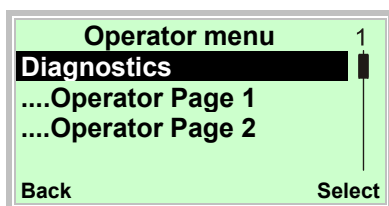

2. Use or select the submenu "Diagnostics".

3. Confirm the selection with .

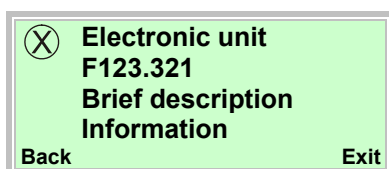

The first line shows the area in which the error has occurred.

The second line shows the unique error number.

The next lines show a brief description of the error and information on how to remedy it.

10.2 Error states and alarms
10.2.1 Errors

Error no. / Range	Text on the LCD display	Cause	Remedy
F254.038 Electronics unit	RAM Error in Transmitter Contact ABB Service	Error in the transmitter electronics unit.	Replace the electronics unit or contact ABB Service.
F253.037 Electronics unit	ROM Error in Transmitter Contact ABB Service	Error in the transmitter electronics unit.	Replace the electronics unit or contact ABB Service.
F252.017 Sensor	No Sensor Memory Check wiring Check switch SW3	Incorrectly wired terminals D1 and D2. Short circuit or break in wires for D1, D2. Jumper SW3 is not correctly plugged into the backplane. Old flowmeter sensor connected without SensorMemory.	Check the wiring for terminals D1, D2. If an old flowmeter sensor (e.g., model DE41F) is connected without SensorMemory, plug the jumper on the backplane in the "ON" position.
F251.040 Electronics unit	Self Check Alarm	The SIL monitoring function has detected a transmitter error.	Replace the transmitter or contact ABB Service.
F250.016 Electronics unit	Tx. memory fault detected Contact ABB Service	Error in the transmitter electronics unit.	Replace the electronics unit or contact ABB Service.
F248.036 Sensor	Incompatible snsTx+ snr are not the same series	Calibration mode is not compatible.	Contact ABB Service.
F246.032 Electronics unit	Defect digital potentiometer Transmitter Hardware fault ABB Service	Internal digital potentiometer for common mode rejection is defective.	Replace the electronics unit or contact ABB Service.
F245.047 Electronics unit	Stack NV Corrupt Contact ABB Service	The internal stack memory for PROFIBUS PA / FOUNDATION Fieldbus is defective.	Replace the electronics unit or contact ABB Service.
F244.031 Electronics unit	Internal supply voltage error Contact ABB Service	Failure of transmitter internal power supply.	Replace the electronics unit or contact ABB Service.
F236.024 Operation	DC to High Lot of NV-Resets Refer to instr. Manual	Multi-phase measuring media that produce a very high level of noise. Stones or solids that produce a very high level of noise. Galvanic voltages at the measuring electrodes. Conductivity of measuring medium is not evenly distributed (e.g., directly after injection points).	Check electrical connections and grounding of device. Activate empty pipe detector and calibrate if the meter tube is empty. Contact ABB Service.
F232.022 Electronics unit	Driver Error Uref = 0 Check wiring for open circuit Check fuse	Incorrect wiring (terminals M1, M2) or wire break / short circuit. Defective fuse in the coil circuit or moisture in the terminal box.	Check that the wiring (terminals M1, M2) is connected properly, check for wire breaks and short circuits. Check the coil circuit fuse. Check the connection box for moisture.
F228.020 Electronics unit	Error in Coil circuit Check wiring for short circuit	Incorrect wiring (terminals M1, M2) or wire break / short circuit. Fuse in the coil circuit is defective.	Check that the wiring (terminals M1, M2) is connected properly, check for wire breaks and short circuits. Check the coil circuit fuse.

Continued on next page.

Error no. / Range	Text on the LCD display	Cause	Remedy
F226.019 Electronics unit	AD Converter saturated Check empty pipe or Galv. Voltage	Signal at the input of the AD converter exceeds the maximum value of 2.5 V. No further measurement is possible.	If the pipeline is empty, check whether the empty pipe detection function is activated. In the "Diagnostics" menu, activate the empty pipe detection function. Check whether the current flowrate exceeds the configured flow range end value. If yes, increase Q_{max} (= flow range end value).

10.2.2 Function check

Error no. / Range	Text on the LCD display	Cause	Remedy
C190.045 Config.	An alarm is simulated Switch off alarm simulation	Simulation mode is activated.	In the "Diagnostics" menu, deactivate simulation mode.
C186.009 Config.	Tx Simulator/ Calibrator mode Switch off Calibrator Mode	The transmitter is operated on simulator 55XC4000.	In the "Diagnostics" menu, deactivate simulation mode.
C185.030 Operation	Hold last good known value Switch OFF Noise Reduction ABB Service	The noise exceeds the bandwidth set for noise reduction for a longer period of time.	Switch off noise reduction in the "Device Setup" menu or contact ABB Service.
C184.010 Config.	The Flowrate is set to zero Check digital in terminals 81,82	The function of the digital input (DI) is set to "External output switch-off" and the digital input (DI) is set to high signal (+24 V DC).	Set the digital input (DI) to low signal (0 VDC).
C182.008 Config.	Flowrate Simulation Switch off Simulation Mode	Simulation mode is activated. One of the following functions is simulated: Flowrate [%] or flowrate [unit] or flow velocity. These readings in simulation mode do not represent the system conditions.	In the "Diagnostics" menu, deactivate simulation mode.
C178.000 Config.	Simulated/ Fixed Current Output Simulation Mode? HART address>0?	The current output is simulated and is currently set to a specific value. The error message is displayed if the HART address is not 0 (HART multidrop mode, current output is set permanently to 4 mA).	Deactivate simulation mode in the "Process Alarm" menu or set the HART address to 0 in the "Communication" menu.
C177.015 Config.	HART Address <>0 Multidrop Mode Set HART Addr. = 0	HART address not 0 (HART multidrop mode, current output is set permanently to 4 mA).	Set the HART address to 0 in the "Communication" menu.
C176.011 Config.	Totalizer Stop Check digital in terminals 81,82	The function of the digital input (DI) is set to "external totalizer stop" and the digital input (DI) is set to high signal (+24 V DC).	Set the digital input (DI) to low signal (0 V DC).

Continued on next page.

Error no. / Range	Text on the LCD display	Cause	Remedy
C175.013 Config.	Totalizer Reset Check digital in terminals 81,82	The function of the digital input (DI) is set to "External totalizer reset" and the digital input (DI) is set to high signal (+24 V DC).	Set the digital input (DI) to low signal (0 V DC).
C174.002 Config.	Pulse Simulation selected on DO1 Switch off Simulation Mode	Simulation mode is activated.	In the "Process Alarm" menu, deactivate simulation mode.
C172.004 Config.	Pulse Simulation selected on DO2 Switch off Simulation Mode	Simulation mode is activated.	In the "Process Alarm" menu, deactivate simulation mode.
C168.001 Config.	Logic Simulation selected on DO1 Switch off Simulation Mode	Simulation mode is activated.	In the "Process Alarm" menu, deactivate simulation mode.
C164.003 Config.	Logic Simulation selected on DO2 Switch off Simulation Mode	Simulation mode is activated.	In the "Process Alarm" menu, deactivate simulation mode.
C158.039 Config.	Simulation of HART frequency Switch off Simulation Mode	Simulation mode is activated.	In the "Process Alarm" menu, deactivate simulation mode.
C154.018 Config.	Simulation Digital In Switch off Simulation Mode	Simulation mode is activated.	In the "Process Alarm" menu, deactivate simulation mode.

Error messages

10.2.3 Operation outside of specifications (Off Spec)

Error no. / Range	Text on the LCD display	Cause	Remedy
S149.021 Operation	Coil resistor out of limits Check wiring Contact ABB Service	Coil resistance too high: Coil or fuse for coil circuit is defective, or M1/M2 wired incorrectly, or wire break, or fluid is too hot. Coil resistance too low: Coil is defective or short circuit in M1 / M2 wiring.	Check wiring, check fuse for coil circuit, contact ABB Service.
S148.025 Operation	Empty Pipe Check Pipe	The pipeline in the system is empty.	Fill pipeline.
S146.043 Operation	Gas Bubble Alarm	Gas bubbles were detected in the fluid. The measured value is above the set switching threshold.	Check the process.
S144.033 Operation	Partially filled pipe(TFE) Check Pipe Or adjust Detector	Alarm tripped by Partial Filling Detector.	Check process, fill pipeline.
S143.042 Operation	Electrode Coating Alarm	Insulating or conductive deposits detected on measuring electrodes. The deposit value is above the set switching threshold.	Check process, flush pipeline, clean measuring electrodes.
S142.041 Operation	Conductivity Alarm	The fluid conductivity is outside the configured limit values.	Check process, adjust alarm limits if required.
S141.046 Operation	Sensor and or Housing Temperature to high	The flowmeter sensor temperature is outside the configured limit values.	Check process, adjust alarm limits if required.
S140.007 Operation	Flowrate >103% Check Flowrate Check Range Setting	The flowrate in the system exceeds the configured flow range end value by more than 3 %.	Increase the flow range end value in the "Easy Set-up - Q _{max} " menu.
S136.006 Operation	Max Alarm Flowrate	The current flowrate in the pipeline is greater than the max. alarm configured.	Reduce the flowrate or increase the value for the max. alarm.
S132.005 Operation	Min Alarm Flowrate	The current flowrate in the pipeline is lower than the min. alarm configured.	Increase the flowrate or increase the value for the min. alarm.

Continued on next page.

Error no. / Range	Text on the LCD display	Cause	Remedy
S124.029 Operation	Electr.Impedance too high Coating? Conductivity? Empty Pipe?	This could be caused by insulating deposits on the electrodes, conductivity that is too low, or an empty meter tube.	If the pipeline is empty, check whether the empty pipe detection function is activated. In the "Diagnostics" menu, activate the empty pipe detection function. Check conductivity, check deposits on the electrodes. Increase the value for "Elec. Imp. Max. Alarm" in the "Diagnostics - Alarm Limits" menu.
S122.026 Operation	Short-circuit E1 E2 with shield.	Galvanic voltages.	Increase the value in the "Diagnostics - Alarm Limits - Electr. V Max Alarm" menu and decrease the value for "Electr. V Min Alarm".
S120.023 Operation	Electrode Noise too high Switch on Noise Reduction	The noise at the measuring electrodes is above the limit value.	Check process.
S110.035 Operation	Sensor setup Cal-Status Set Cal-Status to calibrated	Sensor is uncalibrated or Cal status is not set to "calibrated".	Contact ABB Service.
S108.044 Operation	Pulse output is cutted off Check pulse out configuration	Incorrect configuration.	In the "Easy Set-up" menu, reduce the "Pulses per unit" value.

10.2.4 Maintenance

Error no. / Range	Text on the LCD display	Cause	Remedy
M099.027 Electronics unit	NV Corrupt	NV Memory, SensorMemory, FRAM defective.	Contact ABB Service.
M094.034 Electronics unit	Current out fault Comms. to MSP Check wiring! 20mA passive? Check BR901!	20 mA loop open, wire break or no power connected during operation as passive 20 mA output, max. permissible load exceeded or hardware defective.	Check for incorrect wiring, wire break. Check that the jumper to the 20 mA active / passive switchover is connected correctly to the backplane in the transmitter housing. Check whether the external power is connected during operation as 20 mA passive.
M090.014 Sensor	Errors Sensor Comms Bad EMC environment Check wiring	EMC environment or loose contact on the D1 or D2 terminals, or incorrect wiring, or short circuit, or moisture in the terminal box.	Check for incorrect wiring (terminals D1, D2), check terminal box.
M080.012 Operation	Display value is <1600h at Q _{max} Change eng. Unitfor Totalizer	Display value <1,600 h for Q _{max} .	Change the totalizer unit.

10.3 Overview of error states and alarms

Error no. / Range	Text on the LCD display	Current output behavior	Digital output behavior	Pulse output behavior	Display	Error maskable?
F254.038 Electronics unit	RAM Error in Transmitter Contact ABB Service	lout at Alarm	General Alarm	0 Hz	0 %	No
F253.037 Electronics unit	ROM Error in Transmitter Contact ABB Service	lout at Alarm	General Alarm	0 Hz	0 %	No
F252.017 Sensor	No Sensor Memory Check wiring Check switch SW3	lout at Alarm	General Alarm	0 Hz	0 %	No
F251.040 Electronics unit	Self Check Alarm	lout at Alarm	General Alarm	0 Hz	0 %	No
F250.016 Electronics unit	Tx. memory fault detected Contact ABB Service	lout at Alarm	General Alarm	0 Hz	0 %	No
F248.036 Sensor	Incompatible snsTx+ snr are not the same series	lout at Alarm	General Alarm	0 Hz	0 %	No
F246.032 Electronics unit	Defect digital potentiometer Transmitter Hardware fault ABB Service	lout at Alarm	General Alarm	0 Hz	0 %	No
F245.047 Electronics unit	Stack NV Corrupt Contact ABB Service	lout at Alarm	General Alarm	0 Hz	0 %	No
F244.031 Electronics unit	Internal supply voltage error Contact ABB Service	lout at Alarm	General Alarm	0 Hz	0 %	No
F236.024 Operation	DC to High Lot of NV-Resets Refer to instr. Manual	lout at Alarm	General Alarm	0 Hz	0 %	No
F232.022 Electronics unit	Driver Error Uref = 0 Check wiring for open circuit Check fuse	lout at Alarm	General Alarm	0 Hz	0 %	No
F228.020 Electronics unit	Error in Coil circuit Check wiring for short circuit	lout at Alarm	General Alarm	0 Hz	0 %	No
F226.019 Electronics unit	AD Converter saturated Check empty pipe or Galv. Voltage	lout at Alarm	General Alarm	0 Hz	0 %	No

Error no. / Range	Text on the LCD display	Current output behavior	Digital output behavior	Pulse output behavior	Display	Error maskable?
C190.045 Configuration	An alarm is simulated Switch off alarm simulation	Current value	No response	Current value	Current value	No
C186.009 Configuration	Tx Simulator/ Calibrator mode Switch off Calibrator Mode	Current value	Current value	Current value	Current value	Mask group
C185.030 Operation	Hold last good known value Switch OFF Noise Reduction ABB Service	Current value	No response	Current value	Current value	Mask group
C184.010 Configuration	The Flowrate is set to zero Check digital in terminals 81,82	4 mA (0 % flow)	No response	0 Hz	0 %	Mask group
C182.008 Configuration	Flowrate Simulation Switch off Simulation Mode	Current Value or High Alarm (flow > 105 %)	No response, Min/Max or General Alarm	Current value	Current value	Mask group
C178.000 Configuration	Simulated/ Fixed Current Output Simulation Mode? HART address>0?	Simulated value	No response	Current value	Current value	Mask group
C177.015 Configuration	HART Address <>0 Multidrop Mode Set HART Addr. = 0	4 mA	Current value	Current value	Current value	Mask group
C176.011 Configuration	Totalizer Stop Check digital in terminals 81,82	Current value	No response	0 Hz	Current value	Mask group
C175.013 Configuration	Totalizer Reset Check digital in terminals 81,82	Current value	No response	Current value	Current value	Mask group
C174.02 Configuration	Pulse Simulation selected on DO1 Switch off Simulation Mode	Current value	No response	Simulated value	Current value	Mask group
C172.04 Configuration	Pulse Simulation selected on DO2 Switch off Simulation Mode	Current value	No response	Simulated value	Current value	Mask group
C168.01 Configuration	Logic Simulation selected on DO1 Switch off Simulation Mode	Current value	Simulated value	No response	Current value	Mask group
C164.003 Configuration	Logic Simulation selected on DO2 Switch off Simulation Mode	Current value	Simulated value	No response	Current value	Mask group
C158.039 Configuration	Simulation of HART frequency Switch off Simulation Mode	Current value	No response	Current value	Current value	Mask group

Error no. range	Text on the LCD display	Current output behavior	Digital output behavior	Pulse output behavior	Display	Error maskable?
C154.018 Configuration	Simulation Digital In Switch off Simulation Mode	Current value	No response	Current value	Current value	Mask group
C149.021 Sensor	Coil resistor out of limits Check wiring Contact ABB Service	Current value	No response	Current value	Current value	Mask group
S148.025 Operation	Empty Pipe Check Pipe	Programmed alarm	Programmed alarm	0 Hz	0%	Mask single alarm
S149.021 Operation	Gas Bubble Alarm	No response	No response	No response	No response	Mask group
S146.043 Operation	Partially filled pipe(TFE) Check Pipe Or adjust Detector	Current value	Programmed alarm	Current value	Current value	Mask group
S144.033 Operation	Electrode Coating Alarm	Programmed alarm	Programmed alarm	Current value	Current value	Mask group
S143.042 Operation	Conductivity Alarm	Current value	Programmed alarm	Current value	Current value	Mask group
S142.041 Operation	Sensor and or Housing Temperature to high	Current value	Programmed alarm	Current value	Current value	Mask group
S141.046 Operation	Flowrate >103% Check Flowrate Check Range Setting	Current value	Programmed alarm	Current value	Current value	Mask group
S140.007 Operation	Max Alarm Flowrate	Programmed alarm	Collective Alarm	Current value	Current value	Mask single alarm
S136.006 Operation	Min Alarm Flowrate	Current value	Programmed alarm	Current value	Current value	Mask single alarm
S132.05 Operation	Coil resistor out of limits Check wiring Contact ABB Service	Current value	Programmed alarm	Current value	Current value	Mask single alarm
S124.029 Operation	Electr.Impedance too high Coating? Conductivity? Empty Pipe?	Current value	No response	Current value	Current value	Mask group
S122.026 Operation	Short-circuit E1 E2 with shield.	Current value	No response	Current value	Current value	Mask group

Error no. range	Text on the LCD display	Current output behavior	Digital output behavior	Pulse output behavior	Display	Error maskable?
S120.023 Operation	Electrode Noise too high Switch on Noise Reduction	Current value	No response	Current value	Current value	Mask group
S110.035 Sensor	Sensor setup Cal-Status Set Cal-Status to calibrated	Current value	Current value	Current value	Current value	Group mask
S108.044 Operation	Pulse output is cutted off Check pulse out configuration	Current value	No response	Maximum possible value	Current value	Group mask
M099.027 Elektronics unit	NV Corrupt	Current value	No response	Current value	Current value	Group mask
M94.034 Elektronics unit	Current out fault Comms. to MSP Check wiring! 20mA passive? Check BR901!	Low Alarm	No response	Current value	Current value	Single Alarm mask
M90.014 Sensor	Errors Sensor Comms Bad EMC environment Check wiring	Current value	No response	Current value	Current value	Group mask
M80.012 Operation	Display value is <1600h at Q_{max} Change eng. Unitfor Totalizer	Current value	No response	Current value	Current value	Group mask

Error messages

10.3.1 Error messages during commissioning

10.3.1.1 No sensor detected

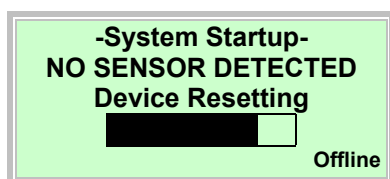

Once the device has been switched on, the sensor calibration data and the transmitter settings are loaded from the SensorMemory into the transmitter. If it is not possible to establish a communication with the SensorMemory¹⁾, the shown message appears on the LCD display.

Possible cause	Remedy
Terminals D1 / D2 wired incorrectly.	Check wiring.
Short-circuit or wire-break of wires D1 / D2.	Check signal cable.
Jumper SW3 not correctly connected to the backplane.	Check jumper SW3. Refer to Chapter 7.2 "Configuring the current output". <ul style="list-style-type: none"> off: SensorMemory provided in the flowmeter sensor (standard) on: No SensorMemory in flowmeter sensor
SensorMemory ¹⁾ defective.	Contact ABB Service

The device will restart after the progress bar is complete until either the communication with the SensorMemory¹⁾ is re-established successfully or the process is canceled by selecting "Offline". In Offline mode the device can be operated or parameterized, but no measurement is performed.

In Offline mode the error message "F252.017" is set.

1) The SensorMemory is a data memory integrated in the flowmeter sensor.

10.3.1.2 Error message "Incompatible sensor"



IMPORTANT (NOTE)

When commissioning the device, make sure that the transmitter is assigned to the sensor correctly. It is not possible to operate a flowmeter sensor of the 300 series with a transmitter of the 500 series.

If the transmitter is operated with a flowmeter sensor of another series, the following message appears on the transmitter display:

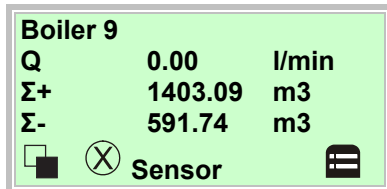

In the process display, a flow of zero flow is indicated, no flow measurement is performed.

1. Use to switch to the information level.

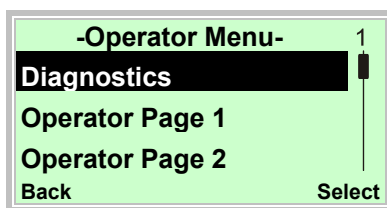

2. Use or , select the "Diagnostics" submenu.

3. Use to confirm your selection.

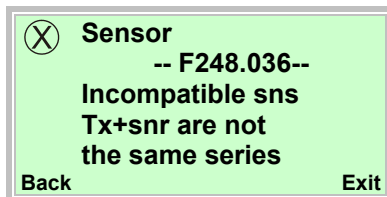

When attempting to commission a mixed installation, the shown error message appears.

The device cannot measure.

The indicated value for the current flowrate is zero flow.

The current output assumes its pre-configured state (lout for alarm).

Make sure that the flowmeter sensor and the transmitter are from the same series.

(e.g., flowmeter sensor ProcessMaster 300, transmitter ProcessMaster 300)

11 Maintenance

Repair and maintenance activities may only be performed by authorized customer service personnel.

When replacing or repairing individual components, original spare parts must be used.



NOTICE - Potential damage to parts!

The electronic components of the printed circuit board can be damaged by static electricity (observe ESD guidelines).

Make sure that the static electricity in your body is discharged before touching electronic components.

11.1 Flowmeter sensor

The flowmeter sensor is largely maintenance-free. The following items should be checked annually:

- Ambient conditions (air circulation, humidity),
- Seal integrity of the process connections,
- Cable entry points and cover screws,
- Operational reliability of the power supply feed, the lightning protection, and the station ground.

The flowmeter sensor electrodes must be cleaned when the flowrate information on the transmitter changes when recording the identical flowrate volume. If the display shows a higher flowrate, the contamination is insulating. If a lower flowrate is displayed, the contamination results in a short-circuit.

For repairs to the lining, electrodes or magnet coil, the flowmeter must be returned to the head office in Göttingen.



IMPORTANT (NOTE)

When sending the flowmeter sensor for repair to the head office of ABB Automation Products GmbH, complete the return form in the appendix and include with device.

When cleaning the exterior of meters, make sure that the cleaning agent used does not corrode the housing surface and the gaskets.

11.2 Gaskets

Some device designs are shipped with special gaskets. These gaskets must be used and installed properly to prevent leakage and ensure 3A conformity.

For all other device designs, use commercially available gaskets made from a compatible material for the measuring medium and prevailing temperature (rubber, PTFE, It, EPDM, silicon, Viton, etc.) or use 3A-compliant gasket material for HygienicMaster devices.



IMPORTANT (NOTE)

A wafer type sensor is installed without gaskets directly in the pipeline.

11.3 Replacing the transmitter or the sensor



IMPORTANT (NOTE)

When replacing the transmitter or sensor, ensure that they are assigned correctly. It is not possible to operate a sensor from the 300 series with a transmitter from the 500 series. The series (e.g. ProcessMaster 300 or ProcessMaster 500) is shown on the name plate of the transmitter or sensor.

11.3.1 Transmitter



WARNING – danger due to electric current!

When the housing is open, EMC protection is impaired and there is no longer any protection against accidental contact.

Before opening the housing, switch off the power supply.

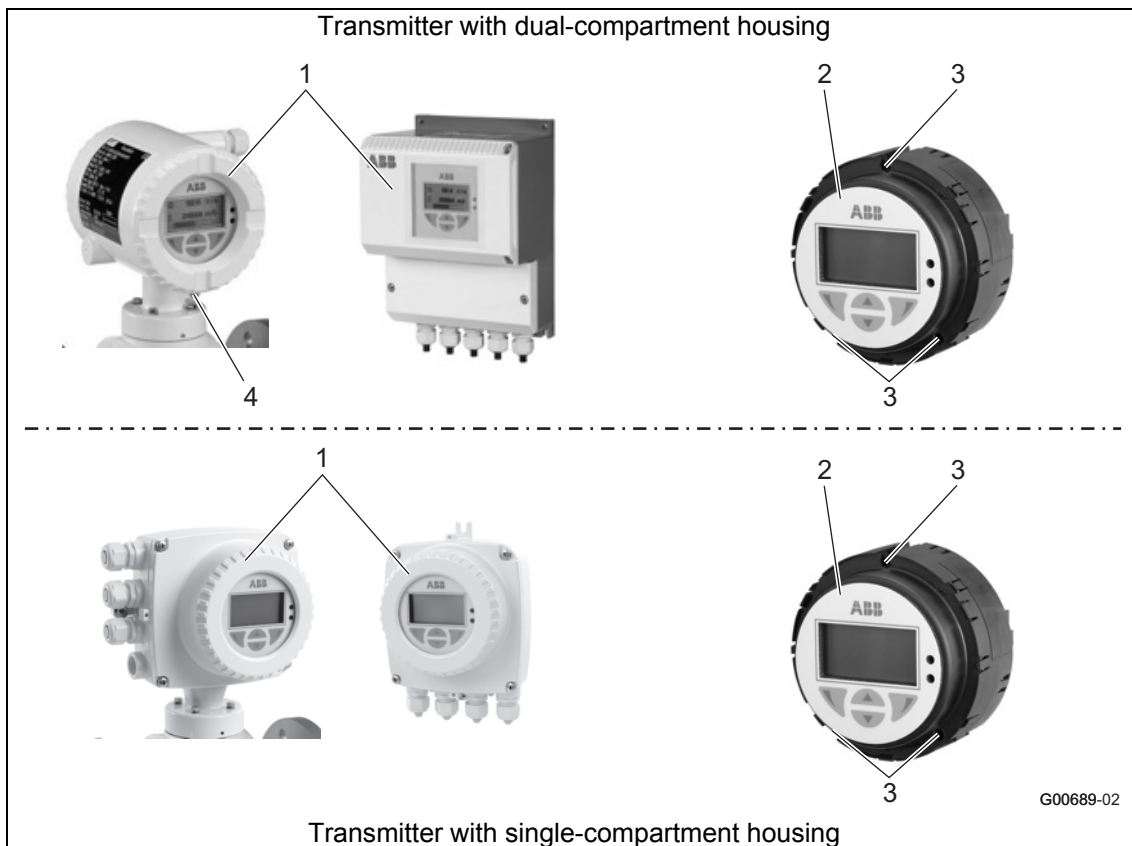

Fig. 68

Replace the transmitter plug-in as follows:

1. Switch off the power supply.
2. Unscrew the housing cover (1).
3. Loosen the screws (3) and pull out the transmitter plug-in unit (2).
4. Insert the new transmitter plug-in unit and retighten the screws (3).
5. Close the housing cover (1).
6. Download the system data (see chapter 7.5.1 "Downloading the system data" on page 70).

11.3.2 Sensor

**WARNING – danger due to electric current!**

When the housing is open, EMC protection is impaired and there is no longer any protection against accidental contact.

Before opening the housing, switch off the power supply.



Fig. 69

Replace the sensor as follows:

1. Switch off the power supply.
2. Open the cover safety device (3) if necessary.
3. Unscrew the housing cover (1).
4. Disconnect the signal cable (2) (if necessary, remove the potting compound).
5. Install the new sensor in accordance with the installation instructions.
6. Complete the electrical connection in accordance with the connection diagram.
7. Close the housing cover (1).
8. Download the system data (see chapter 7.5.1 "Downloading the system data" on page 70).

11.3.3 Downloading the system data

1. Switch on the power supply. After switching on the power supply, the following messages appear in succession on the LCD display:

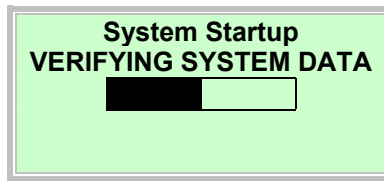
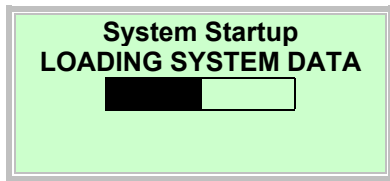

2. Download the system data as follows:

For a completely new system or initial start-up

- The calibration data of the flowmeter sensor and the transmitter settings are loaded from the SensorMemory¹⁾ into the transmitter.

After replacing the complete transmitter or transmitter electronic unit

- Select "Transmitter" with . The calibration data of the flowmeter sensor and the transmitter settings are loaded from the SensorMemory¹⁾ into the transmitter.

After replacing the sensor

- Select "Sensor" with . The calibration data of the flowmeter sensor are loaded from the SensorMemory¹⁾ into the transmitter. The transmitter settings are stored in the SensorMemory¹⁾. If the new sensor is a different size, check the currently configured flow range.

3. The flowmeter is ready for operation and will operate with factory settings or settings requested by the customer. To change the factory settings, refer to chapter 8 "Parameterization".

1) The SensorMemory is a data memory integrated in the flowmeter sensor.



IMPORTANT (NOTE)

System data must only be loaded during initial start-up. If the power supply is later switched off, the transmitter automatically loads all data the next time the power supply is switched on again.

A selection as described below (1-3) is not required.

12 Spare parts list

12.1 Fuses for transmitter electronics

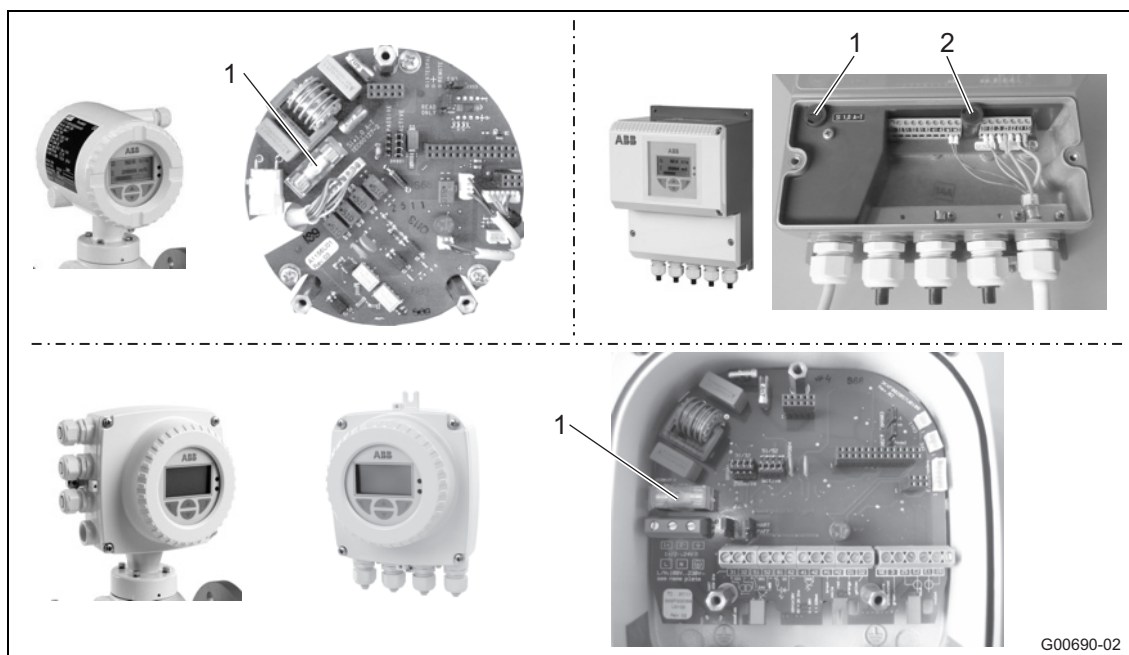

Fig. 70

No.	Name of part	Order number
1	Fuse (1.0 A) for power supply, suitable for all devices	D151B003U05
2	Fuse (0.25 A) for the coil circuit in the field housing, suitable for all devices	D151B003U02

12.2 Spare parts for devices with integral mount design

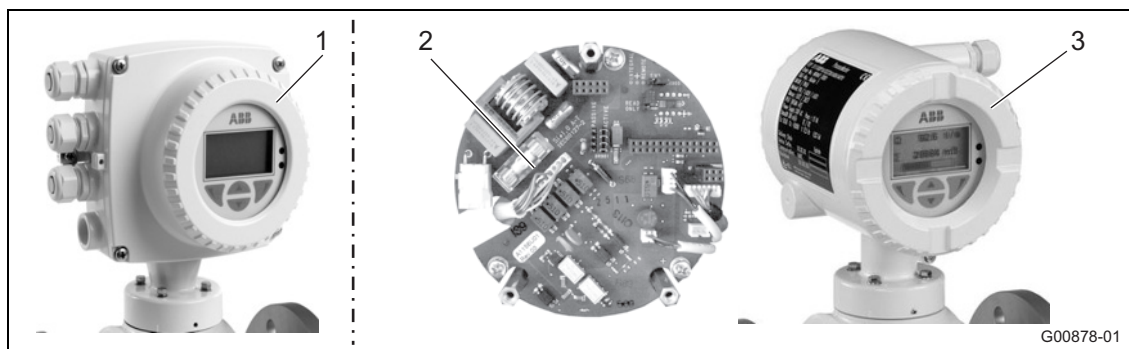

Fig. 71

No.	Name of part	Order number
1	Housing cover for transmitter with single-compartment housing with integral mount design	MJFA9915
2	Universal backplane for transmitter with dual-compartment housing	D685A1156U01
3	Front housing cover for transmitter with dual-compartment housing with integral mount design (standard, Ex Zone 2 / Div. 2)	D612A197U01
	Front housing cover for transmitter with dual-compartment housing with integral mount design (Ex Zone 1 / Div. 1)	D612A197U02

12.3 Spare parts for devices with remote mount design

12.3.1 field-mount housing

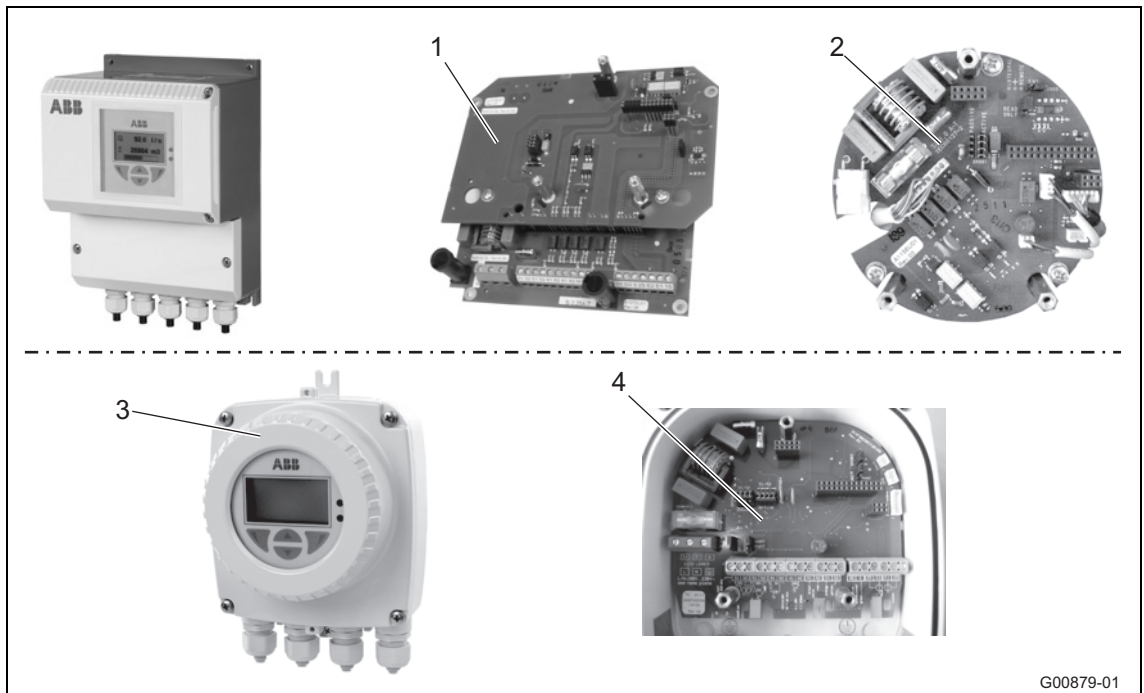

Fig. 72

No.	Name of part	Order number
1	Contact board assy for dual-compartment transmitter housing	D682A016U01
2	Universal backplane for dual-compartment transmitter housing	D685A1156U01
3	Housing cover for transmitter with single-compartment housing with remote mount design	MJBX9905
4	Backplane for transmitter with single-compartment housing with remote mount design	3KXF002058U0100

12.3.2 Round field-mount housing

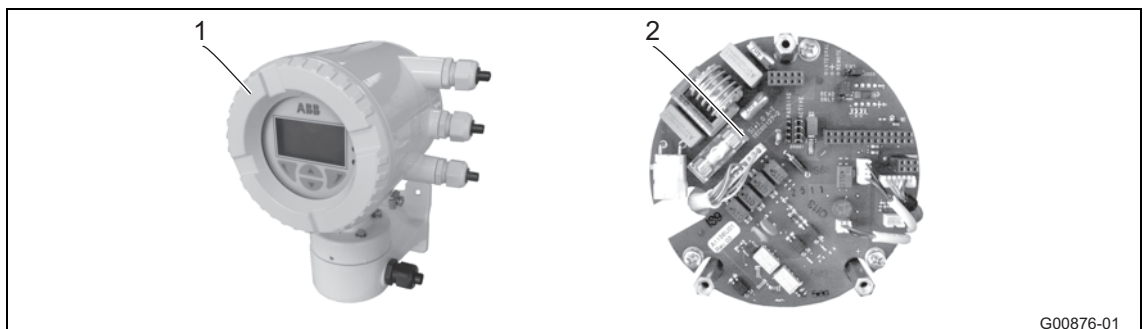

Fig. 73

No.	Name of part	Order number
1	Front housing cover for transmitter with dual-compartment housing with remote mount design (standard, Ex Zone 2 / Div. 2)	D612A197U01
	Front housing cover for transmitter with dual-compartment housing with remote mount design (Ex Zone 1 / Div. 1)	D612A197U02
2	Universal backplane for dual-compartment transmitter housing	D685A1156U01

12.3.3 Flowmeter sensor (Zone 2 / Div. 2)

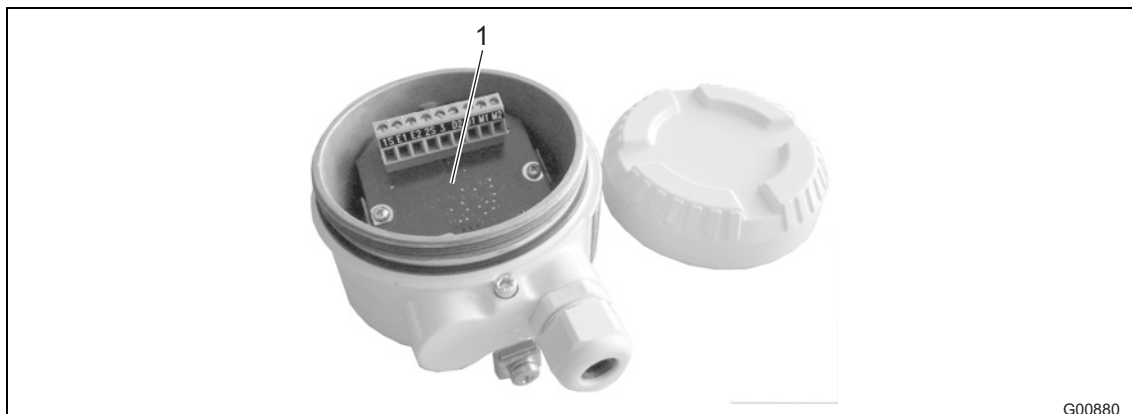

Fig. 74

No.	Name of part	Order number	
		for FEH model	for FEP model
1	Connection board (without preamplifier)	D685A1090U01	D685A1090U01
	Connection board (with preamplifier)	D685A1089U01	D685A1089U01

12.3.4 Flowmeter sensor (Zone 1 / Div. 1)

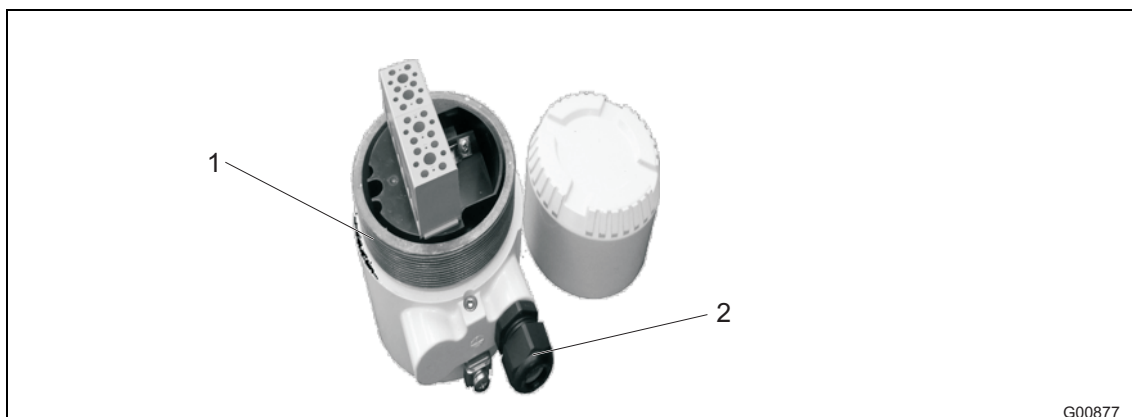

Fig. 75

No.	Name of part	Order number
1	O-ring	D101A034U06
2	Cable gland for Zone 1 / Div. 1, plastic, black, M20 x 1.5	D150A004U15

13 Performance specifications

13.1 General

13.1.1 Reference conditions

In accordance with EN 29104

Measuring medium temperature	20 °C (68 °F) ± 2 K
Ambient temperature	20 °C (68 °F) ± 2 K
Power supply	Nominal voltage acc. to name plate $U_n \pm 1 \%$, frequency $f \pm 1 \%$
Installation conditions	- Upstream > 10 x DN straight pipe section - Downstream > 5 x DN straight pipe section
Warm-up phase	30 min

13.1.2 Maximum measuring error

Pulse output

- Standard calibration FEP300 / FEH300:
± 0.4 % of measured value, ± 0.02 % Q_{maxDN}
(DN 3 ... 2000)
- Standard calibration FEP500 / FEH500:
± 0.3 % of measured value, ± 0.02 % Q_{maxDN}
(DN 1 ... 600, 800)
± 0.4 % of measured value, ± 0.02 % Q_{maxDN}
(DN 700 ... 900, 2000)
- Optional calibration: (DN 10 ... 600, 800)
± 0.2 % of measured value, ± 0.02 % Q_{maxDN}
- Only for FEH500: (DN 1 ... 2)
± 0.7 % of measured value, ± 0.02 % Q_{maxDN}

Q_{maxDN} : See table in chapter 7.6 "Flowmeter sizes, flow range" on page 78.

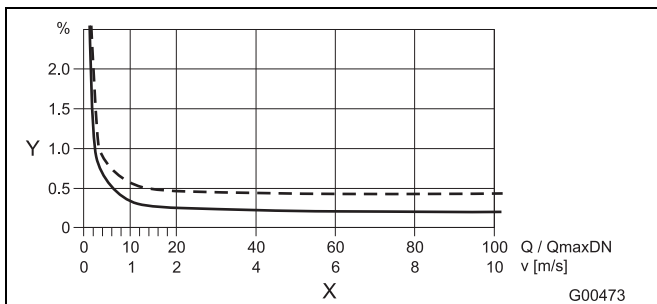

Fig. 76

Y Accuracy ± of measured value in [%]
X Flow velocity v in [m/s], Q / Q_{maxDN} [%]

Analog output effects

Same as pulse output plus ± 0.1 % of measured value ± 0.01 mA.

13.1.3 Reproducibility, response time

Reproducibility	≤ 0.11 % of measured value, $t_{meas} = 100 \text{ s}$, $v = 0.5 \dots 10 \text{ m/s}$
Response time of current output with damping of 0.02 seconds	As step function 0 ... 99 % $5 \tau \geq 200 \text{ ms}$ at 25 Hz excitation frequency $5 \tau \geq 400 \text{ ms}$ at 12.5 Hz excitation frequency $5 \tau \geq 500 \text{ ms}$ at 6.25 Hz excitation frequency

13.1.4 Power supply

Supply voltage	100 ... 230 V AC (-15 % / +10 %), 47 ... 64 Hz 24 V AC (-30 % / +10 %), 47 ... 64 Hz 24 V DC (-30 % / +30 %), ripple: < 5 %
Power consumption	AC ≤ 20 VA DC 12 W (switch-on current 5.6 A)
Screw terminals	Max. 2,5 mm ² (AWG 14)

Isolation of input / outputs

The current output, digital outputs DO1 and DO2, and digital input are electrically isolated from the flowmeter sensor input circuit and from each other. The same is valid for the signal outputs of the versions with PROFIBUS PA and FOUNDATION fieldbus.

Empty pipe detection

The function requires:
A conductivity of the measured fluid ≥ 20 μS/cm, a signal cable length ≤ 50 m (164 ft), a nominal diameter DN ≥ DN 10, and the flowmeter sensor must not be provided with a preamplifier.

Performance specifications

13.2 Mechanical properties

Integral mount design	Housing made of Aluminium	Housing made of stainless steel
Housing	Cast aluminum, painted	Stainless steel CF3M
Paint	Paint coat $\geq 80 \mu\text{m}$ thick, RAL 9002 (light gray)	-
Cable gland²⁾	Polyamide	Polyamide
	Stainless steel ¹⁾	Stainless steel ¹⁾

Remote mount design	
Housing	Cast aluminum, painted
Paint	Paint coat $\geq 80 \mu\text{m}$ thick, RAL 7012 (dark gray), front cover / rear cover RAL 9002 (light gray)
Cable gland²⁾	Polyamide
	Stainless steel ¹⁾
Weight	4.5 kg (9.92 lb)

- 1) In the case of hazardous area design for ambient temperature of $-40 \text{ }^\circ\text{C}$ ($40 \text{ }^\circ\text{F}$)
 2) Cable Gland with M20x1,5 thread or NPT thread with plug to be specified through modelcode

13.3 IP rating

According to EN 60529
 IP 65, IP 67, NEMA 4X

13.4 Vibration

According to EN 60068-2

- In the range 10 ... 58 Hz with max. 0.15 mm (0.006 inch) deflection ¹⁾
- In the range 58 ... 150 Hz max. 2 g acceleration ¹⁾

1) Peak load

13.5 Temperature data

Ambient temperature

- 20 ... 60 $^\circ\text{C}$ (-4 ... 140 $^\circ\text{F}$) Standard range
- 40 ... 60 $^\circ\text{C}$ (-40 ... 140 $^\circ\text{F}$) Extended range

Storage temperature

- 40 ... 70 $^\circ\text{C}$ (-40 ... 158 $^\circ\text{F}$)

14 Functional and technical properties - ProcessMaster

14.1 IP rating

According to EN 60529

IP 65, P 67, NEMA 4X

IP 68 (for remote mount design only)

14.2 Pipeline vibration

According to EN 60068-2-6, applies to aluminium transmitter housing only

- In the 10 ... 58 Hz range with max. 0.15 mm (0.006 inch) deflection
- In the 58 ... 150 Hz range with max. 2 g acceleration

14.3 Installation length

The flange devices comply with the installation lengths specified in VDI/VDE 2641, ISO 13359, or according to DVGW (process sheet W420, design WP, ISO 4064 short).

14.4 Signal cable

For remote mount design only

A 5 m (16.4 ft) cable is supplied.

If you require more than 5 m (16.4 ft), a signal cable can be separately purchased (for ordering informations see the following table or section).

Application	Signal cable	
	D173D031U01	D173D027U01
Non-Ex. (< DN 15)	✗	✓
Non-Ex. (≥ DN 15)	✓	✓
Zone 2 / Div. 2 (< DN 15)	✗	✓
Zone 2 / Div. 2 (≥ DN 15)	✓	✓
Zone 1 / Div. 1 (all nominal diameter)	✗	✓

- ✗ Application not permissible ■ Standard on delivery
 ✓ Application permissible

For the transmitter designed for use in zone 1, Div. 1 (model FET525), 10 m (32.8 ft) of signal cable is permanently connected to the transmitter.

Signal cable length and preamplifier

A preamplifier is required for cables > 50 m (164 ft).

Maximum signal cable length between flowmeter sensor and transmitter:

Preamplifier	Signal cable length
Without	Max. 50 m (164 ft) for conductivity ≥ 5 μS/cm
With	Max. 200 m (656 ft) for conductivity ≥ 5 μS/cm

14.5 Temperature data

The temperature range of the device is dependent upon a number of factors which influence the specification. These factors include - fluid temperature, ambient temperature, operating pressure, lining material and hazardous area classification.

14.5.1 Storage temperature

-40 ... 70 °C (-40 ... 158 °F)

14.5.2 Minimum permissible pressure as a function of measuring medium temperature

Lining	Nominal diameter	P _{operating} at mbar abs.	T _{operating} ¹⁾
Hard rubber	15 ... 2000 (1/2 ... 80")	0	< 90 °C (194 °F) < 80 °C (176 °F) ²⁾
		0	< 60 °C (140 °F)
PTFE	10 ... 600 (3/8 ... 24")	270	< 20 °C (68 °F)
		400	< 100 °C (212 °F)
		500	< 130 °C (266 °F)
Thick PTFE, high-temp. design	25 ... 80 100 ... 250 300	0	< 180 °C (356 °F)
		67	< 180 °C (356 °F)
		27	< 180 °C (356 °F)
PFA	3 ... 200 (1/10 ... 8")	0	< 180 °C (356 °F)
ETFE	25 ... 600 (1 ... 24")	100	< 130 °C (266 °F)
Linatex ²⁾	50 ... 600 (2 ... 24")	0	< 70 °C (158 °F)
Ceramic Carbide	25 ... 1000 (1 ... 40")	0	< 80 °C (176 °F)

1) For CIP/SIP cleaning, higher temperatures are permitted for limited time periods; refer to the table titled "Maximum permissible cleaning temperature".

2) Only China production site.

14.5.3 Maximum permissible cleaning temperature

CIP cleaning	Sensor lining	T _{max}	T _{max} minutes	T _{amb.}
Steam cleaning	PTFE, PFA	150 °C (302 °F)	60	25 °C (77 °F)
Fluids	PTFE, PFA	140 °C (284 °F)	60	25 °C (77 °F)

If the ambient temperature is > 25 °C, the difference must be subtracted from the max. cleaning temperature. T_{max} - Δ °C.

(Δ °C = T_{amb} - 25 °C)

14.5.4 Maximum ambient temperature depending on measuring medium temperature



IMPORTANT (NOTE)

When using the device in potentially explosive areas, the additional temperature specifications in the section titled "Ex relevant specifications" on the data sheet or in the separate Ex safety instructions (SM / FEX300 / FEX500 / ATEX / IECEx) or (SM / FEX300 / FEX500 / FM / CSA) must be observed.

14.5.4.1 ProcessMaster with integral mount design (standard sensor design)

Liner	Flange material	Ambient temperature		Measuring medium temperature	
		Minimum temperature	Max. temperature	Minimum temperature	Max. temperature
Hard rubber	Steel	-10 °C (14°F)	60 °C (140 °F)	-10 °C (14°F) -5 °C (23 °F) ¹⁾	90 °C (194 °F) 80 °C (176 °F) ¹⁾
Hard rubber	Stainless steel	-15 °C (5 °F)	60 °C (140 °F)	-15 °C (5 °F) -5 °C (23 °F) ¹⁾	90 °C (194 °F) 80 °C (176 °F) ¹⁾
Soft rubber	Steel	-10 °C (14°F)	60 °C (140 °F)	-10 °C (14°F)	60 °C (140 °F)
Soft rubber	Stainless steel	-15 °C (5 °F)	60 °C (140 °F)	-15 °C (5 °F)	60 °C (140 °F)
PTFE	Steel	-10 °C (14°F)	60 °C (140 °F) 45 °C (113 °F)	-10 °C (14°F)	90 °C (194 °F) 130 °C (266 °F)
PTFE	Stainless steel	-20 °C (-4 °F) -40 °C (-40 °F) ²⁾	60 °C (140 °F) 45 °C (113 °F)	-25 °C (-13 °F)	90 °C (194 °F) 130 °C (266 °F)
PFA ¹⁾	Steel	-10 °C (14°F)	60 °C (140 °F) 45 °C (113 °F)	-10 °C (14°F)	90 °C (194 °F) 130 °C (266 °F)
PFA ¹⁾	Stainless steel	-20 °C (-4 °F) -40 °C (-40 °F) ²⁾	60 °C (140 °F) 45 °C (113 °F)	-25 °C (-13 °F)	90 °C (194 °F) 130 °C (266 °F)
Thick PTFE ²⁾	Steel	-10 °C (14°F)	60 °C (140 °F) 45 °C (113 °F)	-10 °C (14°F)	90 °C (194 °F) 130 °C (266 °F)
Thick PTFE ²⁾	Stainless steel	-20 °C (-4 °F) -40 °C (-40 °F) ²⁾	60 °C (140 °F) 45 °C (113 °F)	-25 °C (-13 °F)	90 °C (194 °F) 130 °C (266 °F)
ETFE ³⁾	Steel	-10 °C (14°F)	60 °C (140 °F) 45 °C (113 °F)	-10 °C (14°F)	90 °C (194 °F) 130 °C (266 °F)
ETFE ³⁾	Stainless steel	-20 °C (-4 °F) -40 °C (-40 °F) ²⁾	60 °C (140 °F) 45 °C (113 °F)	-25 °C (-13 °F)	90 °C (194 °F) 130 °C (266 °F)
Linatex ¹⁾	Steel	-10 °C (14 °F)	60 °C (140 °F)	-10 °C (14 °F)	70 °C (158 °F)
Linatex ¹⁾	Stainless steel	-20 °C (-4 °F)	60 °C (140 °F)	-20 °C (-4 °F)	70 °C (158 °F)
Ceramic carbide	Steel	-10 °C (14 °F)	60 °C (140 °F) 45 °C (113 °F)	-10 °C (14°F)	80 °C (176 °F)
Ceramic carbide	Stainless steel	-20 °C (-4 °F)	60 °C (140 °F) 45 °C (113 °F)	-20 °C (-4 °F)	80 °C (176 °F)

14.5.4.2 ProcessMaster with integral mount design (high-temperature sensor design) ³⁾

Liner	Flange material	Ambient temperature		Measuring medium temperature	
		Minimum temperature	Max. temperature	Minimum temperature	Max. temperature
PFA ¹⁾	Steel	-10 °C (14°F)	60 °C (140 °F)	-10 °C (14°F)	180 °C (356 °F)
PFA ¹⁾	Stainless steel	-20 °C (-4 °F) -40 °C (-40 °F) ²⁾	60 °C (140 °F)	-20 °C (-13 °F)	180 °C (356 °F)
Thick PTFE ²⁾	Steel	-10 °C (14°F)	60 °C (140 °F)	-10 °C (14°F)	180 °C (356 °F)
Thick PTFE ²⁾	Stainless steel	-20 °C (-4 °F) -40 °C (-40 °F) ²⁾	60 °C (140 °F)	-20 °C (-13 °F)	180 °C (356 °F)
ETFE ³⁾	Steel	-10 °C (14 °F)	60 °C (140 °F)	-10 °C (14°F)	130 °C (266 °F)
ETFE ³⁾	Stainless steel	-20 °C (-4 °F) -40 °C (-40 °F) ²⁾	60 °C (140 °F)	-20 °C (-13 °F)	130 °C (266 °F)

1) For China production site only.
 2) For (optional) low-temperature version only.
 3) With sensor design level "B" only.

IMPORTANT (NOTE)

When using the device in potentially explosive areas, the additional temperature specifications in the section titled "Ex relevant specifications" on the data sheet or in the separate Ex safety instructions (SM / FEX300 / FEX500 / ATEX / IECEx) or (SM / FEX300 / FEX500 / FM / CSA) must be observed.

14.5.5 ProcessMaster with remote mount design (standard sensor design)

Liner	Flange material	Ambient temperature		Measuring medium temperature	
		Minimum temperature	Max. temperature	Minimum temperature	Max. temperature
Hard rubber	Steel	-10 °C (14°F)	60 °C (140 °F)	-10 °C (14°F) -5 °C (23 °F) 1)	90 °C (194 °F) 80 °C (176 °F) 1)
Hard rubber	Stainless steel	-15 °C (5 °F)	60 °C (140 °F)	-15 °C (5 °F) -5 °C (23 °F) 1)	90 °C (194 °F) 80 °C (176 °F) 1)
Soft rubber	Steel	-10 °C (14°F)	60 °C (140 °F)	-10 °C (14°F)	60 °C (140 °F)
Soft rubber	Stainless steel	-15 °C (5 °F)	60 °C (140 °F)	-15 °C (5 °F)	60 °C (140 °F)
PTFE	Steel	-10 °C (14°F)	60 °C (140 °F)	-10 °C (14°F)	130 °C (266 °F)
PTFE	Stainless steel	-25 °C (-13 °F) -40 °C (-40 °F) 2)	60 °C (140 °F)	-25 °C (-13 °F)	130 °C (266 °F)
PFA 1)	Steel	-10 °C (14°F)	60 °C (140 °F)	-10 °C (14°F)	130 °C (266 °F)
PFA 1)	Stainless steel	-25 °C (-13 °F) -40 °C (-40 °F) 2)	60 °C (140 °F)	-25 °C (-13 °F)	130 °C (266 °F)
Thick PTFE 2)	Steel	-10 °C (14°F)	60 °C (140 °F)	-10 °C (14°F)	130 °C (266 °F)
Thick PTFE 2)	Stainless steel	-25 °C (-13 °F) -40 °C (-40 °F) 2)	60 °C (140 °F)	-25 °C (-13 °F)	130 °C (266 °F)
ETFE 3)	Steel	-10 °C (14°F)	60 °C (140 °F)	-10 °C (14°F)	130 °C (266 °F)
ETFE 3)	Stainless steel	-25 °C (-13 °F)	60 °C (140 °F)	-25 °C (-13 °F)	130 °C (266 °F)
Linatex 1)	Steel	-10 °C (14 °F)	60 °C (140 °F)	-10 °C (14 °F)	70 °C (158 °F)
Linatex 1)	Stainless steel	-20 °C (-4 °F)	60 °C (140 °F)	-20 °C (-4 °F)	70 °C (158 °F)
Ceramic carbide	Steel	-10 °C (14 °F)	60 °C (140 °F)	-10 °C (14°F)	80 °C (176 °F)
Ceramic carbide	Stainless steel	-25 °C (-13 °F)	60 °C (140 °F)	-20 °C (-4 °F)	80 °C (176 °F)

14.5.5.1 ProcessMaster with remote mount design (high-temperature sensor) 3)

Liner	Flange material	Ambient temperature		Measuring medium temperature	
		Minimum temperature	Max. temperature	Minimum temperature	Max. temperature
PFA 1)	Steel	-10 °C (14°F)	60 °C (140 °F)	-10 °C (14°F)	180 °C (356 °F)
PFA 1)	Stainless steel	-25 °C (-13 °F) -40 °C (-40 °F) 2)	60 °C (140 °F)	-25 °C (-13 °F)	180 °C (356 °F)
Thick PTFE 2)	Steel	-10 °C (14°F)	60 °C (140 °F)	-10 °C (14°F)	180 °C (356 °F)
Thick PTFE 2)	Stainless steel	-25 °C (-13 °F) -40 °C (-40 °F) 2)	60 °C (140 °F)	-25 °C (-13 °F)	180 °C (356 °F)
ETFE 3)	Steel	-10 °C (14°F)	60 °C (140 °F)	-10 °C (14°F)	130 °C (266 °F)
ETFE 3)	Stainless steel	-25 °C (-13 °F) -40 °C (-40 °F) 2)	60 °C (140 °F)	-25 °C (-13 °F)	130 °C (266 °F)

- 1) For China production site only.
 2) For (optional) low-temperature version only.
 3) With sensor design level "B" only.

14.5.6 Overview sensor design level "C"

Sensor Size	Pressure rating	Carbon steel flange	PTFE	Hard rubber	Electrode design: Standard	Sensor temp. range: Standard Ambient temp. range: -20 ... 60 °C
DN 25 (1")	DIN PN 10, DIN PN 16, DIN PN 25, DIN PN 40 ASME CL 150, CL 300 JIS 10 K	X	X	—	X	X
DN 32 (1 1/4")		X	X	—	X	X
DN 40 (1 1/2")		X	X	X	X	X
DN 50 (2")		X	X	X	X	X
DN 65 (2 1/2")		X	X	X	X	X
DN 80 (3")		X	X	X	X	X
DN 100 (4")		X	X	X	X	X
DN 125 (5")		X	X	X	X	X
DN 150 (6")		X	X	X	X	X
DN 200 (8")		X	X	X	X	X
DN 250 (10")		X	X	X	X	X
DN 300 (12")		X	X	X	X	X
DN 350 (14")		X	X	X	X	X
DN 400 (16")		X	X	X	X	X
DN 450 (18")		X	X	X	X	X
DN 500 (20")		X	X	X	X	X
DN 600 (24")	X	X	X	X	X	

ASME flange, stainless steel, up to DN 400 (16") (CL150/300) up to DN 1000 (40") (CL150)

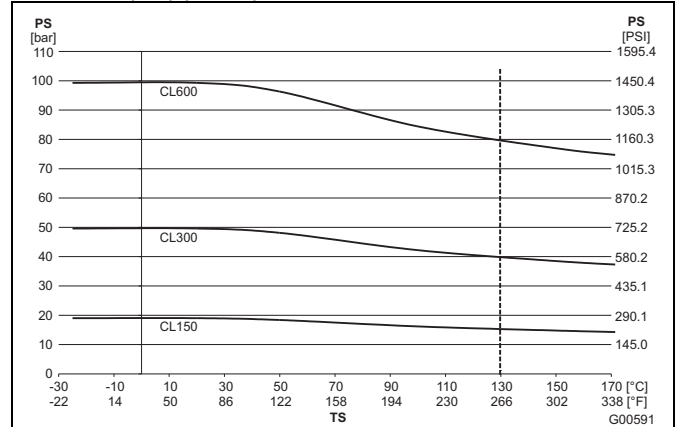

Fig. 78

DIN flange, steel, up to DN 600 (24")

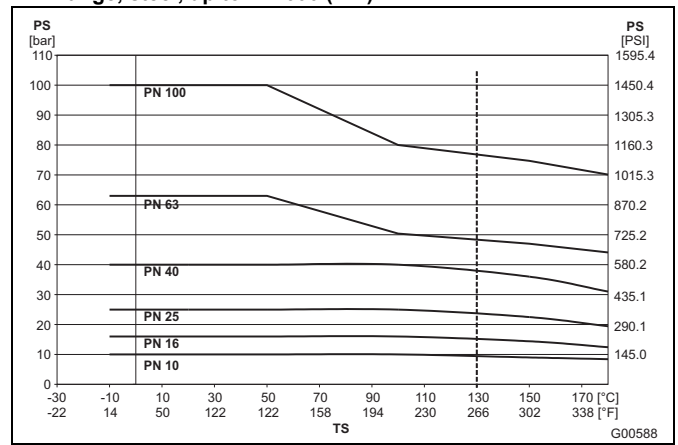

Fig. 79

14.6 Material load

Limits for the permissible fluid temperature (TS) and permissible pressure (PS) are calculated on the basis of the lining and flange material used in the device (refer to the name plate on the device).

14.6.1 Flowmeter sensor design level "B"

DIN flange stainless steel up to DN 600 (24")

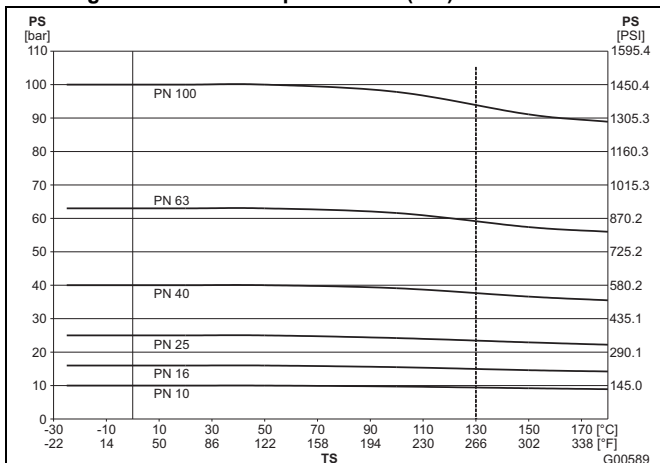

Fig. 77

ASME flange, steel, up to DN 400 (16") (CL150/300); up to DN 1000 (40") (CL150)

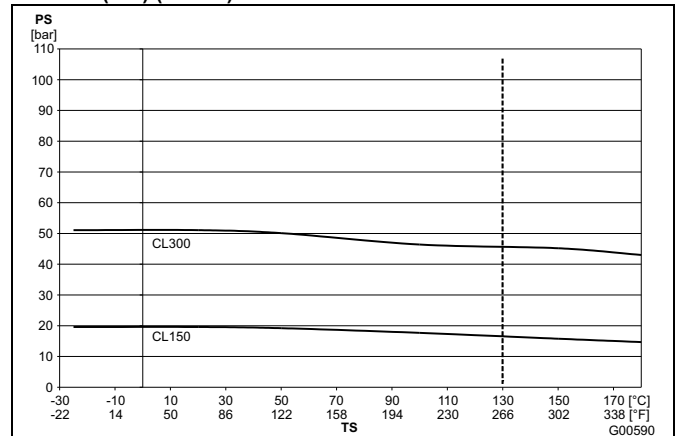

Fig. 80

JIS 10K-B2210 flange

Nominal diameter	Material	PN	TS	PS
32 ... 400 (1 1/4 ... 16")	Stainless steel	10	-25 ... 180 °C (-13 ... 356 °F)	10 bar (145 psi)
32 ... 400 (1 1/4 ... 16")	Steel	10	-10 ... 180 °C (14 ... 356 °F)	10 bar (145 psi)

DIN flange, stainless steel, DN 700 (28") up to DN 1000 (40")

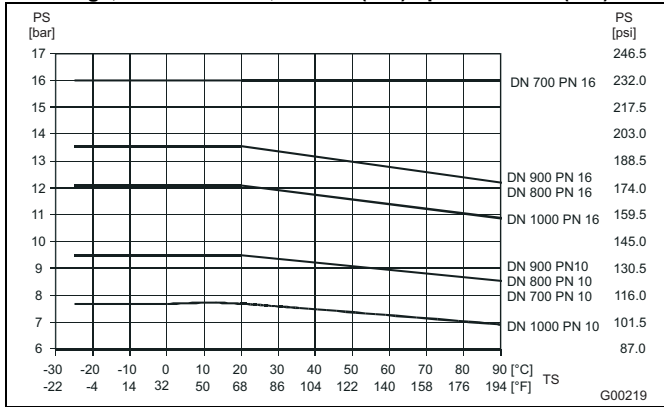

Fig. 81

DIN flange, steel, DN 700 (28") up to DN 1000 (40")

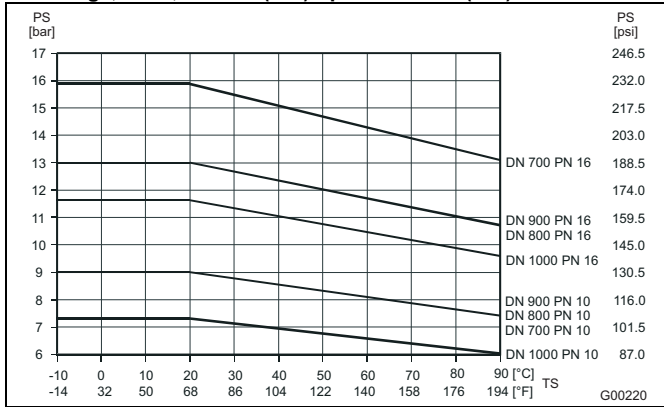

Fig. 82

ASME flange, Steel, DN 25 ... 400 (1 ... 24")

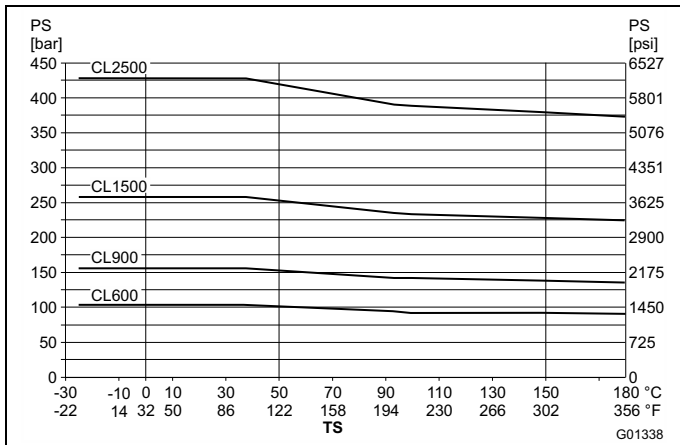

Fig. 83

ASME flange, stainless steel, DN 25 ... 400 (1 ... 24")

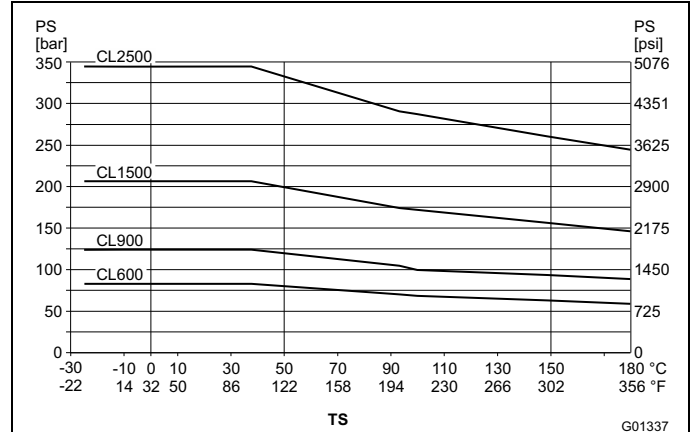

Fig. 84

14.6.2 Flowmeter sensor design level "C"

Steel casted housing, DN 25 ... 600 (1 ... 24")

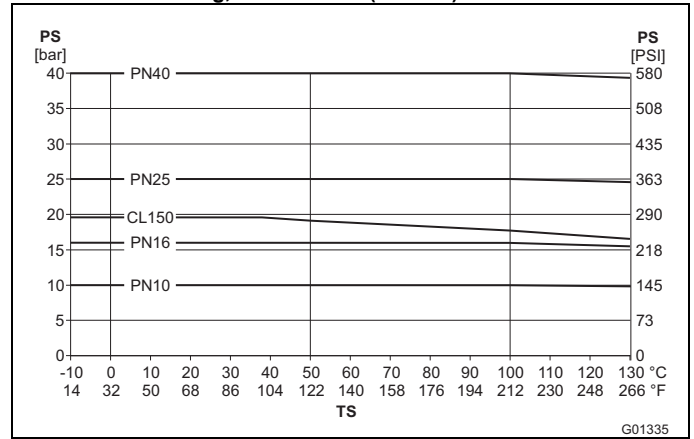

Fig. 85

Welded steel housing, DN 25 ... 600 (1 ... 24")

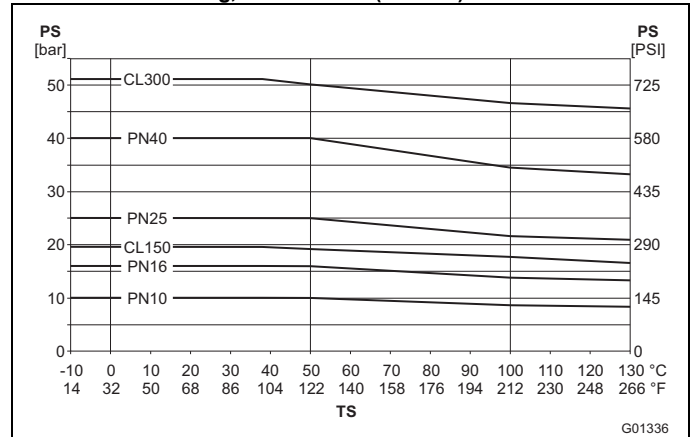



Fig. 86

14.7 Materials for flowmeter sensors

14.7.1 Wetted parts

Part	Standard	Option
Lining	PTFE, PFA, ETFE, hard rubber, soft rubber	Ceramic Carbide, Linatex
Measurement and grounding electrode for:		
- Hard rubber	Stainless steel 1.4571 (AISI 316Ti)	Hastelloy B-3 (2.4600), Hastelloy C-4 (2.4610), Titanium, Tantalum, Platinum-iridium, 1.4539 (AISI 904L), Tungsten carbide
- Soft rubber		
- PTFE, PFA, ETFE	Stainless steel 1.4539 (AISI 904L)	Stainless steel 1.4571 (AISI 316Ti) Hast. C-4 (2.4610) Hast. B-3 (2.4600) Titanium, Tantalum, Platinum-iridium
Grounding plate	Stainless steel	On request
Protection plate	Stainless steel	On request

14.7.2 Non-wetted parts (process connection)

Flowmeter sensor Design Level „B“		
 G01340		
Nominal diameter	Standard	Option
DN 3 ... 15 (1/10 ... 1/2")	Stainless steel ¹⁾	-
DN 20 ... 400 (3/4 ... 16")	Steel (galvanized) ²⁾	Stainless steel ¹⁾
DN 450 ... 2000 (18 ... 80")	Steel (painted) ²⁾	-

Flowmeter sensor Design Level „B“		
 G01342		
Nominal diameter	Standard	Option
DN 25 ... 400 (1 ... 16")	Stainless steel (AISI 316, 316L)	-

Flowmeter sensor Design Level „C“		
 G01341		
Nominal diameter	Standard	Option
DN 25 ... 600 (1 ... 24")	Steel (painted) ²⁾	-

The process connections are made of one of the materials listed below:

- 1.4301 (AISI 304), 1.4307, 1.4404 (AISI 316L) 1.4435 (AISI 316L), 1.4541 (AISI 321) 1.4571 (AISI 316Ti), ASTM A182 F304, ASTM A182 F304L, ASTM A182 F316L, ASTM A182 F321, ASTM A182 F316Ti, ASTM A182 F316, 0Cr18Ni9, 0Cr18Ni10, 0Cr17Ni13Mo2, 0Cr27Ni12Mo3, 1Cr18Ni9Ti, 0Cr18Ni12Mo2Ti
- 1.0038, 1.0460, 1.0570, 1.0432, ASTM A105, Q255A, 20#, 16Mn

14.7.3 Flowmeter sensor housing

Flowmeter sensor Design Level „B“	
 G01340	
Housing	Dual-shell casing, cast aluminum, painted, paint coat, $\geq 80 \mu\text{m}$ thick, RAL 9002
DN 3 ... 400 (1/10 ... 16")	
DN 450 ... 2000 (18 ... 80")	Welded steel design, painted, paint coat, $\geq 80 \mu\text{m}$ thick, RAL 9002
Terminal box	Aluminum alloy, painted, $\geq 80 \mu\text{m}$ thick, light gray, RAL 9002
Meter tube	Stainless steel ³⁾
Cable gland ⁴⁾	Polyamide
	CrNi steel (in the case of hazardous area design for ambient temperature of $-40 \text{ }^\circ\text{C}$ ($40 \text{ }^\circ\text{F}$))

Flowmeter sensor Design Level „B“	
 G01342	
Housing + Meter tube	Stainless steel (AISI 316, 316L)
DN 25 ... 400 (1 ... 16")	
Cable gland ⁴⁾	Polyamide

Flowmeter sensor Design Level „C“	
 G01341	
Housing + Meter tube	Steel, painted, paint coat, $\geq 80 \mu\text{m}$ thick, RAL 9002
DN 25 ... 600 (1 ... 24")	
Terminal box	Aluminum alloy, painted, $\geq 80 \mu\text{m}$ thick, light gray, RAL 9002
Cable gland ⁴⁾	Polyamide

The meter tube is made of one of the materials listed below:

- 1.4301, 1.4307, 1.4404, 1.4435, 1.4541, 1.4571
ASTM materials:
Grade TP304, TP304L, TP316L, TP321, TP316Ti, TP317L, 0Cr18Ni9, 0Cr18Ni10, 0Cr17Ni14Mo2, 0Cr27Ni12Mo3, 0Cr18Ni10Ti
- Cable Gland with M20x1,5 thread or NPT thread with plug to be specified through modelcode

15 Functional and technical properties - HygienicMaster

15.1 Flowmeter sensor

15.1.1 IP rating according to EN 60529

IP 65, IP 67, NEMA 4X
IP 68 (for remote mount design only)

15.1.2 Pipeline vibration according to EN 60068-2-6

For devices with integral mount design the following applies:
(transmitter mounted directly on the flowmeter sensor)

- In the 10 ... 58 Hz range with max. 0.15 mm (0.006 inch) deflection
- In the 58 ... 150 Hz max. 2 g acceleration (does not apply to DN 1...2)

For devices with remote mount design the following applies:
Transmitter

- In the 10 ... 58 Hz range with max. 0.15 mm (0.006 inch) deflection
- In the 58 ... 150 Hz range with max. 2 g acceleration

Flowmeter sensor

- In the 10 ... 58 Hz range with max. 0.15 mm (0.006 inch) deflection
- In the 58 ... 150 Hz max. 2 g acceleration (does not apply to DN 1...2)

15.1.3 Installation length

The flange devices comply with the installation lengths specified in VDI/VDE 2641, ISO 13359, or according to DVGW (process sheet W420, design WP, ISO 4064 short).

15.1.4 Signal cable (for external transmitters only)

A 5 m (16.4 ft) cable is supplied.

If you require more than 5 m (16.4 ft), a cable can be purchased using order number D173D027U01.

Alternatively, the cable with order number AD173D031U01 can be used for transmitters without explosion protection (model FEP321, FEH321) from DN 15 and for transmitters for use in Zone 2 (model FEP325, FEH325) from DN 15.

Pre-amplifier

Maximum signal cable length between flowmeter sensor and transmitter:

a) Without pre-amplifier:

- Max. 50 m (164 ft) for conductivity $\geq 5 \mu\text{S/cm}$

A pre-amplifier is required for cables $> 50 \text{ m}$ (164 ft).

b) With pre-amplifier

- Max. 200 m (656 ft) for conductivity $\geq 5 \mu\text{S/cm}$

15.1.5 Temperature range

Storage temperature

-40 ... 70 °C (-40 ... 158 °F)

Min. permissible pressure as a function of measuring medium temperature

Lining	Nominal diameter	P _{operating} at mbar abs.	T _{operating} ¹⁾
PFA	DN 3 ... 100 (1/10 ... 4")	0	< 180 °C (356 °F)
PEEK	DN 1 ... 2 (1/25 ... 1/12")	0	< 120 °C (248 °F)

1) For CIP/SIP cleaning, higher temperatures are permitted for limited time periods; refer to the table titled "Maximum permissible cleaning temperature".

Max. permissible cleaning temperature

CIP cleaning	Flowmeter sensor lining	T _{max}	T _{max} minutes	T _{amb.}
Steam cleaning	PFA	150 °C (302 °F)	60	25 °C (77 °F)
Fluids	PFA	140 °C (284 °F)	60	25 °C (77 °F)

If the ambient temperature is $> 25 \text{ °C}$, the difference must be subtracted from the max. cleaning temperature. $T_{\text{max}} - \Delta \text{ °C}$.

($\Delta \text{ °C} = T_{\text{amb}} - 25 \text{ °C}$)

Max. permissible temperature shock

Lining	Max. temp. shock Temp. diff. in °C	Temp. gradient °C / min
PFA	Any	Any
PEEK	Any	Any

Max. ambient temperature as a function of measuring medium temperature



IMPORTANT (NOTE)

When using the device in explosion hazardous areas, the additional temperature specifications in the section titled "Ex relevant specifications" on the data sheet or in the the separate Ex safety instructions (SM/FEX300/FEX500/ATEX/IECEX) or (SM/FEX300/FEX500/FM/GSA) must be observed.

Standard temperature design

Model	Process connection	Ambient temperature		Measuring medium temperature	
		Min. temp ¹⁾	Max. temp.	Min. temp.	Max. temp ²⁾
FEH311 FEH315	Flange	-20 °C (-4 °F)	60 °C (140 °F) 40 °C (104 °F)	-25 °C (-13 °F)	100 °C (212 °F) 130 °C (266 °F)
	Variable process connections	-20 °C (-4 °F)	60 °C (140 °F) 40 °C (104 °F)	-25 °C (-13 °F)	100 °C (212 °F) 130 °C (266 °F)
FEH321 FEH325	Flange	-20 °C (-4 °F)	60 °C (140 °F) 40 °C (104 °F)	-25 °C (-13 °F)	100 °C (212 °F) 130 °C (266 °F)
	Variable process connections	-20 °C (-4 °F)	60 °C (140 °F) 40 °C (104 °F)	-25 °C (-13 °F)	100 °C (212 °F) 130 °C (266 °F)

High temperature design (from size DN 10 (3/8"))

Model	Process connection	Ambient temperature		Measuring medium temperature	
		Min. temp ¹⁾	Max. temp.	Min. temp.	Max. temp.
FEH311 FEH315	Flange	-20 °C (-4 °F)	60 °C (140 °F)	-25 °C (-13 °F)	180 °C (356 °F)
FEH321 FEH325	Flange	-20 °C (-4 °F)	60 °C (140 °F)	-25 °C (-13 °F)	180 °C (356 °F)

1) The following is valid for the low temperature design (option): -40°C (-40°F).

2) For CIP/SIP cleaning, higher temperatures are permitted for limited time periods; refer to the table „Max. permissible cleaning temperature“ on page 171.

15.1.6 Material load

Limits for the permissible fluid temperature (TS) and permissible pressure (PS) are calculated on the basis of the lining and flange material used in the device (refer to the name plate on the device).

Process connection	Nominal diameter	PS _{max} bar (PSI)	TS
Wafer type	DN 3 ... 50 (1/10 ... 2")	40 (580)	-25 ... 130 °C (-13 ... 266 °F)
	DN 65 ... 100 (2 1/2 ... 4")	16 (232)	
Welded spuds	DN 3 ... 40 (1/10 ... 1 1/2")	40 (580)	-25 ... 130 °C (-13 ... 266 °F)
	DN 50, DN 80 (2", 3")	16 (232)	
	DN 65, DN 100 (2 1/2", 4")	10 (145)	
Threaded pipe connection conforming to DIN 11851	DN 3 ... 40 (1/10 ... 1 1/2")	40 (580)	-25 ... 130 °C (-13 ... 266 °F)
	DN 50, DN 80 (2", 3")	16 (232)	
	DN 65, DN 100 (2 1/2", 4")	10 (145)	
Tri-Clamp conforming to DIN 32676	DN 3 ... 50 (1/10 ... 2")	16 (232)	-25 ... 121 °C (-13 ... 250 °F)
	DN 65 ... 100 (2 1/2 ... 4")	10 (145)	
Tri-Clamp in acc. with ASME BPE	DN 3 ... 100 (1/10 ... 4")	10 (145)	-25 ... 130 °C (-13 ... 266 °F)
External thread ISO 228 / DIN 2999	DN 3 ... 25 (1/10 ... 1")	16 (232)	-25 ... 130 °C (-13 ... 266 °F)
OD tubing	DN 3 ... 50 (1/10 ... 2")	10 (145)	-25 ... 130 °C (-13 ... 266 °F)
1/8" sanitary connectors	DN 1 ... 2 (1/25 ... 1/12")	10 (145)	-10 ... 120 °C (-14 ... 248 °F)

DIN flange stainless steel to DN 100 (4")

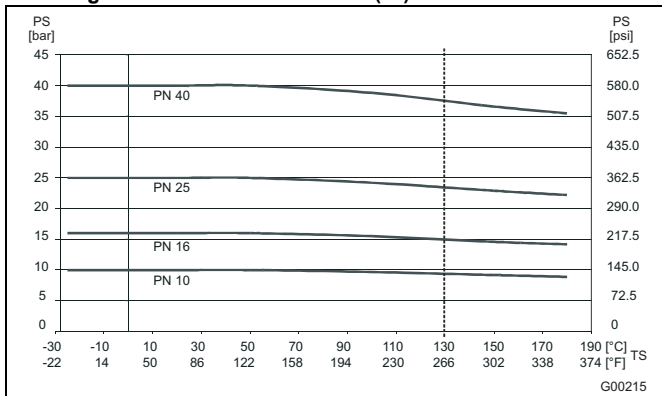

Fig. 87

ASME flange, stainless steel, up to DN 100 (4") (CL150 / 300)

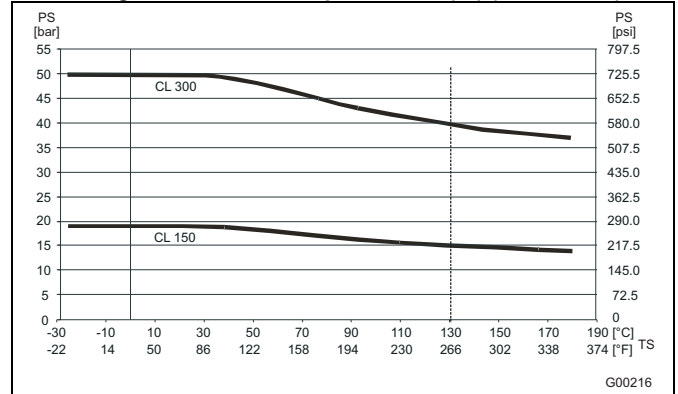

Fig. 88

For CIP / SIP cleaning, higher temperatures are permitted for limited time periods; refer to the table titled "Maximum permissible cleaning temperature".

JIS 10K-B2210 flange

Nominal diameter	Material	PN	TS	PS [bar]
25 ... 100 (1 ... 4")	Stainless steel	10	-25 ... 180 °C (-13 ... 356 °F)	10 (145 psi)

Wafer type design

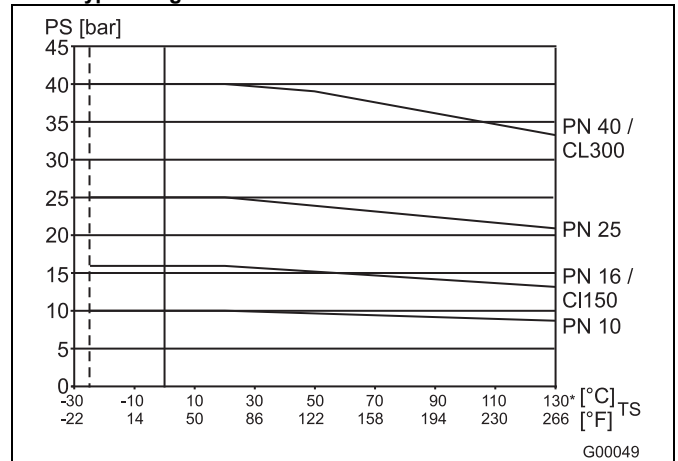

Fig. 89

JIS 10K-B2210 wafer type design

Nominal diameter	Material	PN	TS	PS [bar]
DN 32 ... 100 (1 1/4 ... 4")	1.4404	10	-25 ... 130 °C (-13 ... 266 °F)	10 (145 psi)
	1.4435			
	1.4301			

15.1.7 Mechanical properties

Wetted parts

Part	Standard	Option
Lining	PFA from DN 3 (1/10") PEEK DN 1 ... 2 (1/25 ... 1/12")	-
Signal and grounding electrode	CrNi steel 1.4539 (AISI 904L)	CrNi steel 1.4571 (AISI 316Ti) Hast. C-4 (2.4610) Hast. B-3 (2.4600) Titanium, tantalum, Platinum-iridium
Gaskets (for Weld stubs, threaded connection, Tri-Clamp, external threads)	EPDM (Ethylene-Propylene) with FDA approval, silicone with FDA approval (CIP-resistant, no oils or grease)	Silicone with FDA approval (option, oil or grease resistant) PTFE with FDA approval (DN 3 ... 8 (1/10 ... 5/16"))
Gasket for 1/8" sanitary connectors	PTFE	Viton (only in combination with PVC process connection)
Process connection		
- Welded spuds, Tri-Clamp, etc.	CrNi steel 1.4404 (AISI 316L)	-
- OD tubing	CrNi steel 1.4435 (AISI 316L)	-

Non-wetted parts

	Standard	Option
Flange	CrNi steel 1.4571 (AISI 316Ti)	-

Flowmeter sensor housing

	Standard
Housing	Deep-drawn housing CrNi steel 1.4301 (AISI 304), 1.4308
Terminal box	CrNi steel 1.4308 (AISI 304)
Meter tube	Stainless steel
Cable gland	Polyamide Stainless steel (in the case of hazardous area design for ambient temperature of -40 °C (40 °F))

16 Appendix

16.1 Return form

Statement on the contamination of devices and components

Repair and/or maintenance work will only be performed on devices and components if a statement form has been completed and submitted.

Otherwise, the device/component returned may be rejected. This statement form may only be completed and signed by authorized specialist personnel employed by the operator.

Customer details:

Company: _____

Address: _____

Contact person: _____

Telephone: _____

Fax: _____

Email: _____

Device details:

Type: _____

Serial no.: _____

Reason for the return/description of the defect: _____

Was this device used in conjunction with substances which pose a threat or risk to health?

Yes No

If yes, which type of contamination (please place an X next to the applicable items)?

Biological Corrosive/irritating Combustible (slightly/extremely combustible)

Toxic Explosive Other Toxic substances

Radioactive

Which substances have come into contact with the device?

1. _____

2. _____

3. _____

We hereby state that the devices/components shipped have been cleaned and are free from any dangerous or poisonous substances.

Town/city, date

Signature and company stamp

16.2 Overview of parameter settings (factory settings)

	Possible parameter settings	Factory setting
Sensor TAG	Alphanumeric, max. 20 characters	None
Sensor Location TAG	Alphanumeric, max. 20 characters	None
Q _{max}	Depending on nominal diameter (see table in Section 6.6)	Q _{max} DN (see table in Section 6.6)
Q (Flowrate) Unit	l/s; l/min; l/h; ml/s; ml/min; m3/s; m3/min; m3/h; m3/d; hl/h; g/s; g/min; g/h; kg/s; kg/min; kg/h; kg/d; t/min; t/h; t/d	l/min
Totalizer/Pulse Unit	m3; l; ml; hl; g; kg; t	l
Pulses per Unit		1
Pulse Width	0,1 ... 2,000 ms	100 ms
Damping (1 Tau)	0,02 ... 60 sec.	1
DO1 Alarm Config	Pulse F/Pulse R, Pulse F, General Alarm, Min. Flowrate Alarm, Max. Flowrate Alarm, Empty Pipe, TFE, Only available for FEP500 / FEH500 are: Gas Bubble, Conductivity, Coating, Sensor Temp, Signal	Pulse F/Pulse R
DO1 Drive	Active, Passive	Passive
DO2 Alarm Config	F/R Signal, Pulse R, General Alarm, Min. Flowrate Alarm, Max. Flowrate Alarm, Empty Pipe, TFE, Only available for FEP500 / FEH500 are: Gas Bubble, Conductivity, Coating, Sensor Temp, Signal	F/R Signal
Digital Input DI	No Function, Totalizer Reset(All), Flowrate to Zero, System Zero Adjust, Totalizer Stop(All), Only available for FEP500 / FEH500 are: Switchover Dual Range, Start/Stop Batching	Flowrate to Zero
Current Output	4 ... 20 mA, 4 ... 12 ... 20 mA	4 ... 20 mA
Iout at Alarm (in accordance with NE43)	High alarm, adjustable to 21 ... 23 mA or Low alarm, adjustable to 3.5 ... 3.6 mA	High alarm, 21.8 mA For details refer to Section 9.2.
Iout at Flow >103%	Off (no signaling, current output remains at 20.5 mA), high alarm, low alarm	Off
Low Flow Cut Off	0 ... 10 %	1 %
Empty Pipe Detector	On / Off	Off
TFE Detector	On / Off	Off

16.2.1 For Profibus PA version

	Possible parameter settings	Factory setting
PA Addr. (BUS)	0 ... 126	126
Ident Nr. Selector	0 x 9700, 0 x 9740, 0 x 3430	0 x 3430

16.3 Declaration of conformity

**IMPORTANT (NOTE)**

All documentation, declarations of conformity and certificates are available in ABB's download area.

www.abb.com/flow

**IMPORTANT (NOTE)**

This is a class A device (industrial sector). This device can cause radio interferences in residential areas. In this case, the operator may be required to take appropriate measures to remedy the fault.

ABB Limited**Measurement & Analytics**

Howard Road, St. Neots
Cambridgeshire, PE19 8EU
UK

Tel: +44 (0)870 600 6122

Fax: +44 (0)1480 213 339

Email: enquiries.mp.uk@gb.abb.com

ABB Inc.**Measurement & Analytics**

125 E. County Line Road
Warminster, PA 18974
USA

Tel: +1 215 674 6000

Fax: +1 215 674 7183

ABB Engineering (Shanghai) Ltd.**Measurement & Analytics**

No. 4528, Kangxin Highway, Pudong
New District
Shanghai, 201319,
P.R. China

Tel: +86(0) 21 6105 6666

Fax: +86(0) 21 6105 6677

Email: china.instrumentation@cn.abb.com

abb.com/flow



We reserve the right to make technical changes or modify the contents of this document without prior notice. With regard to purchase orders, the agreed particulars shall prevail. ABB does not accept any responsibility whatsoever for potential errors or possible lack of information in this document.

We reserve all rights in this document and in the subject matter and illustrations contained therein. Any reproduction, disclosure to third parties or utilization of its contents – in whole or in parts – is forbidden without prior written consent of ABB.

© 2019 ABB

All rights reserved

3KXF231300R4201