

OFASA 3

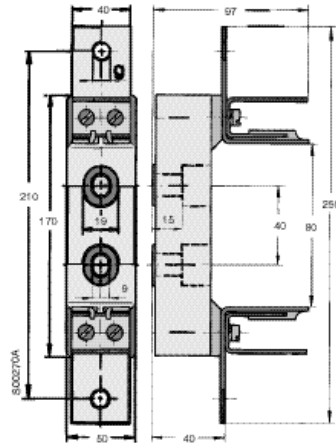

OFASB 3

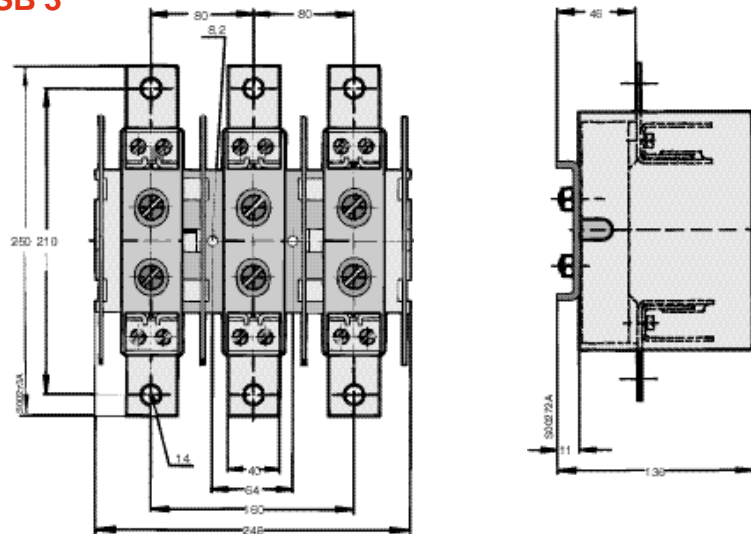

OFAX 00

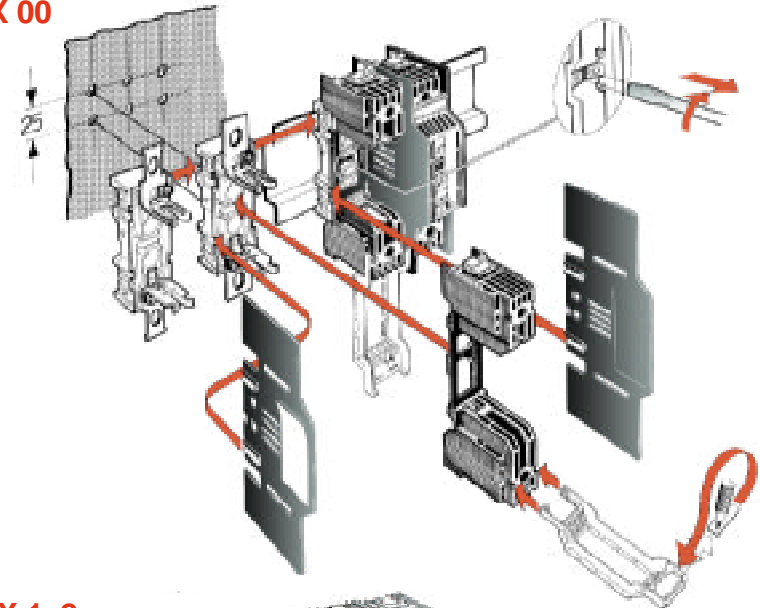

OFAX 1, 2

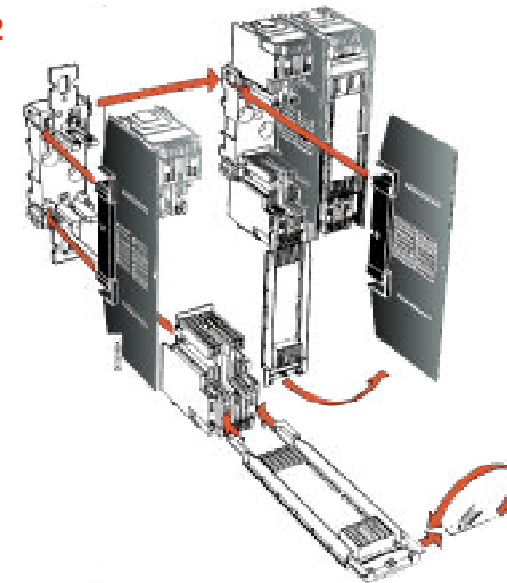

OFAX_A_

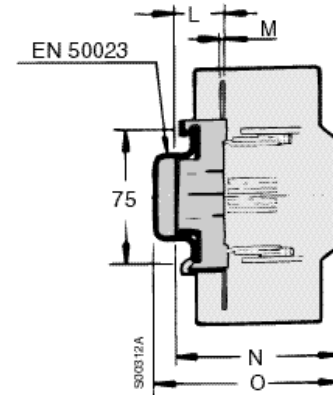
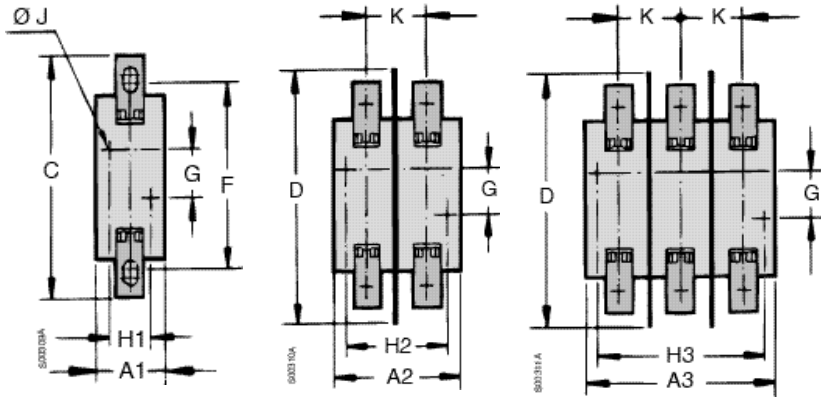

OFAX_P_

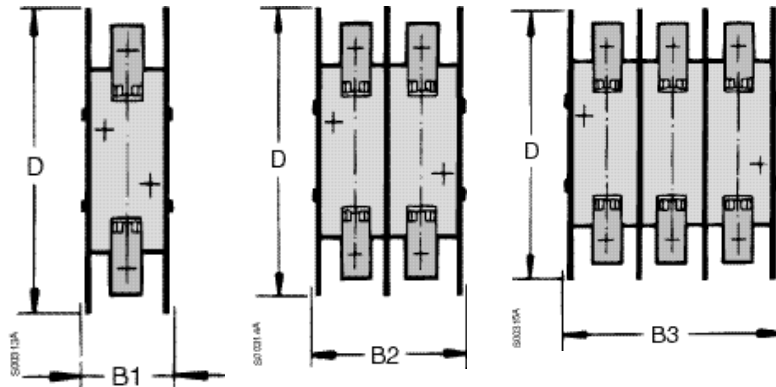

OFAX_S_

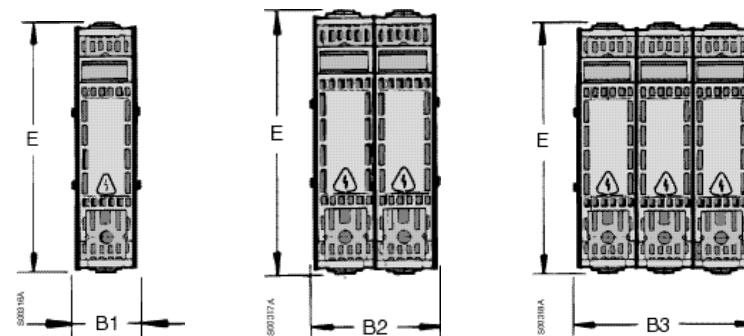

	A1	A2	A3	B1	B2	B3	C	D	E	F	G	H1	H2	H3	ØJ	K	L	M	N	O
OFAX 00_	38	74	109	42	77	112	128	145	148	100 ⁺⁸ ₋₀	25	0	35	70	7.5	35	25.5	2	95	111
OFAX 1_	59.5	114.5	169.5	64	119	174	225	240	250	175 ⁺²⁵ ₋₀	25	30	85	140	10.5	55	41	5	109 ¹⁾	123 ²⁾
OFAX 2_	69.5	134.5	199.5	84	149	214	225	240	250	175 ⁺²⁵ ₋₀	25	30	95	160	10.5	65	41	5	119	133

OFAX 00_

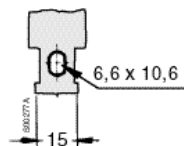

OFAX 00_L

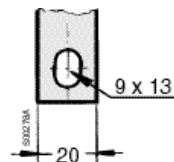

OFAX 1_

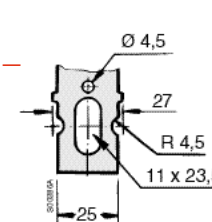

OFAX 2_

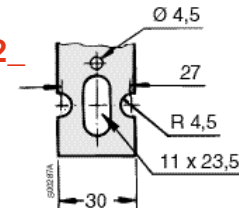

¹⁾ OFAX 1S_ : 119
²⁾ OFAX 1S_ : 133