

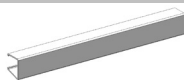





		VS662	
	1		1 x 105mm
	2		1 x ZK416
	3		1 x
	4		1 x ZK333
	5		3 x Ø10mm ² /1250mm
	5		3 x Ø10mm ² /340mm
	6		3 x Ø10mm ² /270mm



1 1x

2 1x

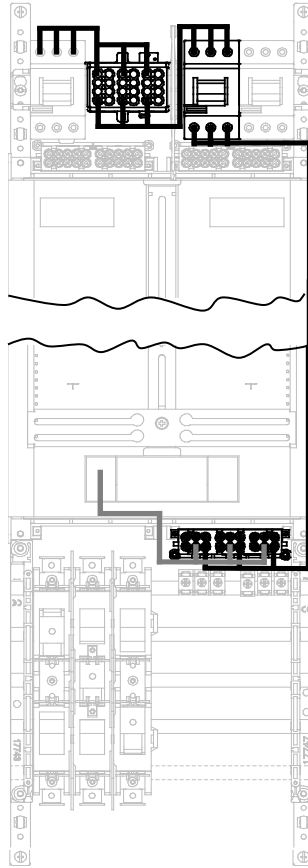
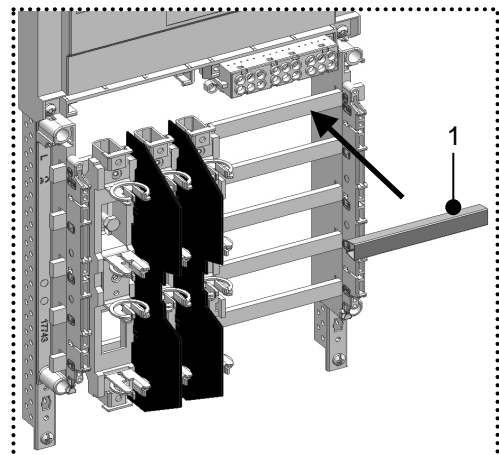
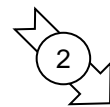
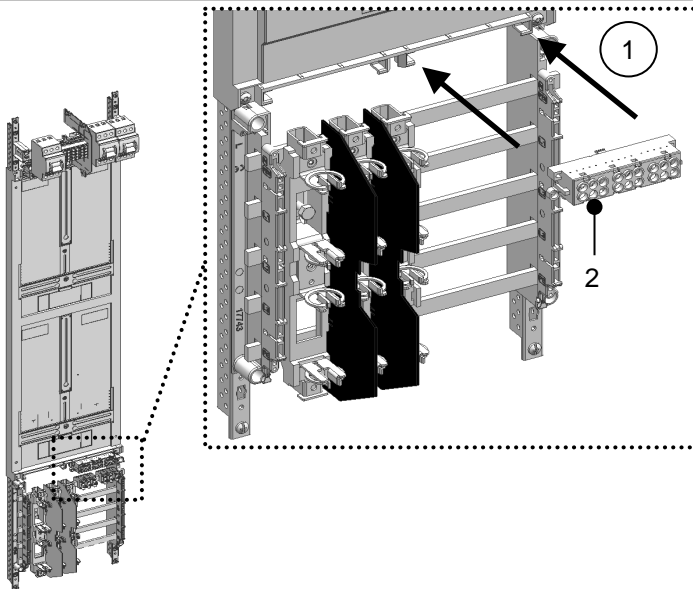

1

- | | | | | | |
|----------|---|----|----------|---|----|
| 3 |  | 1x | 4 |  | 1x |
|----------|---|----|----------|---|----|

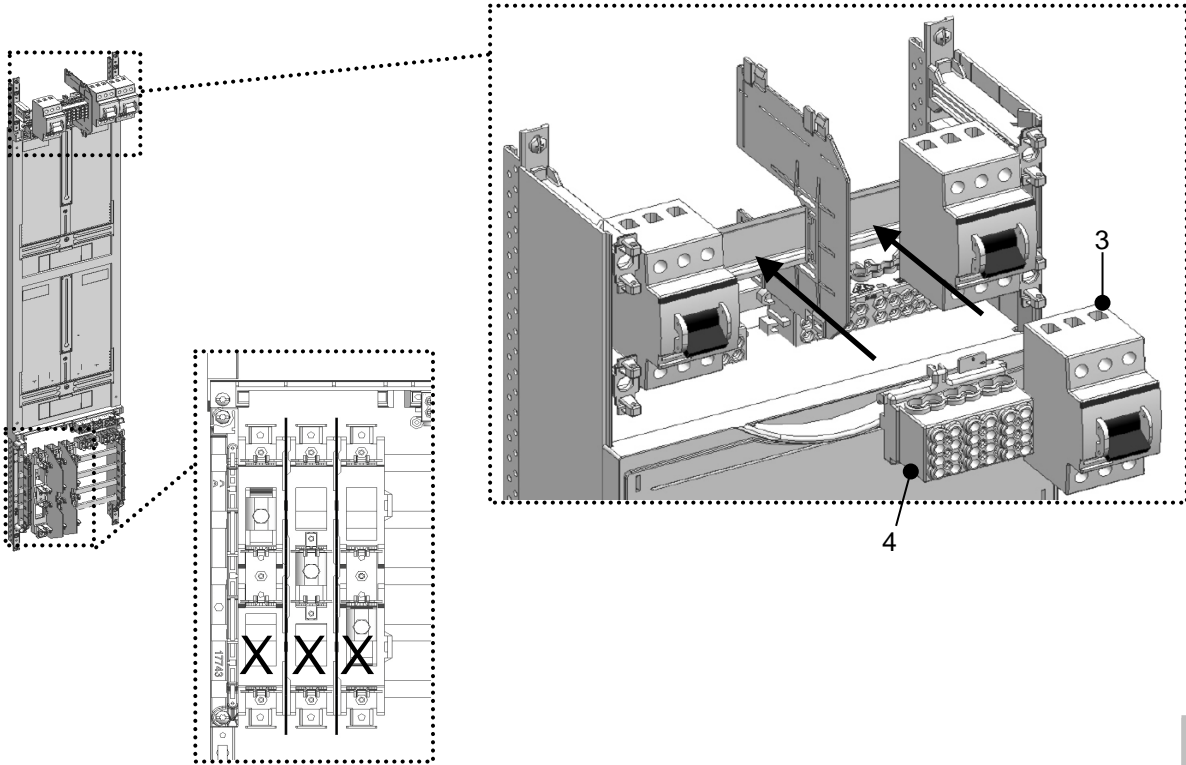

2

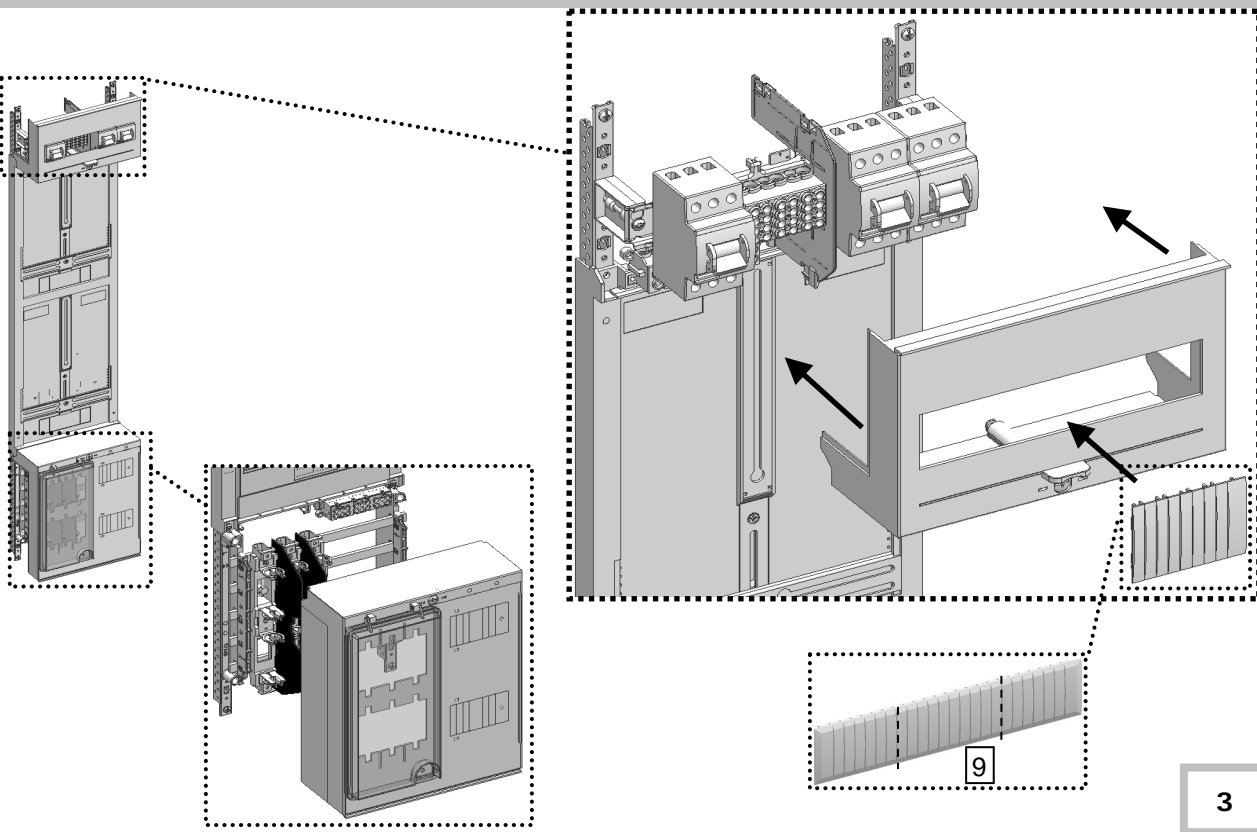
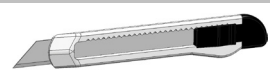

3

- DE** Arbeiten an elektrischen Betriebsmitteln/Anlagen dürfen nur durch eine ausgebildete Elektrofachkraft gemäß DIN 57105 Teil 1 / VDE 0105 Teil 1 / DIN EN 50110-1 durchgeführt werden.
- GB** Only qualified electrical personell according to DIN 57105 part 1 / VDE 0105 part 1 / DIN EN 50110-1 are allowed to work on electrical installations.
- SE** Endast behörig personal enligt DIN 57105 part 1 /VDE 0105 part 1 / DIN EN 50110-1 är tillaten att arbeta med elektriska installationer.
- IT** Solo a personale qualificato, secondo DIN 57105 part 1 / VDE 0105 part 1 / DIN EN 50110-1 é consentito di lavorare su installazioni elettriche.
- FR** Seul le personnel qualifié en electricité selon DIN 57105 part 1 / VDE 0105 part 1 / DIN EN 50110-1 est autorisé à travailler sur installation électrique.
- ES** Sólo electricistas cualificados según norma DIN 57105 part 1 / VDE 0105 part 1 / DIN EN 50110-1 están autorizados a trabajar en instalaciones.
- RU** Согласно DIN 57105, часть 1 / VDE0105, часть 1 / DIN EN 50110-1, на электрических установках разрешается работать только квалифицированному персоналу.