

# ABB Drives

User's Manual  
FlashDrop  
MFDT-01





FlashDrop  
MFDT-01

## **User's Manual**

3AFE68591074 Rev B  
EN  
EFFECTIVE: 5.3.2007



# Table of contents

---

<b>About the manual</b> .....	<b>9</b>
What this chapter contains .....	9
Intended audience .....	9
Additional information for users .....	9
Product training .....	9
Product and service inquiries .....	9
Providing feedback on ABB Drives manuals .....	9
<b>Getting started</b> .....	<b>11</b>
What this chapter contains .....	11
Overview .....	11
Unpacking .....	12
Type designation label .....	12
Compatibility .....	13
Safety instructions .....	13
Installation and commissioning flowchart .....	14
Providing the programming tip with a safety line .....	15
Charging .....	15
Connecting .....	15
Mains electricity supply (AC power source) – charger – base unit .....	15
FlashDrop Control Panel – base unit .....	15
PC – base unit .....	15
FlashDrop – drive .....	16
How to install DrivePM tool, version 1.1 or later .....	16
How to download parameter templates to the FlashDrop .....	17
Storing .....	17
<b>Operation</b> .....	<b>19</b>
What this chapter contains .....	19
Using the FlashDrop for parametrization of drives .....	19
FlashDrop parametrization flowchart .....	21
FlashDrop Control Panel and its operation .....	22
Control panel overview .....	22
Status line .....	23
Operation principles .....	23
How to do common tasks .....	24
Checking the properties and compatibility .....	24
Time & Date mode .....	25
How to set the date and time .....	25
How to adjust the display contrast .....	26
How to view information about the drive connected to the FlashDrop .....	27

---

How to download templates from the Internet .....	28
Parameters mode .....	29
How to initialize (create) a parameter set .....	30
How to upload a parameter set from the drive .....	32
How to view the parameter set information .....	34
How to edit a parameter set .....	35
How to edit the value of a parameter in a set .....	36
How to view and edit the values of changed parameters in a set .....	38
How to edit the visibility of a parameter in a set .....	40
How to edit the visibility of a parameter group in a set .....	41
How to delete a parameter set .....	42
How to download a parameter set to a drive .....	43
How to view information about the FlashDrop .....	44
How to find out the control panel version .....	44
<b>Fault tracing .....</b>	<b>45</b>
What this chapter contains .....	45
Error messages .....	45
<b>Maintenance and hardware diagnostics .....</b>	<b>47</b>
What this chapter contains .....	47
Safety .....	47
Maintenance intervals .....	47
Software .....	47
Base unit .....	48
Battery replacement .....	48
Control panel .....	48
Cleaning .....	48
Battery .....	48
LEDs .....	49
<b>Technical data .....</b>	<b>51</b>
What this chapter contains .....	51
Weight .....	51
Time of use with one charge .....	51
Charge time .....	51
Ambient conditions .....	51
Materials .....	51
Applicable standards .....	51
CE marking .....	51
Dimensions .....	52

---

<b>Glossary</b> .....	<b>53</b>
<b>Additional information</b> .....	<b>55</b>
State diagram of the panel user interface .....	55
Drive ratings table .....	57

---

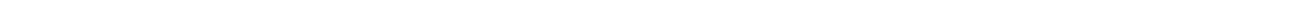



# About the manual

---

## What this chapter contains

This chapter contains information about intended audience of this manual and where the user can get additional information, product and service inquiries, product training and provide feedback on this manual.

## Intended audience

The manual is intended for persons using the FlashDrop. Read it before use.

The manual is written for readers worldwide. Both SI and imperial units are shown.

## Additional information for users

Please visit at FlashDrop product page for more information about FlashDrop.

- Go to the site <http://www.abb.com> with your Internet browser
- Select Our offerings: ABB Product Guide
- -> Motors, Drives and Power Electronics: Drives
- -> Low Voltage AC Drives: either Component drives or General Machinery drives or Standard drives
- Select FlashDrop under the Links title

There you will also find links to FlashDrop product training.

## Product training

For information on ABB product training, navigate to [www.abb.com/drives](http://www.abb.com/drives) and select *Drives – Training courses* on the right pane.

## Product and service inquiries

Address any inquiries about the product to your local ABB representative, quoting the type code and serial number of the unit in question. A listing of ABB sales, support and service contacts can be found by navigating to [www.abb.com/drives](http://www.abb.com/drives) and selecting *Drives – World wide service contacts* on the right pane.

## Providing feedback on ABB Drives manuals

Your comments on our manuals are welcome. Go to [www.abb.com/drives](http://www.abb.com/drives), then select successively *Drives – Document Library – Manuals feedback form* on the right pane.



# Getting started

## What this chapter contains

The chapter describes the construction and installation of the FlashDrop.

## Overview

The FlashDrop is a device used to edit parameter values and visibility and for copying parameters fast to unpowered drives.

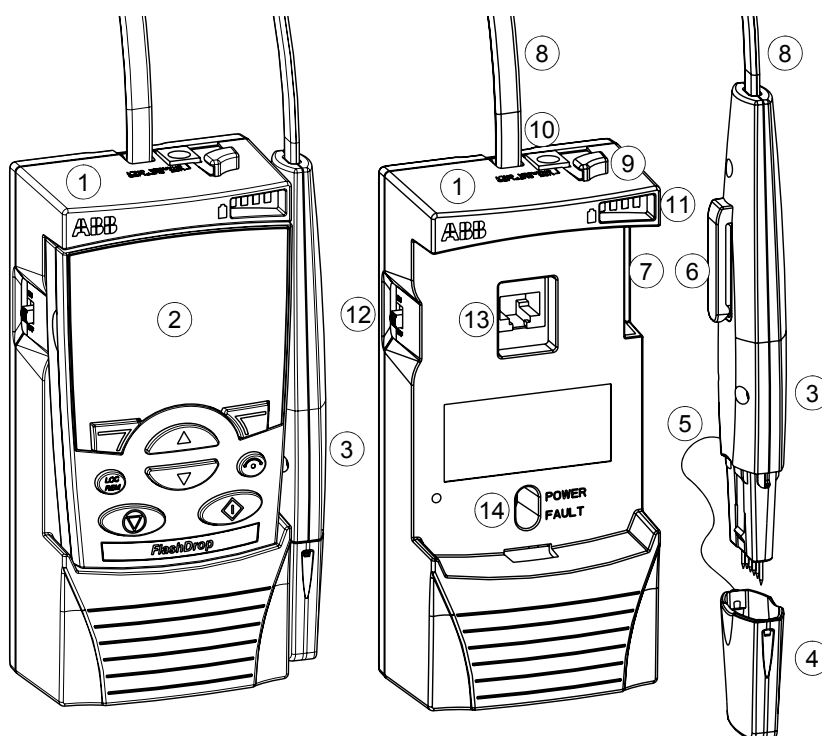

1	Base unit
2	FlashDrop Control Panel
3	Programming tip
4	Programming tip cap
5	Programming tip safety line (not provided)
6	Programming tip clip
7	Programming tip holder

8	Programming tip cable
9	Clip for the programming tip cable
10	Battery charger connection
11	Battery charge level indicators (four LEDs)
12	Power switch
13	FlashDrop Control Panel and PC connection
14	Power OK and Fault LEDs (see <a href="#">LEDs</a> on page 49)

## Unpacking

The delivery package contains the following items:

- FlashDrop (1)
- PC cable (2)
- battery charger (3)
- battery charger mains (AC power) cable with a set of plugs (not shown in the figure) (4)
- user’s manual (5)
- DrivePM CD (6).



Check that there are no signs of damage. Notify the shipper immediately if damaged components are found.

## Type designation label

The type designation label is attached to the back of the base unit. An example label and explanation of the label contents are shown below.

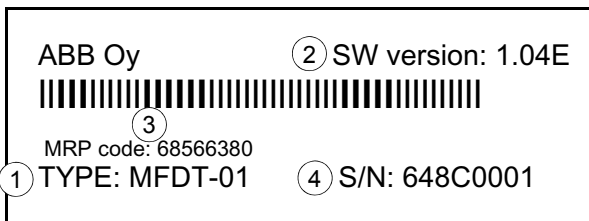

Type designation label

1	Type code
2	Firmware version
3	ABB MRP code
4	Serial number of format YWWRXXXX, where Y: 5...9, A, ... for 2005...2009, 2010, ... WW: 01, 02, 03, ... for week 1, week 2, week 3, ... R: A, B, C ... for product revision number XXXX: Integer starting every week from 0001

## Compatibility

The FlashDrop base unit is compatible with:

- ACS150, drive firmware version 1.31b or later
- ACS350, drive firmware version 2.41a or later
- ACS550-01 and ACH550-01, drive firmware version 3.10b or later. There needs to be a FlashDrop connector in the drive under the control panel.
- DrivePM version 1.1 or later

FlashDrop is non-compatible with older drive firmware versions. The use with older firmware is not allowed.

To find out the firmware version of your drive, see page 27, or check the value of parameter 3301 FW VERSION in the drive.

To find out the firmware and hardware versions of your FlashDrop, see page 44.

To create and edit FlashDrop parameter sets with the DrivePM PC tool or FlashDrop, correct templates are needed. Both DrivePM and FlashDrop templates can be downloaded from the ABB Internet site.

## Safety instructions

Follow these safety instructions when using the FlashDrop.



**WARNING!** Ignoring the following instructions can cause physical injury or death, or damage to the equipment.

- Use the FlashDrop only with an unpowered drive.
  - Do not use the FlashDrop if the cable is broken.
-

## Installation and commissioning flowchart

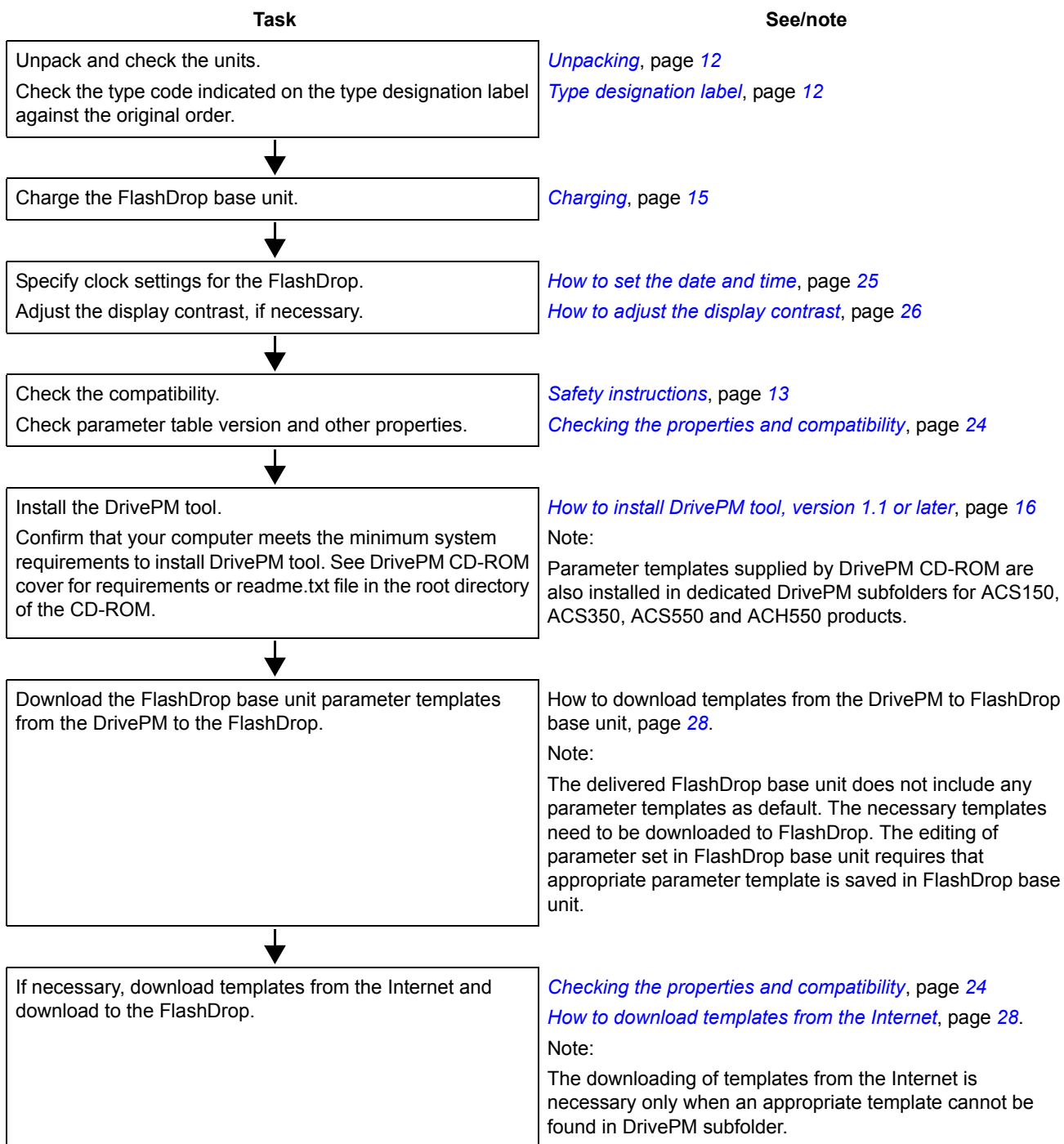

## Providing the programming tip with a safety line

To avoid losing the cap of the programming tip, you can attach a thin line (not provided) to the eyelets of the programming tip.

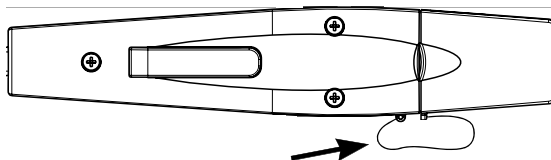

## Charging

Charge the FlashDrop.

---

**Note:** The light refers to the LED on the charger. The LEDs on the FlashDrop base unit are always all lit when the charger is connected and FlashDrop base unit is switched on.

---

When charging the FlashDrop battery, the charger operation is the following:

1. Initialization (orange light)
2. Charging (red light)
3. Finalizing the charge (blinking green light)
4. Battery is charged (green light).

---

**Note:** To charge the battery again, the charger must be removed from the FlashDrop so that the initialization (orange light) is activated in the charger. This is a safety procedure. If the FlashDrop is switched on and charged once, it can not be charged again before it is removed from the charger. You can use the FlashDrop while charging. Please see the charger user's manual for more information.

---

## Connecting

### Mains electricity supply (AC power source) – charger – base unit

Charge the base unit with the provided charger only.

### FlashDrop Control Panel – base unit

The control panel is connected to the base unit with the provided RJ-45 connector.

### PC – base unit

To load parameter sets between the DrivePM PC tool and the FlashDrop, connect your PC to the base unit with the PC cable. Use the provided cable only. The FlashDrop panel has to be removed for PC connection.

### FlashDrop – drive

The FlashDrop is connected to the drive with the programming tip. The drive can be installed or remain in the package.

---

**Note:** The drive must be disconnected from the mains (AC power source) when the FlashDrop is connected.

---

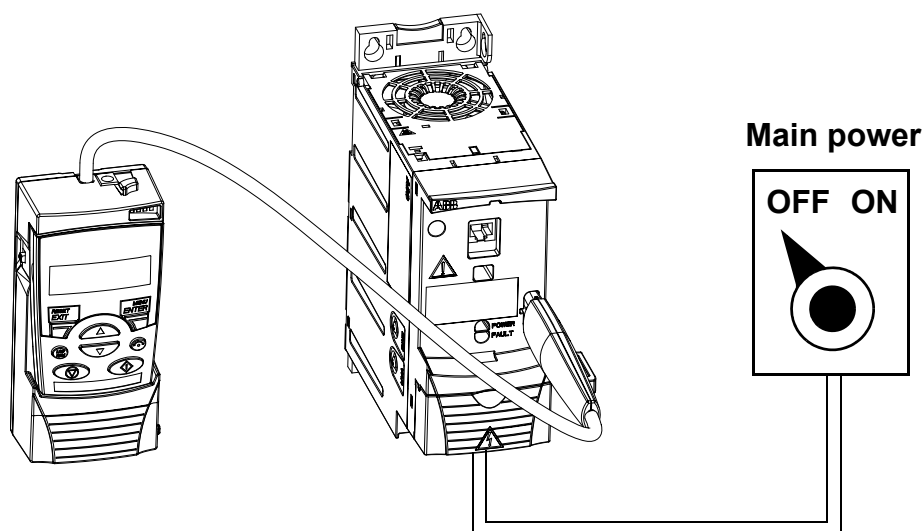

### How to install DrivePM tool, version 1.1 or later

DrivePM (Drive Parameter Manager) is a PC tool for

- 1) creating and editing parameter sets of ACS150, ACS350, ACS550 and ACH550 to be suitable for FlashDrop unit,
- 2) transferring these sets between PC and FlashDrop,
- 3) transferring template files to FlashDrop and
- 4) updating FlashDrop firmware.

DrivePM is designed to run under the Microsoft Windows 2000 or Windows XP operating systems on IBM -compatible PCs.

You should quit all applications before starting the installation. Uninstall any previous version of DrivePM before installing. You must have Administrator privileges to be able to do the installing. Before continuing, kindly remove all files that Windows was not able to remove from DrivePM directory and it's subdirectories.

1. Run the SETUP.EXE from the root directory of this CD.
2. Follow the instructions given by the Installation Wizard.

DrivePM contains online help which can started by pressing 'F1' key or from the 'Help' Menu. Online Help requires MS InternetExplorer 3.0 or later installed in the computer.



You can register your DrivePM/FlashDrop product by filling in and returning the registration form (registration.pdf in the root directory of the DrivePM CD-ROM).

## How to download parameter templates to the FlashDrop

The delivered FlashDrop base unit does not include any parameter templates as default. The necessary templates need to be downloaded to FlashDrop. Parameter templates supplied by DrivePM CD-ROM are installed in dedicated DrivePM subfolders for ACS150, ACS350, ACS550 and ACH550 products. To update the templates to the latest version, see [How to download templates from the Internet](#), page 28. You can have eight parameter templates in total in your FlashDrop simultaneously.

## Storing

When the FlashDrop is not used, keep the capped programming tip in its holder. Wind the cable round the base unit twice, starting from the back of the base unit, and then twist it round the clip on top of the base unit as shown on the figure below.





# Operation

## What this chapter contains

The chapter gives a general view of using the FlashDrop with the DrivePM PC tool to parameterize drives. It describes in detail the FlashDrop Control Panel keys and display fields and how to use the FlashDrop for the drive parametrization. The state diagram of the panel user interface is included in [Additional information](#), page 55. See also [Glossary](#), page 53.

## Using the FlashDrop for parametrization of drives

With the FlashDrop, parameters can be fast copied to unpowered drives, before delivery from the warehouse or during the mechanical installation at the site. Because the FlashDrop is used with an unpowered drive, the drive can remain in the package during the parametrization. The FlashDrop also allows you to hide selected parameters to protect the drive and connected machinery and show only information relevant to the application.

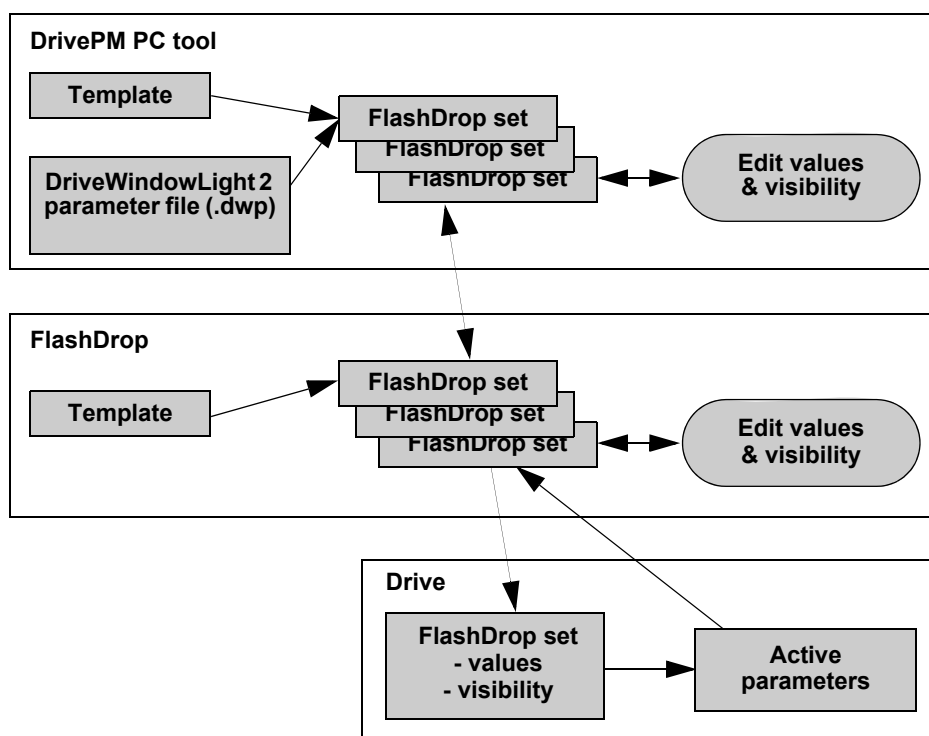

**Note:** The primary way to create and edit parameter sets is by using the DrivePM PC tool. For instructions on using the DrivePM, see the DrivePM help and [How to install DrivePM tool, version 1.1 or later](#), page 16.

Using the FlashDrop to download parameters to drives consists of four phases.

1. Create a FlashDrop parameter set with the DrivePM from a template or a DriveWindowLight parameter file. The name and author in the header information can be edited. See the DrivePM help.

or

Create a FlashDrop parameter set with the FlashDrop Control Panel from a template. The header information of the set contains data about the set, including ID, name, author and creation time. The information is generated automatically. See [How to initialize \(create\) a parameter set](#) on page 30.

or

Upload a parameter set from the drive to the FlashDrop. The header information is generated automatically. See [How to upload a parameter set from the drive](#) on page 32.

2. Edit the set with the FlashDrop Control Panel by giving values to parameters and setting visibilities of parameters and parameter groups. See [How to edit a parameter set](#) on page 35.

or

Edit the set with the DrivePM by giving values to parameters and setting visibilities of parameters and parameter groups. Then download the set to the FlashDrop (FlashDrop menu -> Download To FD). You can continue editing with the FlashDrop Control Panel if necessary. See the DrivePM help.

3. Download the set from the FlashDrop to one or more unpowered drives. Ensure that the drive is disconnected from the mains (AC power source). See [How to download a parameter set to a drive](#) on page 43.

4. Power up the drive to activate the downloaded parameter values and visibilities.

See also the flowchart of the drive parametrization with the FlashDrop on page 21.

---

**Note:** Also parameters 9902 APPLIC MACRO and 1611 PARAMETER VIEW can be made invisible in a FlashDrop parameter set. After the set has been downloaded to a drive and activated, to be able to change these parameters in the drive, e.g. to use a macro, you have to first make them visible with the FlashDrop. Upload the set from the drive to the FlashDrop, make parameters 9902 APPLIC MACRO and 1611 PARAMETER VIEW visible, and then download the set again to the drive. You can switch the drive to use other parameter sets (macros) with parameter 9902 APPLIC MACRO. To reactivate the parameter values defined by the downloaded FlashDrop parameter set, set parameter 9902 to value 31 (FD PAR SET). You can switch the drive to use the default visibilities of the parameters and parameter groups by setting parameter 1611 PARAMETER VIEW to value 0 (DEFAULT). To reactivate the visibilities defined by the downloaded FlashDrop parameter set, set parameter 1611 to value 1 (FLASHDROP).

---

### FlashDrop parametrization flowchart

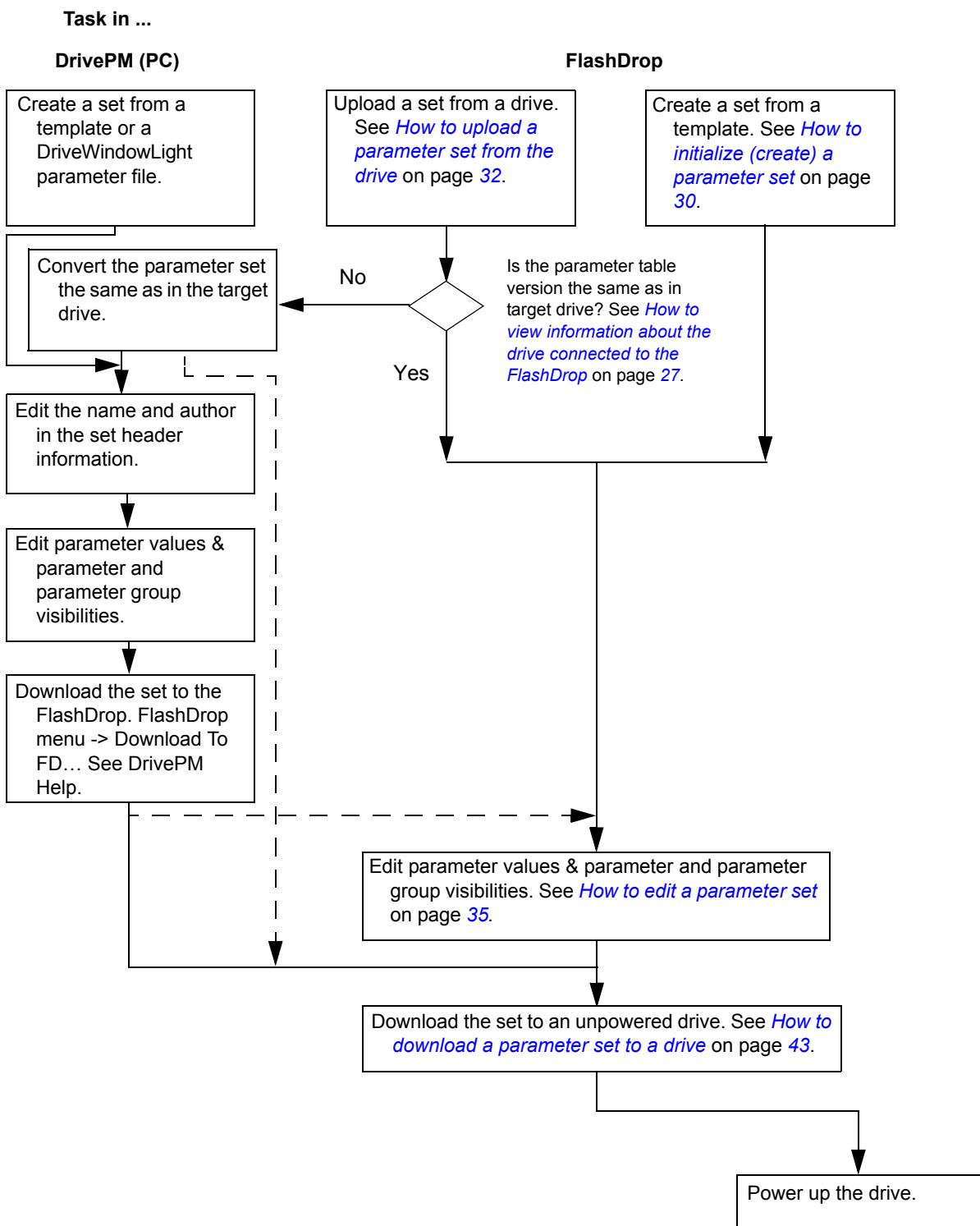

## FlashDrop Control Panel and its operation

The FlashDrop Control Panel is the user interface for using the FlashDrop.

**Note:** It is not possible to use the FlashDrop Control Panel as the control panel for the drive.

### Control panel overview

The following table summarizes the key functions and displays in the FlashDrop Control Panel.

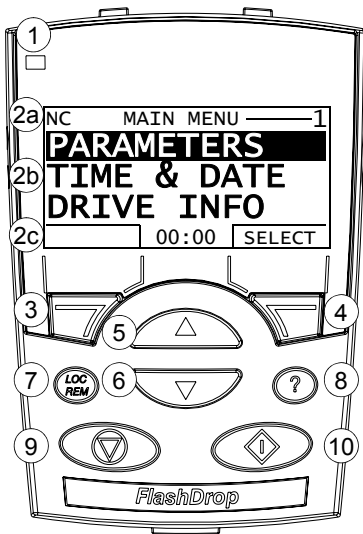

No.	Use
1	Status LED – See <a href="#">LEDs</a> on page 49.
2	LCD display – Divided into three main areas: a. Status line – variable, depending on the mode of operation, see <a href="#">Status line</a> on page 23. b. Center – variable; in general, shows parameter values, menus or lists. c. Bottom line – shows current functions of the two soft keys and, if enabled, the clock display.
3	Soft key 1 – Function depends on the context. The text in the lower left corner of the LCD display indicates the function.
4	Soft key 2 – Function depends on the context. The text in the lower right corner of the LCD display indicates the function.
5	Up – • Scrolls up through a menu or list displayed in the center of the LCD display. • Increments a value if a parameter is selected. Holding the key down changes the value faster.
6	Down – • Scrolls down through a menu or list displayed in the center of the LCD display. • Decrements a value if a parameter is selected. Holding the key down changes the value faster.
7	LOC/REM – Not used.
8	Help – Displays context sensitive information when the key is pressed in the parameter menu. The information displayed describes the parameter currently highlighted in the center of the display.
9	STOP – Not used.
10	START – Downloads the selected set when you are in the set selection display (SET SELECT shown on the status line) or in the Set action menu (SET ACTIONS shown on the status line), see <a href="#">How to download a parameter set to a drive</a> on page 43.

### Status line

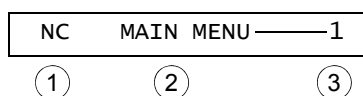

The top line of the LCD display shows the basic status information of the FlashDrop.



No.	Field	Alternatives	Significance
1	Drive connection	NC	Not connected to a drive.
		DRV	Connected to a drive.
2	Panel operation mode		<ul style="list-style-type: none"> <li>• Name of the current mode</li> <li>• Name of the list or menu shown</li> <li>• Name of the operation state, e.g. PAR EDIT.</li> </ul>
3	Number of the selected item		Number of the highlighted item, e.g. mode or parameter group.

### Operation principles

You operate the control panel with the help of menus and keys. The keys include two context-sensitive soft keys, whose current function is indicated by the text shown in the display above each key.

You select an option, e.g. operation mode or parameter, by scrolling the  and  arrow keys until the option is highlighted (in reverse video) and then pressing the relevant soft key. With the right soft key you usually enter a mode, accept an option or save the changes. The left soft key is used to cancel the made changes and return to the previous operation level.

The control panel has the following panel modes: Parameters, Time & Date and Info. The operation in the different modes is described in this chapter.

Initially, the control panel is in the Main menu, where you select the appropriate mode for your task. The status line (see section [Status line](#) on page 23) shows the name of the current menu, mode, item or state.

When an error occurs, the control panel shows the error message. Press  to reset. For more information, see chapter [Fault tracing](#).

### How to do common tasks

The table below lists common tasks, the mode in which you can perform them and the page number where the steps to do the task are described in detail.

Task	Mode	Page
How to set the date and time in the FlashDrop	Time & Date	25
How to adjust the display contrast	Main menu	26
How to check the parameter table versions and other properties of the drive, FlashDrop parameter sets and templates	Info and Parameters	24
How to view information about the drive connected to the FlashDrop	Info	27
How to download templates from the Internet	DrivePM (PC)	28
How to initialize (create) a parameter set	Parameters	30
How to upload a parameter set from the drive	Parameters	32
How to view the parameter set information	Parameters	34
How to edit a parameter set	Parameters	35
How to edit the value of a parameter	Parameters	36
How to view and edit the values of changed parameters	Parameters	38
How to edit the visibility of a parameter	Parameters	40
How to edit the visibility of a parameter group	Parameters	41
How to clear (delete) a parameter set	Parameters	42
How to download a parameter set to a drive	Parameters	43
How to view information about the FlashDrop	Info	44
How to find out the control panel version	At power up	44

### Checking the properties and compatibility

To be able to download a parameter set to a drive, the parameter table version and other properties – drive type and, if specified, rating – of the set must be the same as for the drive.

- To find out the properties of the drive, view the drive information. See [How to view information about the drive connected to the FlashDrop](#) on page 27.
- To find out the properties of a parameter set (other than “[ empty ]”) in the FlashDrop, view its header information. See [How to view the parameter set information](#) on page 34.
- To find out whether a template for particular properties exists in the FlashDrop, start initializing an empty set and check whether any of the shown templates has these properties. See [How to initialize \(create\) a parameter set](#) on page 30.
- If a suitable template does not exist in the FlashDrop, download it from your PC with DrivePM or download the latest version from the internet. See [How to download templates from the Internet](#) on page 28.



































## Time & Date mode







In the Time & Date mode, you can specify clock settings for the FlashDrop.

The control panel contains a battery to ensure the function of the clock when the control panel is not powered by the base unit.

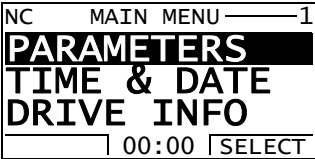





### How to set the date and time

Step	Action	Display
1.	If you are not in the Main menu, press  repeatedly until you get there.	<pre> NC  MAIN MENU — 1 PARAMETERS TIME &amp; DATE DRIVE INFO 00:00   SELECT           </pre>
2.	Go to the Time & Date mode by selecting TIME & DATE on the menu with keys  and  , and pressing  .	<pre> NC  TIME &amp; DATE — 1 CLOCK VISIBILITY TIME FORMAT DATE FORMAT SET TIME SET DATE EXIT   00:00   SELECT           </pre>
3.	<ul style="list-style-type: none"> <li>To set the visibility of the clock on the bottom line of the LCD display, select CLOCK VISIBILITY on the menu and press . Select the preferred setting with keys  and , and press .</li> <li>To set the time format of the clock, select TIME FORMAT on the menu and press . Select the preferred setting with keys  and , and press .</li> <li>To set the format of the date, select DATE FORMAT on the menu and press . dd means the day, mm the month and yy or yyyy the year. Select the preferred setting with keys  and , and press .</li> <li>To set the time, select SET TIME on the menu and press . Specify the hours with keys  and , and press . Then specify the minutes. Press  to save or  to cancel your changes.</li> <li>To set the date, select SET DATE on the menu and press . Specify the first part of the date (day or month depending on the date format) with keys  and , and press . Repeat for the second part. After specifying the year, press . To cancel your changes, press .</li> </ul>	<pre> NC  CLOCK VISIB — Show clock Hide clock CANCEL   00:00   SELECT           </pre> <pre> NC  TIME FORMAT — 24-hour 12-hour CANCEL   00:00   SELECT           </pre> <pre> NC  TIME FORMAT — dd.mm.yy mm/dd/yy dd.mm.yyyy mm/dd/yyyy CANCEL   00:00   OK           </pre> <pre> NC  SET TIME — 15:41 CANCEL   00:00   OK           </pre> <pre> NC  SET DATE — 19.03.06 CANCEL   00:00   OK           </pre>
	<ul style="list-style-type: none"> <li>To set the used daylight saving, select DAYLIGHT SAVING on the menu and press . Select your area or off with keys  and , and press .</li> </ul>	<pre> NC  TIME FORMAT — Off EU US Australia1:NSw,Vict.. Australia2:Tasmania.. CANCEL   00:00   SELECT           </pre>

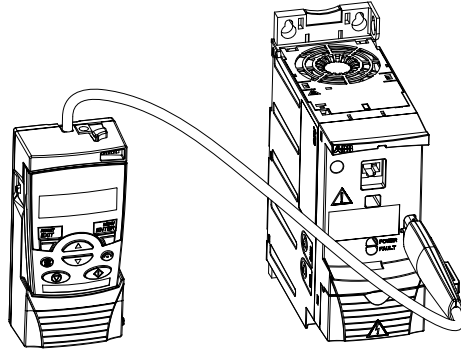
*How to adjust the display contrast*



Step	Action	Display
1.	If you are not in the Main menu, press  repeatedly until you get there.	 <p>NC MAIN MENU — 1  <b>PARAMETERS</b>                  TIME &amp; DATE                  DRIVE INFO                  00:00   SELECT</p>
2.	<ul style="list-style-type: none"> <li>• To increase the contrast, press keys  and  simultaneously.</li> <li>• To decrease the contrast, press keys  and  simultaneously.</li> </ul> <p>The contrast setting is not saved. The default contrast setting is resumed each time the FlashDrop is started up.</p>	 <p>NC MAIN MENU — 1  <b>PARAMETERS</b>                  TIME &amp; DATE                  DRIVE INFO                  00:00   SELECT</p>

### How to view information about the drive connected to the FlashDrop

Step	Action	Display
1.	If you are not in the Main menu, press  repeatedly until you get there.	<pre> NC  MAIN MENU — 1 PARAMETERS TIME &amp; DATE DRIVE INFO   00:00   SELECT </pre>
2.	<p>Ensure that the drive is disconnected from the mains (AC power source).</p> <p>Insert the programming tip in the FlashDrop connection of the drive. Depending on the drive type, the connection is located on the front of the drive or in the control panel recess.</p> <p>The top left corner of the FlashDrop display shows now DRV indicating that the FlashDrop is connected to a drive.</p> 	<pre> DRV  MAIN MENU — 1 PARAMETERS TIME &amp; DATE DRIVE INFO   00:00   SELECT </pre>
3.	<p>Go to the Drive Info mode by selecting DRIVE INFO on the menu with keys  and , and pressing . The display shows the following information about the drive:</p> <p>DRIVE TYPE:                    type of the drive</p> <p>PARAMETER TABLE:        parameter table version, which must match the version of the sets that are downloaded to the drive.</p> <p>DRIVE RATING:                rating of the drive. See <a href="#">Drive ratings table</a> on page 57 for more information.</p> <p>FIRMWARE:                    firmware version of the drive</p> <p>AREA:                         EUR or US, selects appropriate defaults and units</p> <p>You can scroll the information with keys  and .</p>	<pre> DRV  DRIVE INFO — DRIVE TYPE: ACS350 PARAMETER TABLE: 241A hex DRIVE RATING: EXIT   00:00   </pre> <pre> DRV  DRIVE INFO — 2A41 hex FIRMWARE: 241A hex AREA: EUR EXIT   00:00   </pre>
4.	Return to the Main menu by pressing  .	<pre> DRV  MAIN MENU — 1 PARAMETERS TIME &amp; DATE DRIVE INFO   00:00   SELECT </pre>

### How to download templates from the Internet

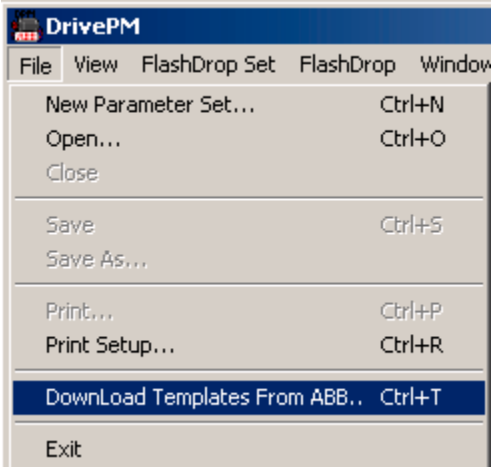
If the FlashDrop and DrivePM do not have suitable templates for the drive where you intend to download the parameter set (see section [Checking the properties and compatibility](#) on page 24), you have to download the correct templates from the Internet with DrivePM.

Step	Action
1.	<p>Go to the FlashDrop product page with your Internet Browser:</p> <ul style="list-style-type: none"> <li>Go to the site <a href="http://www.abb.com">http://www.abb.com</a> with your Internet browser</li> <li>Select Our offerings: ABB Product Guide</li> <li>-&gt; Motors, Drives and Power Electronics: Drives</li> <li>-&gt; Low Voltage AC Drives: either Component drives or General Machinery drives or Standard drives</li> <li>Select FlashDrop under the Links title</li> </ul> <p>Or select File menu -&gt; Download Templates from ABB... in DrivePM tool.</p>
	
2.	Download the template package to the PC where you are running the DrivePM, in folder Program Files / DriveWare / DrivePM.
3.	<p>Extract the package.</p> <p>The DrivePM templates are now visible in the DrivePM PC tool. Download next the FlashDrop base unit templates to the FlashDrop, as instructed in steps 4. and 5.</p>
4.	<p>Remove the control panel from the FlashDrop. Connect the Flash Drop base unit to the PC with the provided data cable OPCA-02 by plugging it to the control panel / PC connection in the control panel recess of the FlashDrop base unit and to the COM port of the PC.</p>
	
5.	<p>Download the FlashDrop base unit templates from the DrivePM to the FlashDrop:</p> <ul style="list-style-type: none"> <li>Select the Download FlashDrop Template option from the FlashDrop menu. The FlashDrop Template Download dialog box is displayed.</li> <li>Select a FlashDrop template by clicking Browse under Source.</li> <li>Select the destination file set of the connected FlashDrop device from the FlashDrop Template Location drop-down list under Destination.</li> <li>Click OK.</li> </ul>



















**Parameters mode**

In the Parameters mode, you can:

- download a parameter set to a drive
- initialize (create) a parameter set
- upload a parameter set from the drive
- view the header information of a parameter set
- edit a parameter set
  - edit values of parameters for the active parameter set
  - edit values of parameters for the user sets (user set1-3 and override set)
  - view and edit values of changed parameters in the set
  - edit the visibilities of parameters in the set
  - edit the visibilities of whole parameter groups in the set
- clear (delete) a parameter set.

### How to initialize (create) a parameter set

Create the parameter set by using a template compatible with the drive. See [Checking the properties and compatibility](#), page 24. See also [How to view information about the drive connected to the FlashDrop](#), page 27 and [How to download templates from the Internet](#), page 28.











Step	Action	Display
1.	If you are not in the Main menu, press  repeatedly until you get there.	<pre> NC  MAIN MENU——1 PARAMETERS TIME &amp; DATE DRIVE INFO 00:00   SELECT           </pre>
2.	Go to the Parameters mode by selecting PARAMETERS on the menu with keys  and  , and pressing  .	<pre> NC  SETS——1 1. Demo 2. Varying speed 3. 2 Cycles DI2 FlashDrop set 04 [ empty ] EXIT   00:00   SELECT           </pre>
3.	Select an empty set (“[ empty ]”) on the menu with keys  and  , and start its initialization by pressing  .	<pre> NC  SETS——5 2. Varying speed 3. 2 Cycles DI2 FlashDrop set 04 [ empty ] 6. Traverse Ctrl EXIT   00:00   INIT           </pre>
4.	Select “Create a new set” on the menu with keys  and  , and continue by pressing  .	<pre> NC  ——5 Select init mode Create a new set Upload from drive CANCEL   00:00   SELECT           </pre>
5.	Select the appropriate template with keys  and  . The properties of each template are shown below it:  Drive type: type of the drive Area: EUR or US, selects appropriate defaults and units Param table: parameter table version of the set. Control mode: scalar or vector mode. All parameter sets created by FlashDrop will have the same control mode.  Press  .	<pre> NC  SET INIT—— Select Template 01 Drive type: ACS350 Area: EUR Param table: 230A Control mode: SCALAR CANCEL   00:00   SELECT           </pre>
6.	Select the drive rating with keys  and  if the set parameters depend on the rating, otherwise select “Not defined”. Press  .	<pre> NC  SET INIT—— Drive rating 2A42 CANCEL   00:00   SELECT           </pre>
7.	Select the default visibility for parameters and parameter groups with keys  and  . Press  .	<pre> NC  SET INIT—— Select visibility visible as default CANCEL   00:00   SELECT           </pre>

Step	Action	Display
8.	<p>Message "Saving parameter set" is shown. If the saving succeeds, the panel LED is green for a moment and message "Set save OK" is shown briefly.</p> <p>The FlashDrop assigns automatically the following header information to the set:</p> <p>Name: FLASHDROP SET nn, where nn is the index of the set in the FlashDrop</p> <p>Time and date: current time and date</p> <p>Author: text "FLASHDROP".</p> <p>The panel returns to the set selection display and shows the name of the initialized set.</p>	<pre> NC   SET SELECT-----5 2. Varying speed 3. 2 Cycles BI2 FLASHDROP SET 04 FLASHDROP SET 05 6. Traverse Ctrl EXIT   00:00   SELECT                     </pre>

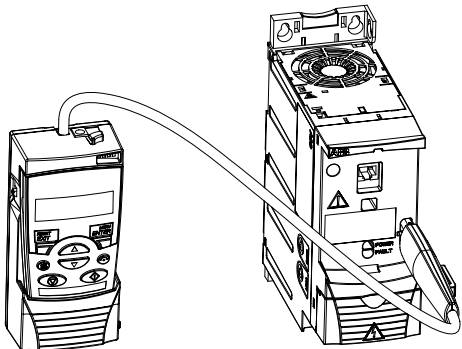





### How to upload a parameter set from the drive

You must have a template compatible with the drive you are uploading the set from. For checking the drive information, see [How to view information about the drive connected to the FlashDrop](#) on page 27.

If there is no template with the properties you need, you have to download the correct template from your PC. The latest templates can be downloaded from the Internet according to the instructions in [How to download templates from the Internet](#) on page 28.

Step	Action	Display
1.	If you are not in the Main menu, press  repeatedly until you get there.	<pre> NC  MAIN MENU-----1 <b>PARAMETERS</b> <b>TIME &amp; DATE</b> <b>DRIVE INFO</b> -----   00:00  SELECT           </pre>
2.	Go to the Parameters mode by selecting PARAMETERS on the menu with keys  and  , and pressing  .	<pre> NC  SETS-----1 <b>1. Demo</b> 2. Varying speed 3. 2 Cycles DI2 FlashDrop set 04 [ empty ]  EXIT   00:00  SELECT           </pre>
3.	<p>Ensure that the drive is disconnected from the mains (AC power source).</p> <p>Insert the programming tip in the FlashDrop connection of the drive. Depending on the drive type, the connection is located on the front of the drive or in the control panel recess.</p> <p>The top left corner of the FlashDrop display shows now DRV indicating that the FlashDrop is connected to a drive.</p> 	<pre> DRV SETS-----1 <b>1. Demo</b> 2. Varying speed 3. 2 Cycles DI2 FlashDrop set 04 [ empty ]  EXIT   00:00  SELECT           </pre>
4.	Select an empty set (“[ empty ]”) on the menu with keys  and  , and start its initialization by pressing  .	<pre> DRV SETS-----5 2. Varying speed 3. 2 Cycles DI2 FlashDrop set 04   empty   <b>6. Traverse Ctrl</b>  EXIT   00:00  INIT           </pre>
5.	Select “Upload from drive” on the menu with keys  and  , and continue by pressing  .	<pre> DRV -----5 Select init mode Create a new set <b>Upload from drive</b>  CANCEL  00:00  SELECT           </pre>















Step	Action	Display
6.	Select the drive rating with keys  and  if the set parameters depend on the rating, otherwise select "Not defined". Press  . See <a href="#">Drive ratings table</a> on page 57 for more information.	<pre> DRV UPLOAD SET----- Drive rating 2A42 ----- CANCEL   00:00   SELECT           </pre>
7.	Select the default visibility for parameters and parameter groups with keys  and  . Press  .	<pre> DRV UPLOAD SET----- select visibility visible ----- CANCEL   00:00   SELECT           </pre>
8.	<p>Message "Uploading parameter set" is shown. Control modes of the user sets will be copied from the drive. If a user set is empty the control mode of the active set will be applied.</p> <p>If the saving succeeds, the panel LED is green for a moment and message "Upload OK" is shown briefly.</p> <p>The FlashDrop assigns the following header information to the set:</p> <p>Name: FLASHDROP SET nn, where nn is the index of the set in the FlashDrop</p> <p>Time and date: current time and date</p> <p>Author: text "FLASHDROP".</p> <p>The panel returns to the set selection display and shows the name of the initialized set.</p>	<pre> DRV SETS-----5 2. Varying speed 3. 2 Cycles DI2 FLASHDROP SET 04 FLASHDROP SET 05 6. Traverse Ctrl ----- EXIT   00:00   SELECT           </pre>

---











**Note:** You can only download the uploaded set to a drive with the same parameter table version. Otherwise the uploaded set must be converted to a correct parameter table version using the DrivePM PC tool. See the DrivePM help for more information.

---















### How to view the parameter set information











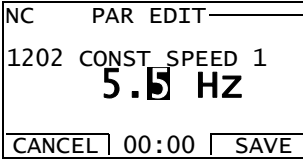

Step	Action	Display
1.	If you are not in the Main menu, press  repeatedly until you get there.	<pre> NC  MAIN MENU  —1 PARAMETERS TIME &amp; DATE DRIVE INFO   00:00   SELECT </pre>
2.	Go to the Parameters mode by selecting PARAMETERS on the menu with keys  and  , and pressing  .	<pre> NC  SETS  —1 1. Demo 2. Varying speed 3. 2 Cycles DI2 FlashDrop set 04 [ empty ] EXIT   00:00   SELECT </pre>
3.	Select the parameter set with keys  and  , and press  .	<pre> NC  SET ACTIONS —1 DOWNLOAD INFO EDIT DELETE EXIT   00:00   SELECT </pre>
4.	Select INFO with keys  and  , and press  . The display shows the following information about the parameter set:  SET INDEX:                   index of the set in the FlashDrop SET NAME                    name of the set, free text edited in the DrivePM or created automatically when initialized in the FlashDrop (of format "FlashDrop set nn", where nn is the set index)  TIME:                        creation time of the set DATE:                        creation date of the set AUTHOR:                     creator of the set, free text edited in the DrivePM or created automatically when initialized in the FlashDrop ("FlashDrop")  DRIVE RATING:               rating of the drive DRIVE TYPE:                 type of the drive AREA:                        EUR or US, selects appropriate defaults and units CONTROL MODE:              scalar or vector mode PARAMETER TABLE VER     parameter table version of the set.  You can scroll the information with keys  and  .	<pre> NC  PAR SET INFO — SET INDEX: 4 SET NAME: FlashDrop set 04 TIME: EXIT   00:00   </pre> <pre> NC  PAR SET INFO — 12:23:50 DATE: 12.03.2006 AUTHOR: FlashDrop EXIT   00:00   </pre> <pre> NC  PAR SET INFO — DRIVE RATING: 2A42 DRIVE TYPE: ACS350 AREA: EXIT   00:00   </pre> <pre> NC  PAR SET INFO — EUR CONTROL MODE: SCALAR PARAMETER TABLE VER: 230A EXIT   00:00   </pre>
5.	After reading the text, return to the previous display by pressing  .	<pre> NC  SET ACTIONS —2 DOWNLOAD INFO EDIT DELETE EXIT   00:00   SELECT </pre>

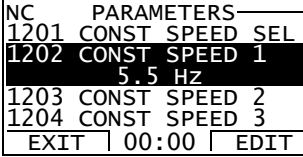
### How to edit a parameter set

Step	Action	Display																														
1.	If you are not in the Main menu, press  repeatedly until you get there.	<pre> NC  MAIN MENU——1 PARAMETERS TIME &amp; DATE DRIVE INFO   00:00  SELECT </pre>																														
2.	Go to the Parameters mode by selecting PARAMETERS on the menu with keys  and  , and pressing  .	<pre> NC  SETS——1 1. Demo 2. Varying speed 3. 2 Cycles DI2 FlashDrop set 04 [ empty ] EXIT   00:00  SELECT </pre>																														
3.	Select the parameter set with keys  and  , and press  .	<pre> NC  SET ACTIONS——1 DOWNLOAD INFO EDIT DELETE EXIT   00:00  SELECT </pre>																														
4.	<p>Select EDIT with keys  and , and press .</p> <ul style="list-style-type: none"> <li>To edit the values of parameters, see page 36.</li> <li>To edit the values of parameters whose values have been changed before (using a list that shows changed parameters only), see page 38.</li> <li>To edit the visibility of parameters, see page 40.</li> <li>To edit the visibility of parameter groups, see page 41.</li> </ul> <p><b>Note:</b> The visible menu choices depends on the type of the drive to which the set is for. See the following table for a list of the sets supported by the drives</p> <table border="1" data-bbox="335 1220 1093 1523"> <thead> <tr> <th></th> <th>ACS150</th> <th>ACS350</th> <th>ACS550</th> <th>ACH550</th> </tr> </thead> <tbody> <tr> <td>Active parameters</td> <td>X</td> <td>X</td> <td>X</td> <td>X</td> </tr> <tr> <td>User set 1</td> <td></td> <td>X</td> <td>X</td> <td>X</td> </tr> <tr> <td>User set 2</td> <td></td> <td>X</td> <td>X</td> <td>X</td> </tr> <tr> <td>User set 3</td> <td></td> <td>X</td> <td></td> <td></td> </tr> <tr> <td>Override set</td> <td></td> <td></td> <td></td> <td>X</td> </tr> </tbody> </table>		ACS150	ACS350	ACS550	ACH550	Active parameters	X	X	X	X	User set 1		X	X	X	User set 2		X	X	X	User set 3		X			Override set				X	<pre> NC  EDIT MENU——1 ACTIVE SET PARAMETER VISIBILITY GROUP VISIBILITY USER SET1 USER SET2 EXIT   00:00  SELECT </pre> <pre> NC  EDIT MENU——6 USER SET3 OVERRIDE SET EXIT   00:00  SELECT </pre>
	ACS150	ACS350	ACS550	ACH550																												
Active parameters	X	X	X	X																												
User set 1		X	X	X																												
User set 2		X	X	X																												
User set 3		X																														
Override set				X																												





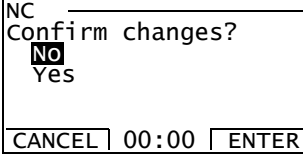







### How to edit the value of a parameter in a set







Step	Action	Display
1.	If you are not in the Edit menu, see <a href="#">How to edit a parameter set</a> on page 35 for instructions.	<pre> NC  EDIT MENU-----1 ACTIVE SET PARAMETER VISIBILITY GROUP VISIBILITY USER SET1 USER SET2 EXIT   00:00   SELECT </pre>
2.	Select the set (active set, user set1, user set2 ...) you want to edit with keys  and  , and press  .	<pre> NC  EDIT MENU ----- PARAMETERS CHANGED PARAMETERS  CANCEL   00:00   SELECT </pre>
3.	Select the PARAMETERS with keys  and  , and press  .	<pre> NC ----- Show hidden? NO Yes  CANCEL   00:00   ENTER </pre>
4.	If you want to see all parameters in the FlashDrop while editing, including those that are hidden in the set, select Yes with key  , otherwise leave No selected. Press  . <b>Note:</b> Selecting Yes does not change the visibility of the hidden parameters. Hidden parameters and parameter groups are indicated with an asterisk (*).	<pre> NC  GROUPS-----01 01 OPERATING DATA 03*FB ACTUAL SIGNALS 04 FAULT HISTORY 10 START/STOP/DIR 11 REFERENCE SELECT EXIT   00:00   SELECT </pre>
5.	Select the parameter group with keys  and  .  Press  .	<pre> NC  GROUPS-----12 04 FAULT HISTORY 10 START/STOP/DIR 11 REFERENCE SELECT 12 CONSTANT SPEEDS 13 ANALOGUE INPUTS EXIT   00:00   SELECT  NC  PARAMETERS----- 1201 CONST SPEED SEL DI3,4 1202 CONST SPEED 1 1203 CONST SPEED 2 1204 CONST SPEED 3 EXIT   00:00   EDIT </pre>
6.	Select the parameter with keys  and  . The current value of the selected parameter is shown below it.  Press  .	<pre> NC  PARAMETERS----- 1201 CONST SPEED SEL 1202 CONST SPEED 1 5.0 Hz 1203 CONST SPEED 2 1204 CONST SPEED 3 EXIT   00:00   EDIT  NC  PAR EDIT----- 1202 CONST SPEED 1 5.0 Hz  CANCEL   00:00   SAVE </pre>

Step	Action	Display
7.	Specify a new value for the parameter with keys  and  . Pressing the key once increments or decrements the value. Holding the key down changes the value faster. Pressing the keys simultaneously replaces the displayed value with the default value.	
8.	<ul style="list-style-type: none"> <li>To save the new value, press .</li> <li>To cancel the new value and keep the original, press .</li> </ul>	
9.	When you exit the Edit menu of the parameter set, you are requested to confirm your changes. <ul style="list-style-type: none"> <li>To cancel the new values and keep the original, select No with keys  and , and press .</li> <li>To save the new values, select Yes with keys  and , and press . Message "Saving parameter set" is shown briefly. If the saving succeeds, the panel LED is green for a moment and message "Set save OK" is shown before returning the main Edit menu.</li> <li>To return to the previous menu, press .</li> </ul>	







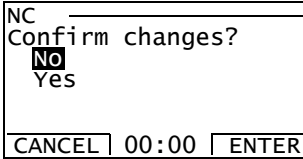









### How to view and edit the values of changed parameters in a set

This option is a shortcut to those parameters that have already been modified.

Step	Action	Display
1.	If you are not in the Edit menu, see <a href="#">How to edit a parameter set</a> on page 35 for instructions.	<pre> NC  EDIT MENU  1 ACTIVE SET PARAMETER VISIBILITY GROUP VISIBILITY USER SET1 USER SET2 EXIT  00:00  SELECT           </pre>
2.	Select the set (active set, user set1, user set2 ...) you want to edit with keys  and  , and press  .	<pre> NC  EDIT MENU  1 PARAMETER CHANGED PARAMETERS  CANCEL  00:00  SELECT           </pre>
3.	Select CHANGED PARAMETERS with keys  and  , and press  .	<pre> NC  CHANGED PARS 1201 CONST SPEED SEL DI3,4 1202 CONST SPEED 1 1301 MINIMUM AI1 1302 MAXIMUM AI1 EXIT  00:00  EDIT           </pre>
4.	Select the parameter with keys  and  . The current value of the selected parameter is shown below it.  Press  .	<pre> NC  CHANGED PARS 1201 CONST SPEED SEL 1202 CONST SPEED 1 5.5 Hz 1301 MINIMUM AI1 1302 MAXIMUM AI1 EXIT  00:00  EDIT           </pre> <pre> NC  PAR EDIT 1202 CONST SPEED 1 5.5 Hz CANCEL  00:00  SAVE           </pre>
5.	Specify a new value for the parameter with keys  and  . Pressing the key once increments or decrements the value. Holding the key down changes the value faster. Pressing the keys simultaneously replaces the displayed value with the default value.	<pre> NC  PAR EDIT 1202 CONST SPEED 1 5.8 Hz CANCEL  00:00  SAVE           </pre>
6.	<ul style="list-style-type: none"> <li>To save the new value, press .</li> <li>To cancel the new value and keep the original, press .</li> </ul>	<pre> NC  CHANGED PARS 1202 CONST SPEED 1 5.8 Hz 1301 MINIMUM AI1 1302 MAXIMUM AI1 1401 RELAY OUTPUT EXIT  00:00  EDIT           </pre>

Step	Action	Display
7.	<p>When you exit the Edit menu of the parameter set, you are requested to confirm your changes.</p> <ul style="list-style-type: none"> <li>To cancel the new values and keep the original, select No with keys  and , and press .</li> <li>To save the new values, select Yes with keys  and , and press . Message "Saving parameter set" is shown briefly. If the saving succeeds, the panel LED is green for a moment and message "Set save OK" is shown before returning to the main Edit menu.</li> <li>To return to the previous menu, press .</li> </ul>	















### How to edit the visibility of a parameter in a set

Step	Action	Display
1.	If you are not in the Edit menu, see <a href="#">How to edit a parameter set</a> on page 35 for instructions.	<pre> NC EDIT MENU-----1 ACTIVE SET PARAMETER VISIBILITY GROUP VISIBILITY USER SET1 USER SET2 EXIT   00:00   SELECT </pre>
2.	Select PARAMETER VISIBILITY with keys  and  , and press  . Message "Opening parameter set" is shown briefly.	<pre> NC GROUPS-----01 01 OPERATING DATA 04 FAULT HISTORY 10 START/STOP/DIR 11 REFERENCE SELECT 12 CONSTANT SPEEDS EXIT   00:00   SELECT </pre>
3.	Select the parameter group with keys  and  . Only visible groups are shown. Press  .	<pre> NC PARAMETERS----- 1201 CONST SPEED SEL Visible 1202 CONST SPEED 1 1203 CONST SPEED 2 1204*CONST SPEED 3 EXIT   00:00   HIDE </pre>
4.	Select the parameter with keys  and  . The current visibility (Visible/Hidden) of the selected parameter is shown below it. Hidden parameters are indicated with an asterisk (*).	<pre> NC PARAMETERS----- 1201 CONST SPEED SEL 1202 CONST SPEED 1 Visible 1203 CONST SPEED 2 1204*CONST SPEED 3 EXIT   00:00   HIDE </pre>
5.	<ul style="list-style-type: none"> <li>To hide a visible parameter, press .</li> <li>To show a hidden parameter, press .</li> </ul>	<pre> NC PARAMETERS----- 1201 CONST SPEED SEL 1202*CONST SPEED 1 Hidden 1203 CONST SPEED 2 1204*CONST SPEED 3 EXIT   00:00   SHOW </pre>
6.	<p>When you exit the Groups menu, you are requested to confirm your changes.</p> <ul style="list-style-type: none"> <li>To cancel the new values and keep the original, select No with keys  and , and press .</li> <li>To save the new values, select Yes with keys  and , and press . Message "Saving parameter set" is shown briefly. If the saving succeeds, the panel LED is green for a moment and message "Set save OK" is shown before returning the main Edit menu.</li> <li>To return to the previous menu, press .</li> </ul>	<pre> NC ----- Confirm changes? NO Yes CANCEL   00:00   ENTER </pre>

















**Note:** The visibility definitions are common to active parameter set and user sets.



### How to edit the visibility of a parameter group in a set

Step	Action	Display
1.	If you are not in the Edit menu, see <a href="#">How to edit a parameter set</a> on page 35 for instructions.	<pre> NC EDIT MENU——6 ACTIVE SET PARAMETER VISIBILITY GROUP VISIBILITY USER SET1 USER SET2 EXIT   00:00   SELECT </pre>
2.	Select GROUP VISIBILITY with keys  and  , and press  . Message “Opening parameter set” is shown briefly.	<pre> NC GROUPS 01 OPERATION DATA   visible 03*FB ACTUAL SIGNALS 04 FAULT HISTORY 10 START/STOP/DIR EXIT   00:00   HIDE </pre>
3.	Select the parameter with keys  and  . The current visibility (Visible/Hidden) of the selected parameter group is shown below it. Hidden parameter groups are indicated with an asterisk (*).	<pre> NC GROUPS 11 REFERENCE SELECT 12 CONSTANT SPEEDS   visible 13 ANALOGUE INPUTS 14 RELAY OUTPUTS EXIT   00:00   HIDE </pre>
4.	<ul style="list-style-type: none"> <li>To hide a visible group, press . Hiding a group also makes all of its parameters hidden.</li> <li>To show a hidden group, press . Showing a group also makes all of its parameters visible.</li> </ul>	<pre> NC GROUPS 11 REFERENCE SELECT 12*CONSTANT SPEEDS   hidden 13 ANALOGUE INPUTS 14 RELAY OUTPUTS EXIT   00:00   SHOW </pre>
5.	<p>When you exit the Groups menu, you are requested to confirm your changes.</p> <ul style="list-style-type: none"> <li>To cancel the new values and keep the original, select No with keys  and , and press .</li> <li>To save the new values, select Yes with keys  and , and press . Message “Saving parameter set” is shown briefly. If the saving succeeds, the panel LED is green for a moment and message “Set save OK” is shown before returning to the main Edit menu.</li> <li>To return to the previous menu, press .</li> </ul>	<pre> NC Confirm changes? No Yes  CANCEL   00:00   ENTER </pre>













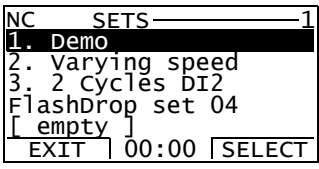
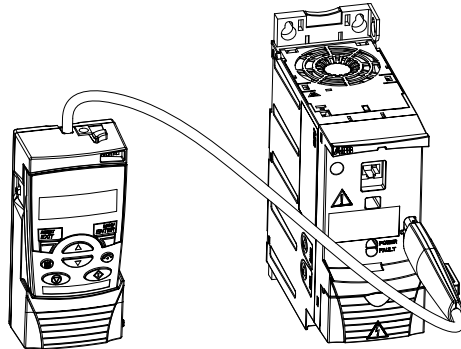
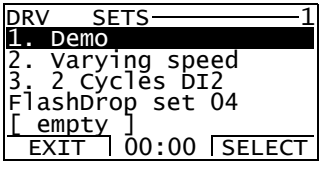

*How to delete a parameter set*

Step	Action	Display
1.	If you are not in the Main menu, press  repeatedly until you get there.	<pre> NC  MAIN MENU  —1 PARAMETERS TIME &amp; DATE DRIVE INFO   00:00   SELECT                     </pre>
2.	Go to the Parameters mode by selecting PARAMETERS on the menu with keys  and  , and pressing  .	<pre> NC  SET SELECT —1 1. Demo 2. Varying speed 3. 2 Cycles DI2 FlashDrop set 04 [ empty ] EXIT   00:00   SELECT                     </pre>
3.	Select the parameter set with keys  and  , and press  .	<pre> NC  SET ACTIONS —1 DOWNLOAD INFO EDIT DELETE EXIT   00:00   SELECT                     </pre>
4.	Select DELETE with keys  and  , and press  .	<pre> NC  Confirm delete? Cancel Delete CANCEL   00:00   ENTER                     </pre>
5.	<ul style="list-style-type: none"> <li>• To cancel the clearing of the set and return to the Set Actions menu, press  or select Cancel with keys  and , and press .</li> <li>• To clear the set, select Delete with keys  and , and press . Message “Deleting parameter set” is shown. If the clearing succeeds, the panel LED is green for a moment and message “Delete set OK” is shown briefly. The control panel returns to the set selection display. The cleared set is now shown as “[ empty ]”.</li> </ul>	<pre> NC  SET SELECT —1 [ empty ] 2. Varying speed 3. 2 Cycles DI2 FlashDrop set 04 [ empty ] EXIT   00:00   SELECT                     </pre>

### How to download a parameter set to a drive



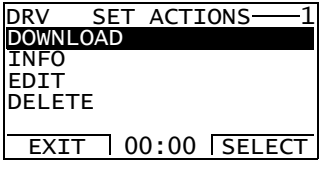

You must have a template compatible with the drive where you intend to download the set. For checking the drive information, see [How to view information about the drive connected to the FlashDrop](#) on page 27.

If there is no template with the properties you need, you have to download the correct template from the Internet according to the instructions in [How to download templates from the Internet](#) on page 28.



Step	Action	Display
1.	If you are not in the Main menu, press  repeatedly until you get there.	
2.	Go to the Parameters mode by selecting PARAMETERS on the menu with keys  and  , and pressing  .	
3.	<p>Ensure that the drive is disconnected from the mains (AC power source).</p> <p>Insert the programming tip in the FlashDrop connection of the drive. Depending on the drive type, the connection is located on the front of the drive or in the control panel recess.</p> <p>The top left corner of the FlashDrop display shows now DRV indicating that the FlashDrop is connected to a drive.</p> 	
4.	<ul style="list-style-type: none"> <li>Select the parameter set with keys  and , and press  to start the download. Message “Downloading parameter set” is shown briefly.</li> </ul> <p>or</p> <ul style="list-style-type: none"> <li>Select the parameter set with keys  and , and press .</li> </ul> <p>Then press  to start the download, or select DOWNLOAD with keys  and  and press . Message “Downloading parameter set” is shown briefly.</p> <p>The amount of parameter changes compared to default settings affects the download time.</p>	

Step	Action	Display
5.	If the download succeeds, the panel LED is green for a moment and message "Download successfully completed" is shown briefly before returning to the previous display.	<pre> DRV MESSAGE Download successfully completed  OK 00:00                     </pre>

*How to view information about the FlashDrop*

Step	Action	Display
1.	If you are not in the Main menu, press  repeatedly until you get there.	<pre> NC MAIN MENU 1 PARAMETERS TIME &amp; DATE DRIVE INFO 00:00 SELECT                     </pre>
2.	Go to the FlashD Info mode by selecting FLASHD INFO on the menu with keys  and  , and pressing  . The display shows the following information about the FlashDrop:  FIRMWARE:           firmware version of the base unit	<pre> NC FLASHD INFO FIRMWARE 101A  EXIT 00:00                     </pre>
3.	Return to the Main menu by pressing  .	<pre> NC MAIN MENU 1 TIME &amp; DATE DRIVE INFO FLASHD INFO 00:00 SELECT                     </pre>

*How to find out the control panel version*

Step	Action	Display
1.	If the power is switched on, switch it off.	
2.	Keep key  pressed down while you switch on the power and read the information. The display shows the following control panel information:  Panel SW: panel firmware version Rom CRC: panel ROM check sum Flash Rev: flash content version Flash content comment.  When you release the  key, the control panel goes to the Main menu.	<pre> PANEL VERSION INFO Panel SW:      X.XXX Rom CRC:      xxxxxxxxxx Flash Rev:     X.XX xxxxxxxxxxxxxxxxxxxxxxxx                     </pre>

# Fault tracing

## What this chapter contains

The chapter lists error messages and corrective actions.

## Error messages

An error message shown on the panel display indicates abnormal FlashDrop status. Reset the FlashDrop by pressing .

Using the information given in the table below, most error causes can be identified and corrected. If not, contact an ABB representative.

ERROR	CAUSE	WHAT TO DO
Download/Upload error 16 No drive connected	1) The programming tip is not inserted in the FlashDrop connection of the drive or the connection is loose. 2) The drive is not compatible with the FlashDrop.	1) Check that the programming tip is firmly inserted in the FlashDrop connection of the drive, see page 43. 2) Check that the drive is compatible with the FlashDrop, see page 13.
Upload error 51 Drive not connected or the drive is not compatible with the FlashDrop.	1) The programming tip is not inserted in the FlashDrop connection of the drive or the connection is loose. 2) The drive is not compatible with the FlashDrop.	1) Check that the programming tip is firmly inserted in the FlashDrop connection of the drive, see page 32. 2) Check that the drive is compatible with the FlashDrop, see page 13.
Download error 64 Incompatible drive type	The drive type of the set is not the same as the type of the drive where you are downloading the set.	Download a compatible set. If it does not exist, create a new set using the correct template, see page 30. If the FlashDrop or DrivePM does not have the appropriate template, download it from the Internet, see page 28.  For checking the set and drive information, see pages 34 and 27, respectively.
Download error 65 Incompatible drive rating	The drive rating of the set is not the same as the rating of the drive where you are downloading the set.	
Download error 68 Incompatible drive parameter table version	The parameter table version of the set is not the same as that of the drive where you are downloading the set.	
Download error 99 Incompatible drive localization	The localisation of the set is not the same as that of the drive where you are downloading the set.	
Set Open/Edit/Download/Upload error 35 No compatible template found	The set has been created using a template that does not currently exist in the FlashDrop.	Download the missing template from the DrivePM. If the DrivePM does not have a suitable template, download it from the Internet, see page 28. For finding out the properties of the template used in the set, check the drive type, area, control mode, parameter table version and drive rating in the set information, see page 34.
File open failed	File system error	Try again. If the operation still fails, contact your local ABB representative.
File save failed		
File clear failed		
CRC error		



# Maintenance and hardware diagnostics

---

## What this chapter contains

The chapter contains preventive maintenance instructions and LED indicator descriptions.

## Safety



**WARNING!** Read the instructions in section [Safety instructions](#) on page [13](#) before performing any maintenance on the equipment. Ignoring the safety instructions can cause injury or death.

---

## Maintenance intervals

The FlashDrop requires very little maintenance. The table lists the routine maintenance intervals recommended by ABB.

Maintenance	Interval	Instruction
Base unit battery charging	Approximately every four hours	See <a href="#">Charging</a> on page <a href="#">15</a> .
Base unit battery replacement	As needed	See <a href="#">Battery replacement</a> on page <a href="#">48</a> .
Control panel battery replacement	Every ten years	See <a href="#">Battery</a> on page <a href="#">48</a> .

## Software

It is possible to update the FlashDrop software using the DrivePM program. See the DrivePM help for more information.

## Base unit

### Battery replacement

Replace the batteries when the FlashDrop needs frequent recharging.

1. Switch off the base unit and disconnect the charger if in use.
2. Unscrew the screws in the bottom plate of the base unit and remove the plate.
3. Tip the base unit slightly to get out the battery holder.
4. Replace all the four batteries with rechargeable 1.2 V AA NiMH batteries. Use only batteries standing 1.3 amperes charging current (specified in the charger).
5. Put the battery holder back in place and attach the bottom plate.
6. Switch on the base unit.

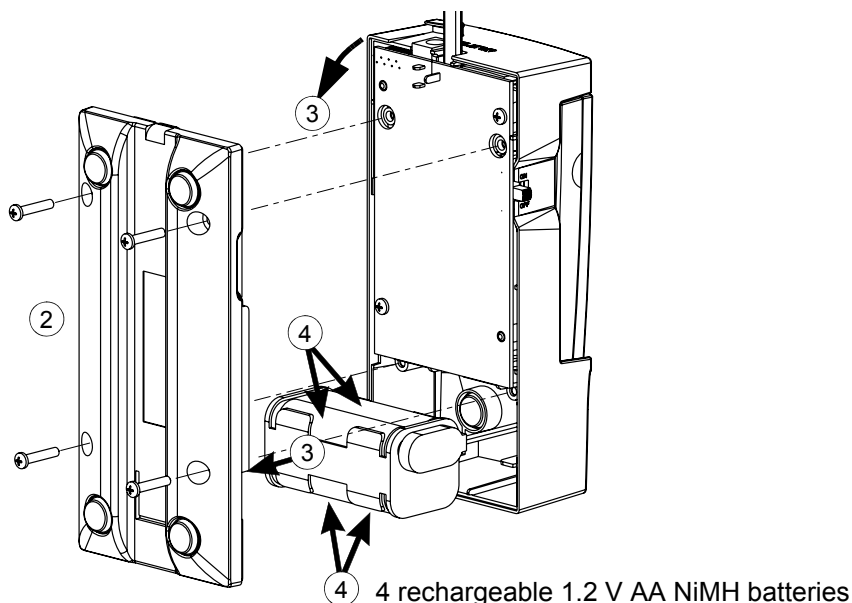

## Control panel

### Cleaning

Use a soft damp cloth to clean the control panel. Avoid harsh cleaners which could scratch the display window.

### Battery

The control panel uses a battery to keep the real time clock operating in memory during power interruptions.

The expected life for the battery is greater than ten years. To remove the battery, use a coin to rotate the battery holder on the back of the control panel. Replace the battery with type CR2032.

**Note:** The battery is NOT required for any control panel functions, except the clock.



## LEDs

The base unit indicates the battery charge level with four LEDs on the top right corner (1 in the figure). In addition, the base unit has a green and a red LED on the front (behind the control panel) to indicate the status of the FlashDrop (2). The control panel has one LED (3). The table below describes the LED indications.

Where	LED off	LED lit and steady		LED blinking	
On the top right corner of the base unit (1)	All LEDs off - no charge left	Green	Number of LEDs lit indicates the charge level, during charging all LEDs are lit.	-	
On the front of the base unit (2). If the control panel is attached to the base unit, remove it to be able to see the LEDs.	No power	Green	Ready	Green	-
		Red	Operation failed. Press OK to reset.	Red	-
At the top left corner of the control panel (3)	Ready	Green	Set download, saving or clearing has succeeded.	Green	-
		Red	-	Red	Operation failed. Press OK to reset.

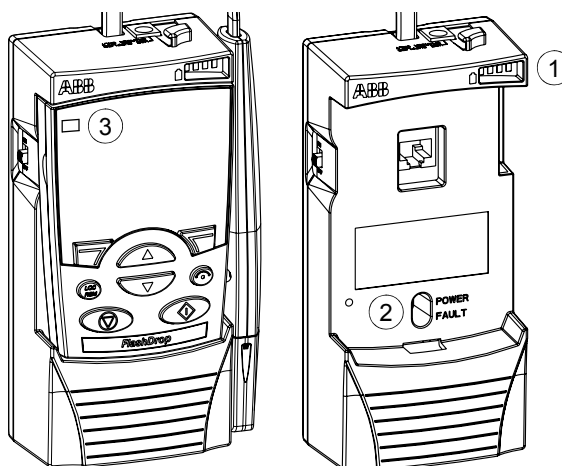



# Technical data

---

## What this chapter contains

The chapter contains the technical specifications of the FlashDrop: weight, time of use with one charge, charge time, ambient conditions, materials, applicable standards and markings.

### Weight

---

Approximately 0.4 kg (0.88 lb).

### Time of use with one charge

---

Approximately four hours with typical use.

### Charge time

---

Approximately 1.5 hours.

### Ambient conditions

---

Temperature -10 to +40°C (14 to 104°F). No frost allowed.

### Materials

---

<b>Base unit and programming tip enclosure</b>	PC/ABS 1.5...2.0 mm and PA66+25%GF 1.0 mm, all in colour NCS 1502-Y (RAL 9002 / PMS 420 C)
<b>Panel</b>	PC/ABS 1.5...2.0 mm, colour NCS 1502-Y (RAL 9002 / PMS 420 C) and PC 1.2 mm, clear
<b>Package</b>	Corrugated cardboard.
<b>Disposal</b>	<p>The FlashDrop contains raw materials that should be recycled to preserve energy and natural resources. The package materials are environmentally compatible and recyclable. All metal parts can be recycled. The plastic parts can either be recycled or burned under controlled circumstances, according to local regulations. Most recyclable parts are marked with recycling marks.</p> <p>If recycling is not feasible, all parts excluding electrolytic capacitors and printed circuit boards can be landfilled. The DC capacitors contain electrolyte and the printed circuit boards contain lead, both of which are classified as hazardous waste within the EU. They, as well as batteries, must be removed and handled according to local regulations.</p> <p>For further information on environmental aspects and more detailed recycling instructions, please contact your local ABB distributor.</p>

### Applicable standards

---

- IEC/EN 61800-3 (2004) The FlashDrop complies with the following standard:  
Adjustable speed electrical power drive systems. Part 3: EMC requirements and specific test methods

### CE marking

The FlashDrop carries the CE marking.

## Dimensions

The dimensional drawing of the FlashDrop is shown below. The dimensions are given in millimetres and [inches].

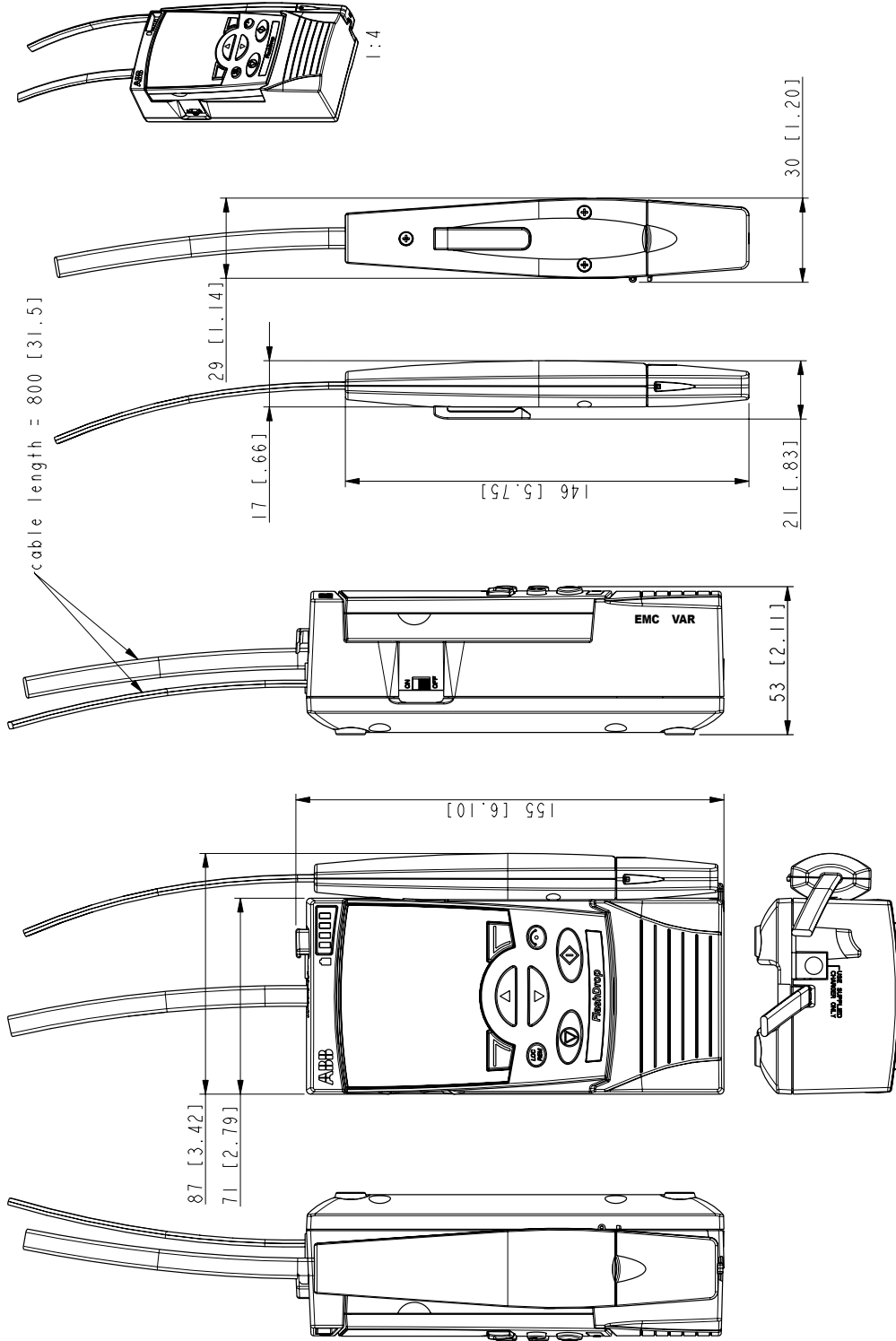

FlashDrop dimensions

# Glossary

---

## **Parameter table**

The parameter table is the feature of drive's firmware. The parameter table provides the parameters needed to define the user interface to a drive. The drive's parameters and their indexes, types, descriptive names, options, value ranges and selections, default values, dependencies on each other and action flags are defined in the drive firmware. All this data together is called as parameter table.

## **Parameter table version**

The parameter table has version number (P3305) which has the same format as the drive firmware version (P3301). Whenever there is added new parameter in the parameter table or there are made other changes in attributes of the parameter table, the parameter table version is changed. Typically the parameter table version is changed when new drive firmware version is released.

## **Parameter template**

The idea of parameter template is the same as with Power Point templates that are turned into presentations by adding more information to them. The template is the description of drive's parameter table for offline data processing purposes. For instance, the template makes it possible to edit the values of parameters in offline mode which is always the case when operating with FlashDrop base unit or DrivePM tool. The templates define all required parameter table attributes (e.g. descriptive names, value ranges and default values of parameters) in a form which is supported by both FlashDrop base unit and DrivePM tool.

The templates are parameter table version specific binary and ASCII files. When installing the DrivePM tool, the templates supplied by DrivePM CD-ROM are installed automatically in dedicated DrivePM subfolders. The template file name includes the parameter table version number. The templates supported by DrivePM tool have the file extension .par and the templates supported by FlashDrop base unit have the file extension .fdt. For example, the template file 251A\_EUR\_400V\_Scalar\_Industrial\_En.par describes the parameter table of European version of 400V ACS350 drive when used in scalar control mode in a form that is supported by DrivePM tool and the file ACS350\_251A\_Eur\_Scalar.fdt describes the same content in a form that is supported by FlashDrop base unit.

To ensure that FlashDrop parameter sets are always 100% compatible with the drive firmware, it is required that the target drive and the parameter set have exactly the same parameter table version. The parameter template is the base for the parameter set. Without template the creating and editing of a parameter set is not possible.

## **Parameter set**

The parameter set stores the parameter values and visibility information together with header and template related information (e.g. set's name, author, creation date and time, drive type and rating, localization and control mode). Based on the use of selected template the FlashDrop parameter set is created with FlashDrop base unit or with DrivePM PC tool (and then downloaded to the base unit). The parameter set

can be downloaded from the FlashDrop base unit to a drive. During the next power up of a drive, the downloaded parameter set comes over to active parameter set, customizes drive's control panel view and updates the content of user sets and override set.

**Size dependent / Size independent**

The drive size dependent parameter set is compatible only with drives which size (rating) complies with the size of the set in question. The drive size independent parameter set can be downloaded in a drive without rating limitation.

# Additional information

## State diagram of the panel user interface

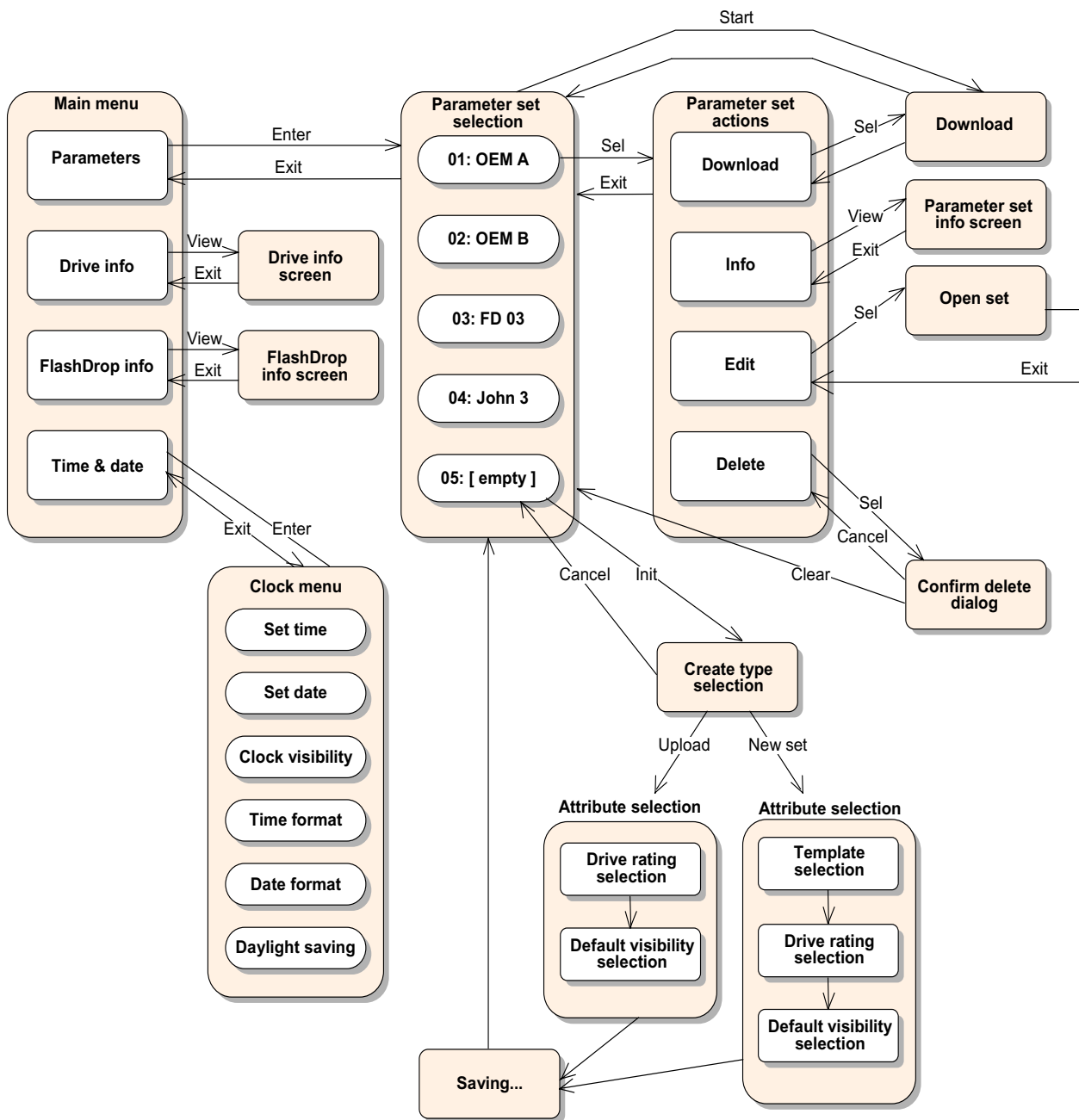

Continues to the next page.

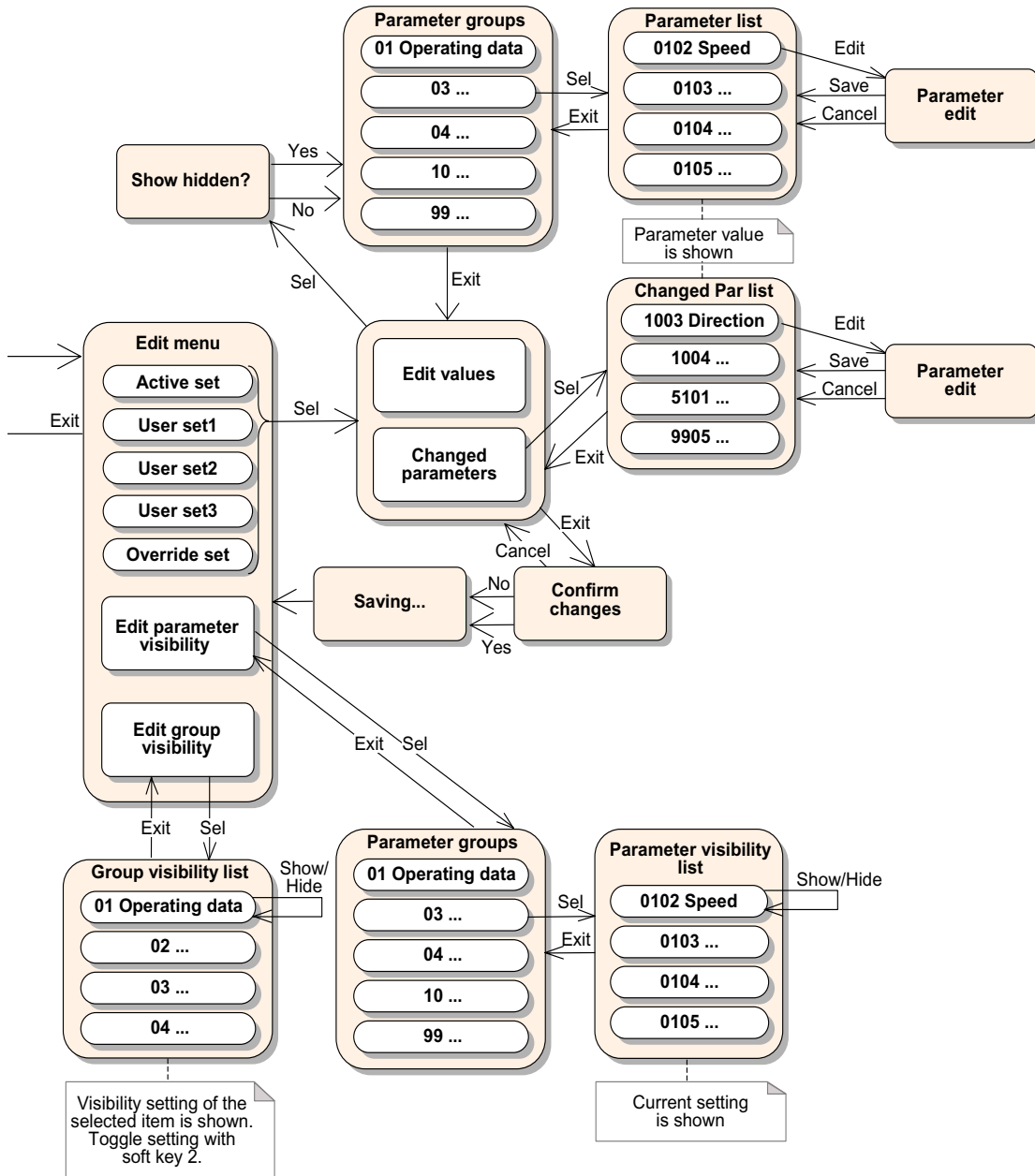

Continued from the previous page.



## Drive ratings table

	ACS150	ACS350	short size code
<b>200V, 1phase</b>	ACS150-01x-02A4-2	ACS350-01x-02A4-2	2A41
	ACS150-01x-04A7-2	ACS350-01x-04A7-2	4A71
	ACS150-01x-06A7-2	ACS350-01x-06A7-2	6A71
	ACS150-01x-07A5-2	ACS350-01x-07A5-2	7A51
	ACS150-01x-09A8-2	ACS350-01x-09A8-2	9A81
<b>200V, 3phase</b>	ACS150-03x-02A4-2	ACS350-03x-02A4-2	2A42
	ACS150-03x-03A5-2	ACS350-03x-03A5-2	3A52
	ACS150-03x-04A7-2	ACS350-03x-04A7-2	4A72
	ACS150-03x-06A7-2	ACS350-03x-06A7-2	6A72
	ACS150-03x-07A5-2	ACS350-03x-07A5-2	7A52
	ACS150-03x-09A8-2	ACS350-03x-09A8-2	9A82
		ACS350-03x-13A3-2	0132
	ACS350-03x-17A6-2	0172	
<b>400V, 3phase</b>	ACS150-03x-01A2-4	ACS350-03x-01A2-4	1A24
	ACS150-03x-01A9-4	ACS350-03x-01A9-4	1A94
	ACS150-03x-02A4-4	ACS350-03x-02A4-4	2A44
	ACS150-03x-03A3-4	ACS350-03x-03A3-4	3A34
	ACS150-03x-04A1-4	ACS350-03x-04A1-4	4A14
	ACS150-03x-05A6-4	ACS350-03x-05A6-4	5A64
	ACS150-03x-07A3-4	ACS350-03x-07A3-4	7A34
	ACS150-03x-08A8-4	ACS350-03x-08A8-4	8A84
		ACS350-03x-12A5-4	0124
		ACS350-03x-15A6-4	0154
		ACS350-03x-23A1-4	0234

	<b>ACS&amp;ACH550</b>	<b>short size code</b>
<b>200V, 3phase</b>	ACx550-xx-04A6-2	4A62
	ACx550-xx-06A6-2	6A62
	ACx550-xx-07A5-2	7A52
	ACx550-xx-012A-2	0122
	ACx550-xx-017A-2	0172
	ACx550-xx-024A-2	0242
	ACx550-xx-031A-2	0312
	ACx550-xx-046A-2	0462
	ACx550-xx-059A-2	0592
	ACx550-xx-075A-2	0752
	ACx550-xx-088A-2	0882
	ACx550-xx-114A-2	1142
	ACx550-xx-143A-2	1432
	ACx550-xx-178A-2	1782
	ACx550-xx-221A-2	2212
ACx550-xx-248A-2	2482	

	<b>ACS&amp;ACH550</b>	<b>short size code</b>
<b>400V, 3phase</b>	ACH550-01-02A4-4	2A44
	ACx550-xx-03A3-4	3A34
	ACx550-xx-04A1-4	4A14
	ACx550-xx-05A4-4	5A44
	ACx550-xx-06A9-4	6A94
	ACx550-xx-08A8-4	8A84
	ACx550-xx-012A-4	0124
	ACx550-xx-015A-4	0154
	ACx550-xx-023A-4	0234
	ACx550-xx-031A-4	0314
	ACx550-xx-038A-4	0384
	ACx550-xx-044A-4	0444
	ACx550-xx-045A-4	0454
	ACx550-xx-059A-4	0594
	ACx550-xx-072A-4	0724
	ACx550-xx-077A-4	0774
	ACx550-xx-078A-4	0784
	ACx550-xx-087A-4	0874
	ACx550-xx-096A-4	0964
	ACx550-xx-097A-4	0974
	ACx550-xx-124A-4	1244
	ACx550-xx-125A-4	1254
	ACx550-xx-157A-4	1574
	ACx550-xx-180A-4	1804
ACx550-xx-195A-4	1954	
ACx550-xx-246A-4	2464	
<b>400V, 3phase</b>	ACx550-xx-02A7-6	2A76
	ACx550-xx-03A9-6	3A96
	ACx550-xx-06A1-6	6A16
	ACx550-xx-09A0-6	9A06
	ACx550-xx-011A-6	0116
	ACx550-xx-017A-6	0176
	ACx550-xx-022A-6	0226
	ACx550-xx-027A-6	0276
	ACx550-xx-032A-6	0326
	ACx550-xx-041A-6	0416
	ACx550-xx-052A-6	0526
	ACx550-xx-062A-6	0626
	ACx550-xx-077A-6	0776
	ACx550-xx-099A-6	0996
	ACx550-xx-125A-6	1256
	ACx550-xx-144A-6	1446







---

**ABB Oy**

AC Drives  
P.O. Box 184  
FI-00381 HELSINKI  
FINLAND

Telephone +358 10 22 11  
Fax +358 10 22 22681  
Internet [www.abb.com](http://www.abb.com)

**ABB Inc.**

Automation Technologies  
Drives & Motors  
16250 West Glendale Drive  
New Berlin, WI 53151  
USA

Telephone 262 785-3200  
800-HELP-365  
Fax 262 780-5135

**ABB Limited**

Daresbury Park  
Daresbury  
Warrington  
Cheshire  
WA4 4BT  
UNITED KINGDOM

Telephone +44 1925 741111  
Fax +44 1925 741212

**ABB Beijing Drive Systems Co. Ltd.**

No. 1, Block D, A-10 Jiuxianqiao Beilu  
Chaoyang District  
Beijing, P.R. China, 100015

Telephone +86 10 5821 7788  
Fax +86 10 5821 7618  
Internet [www.abb.com](http://www.abb.com)

3AFE68591074 Rev B / EN  
EFFECTIVE: 5.3.2007