

# WedgeMaster FPD570

## Compact wedge flowmeter

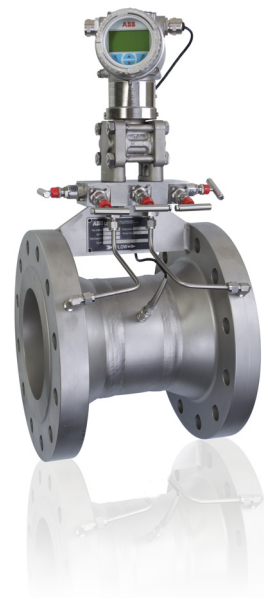

### Introduction

The WedgeMaster FPD570 flowmeter is a compact wedge flowmeter designed for the measurement of liquids, gases and steam in pipelines of DN25 to DN150 (1 in. to 6 in.). The meter combines a wedge sensor with an integral isolating/equalising manifold and transmitter in a single, leak tested and configured assembly. WedgeMaster has no critical metering surfaces to wear and requires fewer upstream and downstream straight pipe lengths than many DP devices.

This User Guide provides installation, connection, start-up and basic setup details for the system, with emphasis on the flow sensor. IOMaster is available with either a 364DS or 266DSH DP transmitter or a 267CS multivariable transmitter.

This User Guide should be used in conjunction with the following publications:

364DS DP transmitter:  
User Guide – IM/364

266DSH DP transmitter:  
User Guide HART– OI/266/HART-EN  
User Guide Foundation Fieldbus – OI/266/FF-EN  
Foundation Fieldbus Additional Instructions –  
OI/266/FF/ADD-EN  
User Guide Profibus PA – OI/266PA-EN

267CS Multivariable transmitter:  
User Guide – 267C/269C  
Communication Description-Profibus –  
PA/DP – 41/15-110-EN\_03  
Communication Description-Foundation Fieldbus –  
PA/DP – M/265/7/9/ADD/FF-EN\_01  
Communication Description-Modbus – 42/15-727-EN

# The Company

We are an established world force in the design and manufacture of measurement products for industrial process control, flow measurement, gas and liquid analysis and environmental applications.

As a part of ABB, a world leader in process automation technology, we offer customers application expertise, service and support worldwide.

We are committed to teamwork, high quality manufacturing, advanced technology and unrivalled service and support.

The quality, accuracy and performance of the Company's products result from over 100 years experience, combined with a continuous program of innovative design and development to incorporate the latest technology.

# Contents

<b>1</b>	<b>Safety</b>	<b>2</b>
1.1	Health & Safety	2
1.2	Electrical Safety – CEI / IEC 61010-1:2001-2	2
1.3	Symbols – CEI / IEC 61010-1:2001-2	2
1.4	Pressure Equipment Safety	3
1.5	User Guidelines	3
1.6	Permissible Process Media (Fluids)	3
1.7	Technical Limit Values	3
1.8	Safety Precautions	3
1.9	Potential Safety Hazards	3
<b>2</b>	<b>Installation</b>	<b>4</b>
2.1	General	4
2.1.1	Upstream Pipe Lengths	4
2.1.2	Weight	4
2.1.3	Dimensions	5
2.2	Meter Orientation	7
2.2.1	Horizontal Pipe Mounting – Gas Applications	7
2.2.2	Horizontal Pipe mounting – Liquid Applications	7
2.2.3	2.2.3 Horizontal Pipe Mounting – Liquid Steam Applications	7
2.3	Mechanical Installation	8
2.4	Remote RTD Installation	8
<b>3</b>	<b>Configuration</b>	<b>9</b>
<b>4</b>	<b>Commissioning</b>	<b>9</b>
4.1	Gas and Liquid Service	9
4.2	Steam Service	10
<b>5</b>	<b>Operation and Maintenance</b>	<b>11</b>
5.1	Troubleshooting	11
5.2	Dismantling / Removing the Meter from the Line	11
5.2.1	Flanged connection and Wafer Meter	11
5.3	Examination	11
5.4	Replacing of Removable Plate	12
5.5	Reassembly	12
5.6	Remotely Mounted RTD Replacement	12
<b>6</b>	<b>Specification</b>	<b>13</b>
	<b>Notes</b>	<b>16</b>

# 1 Safety

Information in this manual is intended only to assist our customers in the efficient operation of our equipment. Use of this manual for any other purpose is specifically prohibited and its contents are not to be reproduced in full or part without prior approval of the Technical Publications Department.

## 1.1 Health & Safety

### Health and Safety

To ensure that our products are safe and without risk to health, the following points must be noted:

- The relevant sections of these instructions must be read carefully before proceeding.
- Warning labels on containers and packages must be observed.
- Installation, operation, maintenance and servicing must only be carried out by suitably trained personnel and in accordance with the information given.
- Normal safety precautions must be taken to avoid the possibility of an accident occurring when operating in conditions of high pressure and / or temperature.
- Chemicals must be stored away from heat, protected from temperature extremes and powders kept dry. Normal safe handling procedures must be used.
- When disposing of chemicals ensure that no two chemicals are mixed.

Safety advice concerning the use of the equipment described in this manual or any relevant Material Safety Data Sheets (where applicable) may be obtained from the Company address on the back cover, together with servicing and spares information.



### 1.2 Electrical Safety – CEI / IEC 61010-1:2001-2













This equipment complies with the requirements of CEI / IEC 61010-1:2001-2 'Safety Requirements for Electrical Equipment for Measurement, Control and Laboratory Use' and complies with US NEC 500, NIST and OSHA.

If the equipment is used in a manner NOT specified by the Company, the protection provided by the equipment may be impaired.

### 1.3 Symbols – CEI / IEC 61010-1:2001-2

One or more of the following symbols may appear on the equipment labelling:

	Protective earth (ground) terminal.
	Functional earth (ground) terminal.

	Direct current supply only.
	Alternating current supply only.
	Both direct and alternating current supply.
	The equipment is protected through double insulation.
	This symbol, when noted on a product, indicates a potential hazard which could cause serious personal injury and / or death. The user should reference this instruction manual for operation and / or safety information.
	This symbol, when noted on a product enclosure or barrier, indicates that a risk of electrical shock and / or electrocution exists and indicates that only individuals qualified to work with hazardous voltages should open the enclosure or remove the barrier.
	This symbol indicates that the marked item can be hot and should not be touched without care.
	This symbol indicates the presence of devices sensitive to electrostatic discharge and indicates that care must be taken to prevent damage to them.
	This symbol identifies a risk of chemical harm and indicates that only individuals qualified and trained to work with chemicals should handle chemicals or perform maintenance on chemical delivery systems associated with the equipment.
	This symbol indicates the need for protective eye wear.
	This symbol indicates the need for protective hand wear.
	Electrical equipment marked with this symbol may not be disposed of in European public disposal systems. In conformity with European local and national regulations, European electrical equipment users must now return old or end-of-life equipment to the manufacturer for disposal at no charge to the user.
	Products marked with this symbol indicates that the product contains toxic or hazardous substances or elements. The number inside the symbol indicates the environmental protection use period in years.

## 1.4 Pressure Equipment Safety

### Warning.

- The Pressure Equipment described in this manual is supplied, where appropriate, in accordance with the European Directive 97/23/EC and is designed to work in pressurized systems. Take care when installing all equipment and follow the instructions given. Failure to do this could result in damage to equipment and create possible hazards to operators and other equipment. Only use the equipment on the process for which it is designed. Install the equipment into a system that has been designed to allow for venting or draining of the process. For the necessary safety requirements refer to the appropriate instructions in this manual.
- Do not exceed the pipe vibration levels stated in the Specification (see Section 6, page 13). Excessive vibration could result in damage to the equipment and create possible hazards to other equipment and operators.

## 1.5 User Guidelines

Correct use includes the following:

- Operation within the technical limit values.
- Observing and following the information provided on permissible media (fluids).
- Observing and following the instructions provided in the operating manuals.
- The following uses are not permitted:
  - Operation as a flexible adaptor in piping; for example, to compensate for pipe offsets, pipe vibrations and/or pipe expansions.
  - Use as a climbing aid; for example, for assembly purposes.
  - Use as a support for external loads; for example, as a support for piping.
  - Material gain; for example, by painting over the type plate or welding or soldering on parts.
  - Repairs, modifications, supplements or the installation of spare parts. These are permitted only if performed as described in the operating manual. More extensive work must be approved by ABB – the Company accepts no liability for unauthorized work.

The operating, maintenance and repair conditions that are stated in this manual must be observed. The Company accepts no liability for damage caused by usage that is incorrect or unprofessional.

## 1.6 Permissible Process Media (Fluids)

Process media may be used only if:

- It can be assured that the physical and chemical properties of the pressure-bearing materials that come into contact with the process medium are not reduced from that required for operational safety, during the expected lifetime of the equipment.
- Process media with unknown properties for erosion and/or corrosion may be used only if the operator can perform regular and suitable tests to assure the safe condition of the equipment.

## 1.7 Technical Limit Values

The equipment is intended for use only within the technical limit values specified on the data plate and in the Specification (see Section 6, page 13), including those for:

- The maximum working pressure.
- The maximum and minimum operating temperatures.
- The maximum vibration level stated in the Specification – see Section 6, page 13.

In addition, all connected pipework must be installed as it was designed, to ensure that there is no possibility of leakage or any undue stresses or strain acting upon it.

## 1.8 Safety Precautions

Instructions and procedures in this manual may require special precautions to ensure the safety of personnel performing the operations. Explosions could result in death or serious injury; therefore refer to the **Warnings** in the transmitter Operating Instructions (Transmitter operating manuals IM/364 Rev. 2 [V Design Level 1] SOI-266-XC-D-05-2011 [V Design Level 2] IM/267C/269C Rev. A [M Design Level 1]) before performing any operation in this manual.

## 1.9 Potential Safety Hazards

The following potential safety hazards are associated with operating the system:

- Electrical (line voltage)
- Product (FPD570) weight

## 2 Installation

### 2.1 General

#### 2.1.1 Upstream Pipe Lengths

The wedge element connections must have a length of straight unrestricted pipe on the upstream and downstream side of the wedge inside the element. The recommended minimum straight length on the upstream side of the wedge depends on the pipe diameter, and the fitting at the end of the straight run. Minimum upstream lengths are shown in Table 2.1. The recommended minimum length of downstream straight pipe run is 5 pipe diameters (5D) for all pipe fittings.

Item	Recommended	Minimum
Tee or Elbow	10D	5D
Concentric reducer or expander	10D	5D
Valve or Regulator	10D	5D
2 elbows in different planes	10D	5D

Table 2.1 Minimum Upstream Straight Pipe Length Required for Various Flow Obstructions

#### 2.1.2 Weight

Size mm (in.)	Flange Rating	Weight kg (lbs)
25 (1)	ASME CL150	18 (40)
	ASME CL300	20 (44)
	ASME CL600	20 (44)
	ASME CL900	24 (53)
	ASME CL1500	24 (53)
	ASME CL2500	26 (57)
	PN16	20 (44)
	PN25	20 (44)
	PN40	20 (44)
	PN63	22 (49)
PN100	22 (49)	
40 (1 1/2)	ASME CL150	20 (44)
	ASME CL300	22 (49)
	ASME CL600	24 (53)
	ASME CL900	28 (62)
	ASME CL1500	28 (62)
	ASME CL2500	38 (84)
	PN16	20 (44)
	PN25	20 (44)
	PN40	20 (44)
	PN63	24 (53)
PN100	24 (53)	

Size mm (in.)	Flange Rating	Weight kg (lbs)
50 (2)	ASME CL150	22 (49)
	ASME CL300	24 (53)
	ASME CL600	26 (57)
	ASME CL900	38 (84)
	ASME CL1500	38 (84)
	ASME CL2500	54 (119)
	PN16	22 (49)
	PN25	22 (49)
	PN40	22 (49)
	PN63	26 (57)
PN100	28 (62)	
80 (3)	ASME CL150	26 (57)
	ASME CL300	30 (66)
	ASME CL600	36 (79)
	ASME CL900	44 (97)
	ASME CL1500	60 (132)
	ASME CL2500	102 (225)
	PN16	24 (53)
	PN25	26 (57)
	PN40	26 (57)
	PN63	30 (66)
PN100	32 (71)	
100 (4)	ASME CL150	30 (66)
	ASME CL300	38 (84)
	ASME CL600	54 (119)
	ASME CL900	62 (137)
	ASME CL1500	82 (181)
	ASME CL2500	148 (326)
	PN16	26 (57)
	PN25	30 (66)
	PN40	30 (66)
	PN63	34 (75)
PN100	40 (88)	
150 (6)	ASME CL150	38 (84)
	ASME CL300	54 (119)
	ASME CL600	90 (198)
	ASME CL900	116 (256)
	ASME CL1500	166 (366)
	ASME CL2500	360 (794)
	PN16	32 (71)
	PN25	40 (88)
	PN40	40 (88)
	PN63	56 (123)
PN100	64 (141)	

2.1.3 Dimensions

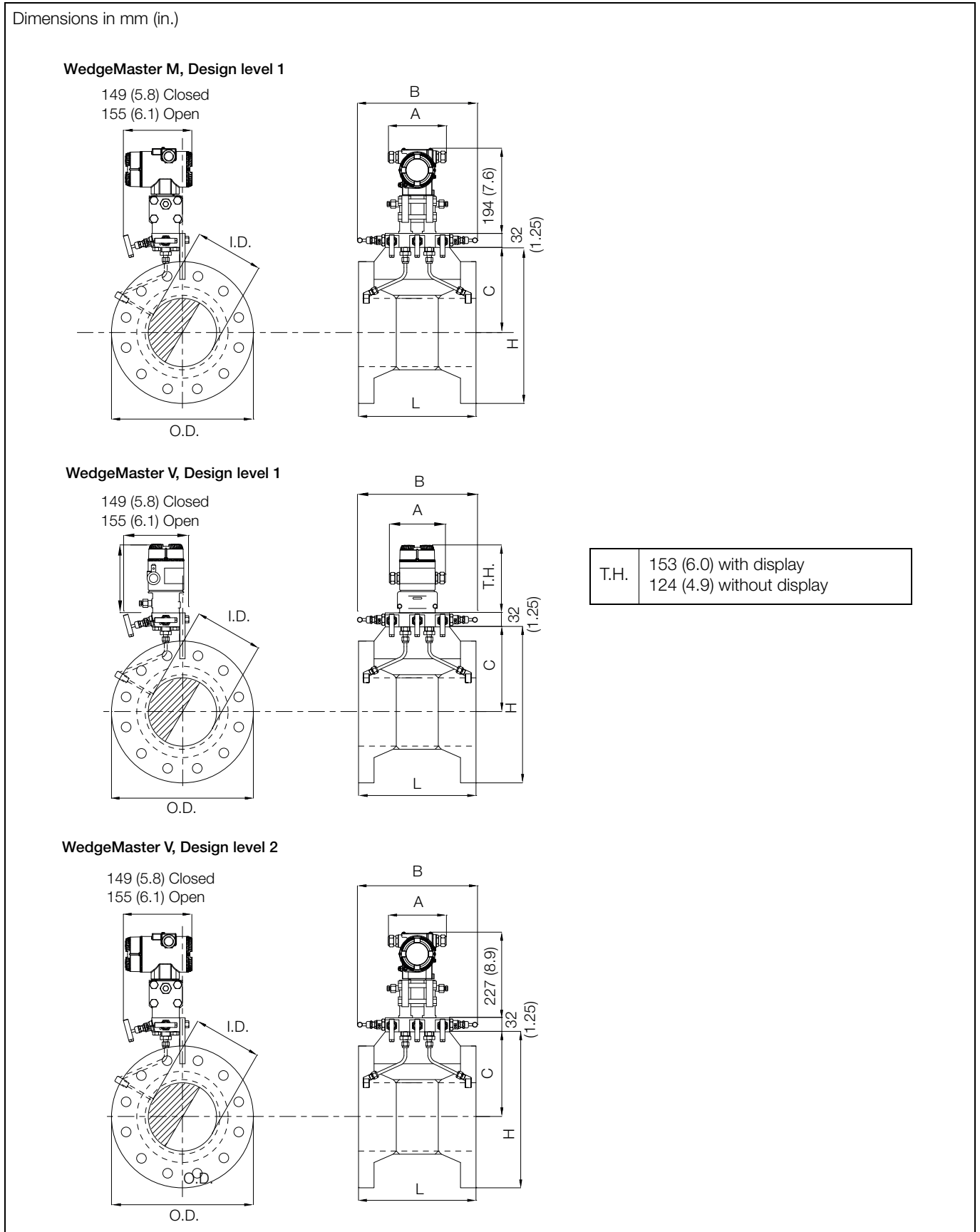

Fig. 2.1 WedgeMaster M, Design level 1

Dimensions in mm (in.)

		Size					
	Model	25 (1)	40 (1.5)	50 (2)	80 (3)	100 (4)	150 (6)
<b>C</b>	150LB	94 (3.70)	103.5 (4.07)	116 (4.57)	135.5 (5.33)	154.5 (6.08)	180 (7.09)
	300LB	102 (4.02)	118 (4.65)	123 (4.84)	145 (5.71)	167 (6.57)	199 (7.83)
	600LB	102(4.02)	118 (4.65)	123 (4.84)	145 (5.71)	177 (6.97)	218 (8.58)
	900LB	115 (4.53)	129 (5.08)	148 (5.83)	161 (6.34)	186.5 (7.34)	230.5 (9.07)
	1500LB	115 (4.53)	129 (5.08)	148 (5.83)	173.5 (6.83)	196 (7.72)	237 (9.33)
	2500LB	119.5 (4.70)	142 (5.59)	157.5 (6.20)	192.5 (7.58)	218 (8.58)	281.5 (11.08)
	PN16	97.5 (3.84)	115 (4.53)	122.5 (4.82)	140 (5.51)	150 (5.91)	182.5 (7.19)
	PN25	97.5 (3.84)	115 (4.53)	122.5 (4.82)	140 (5.51)	157.5 (6.20)	190 (7.48)
	PN40	97.5 (3.84)	115 (4.53)	122.5 (4.82)	140 (5.51)	157.5 (6.20)	190 (7.48)
	PN63	110 (4.33)	125 (4.92)	130 (5.12)	147.5 (5.81)	165 (6.50)	192.5 (7.58)
PN100	110 (4.33)	125 (4.92)	137.5 (5.41)	155 (6.10)	172.5 (6.79)	217.5 (8.56)	
<b>L</b>	150LB	108 (4.25)	121 (4.76)	149 (5.87)	187 (7.36)	225 (8.86)	300 (11.81)
	300LB	121 (4.76)	134 (5.28)	137 (5.39)	181 (7.13)	219 (8.62)	320 (12.60)
	600LB	124 (4.88)	140 (5.51)	147 (5.79)	191 (7.52)	254 (10.00)	335 (13.19)
	900LB	147 (5.79)	166 (6.54)	204 (8.03)	204 (8.03)	254 (10.00)	330 (12.99)
	1500LB	147 (5.79)	166 (6.54)	204 (8.03)	235 (9.25)	248 (9.76)	368 (14.49)
	2500LB	178 (7.01)	223 (8.78)	254 (10.00)	337 (13.27)	381 (15.00)	547 (21.54)
	PN16	81 (3.19)	114 (4.49)	118 (4.65)	168 (6.61)	205 (8.07)	288 (11.34)
	PN25	81 (3.19)	114 (4.49)	126 (4.96)	180 (7.09)	213 (8.39)	304 (11.97)
	PN40	81 (3.19)	114 (4.49)	118 (4.65)	180 (7.09)	213 (8.39)	304 (11.97)
	PN63	89 (3.50)	118 (4.65)	122 (4.80)	188 (7.40)	229 (9.02)	320 (12.60)
PN100	89 (3.50)	118 (4.65)	122 (4.80)	188 (7.40)	229 (9.02)	320 (12.60)	
<b>H</b>	150LB	148 (5.83)	167 (6.57)	192 (7.56)	231 (9.09)	269 (10.59)	320 (12.60)
	300LB	164 (6.46)	196 (7.72)	206 (8.11)	250 (9.84)	294 (11.57)	358 (14.09)
	600LB	164 (6.46)	196 (7.72)	206 (8.11)	250 (9.84)	314 (12.36)	396 (15.59)
	900LB	190 (7.48)	218 (8.58)	256 (10.08)	282 (11.10)	333 (13.11)	421 (16.57)
	1500LB	190 (7.48)	218 (8.58)	256 (10.08)	307 (12.09)	352 (13.86)	434 (17.09)
	2500LB	199 (7.83)	244 (9.61)	275 (10.83)	345 (13.58)	396 (15.59)	523 (20.59)
	PN16	155 (6.10)	190 (7.48)	205 (8.07)	240 (9.45)	260 (10.24)	325 (12.80)
	PN25	155 (6.10)	190 (7.48)	205 (8.07)	240 (9.45)	275 (10.83)	340 (13.39)
	PN40	155 (6.10)	190 (7.48)	205 (8.07)	240 (9.45)	275 (10.83)	340 (13.39)
	PN63	180 (7.09)	210 (8.27)	220 (8.66)	255 (10.04)	290 (11.42)	345 (13.58)
PN100	180 (7.09)	210 (8.27)	235 (9.25)	270 (10.63)	305 (12.01)	395 (15.55)	

Table 2.2 WedgeMaster FPD570 Dimensions



## 2.2 Meter Orientation

**Caution.** When installing WedgeMaster Ensure that the drains/vent valves are positioned to direct the process medium away from personnel and equipment when it is removed during drain and vent operations.

For all meter orientations ensure that the direction arrow on the meter body is aligned correctly with the direction of the flow in the pipeline.

### 2.2.1 Horizontal Pipe Mounting – Gas Applications

To ensure condensate drains back into the pipe mount the meter **above** the pipe, no more than 5 degrees from the vertical – see Fig. 2.2.

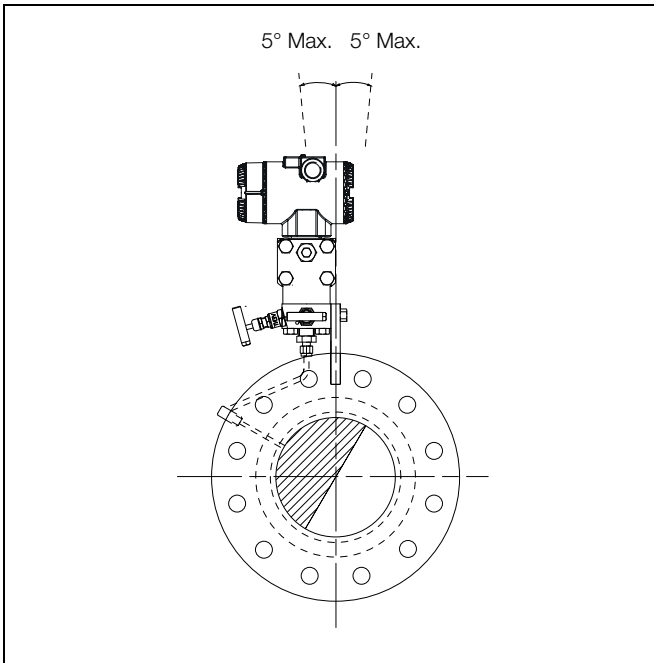

Fig. 2.2 Horizontal Pipe Mounting – Gas

### 2.2.2 Horizontal Pipe mounting – Liquid Applications

To ensure gases vent back into the pipe mount the meter **below** the pipe – see Fig. 2.3.

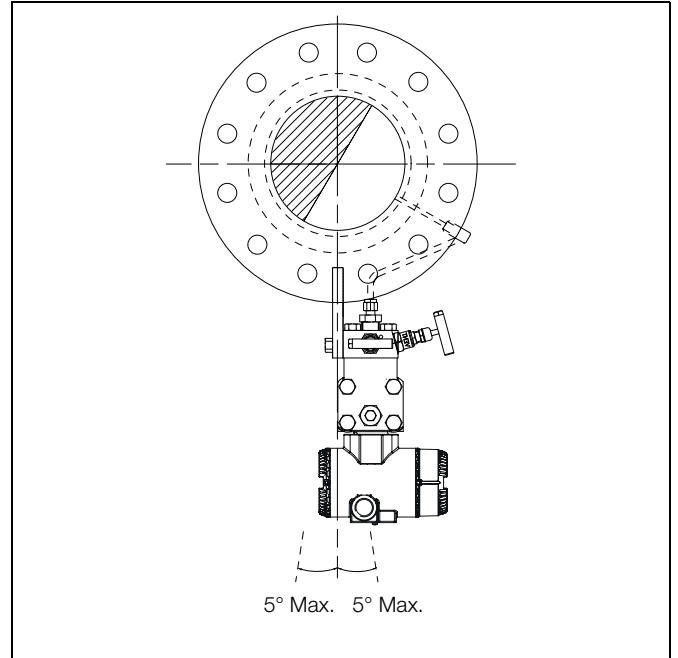

Fig. 2.3 Horizontal Pipe Mounting – Liquids

### 2.2.3 2.2.3 Horizontal Pipe Mounting – Liquid Steam Applications

Install the meter as shown In Fig. 2.4.

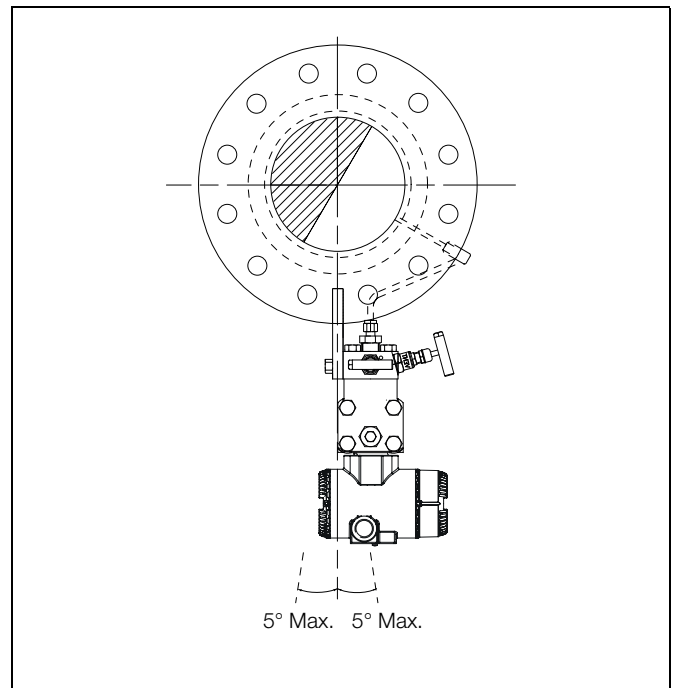

Fig. 2.4 Horizontal Pipe Mounting – Liquid Steam Applications

## 2.3 Mechanical Installation

**Note.** Before installation, read Section 1.4, General Safety Information.

**Caution.** Neither the transmitter or the valve handles is designed to withstand the weight of the meter. Do not lift the meter by either of the Valve handles or transmitter. Lift only by the main body of the meter.

1. Remove all packaging/ protection caps and check that the meter is clean and free of any damage or debris.
2. Check the Tag number of the meter to ensure it is the correct unit for the location and the flange rating is the same as the mating flanges.
3. When mounting the meter, be sure to position it so that the flow enters from the side as per the flow arrow on the label. Fig. 2.2 and it is orientated as per section 2.2.
4. Position the meter in-between the mating flanges and fit sufficient bolts into the lower part of the flanges to retain the meter in place.
5. Place the correct gaskets/ sealing rings in-between the flanges on both sides of the meter and align them to ensure they do not protrude into the pipe bore.
6. Fit the remainder of the bolts and evenly tighten all of the bolts hand tight.
7. Determine the maximum tightening torque according to the relevant flange specifications.
8. Tighten each bolt to the correct torque in a diagonally opposing pattern, firstly to 30% of the maximum torque, then 60% and finally to the maximum torque.

## 2.4 Remote RTD Installation

When the optional ABB remote RTD assembly (or any other RTD Assembly) is used, weld a mounting boss to the pipeline at a location 6 diameters downstream of the centreline of the orifice plate – see Fig. 2.5. Drill and tap the boss to accommodate the RTD assembly (Typically  $\frac{3}{4}$ " NPT for the ABB remote RTD assembly).

Alternative RTD assemblies may be used and the installation method modified to suit, but the 6 diameter downstream separation distance between the RTD and wedgemeter must be maintained.

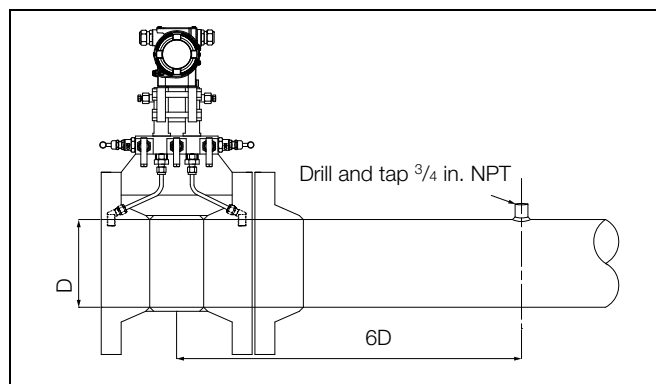

Fig. 2.5 Optional Remote RTD Assembly

## 3 Configuration

**Note.** If the meter has been supplied, pre configured by ABB, do not change parameter settings as this will cause erroneous meter readings.

To configure the meter, refer to the transmitter operation instructions (IM/267/C/269C).

## 4 Commissioning

### 4.1 Gas and Liquid Service

**Caution.** During the following procedure, wear Personal Protection Equipment appropriate for the process.

1. Install WedgeMaster as described in Section 2.3:
  - for horizontal pipe mounting – gas, refer to Fig. 2.2.
  - for horizontal pipe mounting – liquid, refer to Fig. 2.3.
  - for horizontal pipe mounting – steam, refer to Fig. 2.4.
2. Ensure the pipeline is full.
3. Gradually bring the pipeline up to normal operating pressure, checking for any leaks in the system. If leaks are detected, de-pressurize the pipeline and repair as necessary observing all local health and safety and environmental requirements.
4. When the system is at normal operating pressure and flow established, bleed the WedgeMaster impulse lines using the drain/vent valves. Collect and dispose of any bleed liquids in accordance with the local environmental regulations.

**Caution.** Ensure the drain/vent valves are positioned so that process fluid is directed down and away from personnel when it is removed during the drain/vent operation.

The differential pressure transmitter is normally supplied zeroed at atmospheric conditions (unless otherwise specified). To ensure correct operation, it must be zeroed at the normal operating pressure of the process.

To zero the transmitter:

1. Ensure the pipeline is at the normal operating pressure and that the transmitter power supply is on.
2. Close the high pressure (HP) and low pressure (LP) isolation valves.
3. Open the equalization valve/ The transmitter should now indicate a value close to zero.
4. Zero the differential pressure transmitter – refer to the transmitter's Operating Instructions (IM/267C/269C, IM/364 and SOI-266-XC-D).
5. Open the HP and LP isolation valves.
6. Close the equalization valve. The transmitter should now indicate flow. For information on fault diagnosis, refer to Section 5.1, page 11.

The differential pressure transmitter is normally supplied zeroed at atmospheric conditions (unless otherwise specified). To ensure correct operation, it must be zeroed at the normal operating pressure of the process.

To zero the transmitter:

1. Ensure the pipeline is at the normal operating pressure and that the transmitter power supply is on.
2. Close the HP and LP isolation valves.
3. Open the manifold equalization valve. The transmitter should now indicate a value close to zero.
4. Zero the differential pressure transmitter – refer to the transmitter's Operating Instructions (IM/267C/269C, IM/364 and SOI-266-XC-D).
5. Open the HP and LP isolation valves.
6. Close the equalization valve. The transmitter should now indicate flow. For information on fault diagnosis, refer to Section 5.1, page 11.

## 4.2 Steam Service

**Note.** Fill the impulse lines with water or condensate to ensure correct operation and to protect the transmitter from excessive temperatures.

1. Referring to Fig. 2.3, install WedgeMaster as described in Section 2.3.
2. Ensure the process pipeline is empty and de-pressurized.
3. Connect a suitable water supply to the pipeline.
4. Open the drain/vent valves.

**Caution.** Ensure the drain/vent valves are positioned to direct process fluid down and away from personnel when they are opened during the drain/vent operation.

5. Open the HP and LP isolation valves and allow water to flow **slowly** into the impulse lines until an air-free flow is obtained from the drain/vent valves, indicating that the impulse lines are full.
6. Close the HP and LP isolation valves.
7. Close the drain/vent valves and disconnect the water supply.
8. Gradually bring the pipeline up to normal operating pressure, checking for any leaks in the system. If leaks are detected, de-pressurize the pipeline and repair as necessary observing all local health and safety and environmental requirements.

## 5 Operation and Maintenance

### 5.1 Troubleshooting

Refer to the differential pressure transmitter's Operating Instructions (IM/267C/269C, IM/364 and SOI-266-XC-D) for procedures to be followed when error messages are shown on the transmitter display.

For other suspected problems, complete the following checks to ensure correct installation.

<b>Direction of flow</b>	Ensure the flow direction is in accordance with the arrow on the meter. If not, remove and reinstall the meter correctly.
<b>Mounting orientation</b>	Ensure the meter is correctly oriented to the pipework with regard to flow direction, pipeline and nature of the fluid. Incorrect orientation can lead to metering errors and in some cases may damage the meter.
<b>Zeroing of the transmitter</b>	Zero the differential pressure transmitter during installation and commissioning – see Section 4, page 9.
<b>Manifold valves</b>	The meter is either fitted with 3 or 5 valves. All valves are labelled with either Isolate, vent or equalise. During measurement, ensure all isolate valves are fully open and the Vent and Equalise valves are fully closed.
<b>Setup/configuration of the meter</b>	Ensure the 4 to 20 mA output of the meter is correctly set and that any receiving equipment is configured for the same flowrate range. Refer to the differential pressure transmitter's Operating Instructions (IM/267C/269C, IM/364 and SOI-266-XC-D) for information on how to check the loaded configuration.

Table 5.1 Troubleshooting Checks

### 5.2 Dismantling / Removing the Meter from the Line

**Caution.** Neither the transmitter nor the valve handles are designed to support the weight of the meter. Do not lift the meter by the valve handles or transmitter. Lift only by the main body of the meter.

Always observe the plant safety regulations. Before beginning work, ensure pipeline is depressurised and empty.

#### 5.2.1 Flanged connection and Wafer Meter

1. Loosen the flange securing bolts and/or nuts and partially separate the flanges.
2. Remove the bolts to enable the meter, together with the gaskets to be lifted clear, ensuring that no part of the meter is damaged.

### 5.3 Examination

**Note.**

- The frequency of examination depends upon the abrasive or corrosive nature of the process fluid, for example:
  - Steam – annually
  - Clean fluid – every 2 or 3 years.
- In the case of a new process or plant, examine the meter during each routine maintenance period until the wear of each installation, relative to others, can be assessed.

Examine the meter in accordance with the instructions in Section 2.3, step 4 on page 8.

#### 5.4 Replacing of Removable Plate

1. Remove the Orimaster from the pipeline as per instructions in Section 5.2.
2. Check the removable plate (including the fixings) for damage (as per the criteria of Section 2.3 point 4). If any damage or excess wear is found, it should be replaced.
3. Loosen all 6 fixing screws and remove.
4. Lift the plate out of its location slot.
5. Examine the fixing threads in the Orimaster body checking for damage. If damaged the whole unit should be replaced.
6. Take the new plate out of its protective wrapping and check for damage (again as per the criteria of Section 2.3 point 4).
7. Locate the new plate into the location slot and align the fixing holes with the fixing threads in the Orimaster body.
8. Insert each fixing screw in by hand and loosely tighten.
9. Using a suitably sized screwdriver tighten each fixing screw, working in a diagonally opposing pattern.
10. Check each screw again to ensure they are tight and secure.
11. Reinstall the Orimaster into the pipeline as per Section 5.5.

#### 5.5 Reassembly

Reassemble the meter in accordance with the instructions – see Section 2.3, page 8.

#### 5.6 Remotely Mounted RTD Replacement

To replace the RTD:

1. Ensure the transmitter is powered-down.
2. Remove the transmitter termination cover.
3. Disconnect the RTD wiring from the terminals and remove it from the cable entry.
4. Unscrew the RTD assembly from the thermowell. **DO NOT** remove the thermowell from the pipeline.

**Caution.** If there is **any** suspicion that process pressure has penetrated the thermowell, *completely depressurize the pipeline before removing the RTD assembly*. Additional precautions relating to the nature of the process fluid may also be required.

5. Screw the replacement RTD assembly into the thermowell.
6. Route the RTD wiring through the cable entry and reconnect to the appropriate terminals – refer to the transmitter Operating Instructions (IM/267C/269C, IM/364 and SOI-266-XC-D).
7. Power-up the transmitter.

## 6 Specification

### Standard H/D ratios

0.2, 0.3, 0.4, 0.5

(Restrictions apply depending on actual model code)

### Process connection

ANSI Class 150 , 300, 600, 900, 1500, 2500 RF and RTJ

ISO7005 NP10,16,25,40,63,100

or Wafer body (WMP only)

(Restrictions apply depending on actual model code)

### Construction materials

#### Process wetted parts

- Body: Carbon Steel, 316 St Steel
- Restriction: Carbon Steel, 316 St Steel

### Mounting hardware

- 3- or 5-valve manifold: 316 SST with Teflon™ packing
- Impulse lines/fittings: 316 SST

### Remote seal gasket

- Graphite for up to 645°F (340°C).

### Accuracy

#### Calibrated

±0.5% of actual flow when operated within the calibrated range

#### Bi-directional

As above when Kd2 designated as reverse flow coefficient

#### Repeatability

±0.2%

### Pressure Rating

100 bar (1440 lb/f/in<sup>2</sup>)

### Weights

Size mm (in.)	Flange Rating	Weight kg (lbs)
25 (1)	ASME CL150	18 (40)
	ASME CL300	20 (44)
	ASME CL600	20 (44)
	ASME CL900	24 (53)
	ASME CL1500	24 (53)
	ASME CL2500	26 (57)
	PN16	20 (44)
	PN25	20 (44)
	PN40	20 (44)
	PN63	22 (49)
40 (1 1/2)	ASME CL150	20 (44)
	ASME CL300	22 (49)
	ASME CL600	24 (53)
	ASME CL900	28 (62)
	ASME CL1500	28 (62)
	ASME CL2500	38 (84)
	PN16	20 (44)
	PN25	20 (44)
	PN40	20 (44)
	PN63	24 (53)
50 (2)	ASME CL150	22 (49)
	ASME CL300	24 (53)
	ASME CL600	26 (57)
	ASME CL900	38 (84)
	ASME CL1500	38 (84)
	ASME CL2500	54 (119)
	PN16	22 (49)
	PN25	22 (49)
	PN40	22 (49)
	PN63	26 (57)
80 (3)	ASME CL150	26 (57)
	ASME CL300	30 (66)
	ASME CL600	36 (79)
	ASME CL900	44 (97)
	ASME CL1500	60 (132)
	ASME CL2500	102 (225)
	PN16	24 (53)
	PN25	26 (57)
	PN40	26 (57)
	PN63	30 (66)
PN100	32 (71)	

Size mm (in.)	Flange Rating	Weight kg (lbs)
100 (4)	ASME CL150	30 (66)
	ASME CL300	38 (84)
	ASME CL600	54 (119)
	ASME CL900	62 (137)
	ASME CL1500	82 (181)
	ASME CL2500	148 (326)
	PN16	26 (57)
	PN25	30 (66)
	PN40	30 (66)
	PN63	34 (75)
PN100	40 (88)	
150 (6)	ASME CL150	38 (84)
	ASME CL300	54 (119)
	ASME CL600	90 (198)
	ASME CL900	116 (256)
	ASME CL1500	166 (366)
	ASME CL2500	360 (794)
	PN16	32 (71)
	PN25	40 (88)
	PN40	40 (88)
	PN63	56 (123)
PN100	64 (141)	

### Maximum process temperature

230 °C (446 °F)

### At the transmitter sensor

#### Silicone oil filled sensor F to H:

–40 and 121 °C (–40 and 250 °F)

#### Silicone oil filled sensor B, E:

–25 and 121 °C (–13 and 250 °F)

#### Inert (Galden) filled sensor F to H:

–20 and 100 °C (–4 and 212 °F)

#### Inert (Galden) filled sensor E:

–10 and 100 °C (14 and 212 °F)

#### Inert (Halocarbon) filled sensor F to H:

–20 and 100 °C (–4 and 212 °F)

#### Inert (Halocarbon) filled sensor E:

–10 and 100 °C (14 and 212 °F)

### IMPORTANT

For hazardous atmosphere applications see the temperature range specified on the certificate/approval relevant to the type of protection

### Ambient temperature limits

**Note.** LCD display may not be clearly readable below –20 °C (–4 °F) or above 70 °C (158 °F)

#### WedgeMaster V

Up to –40 and 85 °C (–40 and 185 °F)

LCD display limits:

- –40 and 85 °C (–40 and 185 °F)

#### WedgeMaster M

Transmitter:

- –40 to 85 °C (–40 to 185 °F)

LCD display limits:

- –20 to 70 °C (–4 to 158 °F)

All above may be further restricted depending on individual sensor capsule filling fluid

#### Storage limits

–50 to 85 °C (–58 to 185 °F)

LCD integral display:

- –40 to 85 °C (–40 to 185 °F)



## Integral display

### WedgeMaster V

- Wide screen LCD, 128 x 64 pixel, 52.5 x 27.2 mm (2.06 x 1.07 in.) dot matrix
- Multilanguage
- 4 keys for device configuration and management
- Totalized and instantaneous flow indication
- Display may also indicate diagnostic messages and provides configuration facilities

### WedgeMaster M

19-segment alphanumeric display (2-line, 6-character ) with additional bar chart display, optionally with back illumination.

---

## Environmental limits

### Electromagnetic compatibility (EMC)

Complies with EN 61326 and NAMUR NE-21

### Surge immunity level (with surge protector)

4 kV (according to IEC 1000-4-5 EN 61000-4-5)

### Pressure equipment directive (PED)

Complies with 97/23/EEC Category III Module H

### Humidity

Relative humidity:

- up to 100 %

Condensing, icing:

- admissible

### Vibration resistance

Accelerations up to 2 g at frequency up to 1000 Hz (according to IEC 60068-2-6)

### Shock resistance

Acceleration:

- 50 g

Duration:

- 11 ms (according to IEC 60068-2-27)

### Wet and dust-laden atmospheres

The meter is dust- and sand-tight and protected against immersion effects as defined by EN 60529 (1989) to IP 67 (IP 68 on request) or by NEMA to 4X

## Hazardous atmospheres

With or without integral display

### Combined ATEX code EW

(= E1 + E2 + E3 below)

### Combined ATEX and FM Approvals code EN

(= E1 + E2 + E3 + E4 + E6 below )

Intrinsic safety:

- ATEX Europe (code E1)
- II 1/2 G Ex ia IIC T6/T5/T4; IP67
- II 1 D Ex iaD 20 T85 °C
- II 1/2 D Ex iaD 21 T85 °C; IP67

Explosion proof:

- ATEX Europe (code E2)
- II 1/2 G Ex d IIC T6
- II 1/2 D Ex tD A21 T85 °C (-50 °C • Ta • +75 °C); IP67

Type 'N':

- ATEX Europe (code E3 ) type examination
- II 3 G Ex nL IIC T6/T5/T4
- II 3 D Ex tD A22 T85 °C; IP67

### FM Approvals US (code E6) and Canada (code E4)

Explosion proof (US):

- Class I, Div. 1, Groups A, B, C, D

Explosion proof (Canada):

- Class I, Div. 1, Groups B, C, D

Dust ignition proof:

- Class II, Div. 1, Groups E, F, G

Suitable for:

- Class II, Div. 2, Groups F, G; Class III, Div.1, 2

Non-incendive:

- Class I, Div. 2, Groups A, B, C, D

Intrinsically safe:

- Class I, II, III, Div. 1, Groups A, B, C, D, E, F, G
- Class I, Zone 0 AEx ia IIC T6/T4, Zone 0 (FM US)
- Class I, Zone 0 Ex ia IIC T6/T4, Zone 0 (FM Canada)

### FM Approvals US

Intrinsically safe (code EA):

- Class I; Division 1; Groups A, B, C, D;
- Class I; Zone 0; Group IIC; AEx ia IIC

Explosionproof (code EB):

- Class I, Division 1, Groups A, B, C, D;
- Class II/III, Division 1, Groups E, F, G

Refer to certificates for ambient temperature ranges (within the limits – 50 to 85°C) related to the different temperature classes

### CSA Approvals Canada (code EE):

Explosion Proof:

- Class I, Division 1, Groups B, C, D;
- Class II/III, Division 1, Groups E, F, G

## Notes

# Products and customer support

## Automation Systems

For the following industries:

- Chemical & Pharmaceutical
- Food & Beverage
- Manufacturing
- Metals and Minerals
- Oil, Gas & Petrochemical
- Pulp and Paper

## Drives and Motors

- AC and DC Drives, AC and DC Machines, AC Motors to 1kV
- Drive Systems
- Force Measurement
- Servo Drives

## Controllers & Recorders

- Single and Multi-loop Controllers
- Circular Chart and Strip Chart Recorders
- Paperless Recorders
- Process Indicators

## Flexible Automation

- Industrial Robots and Robot Systems

## Flow Measurement

- Electromagnetic Flowmeters
- Mass Flowmeters
- Turbine Flowmeters
- Wedge Flow Elements

## Marine Systems & Turbochargers

- Electrical Systems
- Marine Equipment
- Offshore Retrofit and Refurbishment

## Process Analytics

- Process Gas Analysis
- Systems Integration

## Transmitters

- Pressure
- Temperature
- Level
- Interface Modules

## Valves, Actuators and Positioners

- Control Valves
- Actuators
- Positioners

## Water, Gas & Industrial Analytics Instrumentation

- pH, Conductivity and Dissolved Oxygen Transmitters and Sensors
- Ammonia, Nitrate, Phosphate, Silica, Sodium, Chloride, Fluoride, Dissolved Oxygen and Hydrazine Analyzers
- Zirconia Oxygen Analyzers, Katharometers, Hydrogen Purity and Purge-gas Monitors, Thermal Conductivity

## Customer support

We provide a comprehensive after sales service via a Worldwide Service Organization. Contact one of the following offices for details on your nearest Service and Repair Centre.

### UK

ABB Limited

Tel: +44 (0)1946 830 611

Fax: +44 (0)1946 832 661

### USA

ABB Inc.

Tel: +1 215 674 6000

Fax: +1 215 674 7183

### Client Warranty

Prior to installation, the equipment referred to in this manual must be stored in a clean, dry environment, in accordance with the Company's published specification. Periodic checks must be made on the equipment's condition. In the event of a failure under warranty, the following documentation must be provided as substantiation:

- A listing evidencing process operation and alarm logs at time of failure.
- Copies of all storage, installation, operating and maintenance records relating to the alleged faulty unit.

# Contact us

## **ABB Limited**

### **Process Automation**

Salterbeck Trading Estate  
Workington, Cumbria  
CA14 5DS  
UK

Tel: +44 (0)1946 830 611

Fax: +44 (0)1946 832 661

## **ABB Inc.**

### **Process Automation**

125 E. County Line Road  
Warminster  
PA 18974  
USA

Tel: +1 215 674 6000

Fax: +1 215 674 7183

[www.abb.com](http://www.abb.com)

## Note

We reserve the right to make technical changes or modify the contents of this document without prior notice. With regard to purchase orders, the agreed particulars shall prevail. ABB does not accept any responsibility whatsoever for potential errors or possible lack of information in this document.

We reserve all rights in this document and in the subject matter and illustrations contained therein. Any reproduction, disclosure to third parties or utilization of its contents in whole or in parts – is forbidden without prior written consent of ABB.

Copyright© 2011 ABB

All rights reserved

3KXF511571R4201

OI/FPD670-EN 12.2011