

# CalMaster2 and CheckMaster Field and software tools



# The Company

We are an established world force in the design and manufacture of instrumentation for industrial process control, flow measurement, gas and liquid analysis and environmental applications.

As a part of ABB, a world leader in process automation technology, we offer customers application expertise, service and support worldwide.

We are committed to teamwork, high quality manufacturing, advanced technology and unrivalled service and support.

The quality, accuracy and performance of the Company's products result from over 100 years experience, combined with a continuous program of innovative design and development to incorporate the latest technology.

The UKAS Calibration Laboratory No. 0255 is just one of the ten flow calibration plants operated by the Company and is indicative of our dedication to quality and accuracy.

EN ISO 9001:2008



Cert. No. Q 05907

EN 29001 (ISO 9001)



Lenno, Italy –  
Cert. No. 9/90A

Stonehouse, U.K.



Information in this manual is intended only to assist our customers in the efficient operation of our equipment. Use of this manual for any other purpose is specifically prohibited and its contents are not to be reproduced in full or part without prior approval of the Technical Publications Department.

## Health and Safety

To ensure that our products are safe and without risk to health, the following points must be noted:

1. The relevant sections of these instructions must be read carefully before proceeding.
2. Warning labels on containers and packages must be observed.
3. Installation, operation, maintenance and servicing must only be carried out by suitably trained personnel and in accordance with the information given.
4. Normal safety precautions must be taken to avoid the possibility of an accident occurring when operating in conditions of high pressure and/or temperature.
5. Chemicals must be stored away from heat, protected from temperature extremes and powders kept dry. Normal safe handling procedures must be used.
6. When disposing of chemicals ensure that no two chemicals are mixed.

Safety advice concerning the use of the equipment described in this manual or any relevant hazard data sheets (where applicable) may be obtained from the Company address on the back cover, together with servicing and spares information.

<b>1</b>	<b>Safety</b>	<b>3</b>
1.1	Health & Safety	3
1.2	Electrical Safety – CEI/IEC 61010-1:2001-2	3
1.3	Symbols – CEI/IEC 61010-1:2001-2	3
1.4	Product Recycling Information	4
1.5	Product Disposal	5
1.6	Restriction of Hazardous Substances (RoHS)	5
1.7	Chemical Reagents	5
1.8	Safety Precautions	5
1.9	Safety Conventions	6
1.10	Safety Recommendations	6
1.11	Service and Repairs	6
1.12	Potential Safety Hazards	6
<b>2</b>	<b>Introduction</b>	<b>7</b>
2.1	CalMaster2 Options	8
<b>3</b>	<b>Preparation</b>	<b>9</b>
3.1	Unpacking	9
3.1.1	CheckMaster Leads:	10
<b>4</b>	<b>Installation</b>	<b>12</b>
4.1	Software Installation	12
4.1.1	Register CalMaster2 IRIS Software	12
4.1.2	Unlocking CalMaster2	13
4.2	MagMaster Connection	14
4.2.1	Fitting an Adaptor Board to a MagMaster	15
4.2.2	Connecting a MagMaster to a CalMaster2	16
4.3	AquaMaster Connection	17
4.3.1	AquaMaster with Hard-wired Sensor Leads	17
4.3.2	Removing the AquaMaster Cover	17
4.3.3	Fitting an AquaMaster Sensor Socket	18
4.3.4	Fitting an AquaMaster Pulsed Output Socket	19
4.3.5	Fitting an AquaMaster Pulsed Output Socket with Serial Communications	20
4.3.6	Fitting an Adaptor Box to the Sensor Cable – Bulgin Connectors	21
4.3.7	Fitting an Adaptor Box to the Sensor Cable – MIL Connectors	21
4.3.8	Adaptor Box Environmental Protection	22
4.3.9	Connecting an AquaMaster with MIL Connectors to a CalMaster2	22
4.3.10	Connecting an AquaMaster with a Sensor Adaptor Box to a CalMaster2	23
4.4	AquaMaster Explorer Connection	25
4.5	AquaMaster 3 Connections	26
4.5.1	Remote-Mounted Transmitter	26
4.5.2	Integral Transmitter	27

<b>5</b>	<b>Testing .....</b>	<b>28</b>
5.1	Testing a Flow Metering System .....	28
5.2	Connecting CalMaster2 to a Computer .....	30
5.3	Downloading Verifications .....	31
<b>6</b>	<b>CalMaster2 IRIS Software .....</b>	<b>32</b>
6.1	Introduction .....	32
6.2	CalMaster2 IRIS Interface .....	32
6.3	CalMaster2 IRIS Menus .....	34
6.4	CalMaster2 Wizard .....	35
6.4.1	Process Records .....	36
6.4.2	Review Records .....	37
6.5	Transmitter Wizard .....	40
6.5.1	New/Edit Configuration .....	41
6.6	Factory Fingerprint Files .....	42
6.7	Print a Conformance Report or Verification Certificate .....	43
6.8	Trend Analysis .....	44
6.8.1	Scale Tab .....	45
6.8.2	Names Tab .....	45
6.8.3	Statistics Tab .....	46
6.8.4	Data Filter Tab .....	46
6.9	CalMaster2 Database .....	47
<b>7</b>	<b>Recharging CalMaster2 .....</b>	<b>48</b>
<b>8</b>	<b>Registration .....</b>	<b>49</b>
8.1	Registering Flowmeters .....	51
8.2	Downloading Fingerprint Files .....	52
<b>Appendix A CalMaster2/CheckMaster Clock Utility .....</b>		<b>54</b>
<b>Notes .....</b>		<b>55</b>

# 1 Safety

Information in this manual is intended only to assist our customers in the efficient operation of our equipment. Use of this manual for any other purpose is specifically prohibited and its contents are not to be reproduced in full or part without prior approval of the Technical Publications Department.

## 1.1 Health & Safety

### Health and Safety

To ensure that our products are safe and without risk to health, the following points must be noted:

- The relevant sections of these instructions must be read carefully before proceeding.
- Warning labels on containers and packages must be observed.
- Installation, operation, maintenance and servicing must only be carried out by suitably trained personnel and in accordance with the information given.
- Normal safety precautions must be taken to avoid the possibility of an accident occurring when operating in conditions of high pressure and/or temperature.
- Chemicals must be stored away from heat, protected from temperature extremes and powders kept dry. Normal safe handling procedures must be used.
- When disposing of chemicals ensure that no two chemicals are mixed.

Safety advice concerning the use of the equipment described in this manual or any relevant Material Safety Data Sheets (where applicable) may be obtained from the Company, together with servicing and spares information.





## 1.2 Electrical Safety – CEI/IEC 61010-1:2001-2











This equipment complies with the requirements of CEI/IEC 61010-1:2001-2 'Safety Requirements for Electrical Equipment for Measurement, Control and Laboratory Use' and complies with US NEC 500, NIST and OSHA.

If the equipment is used in a manner NOT specified by the Company, the protection provided by the equipment may be impaired.

## 1.3 Symbols – CEI/IEC 61010-1:2001-2

One or more of the following symbols may appear on the equipment labelling:

	Protective earth (ground) terminal.
	Functional earth (ground) terminal.
	Direct current supply only.
	Alternating current supply only.
	Both direct and alternating current supply.

	The equipment is protected through double insulation.
	This symbol, when noted on a product, indicates a potential hazard which could cause serious personal injury and/or death. The user should reference this instruction manual for operation and/or safety information.
	This symbol, when noted on a product enclosure or barrier, indicates that a risk of electrical shock and/or electrocution exists and indicates that only individuals qualified to work with hazardous voltages should open the enclosure or remove the barrier.
	This symbol indicates that the marked item can be hot and should not be touched without care.
	This symbol indicates the presence of devices sensitive to electrostatic discharge and indicates that care must be taken to prevent damage to them.
	This symbol identifies a risk of chemical harm and indicates that only individuals qualified and trained to work with chemicals should handle chemicals or perform maintenance on chemical delivery systems associated with the equipment.
	This symbol indicates the need for protective eye wear.
	This symbol indicates the need for protective hand wear.
	Electrical equipment marked with this symbol may not be disposed of in European public disposal systems. In conformity with European local and national regulations, European electrical equipment users must now return old or end-of-life equipment to the manufacturer for disposal at no charge to the user.
	Products marked with this symbol indicates that the product contains toxic or hazardous substances or elements. The number inside the symbol indicates the environmental protection use period in years.

## 1.4 Product Recycling Information

	Electrical equipment marked with this symbol may not be disposed of in European public disposal systems after 12 August 2005. In conformity with European local and national regulations (EU Directive 2002/96/EC), European electrical equipment users must now return old or end-of-life equipment to the manufacturer for disposal at no charge to the user.
--	---

**Note.** For return for recycling, please contact the equipment manufacturer or supplier for instructions on how to return end-of-life equipment for proper disposal.

## 1.5 Product Disposal

**Note.** The following only applies to European customers.



ABB is committed to ensuring that the risk of any environmental damage or pollution caused by any of its products is minimized as far as possible. The European Waste Electrical and Electronic Equipment (WEEE) Directive (2002/96/EC) that came into force on August 13 2005 aims to reduce the waste arising from electrical and electronic equipment; and improve the environmental performance of all those involved in the life cycle of electrical and electronic equipment.

In conformity with European local and national regulations (EU Directive 2002/96/EC stated above), electrical equipment marked with the above symbol may not be disposed of in European public disposal systems after 12 August 2005.

## 1.6 Restriction of Hazardous Substances (RoHS)



The European Union RoHS Directive and subsequent regulations introduced in member states and other countries limits the use of six hazardous substances used in the manufacturing of electrical and electronic equipment. Currently, monitoring and control instruments do not fall within the scope of the RoHS Directive, however ABB has taken the decision to adopt the recommendations in the Directive as the target for all future product design and component purchasing.

## 1.7 Chemical Reagents

**Warning.** To familiarize yourself with handling precautions, dangers and emergency procedures, always review the Material Safety Data Sheets prior to handling containers, reservoirs, and delivery systems that contain chemical reagents and standards. Protective eye wear and protective hand wear. is always recommended when contact with chemicals is possible.

## 1.8 Safety Precautions

Please read the entire manual before unpacking, setting up, or operating this instrument.

Pay particular attention to all warning and caution statements. Failure to do so could result in serious injury to the operator or damage to the equipment.

To ensure the protection provided by this equipment is not impaired, do not use or install this equipment in any manner other than that which is specified in this manual.

## 1.9 Safety Conventions

**Warning.** In this manual, a warning is used to indicate a condition which, if not met, could cause serious personal injury and/or death. Do not move beyond a warning until all conditions have been met.

If a warning sign appears on the instrument itself, refer to Precautionary Labels – UL Certification and Electrical Safety – CEI/IEC 61010-1:2001-2 for an explanation.

**Caution.** A caution is used to indicate a condition which, if not met, could cause minor or moderate personal injury and/or damage to the equipment. Do not move beyond a caution until all conditions have been met.

**Note.** A note is used to indicate important information or instructions that should be considered before operating the equipment.

## 1.10 Safety Recommendations

For safe operation, it is imperative that these service instructions be read before use and that the safety recommendations mentioned herein be scrupulously respected. If danger warnings are not heeded to, serious material or bodily injury could occur.

**Warning.** The installation of the instrument should be performed exclusively by personnel specialized and authorized to work on electrical installations, in accordance with relevant local regulations.

## 1.11 Service and Repairs

None of the instrument's components can be serviced by the user. Only personnel from ABB or its approved representative(s) is (are) authorized to attempt repairs to the system and only components formally approved by the manufacturer should be used. Any attempt at repairing the instrument in contravention of these principles could cause damage to the instrument and corporal injury to the person carrying out the repair. It renders the warranty null and void and could compromise the correct working of the instrument and the electrical integrity or the CE compliance of the instrument.

If you have any problems with installation, starting, or using the instrument please contact the company that sold it to you. If this is not possible, or if the results of this approach are not satisfactory, please contact the manufacturer's Customer Service

## 1.12 Potential Safety Hazards

The following potential safety hazards are associated with operating the analyzer:

- Electrical (line voltage)
- Potentially hazardous chemicals



## 2 Introduction

CalMaster IRIS and CheckMaster are stand-alone verification and validation tools within the CalMaster2 Verification Suite.

CalMaster2 tests the integrity of a flow metering system by altering a number of flow measurement parameters and measuring the values returned from the flow measuring system. A report is displayed that verifies the performance of the system.

A CalMaster2 verification comprises a large number of separate test routines, including:

- Insulation and integrity tests of the entire flow meter system including the cables.
- Transmitter gain, linearity and zero point tests.
- Test of sensor magnetic properties.
- Digital output test.
- Analog output test.

The CalMaster IRIS/CheckMaster (see Section 2.1, page 8) test box displays the results of each test during the testing sequence. At the end of each test, a record is stored locally within the test box. Up to 100 test results can be stored.

Once the CheckMaster/CalMaster2 test box is connected to a PC that is running the CalMaster IRIS software, the stored test results can be uploaded and processed.

The Windows™-based CalMaster2 IRIS software that is provided as part of the CalMaster2 package enables electronic management and printing of the test results.

The CheckMaster/CalMaster2 test box can be used with:

### MagMaster

- HiFlo
- LoFlo
- Water/Waste Water
- Process hazardous Area

### AquaMaster and AquaMaster 3

- AquaMaster fitted with MIL SPEC connectors  
(hard-wired units can be upgraded – part no. WABC2024M)
- AquaMaster Explorer

## 2.1 CalMaster2 Options

There are two options of CalMaster2 available:

### ■ CalMaster IRIS

Enables the printing of service reports and certification to within 1% of factory calibration (fingerprinted flow meters) or 2% (non-fingerprinted flow meters). Predictive diagnostics are also provided to provide early warning of a possible system failure, enabling maintenance engineers to anticipate problems and take planned remedial action in advance.

CalMaster2 comprises:

- CalMaster IRIS Verification Tool
- Enhanced IRIS Software

### ■ CheckMaster

Enables the validation of flow meters and the printing of a service report.

CheckMaster comprises:

- CheckMaster Validation Tool
- IRIS Software

The functions available for each option are:

	CheckMaster	CalMaster IRIS	Page
Install Factory Files	x	✓	42
Transmitter Wizard	✓	✓	40
CalMaster2 Wizard	✓	✓	35
Flowmeter Calibration Verification Report	x	✓	43
Flowmeter Conformance Report	✓	✓	43
Trend Analysis	x	✓	44

Table 2.1 CalMaster2 Options

## 3 Preparation

### 3.1 Unpacking

Unpack and visually inspect the CalMaster2.

Also packed with the CalMaster2 are:

- CalMaster2 IRIS Software CD-ROM.
- This Instruction Manual.
- Universal mains adaptor and in-car adaptor.
- 5 MagMaster adaptor kits (Part no. WADX0089) — see Fig. 3.1.
- Connection Leads — see Section 3.1.1, page 10.

**Note.** Recharge the CalMaster2 before first use — see Section 7, page 48.

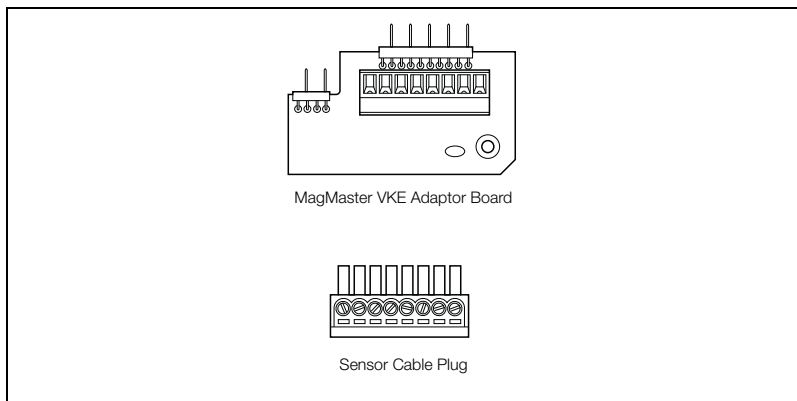
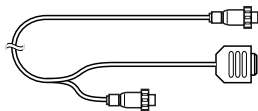
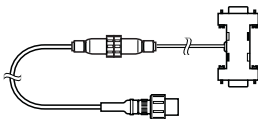

Fig. 3.1 MagMaster Adaptor Kit

**3.1.1 CheckMaster Leads:**  
**AquaMaster Communications Leads**  
(Red and Yellow numeric sleeves)



Communications Lead 1  
WEBC0221



RS232 Serial Communications Lead  
WEBC2000

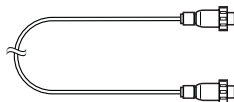

Communications Lead 3\*  
WEBC0221/T

\*for units with pulsed output socket with serial communications – not supplied with CalMaster 2 as standard.

**MagMaster Leads**  
(Yellow numeric sleeves)

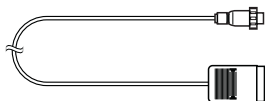

MagMaster Transmitter Lead 2  
WEBC0212

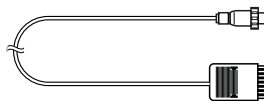

MagMaster Sensor Lead 3  
WEBC0213

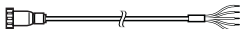

MagMaster Transmitter Lead 2  
WEBC0211

**AquaMaster MIL Connector Leads**  
(Green numeric sleeves)

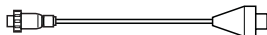

AquaMaster MIL Sensor Lead  
WEBC0233



AquaMaster 19-way Output Lead  
WEBC0235



CalMaster 2 VKG 7W MIL Output Lead  
WEBC0234



CalMaster 2 VKG 7W MIL Transmitter Lead  
WEBC0232

**AquaMaster Explorer Leads**  
(Red numeric sleeves)

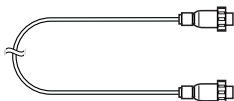

AquaMaster Transmitter Lead 2  
WEBC0222

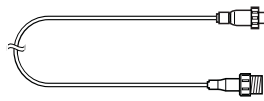

AquaMaster Transmitter Lead 3  
WEBC0223

**AquaMaster 3 Leads**

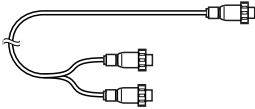

Communications Lead  
WEBC2038

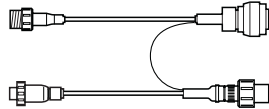

Sensor / Transmitter Leads  
WEBC0239

## 4 Installation

### 4.1 Software Installation

**Note.** To install CalMaster2 successfully, 'Administrator' rights for the computer are required.

Insert the CD into the computer, the install program should start automatically. If it does not, from the Windows 'Start' menu, select 'Run...' and type 'D:\Setup.exe' (where D is the drive letter of the CD ROM) and press 'Enter'.

Follow the on-screen instructions to install.

#### 4.1.1 Register CalMaster2 IRIS Software

The first time the CalMaster2 IRIS software is used, a registration screen appears:



To register the CalMaster2 IRIS software:

1. Type the 'User name', 'Company name' and 'Customer identification number'.

**Note.** The 'Customer identification number' is printed on the label of the CD.

2. Select to either create a PDF of the registration or send the details by email:
  - To create a PDF, select the 'Create a pdf file for printing or faxing' check box.
  - To send an email, leave the 'Create a pdf file for printing or faxing' check box unselected.

3. Click 'Next'. Either an e-mail is sent to [calmaster@gb.abb.com](mailto:calmaster@gb.abb.com) automatically or a PDF is created:
  - If an e-mail was sent, a response will be received within 24 hours. A confirmation message that the e-mail has been sent appears.
  - If a PDF was created, print the PDF and either send it to:

ABB Limited  
CalMaster Helpline  
Oldends Lane, Stonehouse  
Gloucestershire  
GL10 3TA  
UK  
or Fax it to: +44 (0)1453 829671

4. Click 'Close' to exit CalMaster2.

**Note.** At any time, CalMaster can be re-registered by clicking 'Re-Register'. A new e-mail to ABB will be created.

#### 4.1.2 Unlocking CalMaster2

When the registration e-mail or letter is received from ABB:

1. Copy the registration number provided and start the CalMaster2 IRIS software. The Registration dialog box appears:



2. Paste the registration number into the text box and click 'Next'. The CalMaster2 IRIS software is unlocked with an appropriate licence.

## 4.2 MagMaster Connection

To enable a MagMaster system to be tested by the CalMaster2 it may be necessary to fit a small adaptor board (see Section 4.2.1, page 15) to the MagMaster.

**Note.** The newer series VKH MagMaster does not require this adaptor board as one is already incorporated into its design.

Once the adaptor is fitted to the MagMaster transmitter, the CalMaster2 can be connected easily to the transmitter for testing at any time.

Extra adaptor kits are available (part no. WADX0089).

To enable a hard-wired MagMaster system to be tested by the CalMaster2 it may be necessary to fit a small adaptor board (see Section 4.2.1, page 15) to the MagMaster.

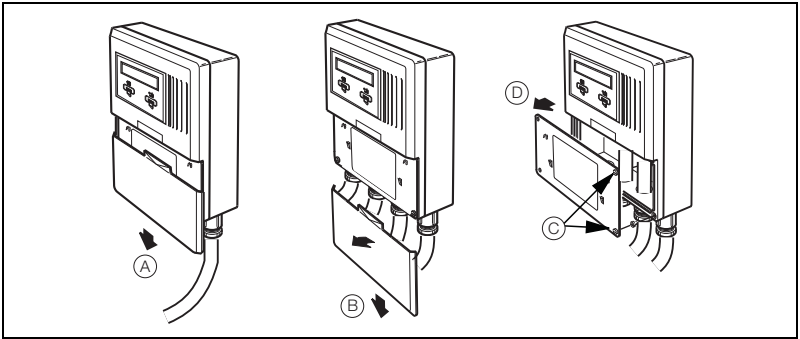

Fig. 4.1 Removing the MagMaster Covers

To remove the MagMaster covers:

1. Slide the cover (A) down.
2. Pull out slightly and slide off (B).
3. Slacken the captive screws (C).
4. Remove the protective cover (D).





### 4.2.2 Connecting a MagMaster to a CalMaster2

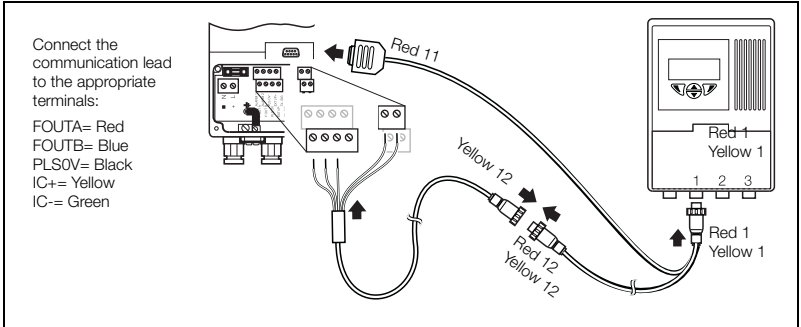

Fig. 4.4 Fitting Communications Leads

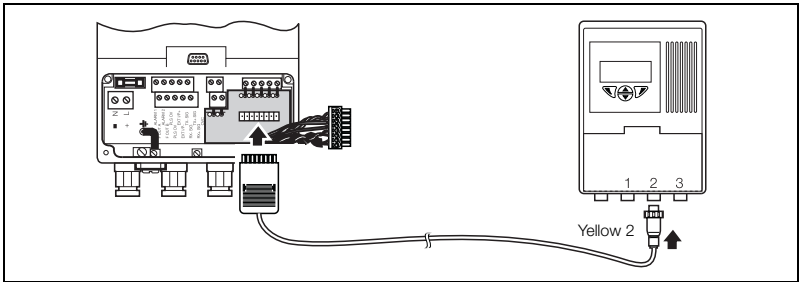

Fig. 4.5 Fitting Transmitter Leads

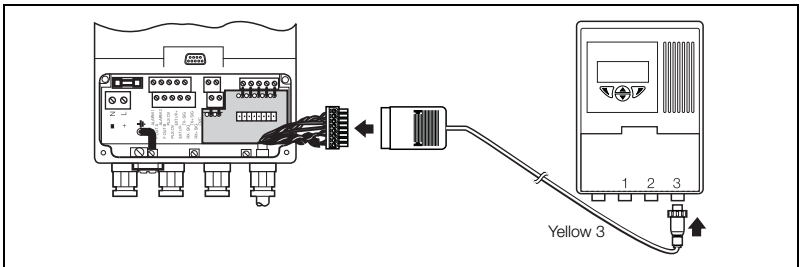

Fig. 4.6 Fitting Sensor Leads

To test a MagMaster refer to see Section 5, page 28.

### 4.3 AquaMaster Connection

#### 4.3.1 AquaMaster with Hard-wired Sensor Leads

To enable a hard-wired AquaMaster system to be tested by the CalMaster2 it may be necessary to fit a socket to the AquaMaster (see Section 4.3.3, page 18) and a small adaptor box to the end of the sensor cable (see Section 4.3.6, page 21).

**Note.** Carefully remove the potting from hard-wired AquaMasters that have been potted. Re-pot the Aquamaster after the new sockets have been fitted.

#### 4.3.2 Removing the AquaMaster Cover

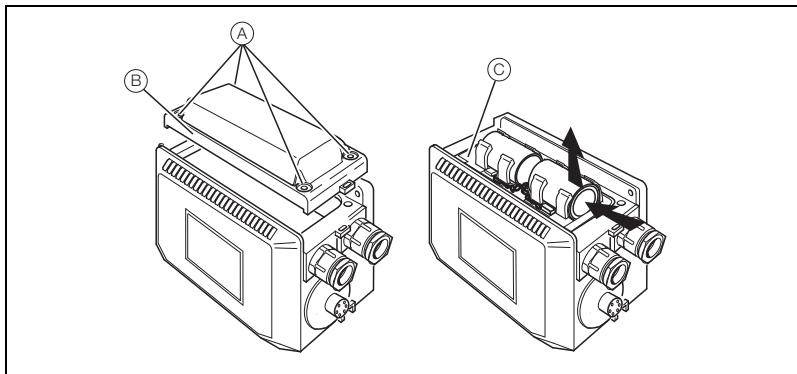

Fig. 4.7 Removing the AquaMaster Cover

To remove the AquaMaster cover:

1. Slacken the captive screws (A).
2. Remove the cover (B).
3. Press the battery tray retaining tabs and remove the battery tray (C).

### 4.3.3 Fitting an AquaMaster Sensor Socket

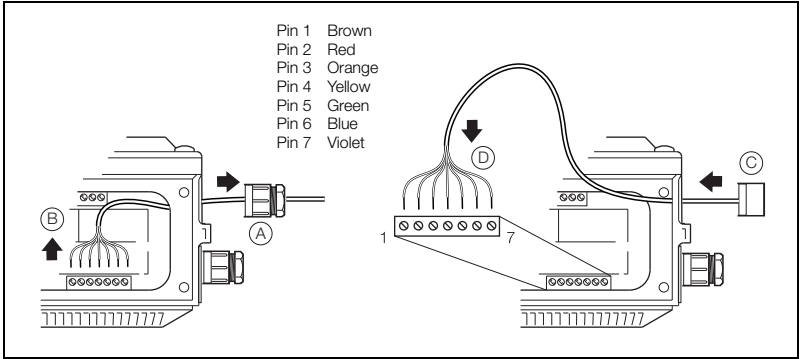

Fig. 4.8 Fitting an AquaMaster Sensor Socket

To fit an AquaMaster sensor socket:

1. Turn off the power to the AquaMaster and remove the covers – see Section 4.3.2, page 17.
2. Disconnect and withdraw the sensor cable (A).
3. Remove and discard the gland (B).
4. Feed the socket lead into the AquaMaster and fit the socket (MGFA0609-S) (C).
5. Connect the sensor cable (D).
6. Replace the covers – see Fig. 4.7, page 17.

### 4.3.4 Fitting an AquaMaster Pulsed Output Socket

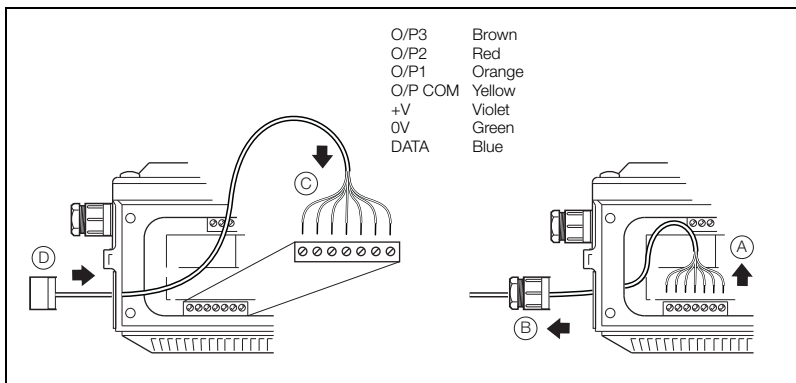

Fig. 4.9 Fitting an AquaMaster Pulsed Output Socket

To fit an AquaMaster pulsed output socket:

1. Turn off the power to the AquaMaster and remove the covers – see Section 4.3.2, page 17.
2. Disconnect and withdraw the pulsed output cable (A).
3. Remove and discard the gland (B).
4. Feed the socket lead into the AquaMaster and fit the socket (MGFA0609-S) (C).
5. Connect the sensor cable (D).
6. Replace the covers – see Fig. 4.7, page 17.

### 4.3.5 Fitting an AquaMaster Pulsed Output Socket with Serial Communications

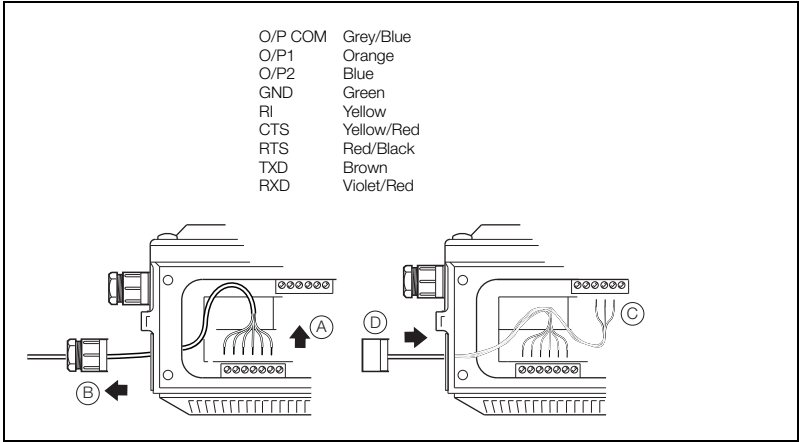

Fig. 4.10 Fitting an AquaMaster Pulsed Output Socket with Serial Communications

To fit an AquaMaster pulsed output socket with serial communications:

1. Turn off the power to the AquaMaster and remove the covers – see Section 4.3.2, page 17.
2. Disconnect and withdraw the pulsed output cable (A).
3. Remove and discard the gland (B).
4. Feed the socket lead into the AquaMaster and fit the socket (MGFA0609-O) (C).
5. Connect the sensor cable (D).
6. Replace the covers – see Fig. 4.7, page 17.

### 4.3.6 Fitting an Adaptor Box to the Sensor Cable – Bulgin Connectors

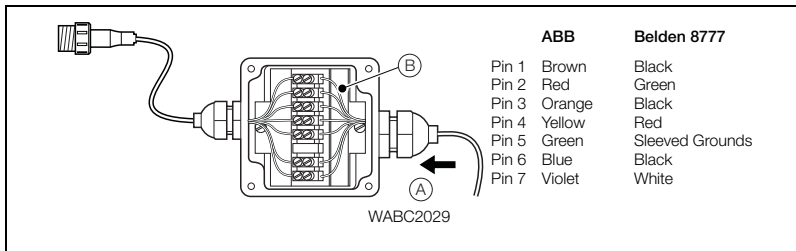

Fig. 4.11 Fitting an Adaptor Box to the Sensor Cable – Bulgin Connectors

To fit an adaptor box to the sensor cable:

1. Remove the cover of the adaptor box.
2. Feed the sensor lead (A) into the adaptor box.
3. Connect the sensor cable (B).
4. If required, provide environmental protection – see Section 4.3.8, page 22.
5. Tighten the gland and replace the covers.

### 4.3.7 Fitting an Adaptor Box to the Sensor Cable – MIL Connectors

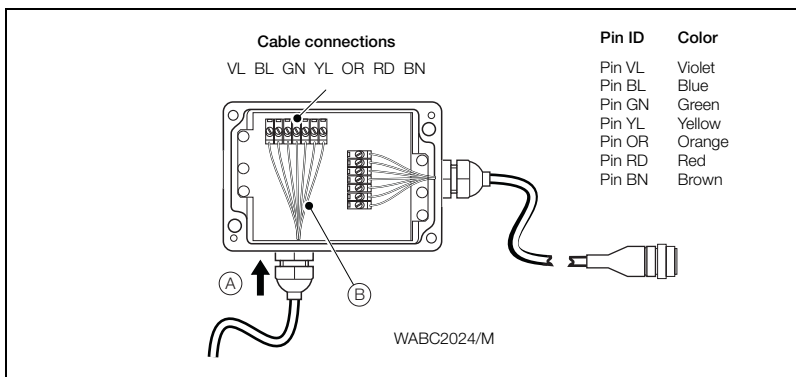

Fig. 4.12 Fitting an Adaptor Box to the Sensor Cable – MIL Connectors

To fit an adaptor box to the sensor cable:

1. Remove the cover of the adaptor box.
2. Feed the sensor lead (A) into the adaptor box.
3. Connect the sensor cable (B).
4. If required, provide environmental protection – see Section 4.3.8, page 22.

5. Tighten the glands and replace the cover.

#### 4.3.8 Adaptor Box Environmental Protection

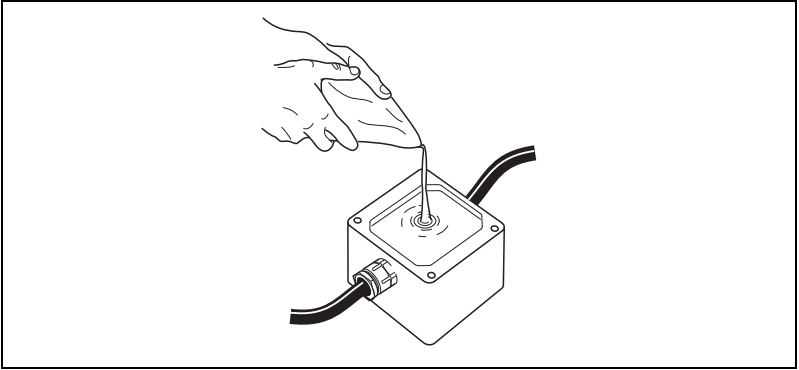

Fig. 4.13 Potting the Adaptor Box

#### Warning.

- Potting materials are toxic – use suitable safety precautions.
- Read the manufacturers' instructions carefully before preparing the potting material.
- Check all connections before potting – see Section 4.3.6, page 21.
- Do not overfill or allow the potting material to come into contact with 'O' rings or grooves.

#### 4.3.9 Connecting an AquaMaster with MIL Connectors to a CalMaster2

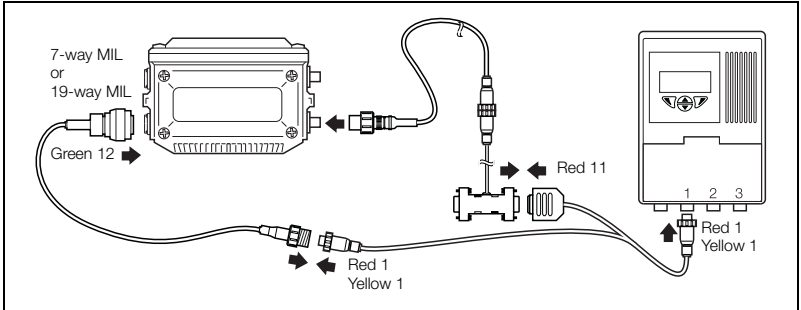

Fig. 4.14 Fitting Communications Leads



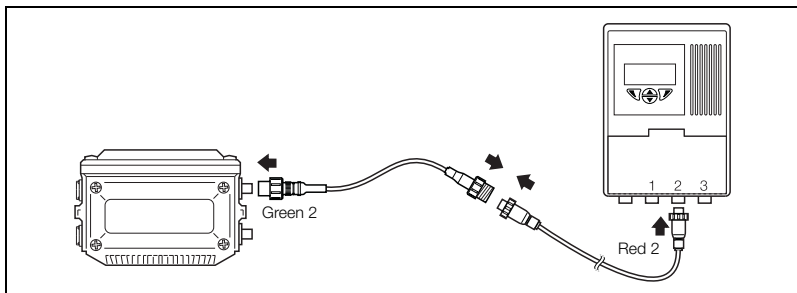

Fig. 4.15 Fitting Transmitter Leads

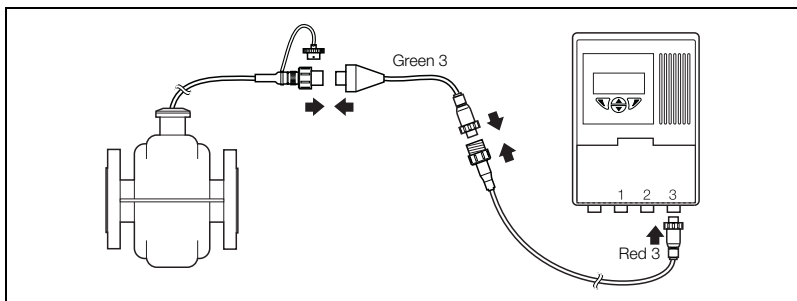

Fig. 4.16 Fitting Sensor Leads

To test an AquaMaster, see Section 5, page 28.

#### 4.3.10 Connecting an AquaMaster with a Sensor Adaptor Box to a CalMaster2

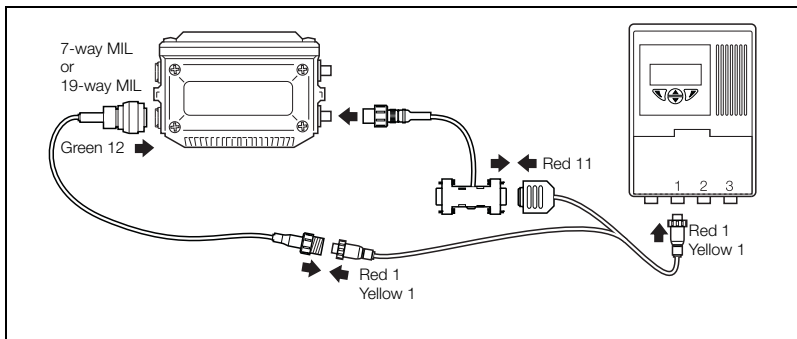

Fig. 4.17 Fitting Communications Leads

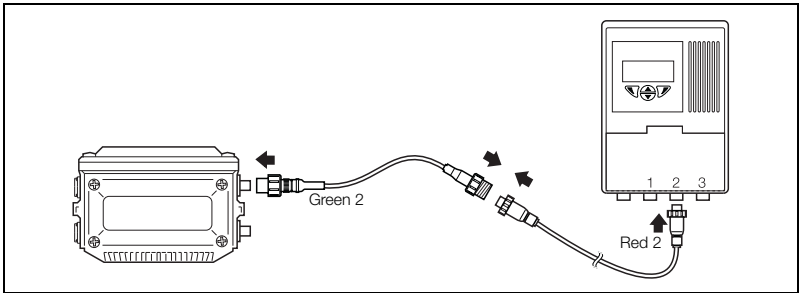

Fig. 4.18 Fitting Transmitter Leads

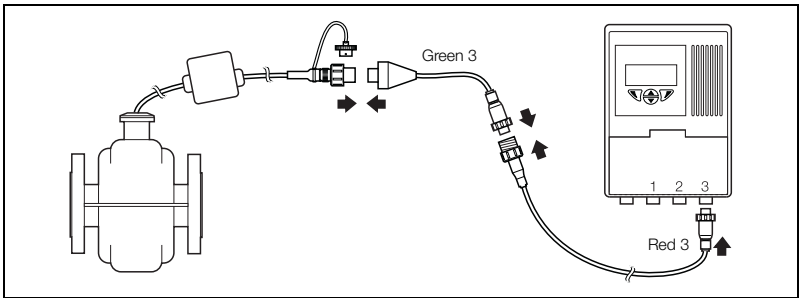

Fig. 4.19 Fitting Sensor Leads

To test an AquaMaster, see Section 5, page 28.

### 4.4 AquaMaster Explorer Connection

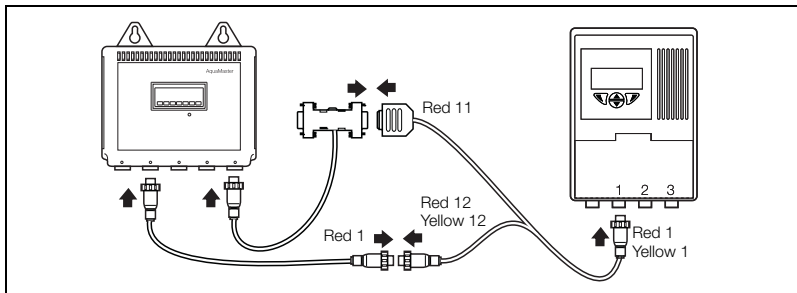

Fig. 4.20 Fitting Communications Leads

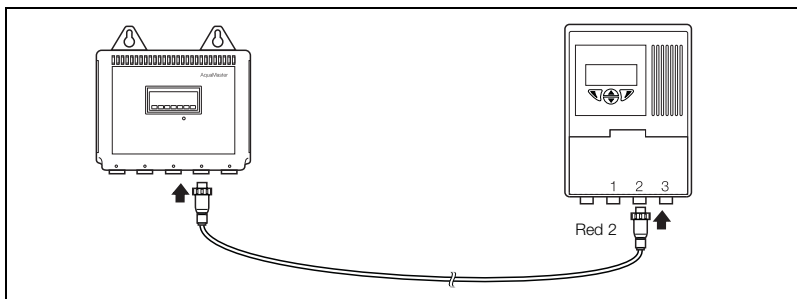

Fig. 4.21 Fitting Transmitter Leads

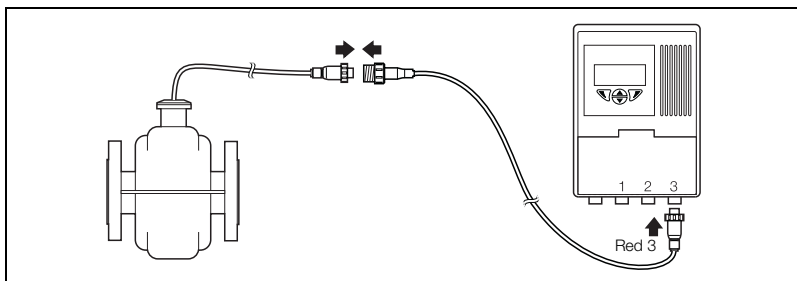

Fig. 4.22 Fitting Sensor Leads

To test an AquaMaster Explorer, see Section 5, page 28.

## 4.5 AquaMaster 3 Connections

### 4.5.1 Remote-Mounted Transmitter

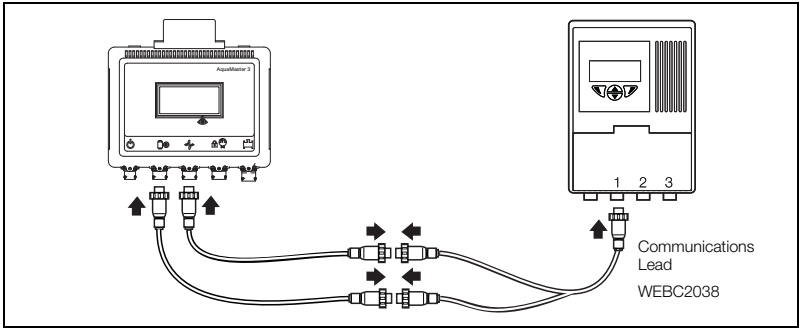

Fig. 4.23 Fitting Communications Leads

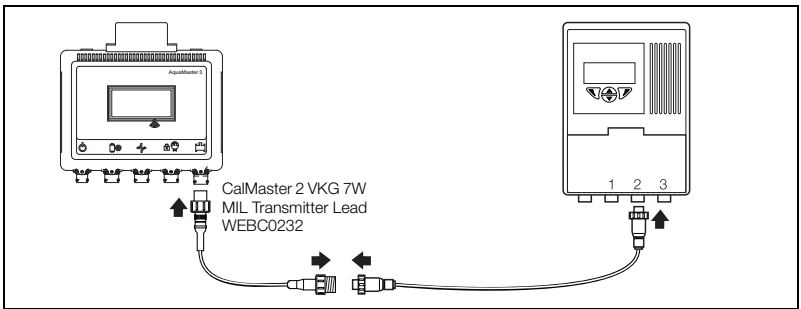

Fig. 4.24 Fitting Transmitter Leads

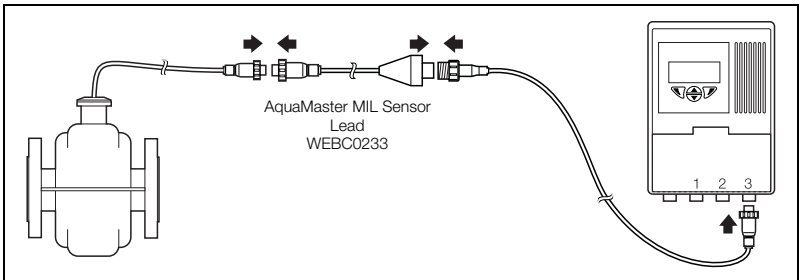

Fig. 4.25 Fitting Sensor Leads

### 4.5.2 Integral Transmitter

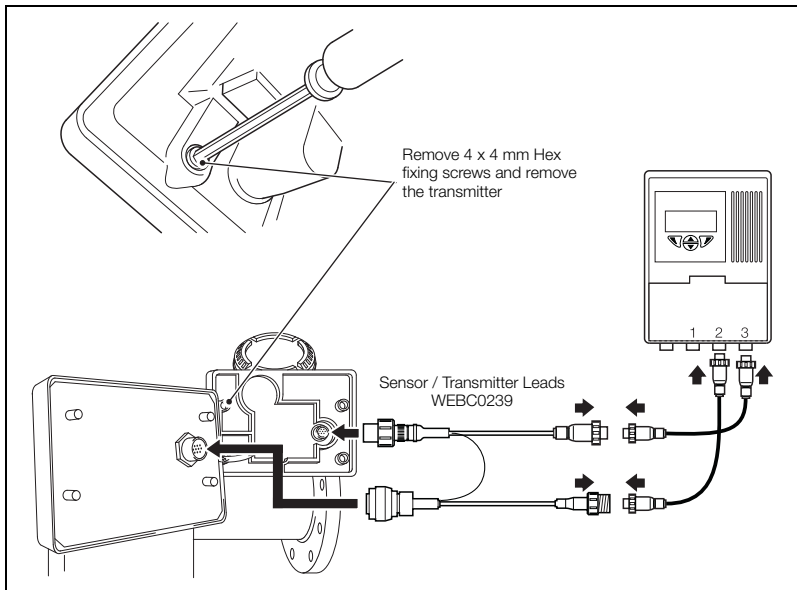

Fig. 4.26 Fitting Communications Leads

To test an AquaMaster 3, see Section 5, page 28.

## 5 Testing

### 5.1 Testing a Flow Metering System

The CalMaster2 can hold the test results of up to 100 flow meters.

The contrast of the LCD screen can be adjusted by pressing the ▲ and ▼ buttons.

**Note.**

- If there is insufficient battery charge to completely a test, CalMaster2 does not start the test. Recharge the CalMaster2 – see Section 7, page 48.
- If the ambient temperature is greater than the specified operating temperature of 50°C (122°F), the tests are failed.
- Before using the CalMaster2 ensure that the flow metering system has been isolated from any integrated system – for example, current loops and telemetry.

To perform a test:

1. Connect the CalMaster2 to the flow metering system – see Sections 4.2 to 4.4.
2. Disconnect communications lead 1.
3. Press the 'On' button. The initialization screen appears followed by a connection screen:

```
---< Connection >---  
Connect new?  
Exp:359 Mem:1.0%  
Ok Contrast
```

**Note.** 'Exp' is the number of days remaining before the licence expires.

4. The CalMaster2 attempts to connect to the flow measuring system. Select 'Ok'.
5. Reconnect communications lead 1.
6. Once the connection has been established a prompt appears to select whether the pipe is full:

```
---< Connection >---  
Is pipe full?  
Yes No
```

**Note.** When verifying an AquaMaster the pipe must always be full.

7. Select **Yes** or **No**. A prompt appears to test the analog outputs:

```
---< Connection >---  
Check analogue outputs  
Yes No
```

8. Select 'Yes' or 'No'. A prompt appears to test the pulse outputs:

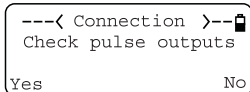

9. Select 'Yes' or 'No'. A series of self-calibration screens appear. These ensure that the CalMaster2's reference calibration, battery and data integrity are acceptable. The Connection complete screen appears:

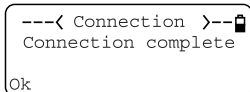

10. Select 'Ok'. CalMaster2 starts the AutoTest sequence:

**Note.** The first time CalMaster2 tests a flow meter that does not have an associated fingerprint file, it must find a valid test that can be used as a reference. A screen appears stating that CalMaster2 is searching for a reference test.

For each test there are three possible results:

- **Test Passed:**  
No action is necessary.
- **Test Failed:**

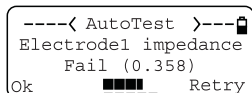

**Note.** This screen appears for 10 seconds before proceeding automatically to the next test.

1. Select 'Retry'.
2. If the test fails again, either press 'Retry' to test again or 'Ok' to continue to the next test.

- **Test Marginal:**

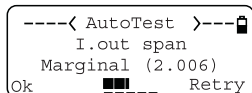

**Note.** This screen appears for 10 seconds before proceeding automatically to the next test.

1. Select 'Retry'.
2. If the test fails again, either press 'Retry' to test again or 'Ok' to continue to the next test.

11. After each test a status screen appears:

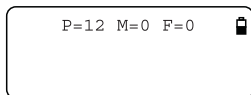

This displays a count of the number of tests that have passed, are marginal or have failed. It can also be used as a progress indicator as there are between 24 and 26 tests (depending on the selection made).

12. Once all the tests are complete, the initialization screen appears. Disconnect the flow metering system and either connect a new system (start the process again from step 3) and press 'Ok' or wait two minutes for the CalMaster2 to shut down automatically.

## 5.2 Connecting CalMaster2 to a Computer

### Caution.

- If there is insufficient battery charge to completely a download there is a chance that the CalMaster2 will shutdown automatically before a download is complete. If this happens the test is corrupted and lost. Recharge the CalMaster2 – see Section 7, page 48 and reset the CalMaster2 – see Section 6.4.1, page 36.
- CalMaster2 switches off automatically after two minutes unless it is downloading verifications. To switch on, disconnect the mains adaptor, press the 'On' button and then reconnect the mains adaptor.

Connect the CalMaster2 to the computer using the RS232 cable provided – see Fig. 5.1. It is recommended that the CalMaster2 is connected to the power supply while downloading – see Section 7, page 48.

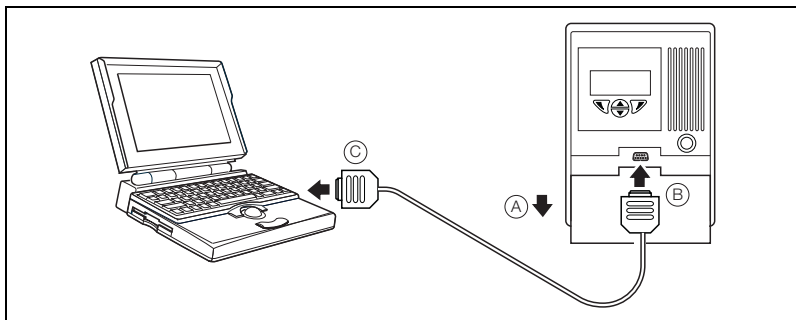

Fig. 5.1 Connecting the CalMaster2 to a Computer

To connect CalMaster2 to a computer:

1. Slide the cover (A) down to reveal the serial port.
2. Connect the RS232 cable to the CalMaster2 (B).
3. Connect the RS232 cable to the computer (C).



### 5.3 Downloading Verifications

For full details of the CalMaster2 IRIS Software see Section 6, page 32.

To Download Verifications:

1. Start the CalMaster2 IRIS software. The CalMaster2 Wizard appears:

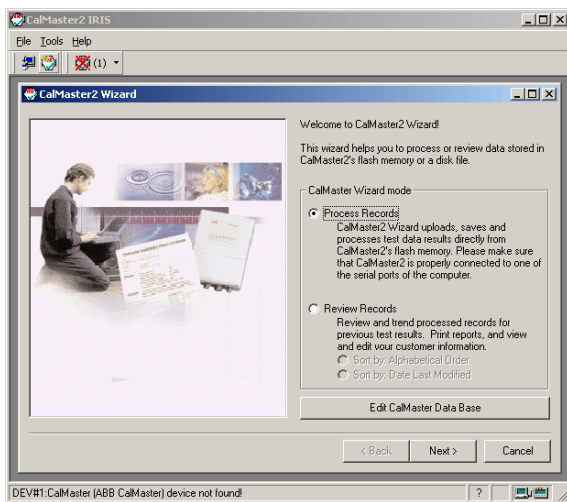

2. Select 'Process Records' and click 'Next'.
3. Follow the instructions for processing records – see Section 6.4.1, page 36.

**Note.** Once the verifications have been downloaded, the CalMaster2 does not need to be connected to be able to use it to view, organize and print reports of the verifications.

## 6 CalMaster2 IRIS Software

### 6.1 Introduction

CalMaster2 IRIS for Windows is a Microsoft Windows-based communications and verification program for ABB Flow Meters. The program communicates with the CalMaster2 via an RS232C serial cable.

A CalMaster2 Certificate is produced when further analysis has been carried out on the test results. This includes Initial and/or FingerPrint comparison analysis using Fuzzy Logic routines. In order to generate a certificate, a software password is required.



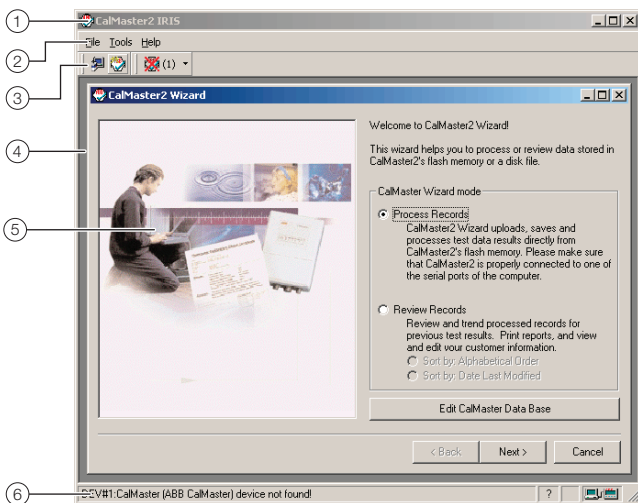

**Note.** Fuzzy Logic is a problem-solving control system methodology that provides a simple way to arrive at a definite conclusion based upon vague, ambiguous, imprecise, noisy, or missing input information.

### 6.2 CalMaster2 IRIS Interface

To open CalMaster2, either select **Start | Programs | ABB | CalMaster2 | CalMaster2**, or double-click the CalMaster2 IRIS shortcut icon on the desktop. The application window appears:



CalMaster2 automatically detects whether a CalMaster2 is connected to the computer and displays the details in the status bar.

- 
- ① **Header Bar**  
Displays the title of the current view.
  - ② **Menu Bar**  
Provides access to all the menus for the CalMaster2 application – see Section 6.3, page 34.
  - ③ **Toolbar**  
The toolbar buttons provide quick access to the CalMaster2 functions:  
**Icons**
    -  Install Factory Files.
    -  CalMaster2 Wizard.
    -  Connection present.
    -  Connection not present.
  - ④ **Application Area**  
The main application window.
  - ⑤ **CalMaster2 Wizard**  
The CalMaster2 Wizard appears automatically when the software is launched – see Section 6.4, page 35.
  - ⑥ **Status Bar**  
The status bar displays the connection details of the CalMaster2.

### 6.3 CalMaster2 IRIS Menus

Menu	Description
<b>File</b>	
Factory Files...	CalMaster2 verification can be made to within 1% of the original factory test results – see Section 6.6, page 42.
Exit	Closes CalMaster2.
<b>Tools</b>	
Device Wizard...	Used to configure the connection to the CalMaster2 – see Section 6.5, page 40.
CalMaster2 Wizard...	Opens the CalMaster2 wizard dialog box – see Section 6.4, page 35.
Languages	Changes the CalMaster2 language.
<b>Help</b>	
Contents...	Opens the contents page of the on-line help.
Index...	Opens the CalMaster2 on-line help index.
Search...	Opens the CalMaster2 on-line help search facility.
Support	Creates an e-mail addressed to ABB Technical Support.
ABB Home Page	Opens the ABB home web page.
Register CalMaster2...	Displays the registration details.
About CalMaster2...	Displays the CalMaster2 software version.

## 6.4 CalMaster2 Wizard

The CalMaster2 Wizard is used to:

- **Process Records** — download verifications from a CalMaster2.
- **Review Records** — examine verifications that have already been downloaded.
- **Edit CalMaster2 Database** — lists/edits the flow meters and CalMaster2s used.

To open the CalMaster2 Wizard:

1. Either select 'Tools | CalMaster2 Wizard...' or click the  button. The CalMaster2 Wizard dialog box appears:

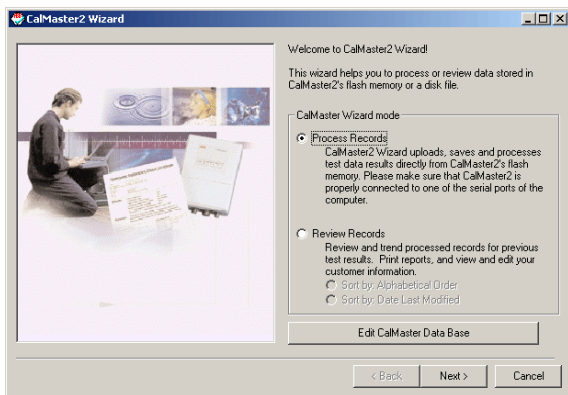

2. Select:

**Process Records** – see Section 6.4.1, page 36.

**Review Records** – see Section 6.4.2, page 37. Records can be sorted in either alphabetical or date order.

**Edit CalMaster2 Database** – see Section 6.9, page 47.

### 6.4.1 Process Records



Process Records is used to extract the verifications from a connected CalMaster2. The Process Records dialog box appears when selected from the CalMaster2 Wizard – see Section 6.4, page 35.

To open the process records dialog box, click the  button to start the CalMaster2 wizard, select 'Process Records' and click 'Next'.

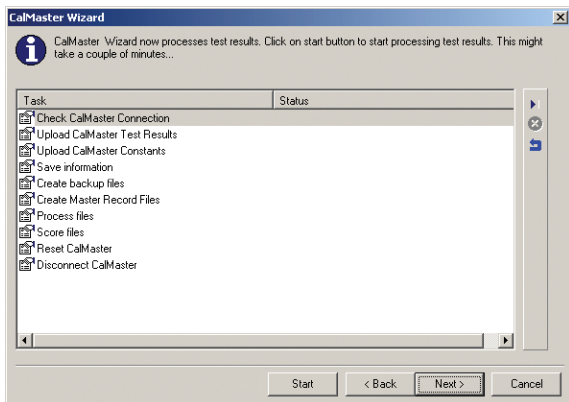
This dialog box displays a list of the tasks required to download verifications from a CalMaster2:



#### Icons

-  Start processing records.
-  Cancel processing records.
-  Reset the CalMaster2. **Note.** All Verifications are erased.

To process records:

1. Ensure the CalMaster2 is switched on.
2. On the right-hand side, click the  button to start the download process.

**Note.** This process could take a few minutes to complete. A progress bar appears at the bottom of the dialog box. As the download process proceeds, each task is highlighted in turn. To cancel the process, click the  button.

3. At the Reset CalMaster2 task, a prompt appears asking whether the CalMaster2 is to be reset. Select either 'Yes' to delete all verifications held in the CalMaster2 or 'No' to leave the verifications in place.

**Note.** The CalMaster2 can hold the test results of up to 100 flow meters.

4. Once the download process is complete click 'Next'. The Review Records dialog box appears – see Section 6.4.2, page 37.

### 6.4.2 Review Records

Review Records is used to review the results of the downloaded verifications as well as to print conformance reports and verifications. It is also used to view graphical representations of the verification results.

There are two ways of opening the Review Records dialog box:

- It appears automatically after processing records – see Section 6.4.1, page 36. The records are sorted in alphabetical order.
- Click the  button to start the CalMaster2 wizard, select 'Review Records' and click 'Next'.

Records can be sorted in either alphabetical or date order.

The Review Records dialog box has two tabs – CheckMaster and CalMaster2. Depending on your licence, one of these tabs may be disabled.

The right-hand toolbar has three buttons. Depending on your licence, one or more of these buttons may be disabled:



Print a Conformance Report

see Section 6.7, page 43.



Print a Verification Certificate

see Section 6.7, page 43.





Trend Analysis

see Section 6.8, page 44.



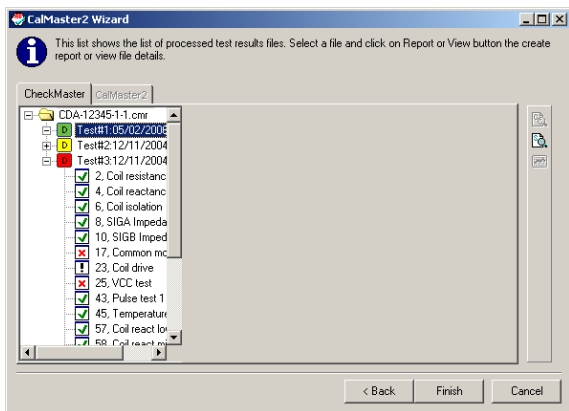

## CheckMaster

This tab is available only if you have a licence for CheckMaster.





Verifications are listed in the left-hand pane. To print a conformance report click the  button – see Section 6.7, page 43.

### Icons

-  The first verification that has passed. This is used as the benchmark for all other verifications.
-  Verifications that have passed.
-  Verifications that are marginal or have passed but near the limits of the Fuzzy Logic (see page 32).
-  Verifications that have one or more failed tests

Each verification can be expanded to display the individual tests. The results of each test are displayed in the right-hand pane. Individual tests are marked as:

-  Passed.
-  Marginal.
-  Failed.



## CalMaster2

This tab is available only if you have a licence for CalMaster2.

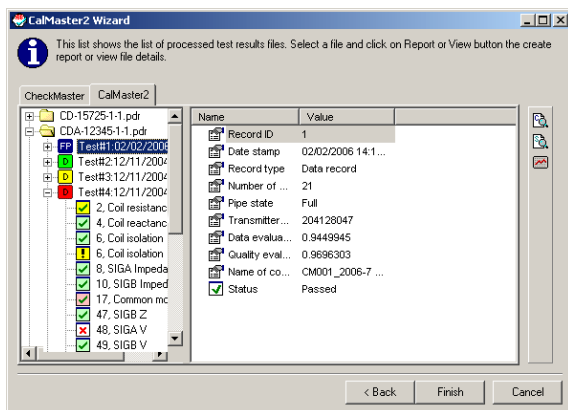

### Icons

- FP** If a flow meter's factory file has been installed (see Section 6.6, page 42), the first test in the list is the Factory file. This lists all the parameters at the time that the flow meter was manufactured.
- D** Verifications that have passed.
- D** Verifications that have one or more failed tests.
- D** Verifications that are marginal or have passed but near the limits of the fuzzy-logic.



Each verification can be expanded to display the individual tests. The results of each test are displayed in the right-hand pane. Individual tests are marked as:

- Passed.
- Passed, although the fuzzy logic is marginal.
- Passed, although the fuzzy logic has failed.
- Failed, although the fuzzy logic has passed.
- Failed, although the fuzzy logic is marginal.
- Failed, and the fuzzy logic has failed.
- Marginal.

## 6.5 Transmitter Wizard

The transmitter wizard is used to configure the connection to the CalMaster2.





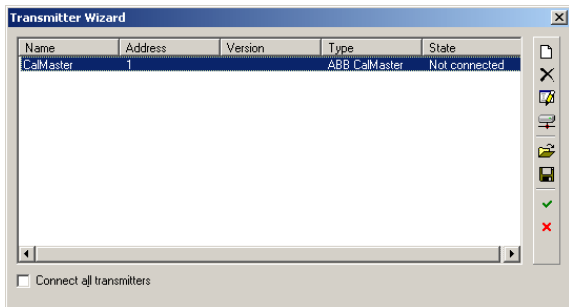



To open the Transmitter Wizard:

Either select 'Tools | Transmitter Wizard...' or click the down arrow next to the  button on the toolbar and click the  button. The transmitter wizard dialog box appears:



Each configured CalMaster2 is displayed in the list.

The right-hand toolbar has five buttons:

-  New      Opens the add New/Edit Configuration dialog box – see Section 6.5.1, page 41.
-  Delete      Deletes the selected configuration.
-  Edit      Opens the selected configuration
-  Connect      Connects to CalMaster2.
-  Open      Opens a saved device configuration file.
-  Save      Saves the selected device as a configuration file.
-  Ok      Closes the dialog box using the selected connection.
-  Cancel      Closes the dialog box without making any changes.

**Note.** If the 'Connect all transmitters' check-box is selected, when the button is clicked the computer attempts to connect to all the listed configurations.

### 6.5.1 New/Edit Configuration

This is used to configure the associated serial port connection for the CalMaster2.

**Transmitter properties**

**General**

Name:

Address:

Type:

Version:

**Communication**

Port:

Settings:

Protocol:

Use tag as transmitter name

Search at all defined Baud Rates

OK

Cancel

## 6.6 Factory Fingerprint Files

Factory Fingerprint files are used only for CalMaster2.

When a flow meter is manufactured it is tested extensively and calibrated. The calibration verification results are stored as a fingerprint file that can be obtained from the ABB web site:

<http://www.abbregister.com>

The advantage of using fingerprint files is that, by comparing the original factory test results with the CalMaster2 verification, certification can be made to within 1% of the original factory test results. If fingerprint files are not available, verification is made to within 2%.

A flow meter's fingerprint file needs to be installed once only. It is stored within CalMaster2 IRIS software database so that it is available whenever a verification is processed for that flow meter.

To install a flow meter's fingerprint file:

1. Either select 'File | Install Factory File...' or click the  button. The fingerprint files dialog box appears:

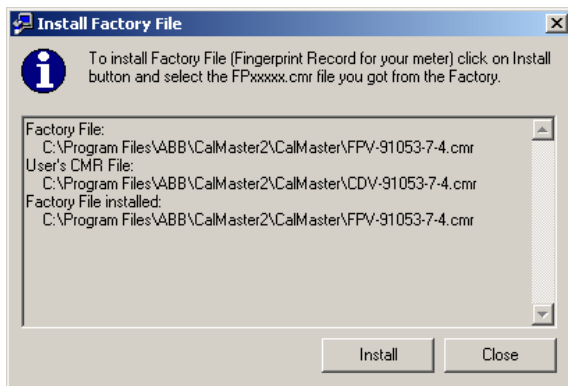

2. Click 'Install'. A file browser appears, locate the FPxxxx-x-x.pdr and click 'Open'. The factory fingerprint file is installed and appears in the list and is now available for verifications for that flow meter.



**Note.** Ensure that the fingerprint is installed before carrying out any field verifications. Failure to do this produces a 2% certificate.



## 6.8 Trend Analysis

The trend analysis graph displays how the flow meter has performed over time. Each time a flow meter is verified the results are stored and compared to previous verifications. In this way a visual representation of the flow meter's performance is generated. At a glance, it can be seen whether the flow meter's performance is deteriorating and, if so, plan appropriate maintenance at a convenient time.

To start trend analysis:

1. Click the  button to start the CalMaster2 wizard, select 'Review Records' and click 'Next'.
2. On the right-hand side of the Review Records dialog box, click the  button. The trend analysis dialog box appears:

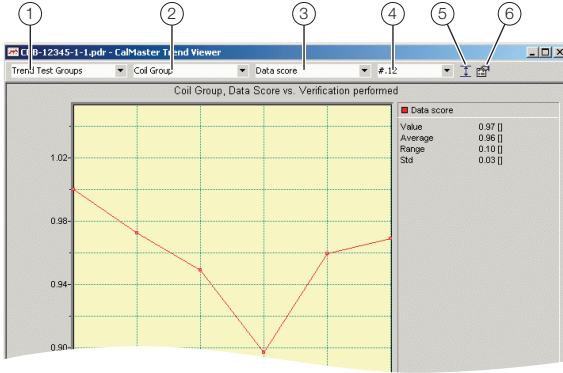

The graph functions are:

- 1 **Group/Individual Tests**  
Select whether to display an individual test or a group of tests.
- 2 **Test**  
Select the test to be displayed.
- 3 **Graph Type**  
Select the type of graph to be displayed. Options are: Data, Quality, Data Score and Quality Score.
- 4 **Number of Decimal Places**  
Select the number of decimal places to be displayed.
- 5 **Show/Hide Trend Limits**  
If selected, this displays horizontal lines delimiting the upper and lower trend limits.
- 6 **Graph Options**  
This opens the graph options dialog box – see sections 6.8.1 to 6.8.4.

**Note.** To zoom into any area of the graph click and drag a box in the graph area. Double-click to zoom out.

### 6.8.1 Scale Tab

Controls the default scale for the graph.

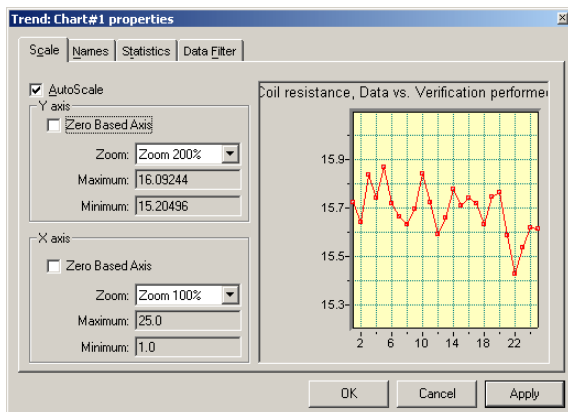

### 6.8.2 Names Tab

Controls the color and labeling for the graph.

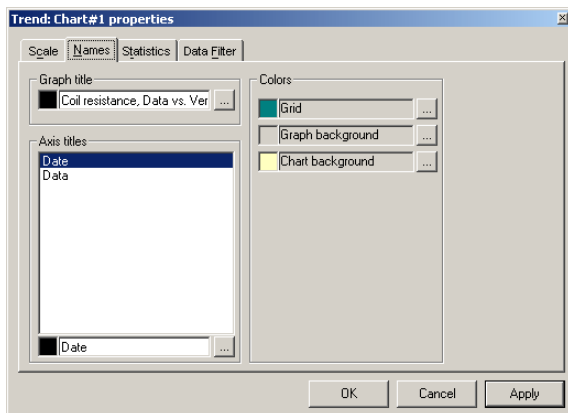

### 6.8.3 Statistics Tab

Displays basic statistics of the selected flowmeter.

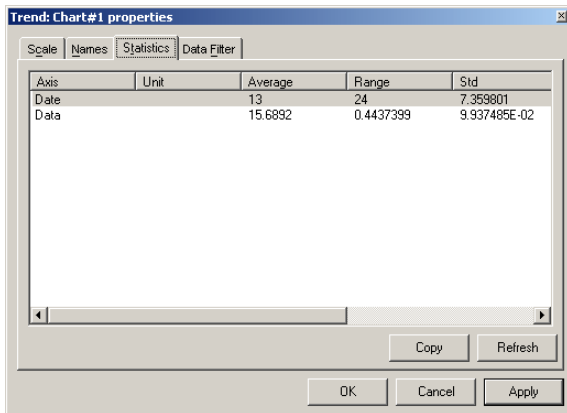

### 6.8.4 Data Filter Tab

Forces the results to ignore any zero values.

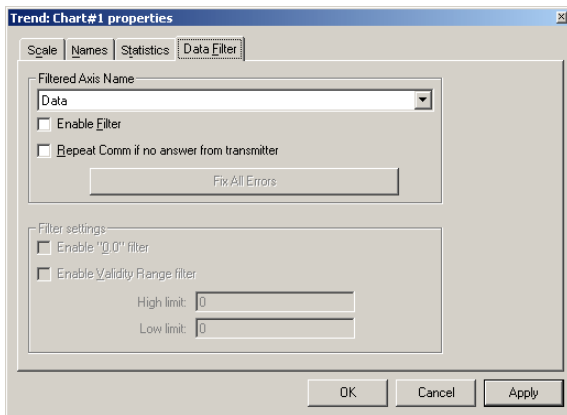



## 6.9 CalMaster2 Database

The CalMaster2 database enables data to be recorded about each CalMaster2 and flowmeter.

To open the CalMaster2 database:

1. Click the  button to start the CalMaster2 wizard.
2. Click 'Edit CalMaster2 Database...' the CalMaster2 Database Browser appears:

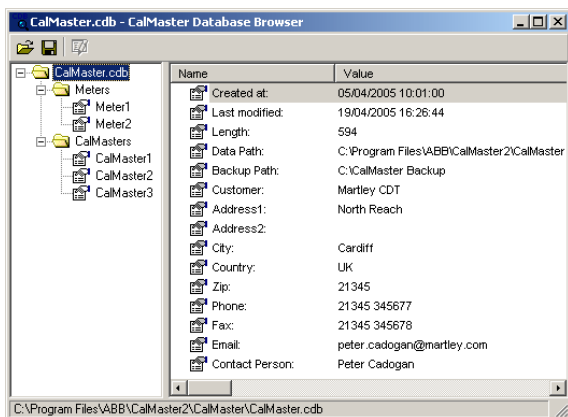

The Database, Meters and CalMaster2s are listed in the left-hand pane. The details for the selected item are displayed in the right-hand pane.

To edit a detail, either double-click the detail selected or click the  button. Type the new information and press Enter.

To open an alternate database click the  button.

To save any changes, click the  button.

## 7 Recharging CalMaster2

CalMaster 2 incorporates an intelligent charger that features fast, high and low current charge modes. The unit switches automatically from high current to low current charge mode when the required battery voltage is reached.

CalMaster2 must be recharged after use for at least four hours. With a full charge, CalMaster2 can verify a minimum of six flow meters before needing to be recharged.

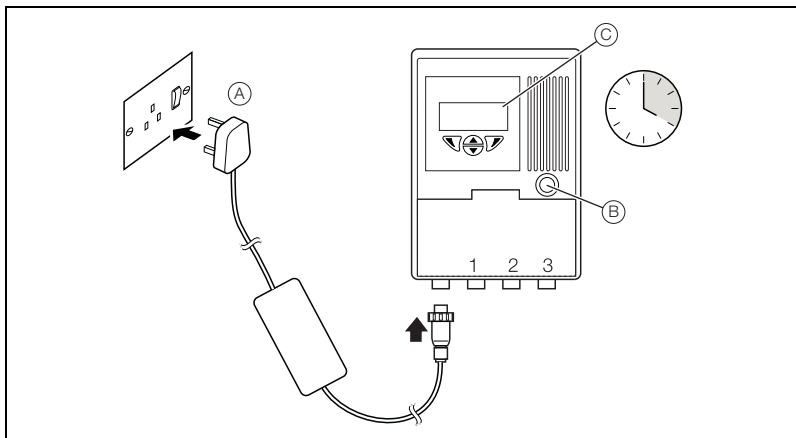



Fig. 7.1 Recharging the CalMaster2

To recharge CalMaster2:

1. Plug in the universal mains adaptor (A) – see Fig. 7.1.
2. Press the 'On' button (B). Failure to do this results in slow and partial charging of the battery.
3. Correct connection is confirmed by the mains icon in the top right corner of the display (C).
4. The display shows the normal start-up screen (  ). After a short time period with no activity, this screen times out. If at this stage the CalMaster 2 determines that a fast-charge is necessary, the display shows the text 'Fast Charging x.xV', otherwise, the display switches off (enters sleep mode) immediately.
5. If fast-charging mode was engaged, once the required battery voltage is reached the unit switches fast-charge off automatically and the display switches off. Pressing the 'On' button (B) starts the CalMaster 2.
6. Typical charge periods are about 4 hours.
7. CalMaster 2 can be used during charging by pressing the button labelled 'Stop' on the display, followed by the 'On' button (B). Leave the charger connected. In this mode, charge times are extended.

## 8 Registration

In order to download fingerprint files to the CalMaster2, each flow meter must be registered.

To register:

1. Open a web browser and type <http://www.abbregister.com> in the address bar. The ABB log-in page appears.

The screenshot shows the ABB Product Registration Service web form. At the top left is the ABB logo. Below it, the text reads "Welcome to the ABB Product Registration Service" and "Thank you for purchasing an ABB Product. New users please register below:". On the right side, there is a section for "Already Registered?" with a "Login below to register another product:" link, a "Username:" field, a "Password:" field, and a "Submit" button. Below this is a link for "Forgot your username or password?" and another link to "Click here to visit the ABB Instrumentation website". The main registration form consists of several fields, each marked with an asterisk to indicate it is required: Title (Mr, Mrs, etc.), First Name, Surname, Gender (dropdown), Organisation Name, Job Title, Business Type (dropdown), Address 1, Address 2, Address 3, City / Town, County / State, Postcode / ZIP Code, Country (dropdown), E-mail, Telephone, and Product Type (dropdown). At the bottom, there is a checkbox for "I give permission for you to use my email under the terms set out below:" and a paragraph of text explaining that ABB will only communicate relevant information to the user and their business. Below this is a "Direct Mail" checkbox and an "Email" checkbox. A "Next" button is located at the bottom left of the form.

2. Complete the form and press 'Next'. An e-mail response is sent containing the Username and Password.

The registration for the selected product appears:

### CalMaster2 Registration

\* Required field

Product Type: **CalMaster2**

\* Serial No. :

\* Date of Purchase:  /  /  (DD/MM/YYYY)

3. Type the **Serial number** and **Date of Purchase**. A confirmation appears:

**Note.** If the date of purchase is not known, use the date of installation.

### Confirmation of registration submission

Thankyou, the registration for your new product has been submitted successfully.

**Registration details:**

**Product Type:**  
**Serial Number:** 1234  
**Date of Registration:** 26/08/2002

[Click here](#) to view your registration details.

4. Click the link to view registration details.

### Your Details

Welcome Steven Dickson

Please choose from the list below:

[View / Edit your personal details](#)  
[View current registrations](#)  
[Register another product](#)

## 8.1 Registering Flowmeters

Each flow meter must be registered with ABB – see Section 8, page 49.

To register a flow meter:

1. Open the web browser and type <http://www.abbregister.com> in the address bar. The ABB log-in page appears:



**Already Registered ?**  
Login below to register another product:

Username

Password:

Forgot your username or password? - [Click here](#)

2. Type the 'Username' and 'Password' and click 'Submit'. The registration details page appears:

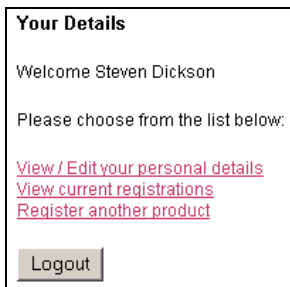

**Your Details**

Welcome Steven Dickson

Please choose from the list below:

[View / Edit your personal details](#)  
[View current registrations](#)  
[Register another product](#)

3. Click the 'Register another product' link.
4. Select the 'Product type' from the drop-down list and click 'Next'. The details page appears:

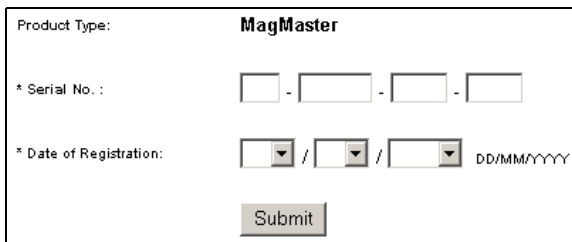

Product Type: **MagMaster**

\* Serial No. :  -  -  -

\* Date of Registration:  /  /  DD/MM/YYYY

5. Type the 'Serial Number' and 'Date of Purchase'. Click 'Submit'. A confirmation page appears. An e-mail response is sent with the product details provided.

## 8.2 Downloading Fingerprint Files

When a flow meter is manufactured it is tested extensively and calibrated. The calibration results are stored as a fingerprint file. Fingerprint files are available for all registered flow meters.

To download fingerprint files the flow meter(s) must be registered with ABB – see Section 8, page 49.

To download fingerprint files:

1. Open a web browser and type 'http://www.abbregister.com' in the address bar. The ABB log-in page appears:

**Already Registered ?**  
Login below to register another product:

Username

Password:

Forgot your username or password? - [Click here](#)

2. Type the 'Username' and 'Password' and click 'Submit'. The options page appears:

**Your Details**

Welcome Steven Dickson

Please choose from the list below:

[View / Edit your personal details](#)

[View current registrations](#)

[Register another product](#)

3. Click View current registrations. A list of registered products appears:

**ABB**

---

**Existing Registrations**

Current product registrations for Steven Dickson at ABB Limited.

Product Type	Description	Serial Number	Edit Serial Number	Date of Purchase	Fingerprint Download	Certificate Download
CallMaster2	CallMaster 2	X/10144/1/1	<a href="#">Edit Serial Number</a>	5.12.2005	Not Applicable	Not Applicable
AquaMaster	AquaMaster Meter	G-15725-1-1	<a href="#">Edit Serial Number</a>	30.11.2005	<a href="#">Click Here</a>	<a href="#">Click Here</a>
MagMaster	MagMaster Meter	P-12345-1-1	<a href="#">Edit Serial Number</a>	26.9.2005	<a href="#">Click Here</a>	<a href="#">Click Here</a>
CallMaster2	CallMaster 2	V/CM004	<a href="#">Edit Serial Number</a>	15.7.2005	Not Applicable	Not Applicable

1 - 4 of 4 Registrations

Pages: [ 1 ]

4. Click the link for the required flow meter. A File Download dialog box appears.
5. Click 'Save'. A file browser appears prompting for a location for the download. Browse to:  
'C:\Program Files\CalMaster2\Factory Files\Fingerprints'.
6. Click 'Save'.
7. Install the fingerprint file – see Section 6.6, page 42.

## Appendix A CalMaster2/CheckMaster Clock Utility

Included with the CalMaster2 IRIS software is a utility that enables the CalMaster2 or CheckMaster clock to be synchronized with a PC.

To run the utility:

1. Connect the CalMaster2 to the PC – see section 5.2, page 30.
2. From the Windows 'Start' menu select 'Run...'.  
3. Type: 'C:\Program Files\ABB\CalMaster2\Clock.exe' or click 'Browse' to locate the file. The utility appears:

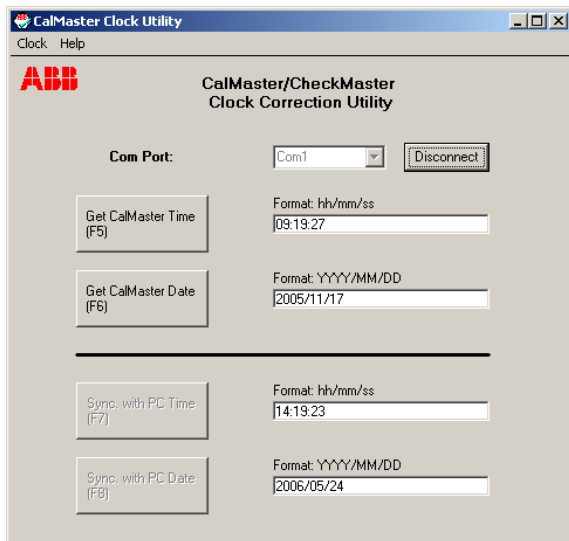

4. Select the COM port that the CalMaster2 is connected to.
5. Click the 'Get CalMaster Time' button or press F5.
6. Click the 'Get CalMaster Date' button or press F6.
7. Click the 'Sync with PC Time' button or press F7.
8. Click the 'Sync with PC Date' button or press F8. The CalMaster2/CheckMaster now uses the same date and time as the PC.



## Notes



## Products and customer support

### Automation Systems

For the following industries:

- Chemical & Pharmaceutical
- Food & Beverage
- Manufacturing
- Metals and Minerals
- Oil, Gas & Petrochemical
- Pulp and Paper

### Drives and Motors

- AC and 6 Drives, AC and DC Machines, AC Motors to 1kV
- Drive Systems
- Force Measurement
- Servo Drives

### Controllers & Recorders

- Single and Multi-loop Controllers
- Circular Chart and Strip Chart Recorders
- Paperless Recorders
- Process Indicators

### Flexible Automation

- Industrial Robots and Robot Systems

### Flow Measurement

- Electromagnetic Flowmeters
- Mass Flowmeters
- Turbine Flowmeters
- Wedge Flow Elements

### Marine Systems & Turbochargers

- Electrical Systems
- Marine Equipment
- Offshore Retrofit and Refurbishment

### Process Analytics

- Process Gas Analysis
- Systems Integration

### Transmitters

- Pressure
- Temperature
- Level
- Interface Modules

### Valves, Actuators and Positioners

- Control Valves
- Actuators
- Positioners

### Water, Gas & Industrial Analytics Instrumentation

- pH, Conductivity and Dissolved Oxygen Transmitters and Sensors
- Ammonia, Nitrate, Phosphate, Silica, Sodium, Chloride, Fluoride, Dissolved Oxygen and Hydrazine Analyzers
- Zirconia Oxygen Analyzers, Katharometers, Hydrogen Purity and Purge-gas Monitors, Thermal Conductivity

### Customer support

We provide a comprehensive after sales service via a Worldwide Service Organization. Contact one of the following offices for details on your nearest Service and Repair Centre.

#### UK

ABB Limited  
Tel: +44 (0)1453 826 661  
Fax: +44 (0)1453 829 671

#### USA

ABB Inc.  
Tel: +1 215 674 6000  
Fax: +1 215 674 7183

#### Client Warranty

Prior to installation, the equipment referred to in this manual must be stored in a clean, dry environment, in accordance with the Company's published specification.

Periodic checks must be made on the equipment's condition. In the event of a failure under warranty, the following documentation must be provided as substantiation:

- A listing evidencing process operation and alarm logs at time of failure.
- Copies of all storage, installation, operating and maintenance records relating to the alleged faulty unit.

## Contact us

### **ABB Limited**

#### **Process Automation**

Oldends Lane  
Stonehouse  
Gloucestershire GL10 3TA  
UK  
Tel: +44 1453 826 661  
Fax: +44 1453 829 671

### **ABB Inc.**

#### **Process Automation**

125 E. County Line Road  
Warminster  
PA 18974  
USA  
Tel: +1 215 674 6000  
Fax: +1 215 674 7183

[www.abb.com](http://www.abb.com)

### Note

We reserve the right to make technical changes or modify the contents of this document without prior notice. With regard to purchase orders, the agreed particulars shall prevail. ABB does not accept any responsibility whatsoever for potential errors or possible lack of information in this document.

We reserve all rights in this document and in the subject matter and illustrations contained therein. Any reproduction, disclosure to third parties or utilization of its contents in whole or in parts – is forbidden without prior written consent of ABB.

Copyright© 2015 ABB  
All rights reserved

IM/VC/M2 Rev. J 03.2015