

AT100/AT100S Magnetostrictive Level Transmitter

High accuracy
magnetostrictive level
transmitter for total and
interface level measurements

K-TEK Level products

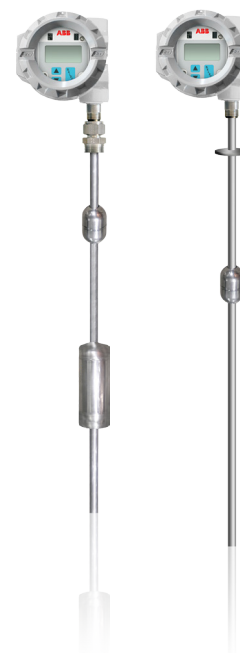

Introduction

The AT100 is based upon the magnetostrictive principle. The sensing tube contains a wire, which is pulsed at fixed time intervals and the interaction of the current pulse with the magnetic field created by the magnetic float. This causes a torsional stress wave to be induced in the wire. This torsion propagates along the wire at a known velocity from the position of the magnetic float and toward both ends of the wire. A patented piezo-magnetic sensing element placed in the transmitter assembly converts the received mechanical torsion into an electrical return pulse. The microprocessor-based electronics measures the elapsed time between the start and return pulses and converts it into a 4-20 mA output, which is proportional to the level being measured.

TABLE OF CONTENTS

1.0 INTRODUCTION	4
2.0 STORAGE INFORMATION	5
3.0 INSTALLATION AND BASIC WIRING	5
3.1 All Installations.....	5
3.1.1 Compression Fittings.....	5
3.1.2 Floats.....	5
3.1.3 Transmitter Housing Height.....	5
3.2 Stilling Probes.....	5
3.2.1 Assembly Instructions for F1 Flexible Probes.....	6
3.3 Loop Wiring.....	6
3.4 Jumper Settings.....	6
4.0 TRANSMITTER CALIBRATION AND SETUP	7
4.1 Level Output Calibration.....	7
4.1.1 Calibration Using the Pushbuttons.....	7
4.2 Reversing Action.....	7
4.2.1 Reverse Action Calibration Using the Pushbuttons.....	7
4.3 Damping.....	7
4.4 Calibration Using the LCD Setup Menu.....	9
4.5 Selecting a Primary Variable (PV).....	9
4.6 Selecting an Engineering Unit for Measurement (EUN).....	10
4.7 Level Offsets (L1O and L2O).....	10
4.8 DAC Trim.....	10
4.9 Temperature Output.....	10
4.9.1 Selecting the Unit of Temperature (EUN TEMP).....	10
4.9.2 Temperature Output Calibration.....	11
4.9.3 Temperature Reset (TMP RSET).....	11
4.9.4 Temperature Master Calibration.....	11
4.10 Volumetric Strapping.....	12
4.10.1 How the Strapping Table Works.....	12
4.10.2 Setting Up (or resetting) the Strapping Table.....	12
4.10.3 Selecting the Input Mode (Automatic or Manual).....	12
4.10.4 Setting Up Strapping Table Points.....	13
4.10.5 Notes on Strapping Table Usage.....	13
4.10.6 Saving/Loading a Strapping Table.....	13
4.10.7 Setting Current Output Based on Volume.....	13
4.11 Alarm Delay.....	1
4.12 Custom Current Ranging.....	14
4.12.1 Description and Method of Operation.....	14
4.12.2 CCR Set Up.....	14
5.0 COMMUNICATION OPTIONS	15
5.1 Hart Protocol Interface Option.....	15
5.1.1 Using a 268/275/375 Rosemount Communicator or Equal.....	15
5.2 Honeywell DE Protocol.....	15
5.2.1 Interoperability and Conformance Class.....	15
5.2.2 Operating Modes.....	15
5.3 Foundation Fieldbus.....	16
5.3.1 Topology.....	16
5.3.2 Electrical Considerations.....	16
5.3.3 Field Wiring.....	17
5.3.4 Jumper Settings.....	17
5.3.5 DD Files.....	17
5.3.6 Transducer Block.....	17
5.3.7 AI Function Blocks.....	17

TABLE OF CONTENTS (continued)

5.3.8 PID Blocks	18
5.3.9 Link Active Scheduler / Back-up LAS	18
5.3.10 Threshold Adjustment.....	18
5.3.11 Sample Configurations	18
6.0 SAFETY, MAINTENANCE, & TROUBLESHOOTING	19
6.1 Personnel Qualifications	19
6.2 Required Tools	19
6.3 Suggested Proof Test.....	20
6.4 Safety Inspection	20
6.4.1 Float Inspection	20
6.4.2 Sensor Inspection.....	21
6.4.3 Transmitter Testing	21
6.4.4 Output Checkout.....	21
6.5 4-20mA, HART Transmitters.....	23
6.6 Foundation Fieldbus Transmitters.....	24
6.7 Verify Proper Power Up of the Transmitter	25
6.8 Verify Current Output Stability.....	25
6.9 Threshold Adjustment	26
6.10 Module Replacement.....	26
6.11 Terminal Strip Checkout.....	26
6.12 Threshold Adjustment Using an Oscilloscope.....	27
7.0 NAMETAG INFORMATION	28
8.0 WIRING DIAGRAMS.....	29
8.1 FM/CSA.....	29
8.2 ATEX/IEC	31
8.3 Typical Loop Wiring Diagram	33
8.4 Loop Powered TX Hookup /RI Dual Compartment Housing.....	34
8.5 Temperature Simulation Wiring Diagram	35
9.0 /F1 OPTION ASSEMBLY DRAWING	36
10.0 SIL CERTIFICATE	37
11.0 EU DECLARATION OF CONFORMITY.....	39
12.0 WARRANTY STATEMENT	40

1.0 INTRODUCTION

ABB AT100 transmitters are used extensively around the world to accurately measure level in process vessels. High accuracy and no maintenance are two of the most common reasons for choosing this technology. With optional ratings to 800°F (427°C) and 3000 PSI (207 bar), ABB's Magnetostrictive Level Transmitters are suitable for almost any application. HART, Honeywell DE, and Foundation Fieldbus Protocol options make our AT100's easy to connect digitally to most control systems. LCD displays provide indication as 4-20mA, %, and other engineering units.

When used on Storage Tanks, concerns of high accuracy, low maintenance and reasonable cost leads customers to install flexible probe versions of the AT100's in their storage tanks. With the ability to be easily installed to a maximum of 75 feet (23 meters), almost any liquid storage application can be handled. Some common liquids include water, acids, caustics, propane, ammonia, oils, fuels, chemicals, and waste liquids. An optional internal 20-segment increment table allows the AT100 to provide volumetric output in vertical cylinder, horizontal cylinder or spherical vessels (See Section 4 for details on the Volumetric Strapping Table).

ABB's AT100's can be used as "Displacer Replacers". Most Liquid Level Displacers in dynamic processes have seen many repetitive problems in operation including the following: extreme errors in output due to specific gravity changes, leaks around the torque tube penetration, and low or stuck readings due to product buildup on the torque tube or displacer. AT100's can be inserted into the existing Displacer Chambers or a new External Chambers to solve the listed problems. Tremendous improvements in accuracy will be realized. Additionally, this is an extremely easy way to update pneumatic Displacer Transmitters.

The Magnetostrictive Level Transmitter (AT100) can be used to measure the level of interface between two fluids. The AT100 is the finest technology available for liquid level interface measurement and control. ABB AT100's can be equipped to provide two (2) level indications: one for interface and a second for total level. Designs are available for differences of specific gravity down to 0.04 differences. Most commonly applied to oil and water separator interface, this technique is used in many process applications. Others include HF acid / propane vessels, de-salters and sumps.

The AT100 can be used as a Valve Positioner by utilizing the AT100's non-contact style of measurement. A magnet is attached to the valve stem and the AT100 is located along side the valve stem. The inherent 0.01% high accuracy in our AT100 transmitter allows exceptionally fine control and measurement of valve position. ABB's AT100's never need to be re-calibrated ensuring accurate and precise control. The AT100 can also be used as an Equipment Positioner. Industrial facilities require accurate positioning of equipment. This can be accomplished with Magnetostrictive (non-contact measurement). It has been applied to many devices including gates, louvers, dampers, and hydraulic cylinders. ABB advantages of push button configuration, 4-20mA output, and heavy duty construction ensure ease of installation and a long trouble free life.

Finally, the AT100 can be used in various Sanitary Applications including the Bio-Tech, Pharmaceutical and Food Industries. A range of surface finishes are available to suit the needs of the process environment including electro-polishing.

Based on the Functional Safety Assessment of Exida, the AT100 transmitter is suitable for use in a Safety Instrumented Function requiring a SIL 2 risk reduction in single use and a SIL 3 risk reduction in redundant use with a Hardware Fault Tolerance of 1.

Only transmitters meeting all of the following requirements may be used in a Safety Instrumented Function:

- Transmitters fitted with a 4-20 mA output HART protocol /M4A or /M4B or /M4AS or /M4BS Electronic Module.
- Modules marked as follow: AT_H_01_S003_090209 or AT_H_TS_01_S003_090209 (Transmitters equipped with software revision of AT_H_090209 or AT_H_TS_090209 and a hardware revision 01).

2.0 STORAGE INFORMATION

If required, storage prior to installation should be indoors at ambient temperature, not to exceed the following:

Temperature range: -40°- 150°F (-40°- 66°C)

Humidity: 0 to 95% R.H. non-condensing.



WARNING: Transmitter probes with /SW3 option have a flexible stainless steel sensor tube which is not hermetically sealed. When removing the sensor from the sensor well, care should be taken not to expose the sensor to moisture, and to prevent water from entering the sensor well.

3.0 INSTALLATION AND BASIC WIRING

3.1 All Installations

Prior to installation, verify the model of the transmitter listed on the nametag is suitable for the intended application. Information regarding the model specifications may be found on the AT100 Datasheet at www.ktekcorp.com.

3.1.1 Compression Fittings

When fitted with a compression fitting as the process connection, the sensor tube is shipped with a set of TEFLON ferrules, and a set of metal ferrules in a separate bag. The Teflon ferrules are only intended for use in applications with operating pressures below 50 PSI (3.4 bar) and temperatures below 400°F (204°C.); for higher operating pressures or temperatures or for permanent installation, replace the Teflon ferrules with the metal ferrules.

3.1.2 Floats

During installation, it may be necessary to remove the float and spacer (if included) from the sensor tube. For proper operation, the float must be reinstalled using the proper orientation. Floats may be marked with “Top for SPM” or “Top for AT”, this end of the float must face the transmitter head. Other floats may be marked with an arrow indicating the proper orientation. If a float is etched with information but does not indicate a proper orientation, it will be bidirectional and can be installed in either direction. If a float does not have any markings (sanitary applications) it will have an extra rolled seam to indicate the top half of the float.

3.1.3 Transmitter Housing

Once installed, the top of the transmitter housing will extend above the process connection based on the particular model number. The extension of the probe on some of the options is required to keep the transmitter electronics within its safe operating environment not to exceed:

Temperature range: -40°- 150°F (-40°- 66°C)

Humidity: 0 to 95% R.H. non-condensing.

Option	Height
H0	7.75 inches (197 mm)
H1, F1	14.75 inches (375 mm)
H2, H3	24.75 inches (629 mm)

3.2 Stilling Probes

Certain transmitter options will have the sensor tube inserted into a stilling probe. These options allow the sensor tube and housing to be removed for service without breaking the seal on the vessel. These options include (consult model number) SW1, SW2, SW3 and F1.

Model	Sensor Type	Stilling Probe
SW1	1/2" rigid	5/8" tube
SW2	5/8" rigid	3/4" pipe (typical)
SW3	1/2" flexible stainless	5/8" tube
F1	5/8" flexible plastic	1" sectional tube

The compression fittings which hold the sensor inside the stilling probe will contain Teflon ferrules. It is not necessary to change the Teflon ferrules to metal. This connection will not be required to hold pressure.

3.0 INSTALLATION AND BASIC WIRING

3.2.1 Assembly Instructions for F1 Flexible Probes

Refer to Appendix B for /F1 Option Assembly Drawing

1. Prepare joints #2 and #3 by lubricating the O-Ring and mating surface.
2. Lower the bottom tube section with the float stop and float into the tank.
3. Insert the top of the tube assembly through the mounting flange.
4. Add the next section of tube and thread together using thread locking fluid to secure joints.
5. Repeat step 4 for each middle tube sections.
6. Add the last section (TOP) of tube, with 1" compression fitting, and thread into assembly using thread locking fluid to secure the joint.
7. Thread the tube compression fitting into the mounting flange using thread sealant.
8. Lower the tube assembly until it hits the bottom of the tank. Raise the sensor well back up ½" and secure the assembly in place by tightening the tube compression fitting.



WARNING: When handling flexible tube, do not bend any section of the tube into a diameter of less than 4 ft., as this could permanently damage the internal assembly and prevent proper operation.

9. Insert the flexible probe into the tube assembly. Secure flexible probe assembly to stainless steel tube using 1" tube to 1" tube compression fitting.



WARNING: Insure that assembly is tight and properly sealed to prevent moisture entry.

3.3 Loop Wiring

Remove the test wires shipped with the transmitter. For field wiring, use 18 Gauge twisted shielded pair. Please refer to included wiring diagram (Section 8.0). Electrical connection to the transmitter should comply with all necessary standards as indicated by the area classification listed on the nameplate of the transmitter (Section 7.0).

Apply loop power to transmitter as follows:

Terminal Block +	:	+24 VDC (14-36 VDC)
Terminal Block - (METER)	:	COMMON
Terminal Block METER	:	Not used during normal operation
Ground screw	:	GROUND

- Ground wires must be connected to ground screws using fork terminals to ensure proper electrical connection.
- The current output of the transmitter is capable of driving a minimum of 250 ohms with a supply voltage of 19 Volts minimum.



WARNING: A multi-meter may be placed between the METER positions of the terminal block to read the current output of the transmitter without breaking the loop wiring. Do not connect multi-meter to METER test positions when instrument is located in a hazardous environment.

3.4 Jumper Settings

The jumpers located on the face of the electronics module (top left hand side) can be setup as follows:

See Section 6.11

- ALARM (Fail Safe): (left jumper)
 - The Alarm jumper will determine the output of the transmitter in the event that there is a failure in detecting the return signal from the sensor tube. This jumper should be set in the location which will send the control structure into a safe state.
 - Placing the jumper to the lower position causes the output to go to 20.99 mA when there is a loss of signal or transmitter malfunction.
 - Placing the jumper to the upper position causes the output to go to 3.61 mA when there is a loss of signal or transmitter malfunction.
- WRITE PROTECT (right jumper)
 - When the jumper is in the lower position, the transmitter configuration cannot be changed via the pushbuttons or with a handheld communicator.

For changes to the jumper settings to take effect, transmitter power must be turned OFF then back ON.

4.0 TRANSMITTER CALIBRATION AND SETUP

4.1 Level Output Calibration

The AT100 is a digital transmitter with no routine calibration required. If re-calibration is required, calibration can be changed using the module pushbuttons, a HART communicator (for units with the HART option), or with the menu driven LCD readout (for units with LCD option).

4.1.1 Calibration Using the Pushbuttons

- Setting the 4mA point:
 - Establish a tank level of 0% or move the float to the desired 0% point
 - Enter the calibration mode by pressing the UP & DOWN buttons together for 1 second.
 - Press the DOWN button for 1 second to set the output at 4.00mA.
- Setting the 20mA point:
 - Establish a tank level of 100% or move the float to the desired 100% point
 - Enter the calibration mode by pressing the UP & DOWN buttons together for 1 second.
 - Press the UP button for 1 second to set the output at 20.00mA.

Note: The above steps can be repeated as many times as required

4.2 Reversing Action

If required, transmitter output can be reversed by following these steps (Note: this only reverses the 4-20 mA output, not the Engineering Unit Readout)

4.2.1 Reverse Action Calibration Using The Pushbuttons

1. Adjust the tank level to 50% or move the float to the 50% point (+ or - 10%).
 - Enter the calibration mode by pressing the UP & DOWN buttons together for 1 second and press the DOWN button for 1 second to set the output at 4.00 mA.
2. Adjust the level or move the float to the new SPAN (20.00mA) point.
 - Enter the calibration mode by pressing the UP & DOWN buttons together for 1 second and press the UP button for 1 second to set the output at 20.00 mA.
3. Adjust the level or move the float to the new ZERO (4.00mA) point.
 - Enter the calibration mode by pressing the UP & DOWN buttons together for 1 second and press the DOWN button for 1 second to set the output at 4.00 mA.

Note: Procedures 4.1.1 and 4.2.1 will only change the calibration for the selected Primary Variable.

4.3 Damping

Damping helps to reduce the affects of rapid or irregular movement of the fluid level in a tank or vessel. Adjustments to Damping will either increase or decrease the time required for the transmitter output to respond to changes in input from the sensor tube. A higher number allows for more output stability. A lower number will provide a quicker response. The maximum response time to a process change will be less than 110 milliseconds or the value of the Damping, whichever is greater. The factory default setting for Damping is 0.8 seconds.

- The output damping amount can be changed as follows:
 - Press the SELECT and UP buttons together for 1 second to double the damping value.
 - Press the SELECT and DOWN buttons together for 1 second to divide the damping value by 2.
- The Damping value may also be adjusted in the Calibration Menu on transmitters equipped with an LCD Display. The Damping is adjustable from 0 to 36 seconds.

AT100 Menu Flow Chart

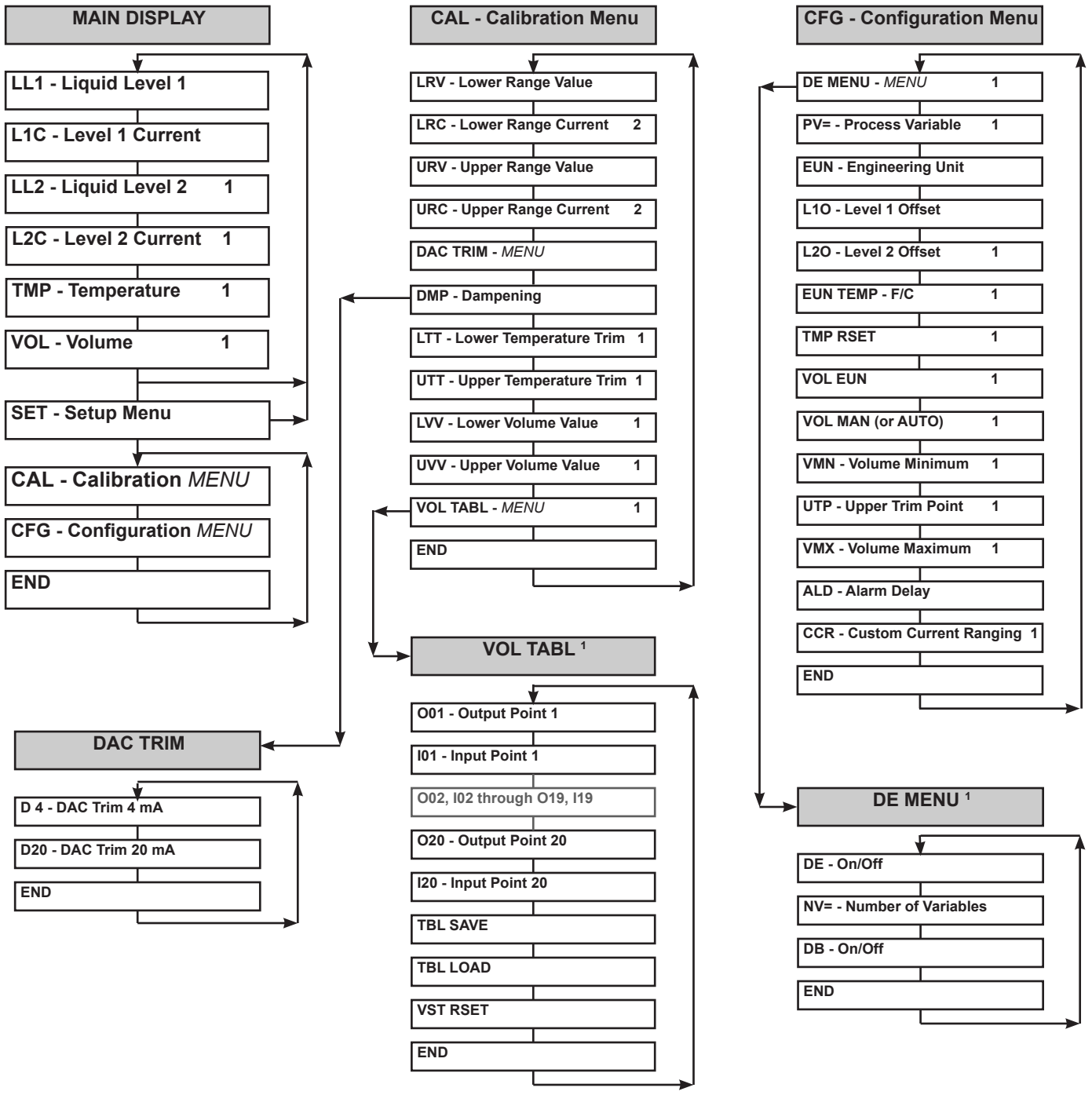

- To access a menu item press the SELECT button.
 - Use the UP and DOWN buttons to scroll through each menu and change the value of digits and menu entries.
- Notes:
- These items will only appear based on the ordered options of the transmitter.
 - Current ranging works only on Level (LU). Even though selected, volume uses 4-20mA.

4.0 TRANSMITTER CALIBRATION AND SETUP

Electronics Without
LCD Display



Electronics With LCD
Display



4.4 Calibration Using the LCD Setup Menu

The LCD Display option offers a menu driven setup that uses the UP, DOWN and SELECT pushbuttons. Refer to the menu flow chart for navigation and selection instructions.

- Setting the 4mA point:
 - Under the CAL menu, scroll DOWN to the LRV (Lower Range Value) menu option. Press SELECT to change the value (in Engineering Units) for which the 4mA point is to be set.
- Setting the 20mA point:
 - Under the CAL menu, scroll DOWN to the URV (Upper Range Value) menu option. Press SELECT to change the value (in Engineering Units) for which the 20mA point is to be set.

Note: The above steps can be repeated as many times as required. This procedure will only change the calibration for the selected Primary Variable.

4.5 Selecting a Primary Variable (PV)

This section applies to dual-float transmitters only.

For a dual-float transmitter, the primary variable (LL1 or LL2) defines the float used to calculate current (mA) output. If the primary variable is set to LL1, current output will be determined by the position of the float nearest the transmitter housing. Alternately, if PV is set to LL2, current will correlate to the float farthest from the transmitter.

- Selecting the Primary Variable
 - Under the SET menu, access the CFG menu, then go to the PV= menu option.
 - Press SELECT, then press UP or DOWN to cycle between LL1 and LL2 (the LCD will be blinking with your selection).
 - When the LCD is displaying the intended selection, press SELECT once more to set PV (the display should stop blinking).

Note: If the Primary Variable is changed, it may be necessary to reset the 4 and 20 mA calibration points.

4.0 TRANSMITTER CALIBRATION AND SETUP

4.6 Selecting an Engineering Unit for Measurement (EUN)

The unit is capable of displaying level output in inches, feet, millimeters, centimeters, meters, or in percent of range.

- Selecting an Engineering Unit
 - Under the CFG menu, go to the EUN menu option.
 - Press SELECT, then press UP or DOWN to cycle between engineering units.
 - When the LCD is displaying the intended unit, press SELECT once more to set the engineering unit (the display should stop blinking).

Note: Due to 4 digit display limitations on the display, if 9999mm will be exceeded, the metric engineering units must be changed to cm.

4.7 Level Offsets (L1O and L2O)

Level Offsets can be utilized to make the indicated level on the transmitter match the actual level in your tank or vessel. This is typically used to compensate for an un-measurable area at the bottom of the vessel. The Level Offsets can also be utilized to make the indicated level on the AT transmitter match the indicated level of another transmitter. Positive offsets will be added to the actual level of the transmitter to indicate a higher level. Conversely, negative offsets will indicate lower levels.

- Changing the Level Offset
 - Navigate to the L1O (Level 1 Offset) menu option.
 - Press SELECT to change the value (in Engineering Units) of the level offset to be applied.
 - For dual-float units, Level 2 can be offset via the above steps with the L2O menu option.

4.8 DAC Trim

The output of the AT100 transmitters will be set up at the factory using calibrated multi-meters. Once installed, the current output received by the control system will be influenced by the available power and field wiring and may not indicate an exact 4.00 and 20.00 mA. To correct this error a DAC TRIM may be performed.

- Performing the DAC Trim
 - Under the CAL menu, scroll down to the DAC TRIM option
 - Press UP and SELECT or DOWN and SELECT to enter the DAC TRIM menu
 - At D 4 or D20 enter the current reading indicated at the control system and the transmitter will correct its output
 - Repeat each entry if needed then EXIT the menu.

4.9 Temperature Output

This section applies only to transmitters with the temperature output option. These transmitters will have module types of M5A or M5B with or without a suffix of "D" or "F".

4.9.1 Selecting the Unit of Temperature (EUN TEMP)

The unit will display temperature in either Celsius or Fahrenheit degrees.

- Selecting the Unit of Temperature
 - Under the CFG menu, go to the EUN TMP menu option.
 - Press SELECT, then press UP or DOWN to cycle between Celsius and Fahrenheit.
 - When the LCD is displaying the intended unit, press SELECT once more to set the temperature unit (the display should stop blinking).

4.0 TRANSMITTER CALIBRATION AND SETUP

4.9.2 Temperature Output Calibration

The transmitter is factory calibrated to an accuracy of $\pm 0.5^\circ$ Celsius, over a range of -200 to 300°C. Fine calibration and trim for a custom range can be done via the following steps:

- Setting the Lower Temperature Trim (LTT)
 - Bring the sensor (located near the bottom of the transmitter probe) to the temperature that will be the lower end of the temperature range.
 - Under the CAL menu, go to the LTT (Lower Temperature Trim) menu option. Press SELECT to change LTT to the current temperature of the sensor.
- Setting the Upper Temperature Trim (UTT)
 - Bring the sensor (located near the bottom of the transmitter probe) to the temperature that will be the upper end of the temperature range.
 - Under the CAL menu, go to the UTT (Upper Temperature Trim) menu option. Press SELECT to change UTT to the current temperature of the sensor.

Note: Trim must be within 10°C of factory calibration to be accepted.

4.9.3 Temperature Reset (TMP RSET)

If required, the unit's temperature settings (i.e. LTT and UTT) can be reset to the factory temperature calibration. To reset the unit to the factory temperature calibration, navigate to the TMP RSET menu option and press SELECT.

4.9.4 Temperature Master Calibration

The temperature indication of the AT100 will be factory calibrated from -200 to 300 degrees C. Under normal circumstances, it will not be necessary to recalibrate the temperature transmitter. If for some reason recalibration is required, the following steps will be used.

1. Disconnect the power.
2. Setup decade box per drawing in Section 8 - Wiring Diagrams
3. Set resistance to 185 ohms.
4. Apply power.
5. Set EUN TEMP to °C (Celsius)
6. Cycle through CFG menu to END.
7. At END push UP and DOWN together.
8. At FAC -200 press SELECT then UP and DOWN at the same time.
9. Scroll Down to END and SELECT.
10. Verify TMP indicates -200°C.
11. Disconnect the power.
12. Set decade box for 2120 ohms.
13. Apply power.
14. Cycle through CFG menu to END.
15. At END push UP and DOWN together.
16. Scroll down to FAC 300.
17. Press SELECT then UP and DOWN at the same time.
18. Scroll Down to END and SELECT.
19. Verify TMP indicates 300°C.
20. Disconnect the power.
21. Reconnect RTD.
22. Reapply power.

4.0 TRANSMITTER CALIBRATION AND SETUP

4.10 Volumetric Strapping

Note: For AT100 models with Strapping Table option only. If utilizing Foundation Fieldbus refer to section 4.3.5.2 for strapping table instructions.

4.10.1 How the Strapping Table Works

The AT strapping table works by using table points set up by the user. For every point, there is a volume (provided by the user) and a measurement (provided by either the user or the transmitter). These table points are used to map sensor measurement to volume output. As the float travels the length of the probe, the volume output will change based on the two points in the table closest to the given transmitter measurement. With no points in the table, the volume output is linear between VMN (volume min) at 0 measurement and VMX (volume max) at UTP (upper trim point) which equates to the highest point of float travel. As points are added, the volume output is extrapolated with respect to VMN, the table points, and VMX.

The Volumetric Table is capable of being set up in two different modes, Automatic and Manual. In Automatic mode, as a volume point is entered, the position of the transmitter float will determine the transmitter measurement associated with the volume entered. In Manual mode, as a volume point is entered, the user will be able to modify the measurement to which the volume corresponds.

The points in the table are listed sequentially on the LCD as O01, O02, I02, ... O19, I19, O20, I20. An 'O' is listed for each output point, which corresponds to volume. An 'I' is listed for each input point, which corresponds to linear measurement. If in manual mode, both output and input points will be available. In automatic mode, only output points will be shown.

4.10.2 Setting Up (or resetting) the Strapping Table

- Under the CAL menu:
 - Scroll to VOL TABL, then press SELECT.
 - Scroll up to VST RSET, then press SELECT. This will erase any table points currently set.
- Under the CFG menu:
 - Scroll down to UTP, (which stands for Upper Trim Point) and note the value listed.
 - Scroll down to VMX (Volume Maximum).
 - Enter for 0 as a value '0000', then press SELECT to reset the LCD decimal.
 - Next, enter the value of the Maximum Volume corresponding to UTP. Note: Enter only the whole number of the value, since the decimal is not present, then press SELECT.
 - After the decimal has been placed, set any digits to the right of the decimal, if available.
 - Scroll up to VMN (Volume Minimum).
 - Enter the volume of the tank at 0 measurement on the transmitter probe.

4.10.3 Selecting the Input Mode (Automatic or Manual)

- The AT transmitter provides two options for entering the values of the strapping table. The Automatic option requires the level (or float) to be at the fixed location that corresponds to the selected volumetric output point when the point is entered. If it is not possible (or feasible) for the tank level to be manipulated but a distance-to-volume conversion chart is available, the strapping table can be easily set up using Manual mode.
- Under the CFG menu:
 - Scroll down to VOL MAN or VOL AUTO (the LCD will display the current input mode).
 - To switch between modes, press SELECT.
 - Scroll UP or DOWN to change the mode.
 - Press SELECT

4.0 TRANSMITTER CALIBRATION AND SETUP

4.10.4 Setting Up Strapping Table Points

Under the CAL menu:

- 1) Scroll to VOL TABL, then press SELECT.
 - A. In manual mode, set the measured value for each Input Point and set the corresponding Output Point to the desired volume value.
 - B. In automatic mode, position the float at the desired measurement point and set the corresponding Output Point to the desired volume value.
- 2) Once the volume values and measurements are set in the table, scroll down to TBL SAVE and press select. This will save the volume table in a backup location that may be recalled later by selecting TBL LOAD.

4.10.5 Notes on Strapping Table Usage

- The volume entered for any point must be between VMN (Volume Min) and VMX (Volume Max).
- The measurement entered for any point must be between 0 measurement and UTP (Upper Trim Point).
- A point may be removed ('zeroed out') from the table by entering '0' for its output 'O##' field. If a point is zeroed out, it will be bypassed when volume output is calculated.
- A zeroed point may be set again, provided it is increasing with respect to the previous points in the table list.
- For all points in the table, all points must be increasing in volume and increasing in measurement, with the exception of zeroed points. When setting up the table, points should be set up sequentially from VMN (at 0 measurement) to VMX (at UTP);
- It is not necessary to use all of the points in the Volume Table.
- Since the table is based on VMN and VMX, any change to either of these will invalidate the table. Therefore, once the table is properly set up, DO NOT change either of these settings.

4.10.6 Saving / Loading a Strapping Table

Because setting up the strapping table can be a time-consuming process, it is possible to save a copy of the table, and also to load the table from a previous save.

- To save the current strapping table:
Under the CAL menu:
 - Scroll to VOL TABL, then press SELECT.
 - Scroll up to TBL SAVE, then press SELECT.
- To load a saved strapping table:
Under the CAL menu:
 - Scroll to VOL TABL, then press SELECT.
 - Scroll up to TBL LOAD, then press SELECT.

4.10.7 Setting Current Output Based on Volume

- If the current output is to be based on volume:
 - Under the CFG menu, scroll down to PV=.
 - Press SELECT and scroll UP or DOWN to change the PV to VL1 (Volume 1) or VL2 (Volume 2) if available. Selecting VL1 will filter the measurement from LL1 through the Volume Table, display the result as the Volume (VOL) and output the current based on this volume. Selecting VL2 will filter the measurement from LL2 through the Volume Table, display the result as the Volume (VOL) and output the current based on this volume.
 - Under the CAL menu, scroll down to LVV. Set this value to the volume that will correspond to 4mA.
 - Scroll down to UVV. Set this value to the volume that will correspond to 20mA.

Note: LVV and UVV must be within VMN and VMX.

4.0 TRANSMITTER CALIBRATION AND SETUP

4.11 Alarm Delay

The AT100 transmitter is designed to send the current output into a Fail Safe mode when the transmitter does not detect a return signal from the sensor tube or the transmitter experiences a diagnostic failure. In certain installations (such as high vibration areas) the transmitter may experience sporadic interruptions in the return signal which are not an indication of sensor tube failure. The spiking output affect caused by the interruptions can be eliminated by using the Alarm Delay feature. Increasing the Alarm Delay will cause the transmitter to hold the last good level indication (and its corresponding current output) for a period of time equivalent to the Alarm Delay value (0-99.99 seconds). If the transmitter does not detect a good return signal within this time, the output will change to the Fail Safe selected by the jumper settings. If within the Alarm Delay time frame, a good signal is detected, the transmitter will respond with a level indication and output based on the new reading and the Alarm Delay clock will reset.

- Setting the Alarm Delay:
 - Under the CFG menu, scroll DOWN to the ALD (Alarm Delay) menu option.
 - Press SELECT to access the setting.
 - Use the UP and DOWN arrows to change each digit.
 - Use the SELECT button to move from one digit to the next.

4.12 Custom Current Ranging

4.12.1 Description and Method of Operation

All AT200 transmitters are set by the factory with the LRV set to 0 measurement and the URV set to the range of the transmitter unless a specific calibration is indicated when the transmitter is ordered. In this standard configuration, the transmitter will output 4mA when the float reaches the LRV and 20mA when the float reaches the URV. Using the Level Offset (L1O) feature, the indicated measurement at this point can be changed to something other than 0 measurement. Changing the offset will not affect the output of the transmitter. The mA output will remain at 4.00 when the float reaches the zero mark on the sensor tube.

In some applications it may be necessary to have the transmitter output something other than 4.00mA with the float located at the zero mark of the sensor tube. In these cases, Custom Current Ranging (CCR) can be applied to the transmitter. CCR will allow the user to change the milliamp values associated with LRV and URV. For example, the Lower Range Current (LRC) can be set to 5.00mA. With the LRV set to 0 measurement, the transmitter will output 5.00mA and display 0 measurement. Once the LRC and URC are set, using the calibration procedures in Section 4.1.1 or 4.4 will result in the current output corresponding to LRC and URC instead of 4 and 20mA. Custom Current Ranging may not be activated if the AT100 is being used in a Safety Implemented System.

4.12.2 CCR Set Up

1. Enter the Configuration Menu (CFG).
2. Scroll down to CCR.
3. Press SELECT.
4. Scroll UP or DOWN to turn CCR ON.
5. Press SELECT.
6. Exit the CFG Menu.
7. Enter the Calibration Menu (CAL).
8. Scroll down to LRC and press SELECT.
9. Using the UP and DOWN buttons enter the digits corresponding to the mA value that will be associated with the measurement in LRV. (Press SELECT after each digit is set to move to the next digit.)
10. Scroll down to URC and press SELECT.
11. Using the UP and DOWN buttons enter the digits corresponding to the mA value that will be associated with the measurement in URV. (Press SELECT after each digit is set to move to the next digit.)
12. Exit the CAL Menu.

To revert back to standard values for LRV and URV (4 and 20 mA respectively,) turn CCR - OFF.

5.0 COMMUNICATION OPTIONS

5.1 HART Protocol Interface Option

The ABB transmitter can be ordered with the HART Protocol Option, which is installed at the factory as a part of the electronic module assembly. When fitted with the HART Protocol Option, it will be possible to communicate with the transmitter using a Rosemount 268, 275, or 375 communicator utilizing slave mode. HART communications will allow access to certain functions. This communication will not interfere in the operation of the transmitter. If the AT100 is to be used in a Safety Implemented System, HART communications can only be used to configure or proof test the transmitter.

5.1.1 Using a 268/275/375 Rosemount Communicator or Equal

Since the ABB transmitter is not a known ROSEMOUNT product, these handheld devices will communicate in the GENERIC mode. This mode allows access to the commands listed here:

- READ OR WRITE OUTPUT UPPER RANGE & LOWER RANGE VALUES
- READ OR WRITE OUTPUT DAMPING VALUE
- READ OR WRITE TRANSMITTER TAG, DESCRIPTION, MSG, DATE
- PERFORM OUTPUT DIGITAL TRIM (DAC TRIM)
- TEST LOOP OUTPUT
- SET POLLING ADDRESS

Changes to transmitter settings via HART communication must be verified by cycling power to the transmitter, reestablishing communications, and reading the values.

NOTE: If a transmitter is in an alarm condition (20.97 or 3.61 mA) or does not have a float present on the sensor tube, the handheld communicator will respond as if the transmitter had a hardware failure. If there is a float present, proceed with troubleshooting in Section 6.

5.2 Honeywell DE Protocol

5.2.1 Interoperability and Conformance Class

The Honeywell DE Protocol option uses the Honeywell proprietary Digitally Enhanced Protocol for Smart Transmitters.

The conformance class support is as follows:

The DCS configuration should be set for Class 0, 4 byte Mode.

Class 0: Continuous broadcast, in burst mode, of the following parameters:

- PV1: Primary Variable; Level #1 in %
- PV2: Secondary Variable; Level #2 in % (if equipped)
- PV status: Ok, Critical or Bad PV

The Transmitter settings should be as follows:

- DE = ON
- NPV (Number of Process Variables) = 1 or 2
- DB = OFF

5.2.2 Operating Modes

The ABB transmitter with the Honeywell DE Protocol option can be operated in two ways which can be selected using the setup menu on the instrument. (See section 3.2.2 Calibration using the LCD Setup Menu.)

- **DE Digital Mode:** In this mode the transmitter output is strictly digital and uses the Honeywell DE Protocol which modulates the loop current ON and OFF to transmit digital information per above Class Performance definition.
- **Analog Output Mode:** Selecting the Analog Output Mode disables the Honeywell DE Digital Output and places the transmitter in a standard 4-20mA Output mode. In this mode, no digital communications are available.

5.0 COMMUNICATION OPTIONS

5.3 Foundation Fieldbus

5.3.1 Topology

The device may be installed in either a Bus or Tree topology.

Bus Topology

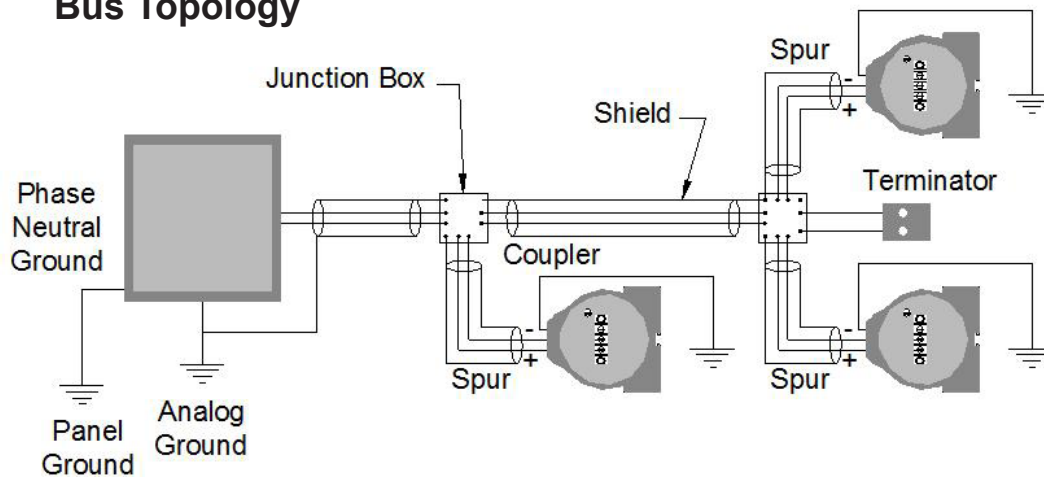

Tree Topology

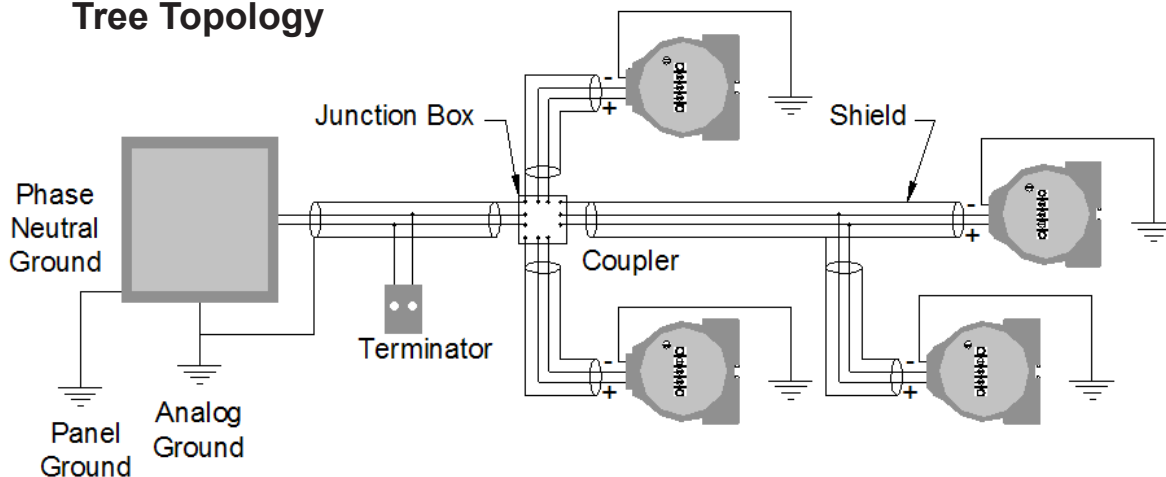

5.3.2 Electrical Considerations

Power Supply:

- The transmitter requires between 9 and 32 V dc to operate and provide complete functionality. The DC power supply should provide power with less than 2% ripple.
- Various types of Fieldbus devices may be connected on the same bus.
- The AT is powered via the bus. The limit for such devices is 16 for one bus (one segment) for non-intrinsically safe requirement. In hazardous area, the number of devices may be limited by intrinsically safe restrictions. The AT is protected against reverse polarity, and can withstand ± 35 VDC without damage.

Power Filter:

A Fieldbus segment requires a power conditioner to isolate the power supply filter and decouple the segment from other segments attached to the same power supply.

5.0 COMMUNICATION OPTIONS

5.3.3 Field Wiring

All power to the transmitter is supplied over the signal wiring. Signal wiring should be a shielded, twisted pair for best results. Do not run unshielded signal wiring in conduit or open trays with power wiring or near heavy electrical equipment.

If the sensor is installed in a high-voltage environment and a fault condition or installation error occurs, the sensor leads and transmitter terminals could carry lethal voltages. Use extreme caution when making contact with the leads and terminals.

Quiescent Current Consumption: 12.5mA.

Communication Mode: H1 (31.25Kbit/s Voltage Mode Signaling). All other devices on the same bus must use the same signaling. 12 to 16 devices can be connected in parallel along the same pair of wires.

5.3.4 Jumper Settings

The Jumpers are located on the face of the electronic module (top left hand side) can be setup as follows:

- WRITE PROTECT (right jumper) See Document ELE1002
- When the jumper is in the lower position, the transmitter configuration cannot be changed via the LCD.
- SIMULATE (left jumper) See Document ELE1002
- The simulate jumper is used in conjunction with the Analog Input (AI) function block. This switch is used to simulate channel output, and as a lock-out feature for the AI function block. To enable the simulate feature, move the jumper to the lower position on the module housing.

5.3.5 DD Files

The incorporation of the AT100 transmitter in a control system will require the use of specific DD files within the host system. These files may be downloaded from www.fieldbus.org.

5.3.6 Transducer Block

The Transducer Block contains transmitter specific data regarding the setup, configuration, and indication of the instrument. Under normal circumstances it will not be necessary to change any of the parameters in the Transducer Block. The process data is expressed in the Transducer Block as the following:

LEVEL_VALUE_1: Level 1
LEVEL_VALUE_2: Level 2 *
TEMPERATURE_VALUE: Temperature *
LIN_VALUE_1: Linearization/Strapping Output, Level 1 *
LIN_VALUE_2: Linearization/Strapping Output, Level 2 *
* = Depending on options selected when ordering

5.3.7 Analog Input (AI) Function Blocks

The AT transmitter comes configured with 5 AI Function Blocks. Depending on the specific model, each block can be used to access 1 of the 5 possible Transducer Block output values. The AI Blocks take data from the Transducer Block and make it available to other blocks. To select the desired data, configure the AI.CHANNEL parameter as follows:

AI.CHANNEL = 1: Level 1
AI.CHANNEL = 2: Level 2 *
AI.CHANNEL = 3: Temperature *
AI.CHANNEL = 4: Linearization/Strapping Output, Level 1 *
AI.CHANNEL = 5: Linearization/Strapping Output, Level 2 *
* = Depending on options selected when ordering

5.0 COMMUNICATION OPTIONS

5.3.8 PID Blocks

The AT transmitter is equipped with 5 PID (Proportional, Integral, Derivative) Blocks. These blocks can be used to implement control algorithms within the transmitter. The output of the PID Block can be linked to the AO (Analog Output) Block of another instrument like a valve or to the input of another PID Block.

5.3.9 Link Active Scheduler / Back-up LAS

The AT transmitter is designed as a Link Master (LM) class device. With this feature, the instrument can become a fully functioning Link Active Scheduler (LAS) in the event that the primary LAS (typically the host system) fails. The device must be configured as the Link Master to take advantage of this functionality.

5.3.10 Setting Up the Strapping/Linearization Table (Requires /S option)

The Linearization/Strapping table is configured via the LIN_LENGTH, LIN_X, and LIN_Y parameters of the Transducer Block. To configure the table, set the LIN_LENGTH parameter to the number of desired table points (1-26). The input to each point should then be set to a LIN_X value, and the output to each point should be set to a LIN_Y value. Note: The Linearization table can only be configured when the Transducer Block is set to Out of Service (TRANSDUCER.MODE_BLK.ACTUAL=OOS).

5.3.11 Sample Configurations

5.3.11.1 Level Indication in Percent

A simple application of the AT100 transmitter will be to return a level indication as a percentage. With a desired range of 48 inches of level, the following configuration could be used:

```
AI.L_TYPE must be "INDIRECT" (to use XD_SCALE->OUT_SCALE mapping)
AI.XD_SCALE.EU_0 = 0 (in)
AI.XD_SCALE.EU_100 = 48 (in)
AI.XD_SCALE.UNITS_INDEX="in"
AI.OUT_SCALE.EU_0 = 0 (%)
AI.OUT_SCALE.EU_100 = 100 (%)
AI.OUT_SCALE.UNITS_INDEX = "%"
```

5.3.11.2 Offsetting a Measurement

Using the same example in section 1, the level indication can be changed to return an offset measurement instead of a percentage using the following configuration:

```
AI.L_TYPE must be "INDIRECT" (to use XD_SCALE->OUT_SCALE mapping)
AI.XD_SCALE.EU_0 = 0 (in)
AI.XD_SCALE.EU_100 = 48 (in)
AI.XD_SCALE.UNITS_INDEX="in"
AI.OUT_SCALE.EU_0 = 12 (in)
AI.OUT_SCALE.EU_100 = 60 (in)
AI.OUT_SCALE.UNITS_INDEX = "in"
```

6.0 SAFETY, MAINTENANCE, AND TROUBLESHOOTING

The AT100 will operate normally without the need for periodic maintenance or inspection. If the transmitter meets or exceeds the requirements of the application, the transmitter can be expected to provide reliable level indication for a minimum of 10 years.

If the AT100 transmitter is being used as part of a Safety Implemented System (SIS), periodic testing will be required to proof the transmitter and detect any potential failure which is defined as Dangerous Undetectable in normal operation. Proof testing must be performed at regular intervals (2 years) and the results of this testing must be documented. Should the transmitter exhibit a fault during normal operation, it will be necessary to perform the proof testing regardless of schedule. As part of the testing documentation, all parameters included in the menu structure of the transmitter (see page 8) as well as the configuration of the module jumpers (see page 6) must be recorded. An AT100 can be equipped to provide a level indication from two floats as well as a temperature indication from an RTD installed in the sensor tube. The transmitter is only capable of supplying (1) 4-20mA output based on one of the two possible levels. If a transmitter is equipped with more than one float and/or a temperature indication, only the process variable selected by the PV= menu option will be considered as a safety function as this selected variable will be the basis for the 4-20mA output. The AT100 transmitter may only be used in a safety-related system when the mode of that system is low demand. As a device, the AT100 transmitter will be used to provide a level measurement to prevent overflow and dry run of a vessel.

If a transmitter fails an inspection or assistance is required for inspection or troubleshooting, contact the Service Department at ABB via e-mail at service@ktekcorp.com. The Service Department will answer questions, provide additional assistance, and issue Return Authorization Numbers for equipment in need of repair.

CAUTION: In the event a magnetostrictive transmitter has suffered a failure in any component which is exposed to the process, any other magnetostrictive transmitter installed in the same or similar process should be inspected for the same failure regardless of its maintenance schedule. These Common Cause Failures include: 1) float collapse due to over pressure, 2) probe or float corrosion due to material incompatibility, 3) deformation of the sensor tube due to process agitation.

Notes on usage in Safety Instrumented Systems:

1. The AT100 performs internal diagnostics at a maximum interval of 15 minutes.
2. The AT100 will provide annunciation of a diagnostic failure in less than 15 minutes of the occurrence.
3. The failure of any internal diagnostics will result in notification of the fault by setting of diagnostic bits in HART protocol output.
4. All AT100 FMEDA analysis is based on using a safety accuracy of 2%.
5. The internal diagnostics are designed to achieve a Safe Failure Fraction of 90% minimum.
6. The target average probability of failure on demand is less than 1.5×10^{-3} .
7. AT200 transmitters may only be used in a SIS when:
 - a) Transmitters are fitted with a 4-20 mA output HART Protocol /M4A or /M4B or /M4B or /M4AS or /M4BS Electronic Module
 - b) Modules must be marked as follows: AT_H_01_S003_090209 or AT_H_TS_01_S003_090209

6.1 Personnel Qualifications

Safety Inspection, Maintenance and Troubleshooting should only be performed by qualified personnel. These qualifications include a knowledge of the information in this instruction manual, knowledge of the product and its operating principles, knowledge of the application in which the transmitter is being applied, and general experience as an Instrument Technician.

Before, during and after performing Safety Inspection, Maintenance or Troubleshooting it will be necessary to observe and adhere to any safety standards, practices or requirements defined in the policies of the end user.

6.2 Required Tools

The following tools may be required to perform inspection, maintenance or troubleshooting of the AT100 transmitter.

- Crescent Wrench
- Screwdrivers
- Hex Key Wrenches
- Digital Multi-meter
- Tape Measure
- Portable Oscilloscope (optional)
- Oscilloscope Connector (purchased from ABB) or three pieces 26awg solid core wire (6in/150mm)

6.0 SAFETY, MAINTENANCE, AND TROUBLESHOOTING

6.3 Suggested Proof Test

The suggested proof test consists of minimum and maximum current capability test followed by a two-point calibration of the transmitter, see the suggested proof test Table. This test will detect > 99% of possible DU failures in the device.

AT100 Suggested Proof Test Table	
Step	Action
1.	Bypass the safety function and take appropriate action to avoid a false trip.
2.	Use HART communications to retrieve any diagnostics and take appropriate action.
3.	Send a HART command to the transmitter to go to the high alarm current output and verify that the analog current reaches that value ¹ .
4.	Send a HART command to the transmitter to go to the low alarm current output and verify that the analog current reaches that value ² .
5.	Perform a two-point calibration ³ of the transmitter over the full working range.
6.	Remove the bypass and otherwise restore normal operation.
Notes: 1. This tests for compliance voltage problems such as a low loop power supply voltage or increased wiring resistance. This also tests for other possible features. 2. This tests for possible quiescent current related failures. 3. If the two-point calibration is performed with electrical instrumentation, this proof test will not detect any failures of the sensor.	

6.4 Safety Inspection & Test

An AT100 transmitter can be divided up into four major components the float, the sensor, the transmitter, and the output. All of these components and their subcomponents should be evaluated during each periodic inspection. This inspection (and possible repair) should take less than 4 hours if the proper tools are made available. Prior to inspection, the transmitter should be removed from service following end user specified procedures regarding lockout, tag out, wiring and cleaning. Once removed from service, the AT100 transmitter should be laid on a flat even surface.

6.4.1 Float Inspection

The AT100 will detect and report the position of the float on its sensor tube as a level of fluid in the process. In order to measure the fluid in the process properly, the float must move freely up and down the sensor tube partially submerged in the liquid level. If the float were to become damaged or stuck on the sensor tube, the transmitter will still report the float position regardless of the actual process fluid level. This by definition is a Dangerous Undetectable failure. To prevent this failure the float will need to be inspected for integrity and movement. Some transmitters will have two floats mounted on the sensor tube. This inspection should be done on both floats.

1. Move the float up and down the length of the sensor tube. It should move freely from the bottom of the sensor tube to the process connection.
2. Remove the float from the sensor tube by removing the retaining clip or bolt from the end of the transmitter. Inspect the float for signs of excessive wear or damage.
3. Submerge the float in a container of water to check for leaks as air bubbles escaping from the float. The float is a sealed unit and any holes in the shell of the float could allow process fluid to seep inside.

Note: ABB floats are designed for different specific gravity ranges. The float may or may not float in the water. It may be necessary to hold the float under the water to perform this test.

Upon completion of float inspection, place the float back on the sensor tube paying careful attention to float orientation. Some AT100 transmitters will be equipped with float spacers designed to keep the float positioned in the measurable range of the sensor tube. It is important that the spacer be replaced when the transmitter is reassembled.

6.0 SAFETY, MAINTENANCE, AND TROUBLESHOOTING

6.4.2 Sensor Inspection

The sensor of the AT100 consists of a metal tube containing several wires. The sensor tube will measure the float location properly if the tube is straight and the float can travel freely up and down its length. Perform a visual inspection on the sensor tube to make sure it is straight, free from pits or gouges, and does not show excessive wear patterns.

6.4.3 Transmitter Testing

The transmitter of the AT00 is designed to return a level indication and an output based on the position of a float on its sensor tube. If the transmitter is equipped with an LCD the level and output will be displayed on the front of the electronics module.

1. Apply power to the AT100 using the typical power setup for the particular option.
2. Move the float up and down the sensor tube.
3. Monitor the indication of the level on the LCD to make sure the indication corresponds to the float position.
4. Remove the float to make sure the transmitter responds with an Alarm Indication (based on the jumper position) and a level indication of ****.
5. Replace the float.

Note: It is possible for the AT100 to continue providing a 4-20mA output if the LCD display is not functioning properly. If the LCD indicator on an electronics module fails to operate, it is recommended that the electronics module be replaced at the earliest convenience. It will not be necessary however to shut down a transmitter or remove it from service based on an LCD failure.

6.4.4 Output Checkout

The AT100 can be equipped to provide level indication through the 4-20mA output, HART communications, Foundation Fieldbus, or Honeywell DE depending on the model ordered. Only transmitters that are specified to output 4-20mA may be used in a Safety Implemented System. The HART communication capability of the 4-20mA transmitter will only be used for configuration and proof testing.

6.4.4.1 4-20mA Output

The current output of the AT100 transmitter update at least every 110 milliseconds and be filtered through the user adjusted Damping. The maximum response time to a process change will be less than 110 milliseconds or the value of the Damping, whichever is greater.

1. Apply power to the transmitter using the typical loop wiring diagram in Section 8.0.
2. Connect a multi-meter (set to read milliamps) to the transmitter using the "Meter" connections on the terminal strip.
3. Move the float along the length of the probe and monitor the milliamp output on multi-meter .
4. The output should indicate the float position based on the calibration range of the transmitter.

6.4.4.2 HART Output

1. Apply power to the transmitter using the typical loop wiring diagram in Section 8.0.
2. Connect a HART handheld device across a 250 ohm resistor in series with the loop.
3. Move the float along the length of the probe and monitor the PV indication on the handheld device.
4. The output should indicate the float position based on the calibration range of the transmitter.

Note: A HART handheld device will communicate with the AT transmitter as a Generic Device. If the output of the transmitter becomes latched, the HART handheld will respond with a warning that the Process Variable is out of range. To overcome the error, press OK when prompted to "ignore the next 50 occurrences."

6.0 SAFETY, MAINTENANCE, AND TROUBLESHOOTING

6.4.4.3 4-20mA Loop Check

- Without HART

With the transmitter installed, wired and powered in its field location, move the float up and down the length of the probe. Confirm the proper reading at the indication or control side of the loop. Move the float using the process fluid or some other mechanical means. If moving the float is not possible, the loop may be checked using an independent device such as a loop calibrator.

- With HART communications

With the transmitter installed, wired and powered in its field location and power supplied to the loop, connect a HART handheld device to the loop across a 250 ohm resistor. Using the Loop Test feature of the HART handheld, drive the output of the transmitter to 4mA and 20mA. Confirm the proper reading at the indication or control side of the loop.

Minor adjustments to the output of the transmitter may be made using the DAC Trim (Digital/Analog Converter) feature.

6.5 4-20mA, HART Transmitters

Symptom	Possible Problem	Solution
Display showing **** Unit in alarm (20.97 or 3.61 mA)	Threshold voltage too high	Turn the threshold voltage adjustment counter-clockwise 1 full turn or follow the threshold adjustment procedure in Section 6.8
	Electronics module failure	Replace the existing module with a known working module
	Float missing or damaged	Inspect float for presence or damage, if damaged contact the factory for replacement
	Sensor tube failure	Consult the factory for assistance
Output unstable	Threshold voltage too high	Turn the threshold voltage adjustment counter-clockwise 1 full turn or follow the threshold adjustment procedure in Section 6.8
	Threshold voltage too low	Turn the threshold voltage adjustment clockwise 1 full turn or follow the threshold adjustment procedure in Section 6.8
	Rapid level changes	Increase the Damping
	Short span (< 12" (600mm))	Increase the Damping
	Excessive vibration	Consult the factory for assistance
Steady output with changing level	Residual magnetism on probe	Swipe the sensor tube from the top to the bottom with a magnet
	Threshold voltage too low	Turn the threshold voltage adjustment clockwise 1 full turn or follow the threshold adjustment procedure in Section 6.8
	Float not moving	Inspect the float for damage
		Confirm the float is suitable for the process specific gravity
Inspect the sensor tube for buildup on probe		
LCD display not lit	No power to the transmitter	Check the field wiring for proper polarity and supply voltage at the transmitter
	Electronics module failure	Replace the existing module with a known working module
Output does not match display	DAC Trim	Perform the DAC Trim procedure Section 4.8
	Terminal Strip Failure	Check the terminal strip per Section 6.7 and replace if necessary
Cannot change menu settings	Write protect jumper in the ON position	Move the write protect jumper to the upper position and cycle the power
	Electronics module failure	Replace the existing module with a known working module
Transmitter does not communicate via HART	The module is not equipped with HART communications	Check the model number of the transmitter or module to confirm the module type is M3 or higher
	The transmitter is in an alarm condition	Determine and correct the cause of the alarm condition before proceeding further
	There is not enough loop resistance for HART communication	Ensure at least 250 ohms of resistance exists in the loop wiring to best facilitate HART communication
	Electronics module failure	Replace the existing module with a known working module
Incorrect temperature indication	Incorrect temperature calibration	Perform the TMP RSET and recalibrate the temperature sensor if necessary
	RTD failure	Remove the electronics module. Check for resistance between the yellow and red wires of the RTD. Consult the factory if the circuit is open.

6.0 SAFETY, MAINTENANCE, AND TROUBLESHOOTING

6.6 Foundation Fieldbus Transmitters

Foundation Fieldbus transmitters operate using the same level measurement techniques as 4-20mA transmitters. This troubleshooting section only covers problems specific to Foundation Fieldbus setup and communications. Troubleshooting of the level indication from the Transducer Block may require the use of the 4-20mA, HART troubleshooting section.

Symptom	Possible Problem	Solution
Current output does not change with level change	Per the Foundation Fieldbus standard, each instrument must have a quiescent current draw. The quiescent current draw of an AT100 transmitter is 12.5mA. There is not a problem with the transmitter.	
LCD does not match AI Block output	The information displayed on the LCD is supplied by the Transducer Block. This information will be mapped through the AI Block for use in the network. There is not a problem with the transmitter.	
Unable to load a configuration to the transmitter	DD Files not in the host system	DD Files for the AT100 transmitter are available for download at www.fieldbus.org . DD Files must be installed for proper transmitter operation within the network.
Transmitter does not communicate through FF	Terminal Strip Failure	Follow the procedure in Section 6.7 to verify terminal strip failure. If the terminal strip is faulty, contact the factory for replacement parts and procedures.
AI Block output does not correspond to level change	Transmitter in Simulate Mode	Move the Simulate Mode jumper (front of the module) to the upper position and cycle the power Set the value of SIMULATE (AI Block) to "Disable"
	Faulty AI Block configuration	Review the AI Block configuration to confirm the required output will be generated
BLOCK_ERR Block Configuration Error	XD_SCALE does not have a suitable engineering unit	Ensure the engineering unit used in the XD_SCALE is a valid linear measurement unit
	XD_SCALE does not contain a valid range	The range of the XD_SCALE cannot exceed the SENSOR_RANGE. If it is required to have the XD_SCALE exceed the SENSOR_RANGE, the values of the scaling can be adjusted to correspond to the SENSOR_RANGE and the excess will be extrapolated on each end of the range.
	L_TYPE is invalid	Review the AI Block configuration to confirm the required output will be generated. To use XD_SCALE the L_TYPE must be set to INDIRECT
	Out of Service	Ensure the MODE_BLK is set to AUTO

6.0 SAFETY, MAINTENANCE, AND TROUBLESHOOTING

During normal operation, it is not necessary to perform maintenance on the AT100 transmitter. Routine calibration of the transmitter is not necessary. The AT100 contains an EPROM which will store calibration in case of an outage or electronics replacement.

6.7 Verify Proper Power-up of the Transmitter

Use a mA meter to measure the output current. When power is applied, the output should go to 4.00 mA for at least 1 second, and then to either the measured level or an alarm condition output. If this does not happen, the transmitter may not be receiving enough power, or the main electronic is defective. Excessive current above 21 mA is also an indication of improper power-up or defective electronics.

- Valid Current Loop Outputs:

- **20.99 mA** - High Alarm (The LCD Display will indicate level as ****)

If the top board jumper is set to HIGH ALARM, a loss of signal or a problem with the configuration or a malfunction, will cause the output to be set to the alarm condition of 20.99 mA.

- **20.58 mA** - Latched High

When the level increases above the 20 mA point, the output will continue up to 20.58 mA and then latch at this value, until the level comes back down again.

- **4.00 - 20.00mA**. - Normal output range

- **3.85 mA** - Latched Low

When the level decreases below the 4 mA point, the output will continue down to 3.85 mA and then latch at this value, until the level comes back up again.

- **3.61 mA** - Low Alarm (The LCD Display will indicate level as ****)

If the top board jumper is set to LOW ALARM, a loss of signal or a problem with the configuration or a malfunction, will cause the output to be set to the alarm condition of 3.61 mA

6.8 Verify Current Output Stability

If the output occasionally jumps up or down but not to an alarm condition, use a hand held P/S or hand held loop calibrator to isolate the transmitter from the field wiring. If the problem disappears, this can be an indication of noise or grounding problem. Field wiring should be run with an individually shielded cable with the shield connected to ground at the power source and floating at the transmitter housing. Insure that the transmitter housing is effectively connected to earth ground.

If the problem persists, there may be a location on the tube that has retained some magnetization, and needs to be cleared. This can occur when a magnetized object such as a tool has been brought close to the sensor. To clear any residual magnetization, slide a magnet or float against and parallel to the tube, from one end to the other.

6.0 SAFETY, MAINTENANCE, AND TROUBLESHOOTING

6.9 Threshold Adjustment

If the output occasionally jumps to an alarm condition (**** on display), this can be an indication of a loss of signal or a transmitter threshold voltage not set properly. The adjustment can be done as follows

Note: It is preferable to make this adjustment with the float located towards the end of the sensing tube, away from the transmitter housing, but within the normal measuring range. This is the only adjustment that can be done on the unit.

- Locate adjustment potentiometer next to the bottom right of the electronics module.
- With unit powered up, turn adjustment CLOCKWISE until the output goes and stays in alarm (3.6mA or 21 mA).
- Turn adjustment slowly COUNTER-CLOCKWISE until a steady output is established. This output should match the float position.
- Turn adjustment slowly COUNTER-CLOCKWISE and keep track of the number of turns, until the output is not stable any more.
- Turn adjustment back CLOCKWISE, half the amount of turns recorded in previous steps. Verify that a steady output is achieved.

Proper orientation of the electronics module.

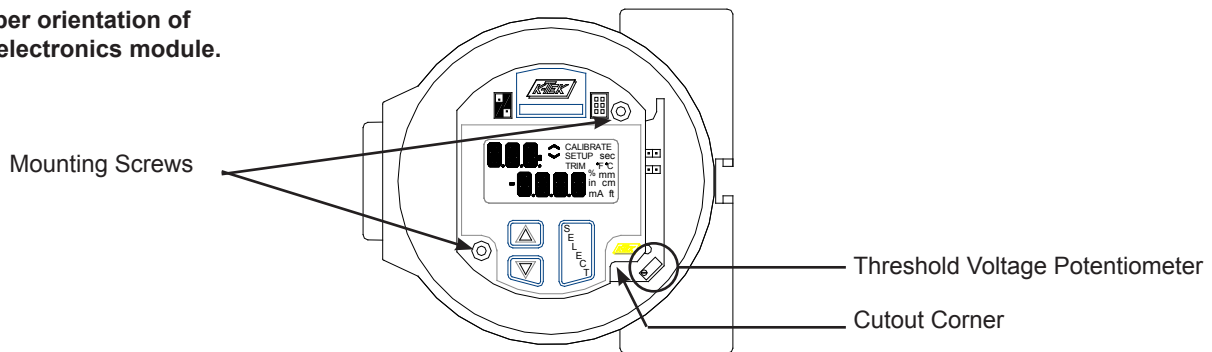

6.10 Module Replacement

The AT100 transmitter is equipped with modular electronics which may be removed from the housing. An EPROM and a threshold adjustment potentiometer located in the transmitter housing will maintain the settings of the transmitter if the electronics are removed. This allows the replacement of failed electronic modules and upgrading of electronics or transmitter software without losing calibration and setup configuration.

Before removing the electronics module for replacement or upgrade, the AT100 transmitter should be taken out of service. To remove the electronics module, simply loosen the 2 mounting screws, unplugging the module from the housing and replace it with the new module.

The software revision of a transmitter can be identified by a tag on the back of the electronics module. The date code of the software revision will appear as a series of numbers such as AT_H_090209 or AT_H_TS_090209. The type of module will be identified on the same tag with a code such as M4AS or M4BS.

CAUTION **WARNING:** In order to maintain certification requirements, repair of the instrument at the electronic component level can only be performed at the factory. Field repair of electronics components should only involve replacing electronic modules. Opening the electronics module will void all warranties of the transmitter.

6.11 Terminal Strip Checkout

Moisture within the housing may cause failure of the RFI filtering within the terminal strip. This can be indicated as a current output that is higher than the current indicated by the LCD Display. To verify terminal strip failure, remove the field wiring and the electronics module. Using a multi-meter, check the resistance from each of the terminal points to the housing. All of the terminal positions should indicate open to the housing. Consult the factory for terminal strip servicing procedures.

6.0 SAFETY, MAINTENANCE, AND TROUBLESHOOTING

6.12 Threshold Adjustment Using an Oscilloscope

Principle of Operation:

The main module in the AT housing performs 10 measurement cycles per second.

1. Start of cycle: A current pulse (Start Pulse) is applied to the sensor wire, which is under tension in the sensor tube. This current produces a magnetic field along the sensor wire.
2. The interaction of the sensor wire magnetic field, and the magnetic field at the float, causes a small twist in the wire at the point where the float is located.
3. The small twist is like an ultrasonic vibration, which propagates along the sensor wire from the float position, up the wire, towards a piezo-ceramic sensor located at the top of the tube.
4. The piezo-ceramic sensor is located at the top of the tube.
5. The AT electronics' measures the time between the Start Pulse (of Step 1) and the Return Pulse (of step 4). The measured time changes with the position of the float, and the level output is calculated from that. Note: To detect the return pulse, the AT module looks for a signal amplitude exceeding a certain threshold voltage which is set by the variable potentiometer on the bottom board of the AT. (See drawing below.)
6. The threshold voltage should be set for one half of the return signal strength.

Using a scope meter to assess transmitter operation:

Note: Before using an oscilloscope on an AT transmitter, confirm the electrical classification of the working area and take all necessary precautions for safe operation and connection to the instrument.

Settings using a Fluke Oscilloscope 97 (50 MHz) or any other two channel scope (Min Bandwidth 10 MHz)

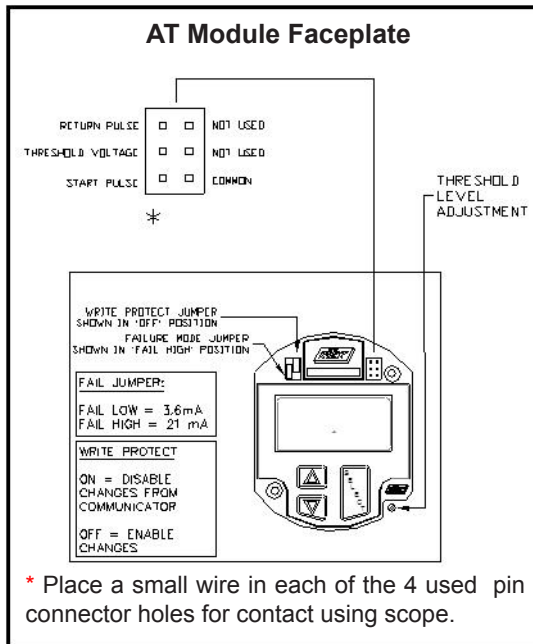

Channel A: Refer to the drawing at left for probe connections.

- Connect probe tip to the Return Pulse (Move probe tip to the pin below it to measure the threshold voltage)
- Set range to 500 mV DC

Channel B:

- Connect probe to the Start Pulse
- Connect the probe ground to the common *
- Set range to 2VAC / Division

Timing and Trigger:

- Set the time to 50, 100, 200uSec/Division (Note: The lower the float is, the farther the return signal is from the start pulse. On units longer than 10 ft., the time base will need to be set to 200uSec/Div or the delay function and increment ahead should be used.)
- Set the trigger to Channel B, Level between -0.5 to -3.0 volts
- Set trigger to negative pulse, mode to normal

NOTE: The diagram to the right is what should be observed using a dual channel oscilloscope. If the float were upside down, the Return Pulse would be inverted. If noise is present, it would show up on the baseline.

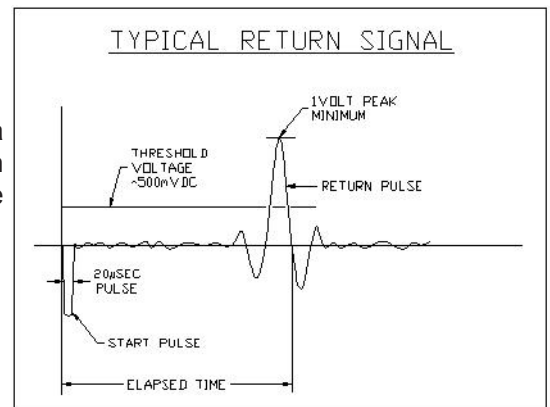

- All AT200 floats have a correct orientation in the chamber.
- Floats are scribed >>>>UP>>>>
- Some AT100 Floats have an orientation.
(Refer to factory for assistance.)





7.0 NAMETAG INFORMATION

ABB	MADE IN USA
MODEL NO:	
SERIAL / TAG NO:	
MAX TEMP - HOUSING: 170°F ; SENSOR:	
WORKING / MAX PRESSURE:	
CAUTION: OPEN CIRCUIT BEFORE REMOVING COVER ATTENTION: OUVRIER LE CIRCUIT AVANT D'ENLEVER LE COUVERCLE	
-HAZARDOUS LOCATIONS: CL I, DIV1, GRPS A,B,C,D CL II, DIV1, GRPS E,F,G, CL III	
	
-INTRINSICALLY SAFE Exib: CL I, DIV1, GRPS A,B,C,D, WHEN INSTALLED PER CONTROL DRAWING ELE0001	
T4: AT 77 C AMBIENT -NEMA 4X	
	T3C -TYPE 4X

FM and CSA Approved
Hazardous Locations and
Intrinsically Safe

ABB	MADE IN USA
MODEL NO:	
SERIAL / TAG NO:	
MAX TEMP - HOUSING: 170°F ; SENSOR:	
WORKING / MAX PRESSURE:	
CAUTION: OPEN CIRCUIT BEFORE REMOVING COVER ATTENTION: OUVRIER LE CIRCUIT AVANT D'ENLEVER LE COUVERCLE	
-HAZARDOUS LOCATIONS: CL I, DIV1, GRPS A,B,C,D CL II, DIV1, GRPS E,F,G, CL III	
	
-INTRINSICALLY SAFE Exib: CL I, DIV1, GRPS A,B,C,D, WHEN INSTALLED PER CONTROL DRAWING ELE0001	
T4: AT 77 C AMBIENT -NEMA 4X	
	T3C -TYPE 4X



FM and CSA Approved
Intrinsically Safe Only
F1 and SW3 options

ABB	MADE IN USA
MODEL NO:	
SERIAL / TAG NO:	
MAX TEMP - HOUSING: 170°F ; SENSOR:	
WORKING / MAX PRESSURE:	
CAUTION: OPEN CIRCUIT BEFORE REMOVING COVER ATTENTION: OUVRIER LE CIRCUIT AVANT D'ENLEVER LE COUVERCLE	
-HAZARDOUS LOCATIONS: CL I, DIV1, GRPS A,B,C,D CL II, DIV1, GRPS E,F,G, CL III	
	
-INTRINSICALLY SAFE Exib: CL I, DIV1, GRPS A,B,C,D, WHEN INSTALLED PER CONTROL DRAWING ELE0001	
T4: AT 77 C AMBIENT	
	T3C

FM and CSA Approved
Hazardous Locations only
RI, M4AD, M4BD, M5AD, M5BD
options

ABB	MADE IN USA
MODEL NO:	
SERIAL / TAG NO:	
MAX TEMP - HOUSING: 170°F ; SENSOR:	
WORKING / MAX PRESSURE:	
CAUTION: OPEN CIRCUIT BEFORE REMOVING COVER ATTENTION: OUVRIER LE CIRCUIT AVANT D'ENLEVER LE COUVERCLE	
-HAZARDOUS LOCATIONS: CL I, DIV1, GRPS A,B,C,D CL II, DIV1, GRPS E,F,G, CL III	
	
-INTRINSICALLY SAFE Exib: CL I, DIV1, GRPS A,B,C,D CL II, DIV1, GRPS E,F,G, CL III & SUITABLE (FMRC NON-INCENDIVE) CL I, DIV2, GRPS A,B,C,D, WHEN INSTALLED PER CONTROL DRAWING ELE1036	
T4 AT 77 C AMBIENT -NEMA 4X	
	FISCO FIELD DEVICE



FM Approved
Foundation Fieldbus option

ABB	LOUISIANA, 70789	MADE IN USA
MODEL NO:		
SERIAL / TAG NO:		
MAX AMB. TEMP - HOUSING: -20 TO +66°C; SENSOR:		
SENSOR MAX PRESSURE: VMAX:36VDC, PMAX:1W		
CAUTION: OPEN CIRCUIT BEFORE REMOVING COVER ATTENTION: OUVRIER LE CIRCUIT AVANT D'ENLEVER LE COUVERCLE		
		II 1/2 G D EEx ia IIB T6 T80°C (D) 02ATEX132658
0539 INTRINSICALLY SAFE: ZONE 0,1 AND 2, U _i ≤ 36 VDC Ci = 15 nF Pi ≤ 1 W		
0036 PED I _i ≤ 200 mA L _i ≤ 10 uH		
IP67		TAG0007



ATEX Approved
Intrinsically Safe
excludes RI option

ABB	LOUISIANA, 70789	Сделано в США
TAG0139		
МОДЕЛЬ:		
СЕРИЙНЫЙ НОМЕР:		
Темп. среды: -40...+66°C; Т-сенсор:		
МАКС. ДАВЛЕНИЕ: мПа У макс.= 30 В		
ВНИМАНИЕ: ОТКРЫВАТЬ, ОТКЛЮЧИВ ОТ СЕТИ!		
НАИМ О ЦЕБЗ № РОСС Г.С. F505.В01295		
	1Exd IIC T6	IP67
0Exial IIB T6 ИСПОБЕСОПАСНАЯ ЦЕПЬ: U _i = 30 В Ci = 11 нФ Pi = 1 Вт I _i = 200 мА L _i = 10 мкГн		

GOST Russia Approved
Hazardous Locations and
Intrinsically Safe

ABB	LOUISIANA, 70789	MADE IN USA
MODEL NO:		
SERIAL / TAG NO:		
MAX AMB. TEMP - HOUSING: -20 TO +66°C; SENSOR:		
SENSOR MAX PRESSURE: VMAX:36VDC		
CAUTION: OPEN CIRCUIT BEFORE REMOVING COVER ATTENTION: OUVRIER LE CIRCUIT AVANT D'ENLEVER LE COUVERCLE		
		II 1/2 G D EEx d IIC T6 T80°C (D) 02ATEX132658
0539 FLAMEPROOF ZONE 1 AND 2		
0036 PED		
IP67		TAG0006

ATEX Approved
Flameproof
Excludes F1 and SW3 options

ABB	18321 SWAMP ROAD PRAIRIEVILLE, LA 70789	MADE IN USA
MODEL NO:		
SERIAL / TAG NO:		
MAX AMB. TEMP - HOUSING: -20 TO +66°C; SENSOR:		
SENSOR MAX PRESSURE: VMAX:30VDC		
CAUTION: OPEN CIRCUIT BEFORE REMOVING COVER ATTENTION: OUVRIER LE CIRCUIT AVANT D'ENLEVER LE COUVERCLE		
		II 1/2 G D EEx ia IIB T4 T66°C
0036 PED INTRINSICALLY SAFE: ZONE 0,1 AND 2, U _i ≤ 30 VDC Ci = 15 nF Pi = 1 W		
I _i ≤ 200 mA L _i ≤ 10 uH		
IP67		TAG0082

IEC Approved
Intrinsically Safe
excludes RI option

ABB	LOUISIANA, 70789	MADE IN USA
MODEL NO:		
SERIAL / TAG NO:		
MAX AMB. TEMP - HOUSING: -20 TO +66°C; SENSOR:		
SENSOR MAX PRESSURE:		
CAUTION: OPEN CIRCUIT BEFORE REMOVING COVER ATTENTION: OUVRIER LE CIRCUIT AVANT D'ENLEVER LE COUVERCLE		
		II 1/2 G D EEx ia IIB T4 T80°C (D) 02ATEX132658
0539 I.S.: ZONE 0,1 AND 2, U _i = 28 VDC Ci = 4.5 nF		
0036 PED Pi = 1.2 W I _i = 250 mA L _i = 10 uH		
FISCO Field Device: U _i = 17.5 VDC Ci = 4.5 nF		
Pi = 5.32W I _i = 380 mA L _i = 10 uH		
IP67		TAG0090

ATEX Approved
Intrinsically Safe
Foundation Fieldbus option

8.0 WIRING DIAGRAMS

8.1 FM/CSA

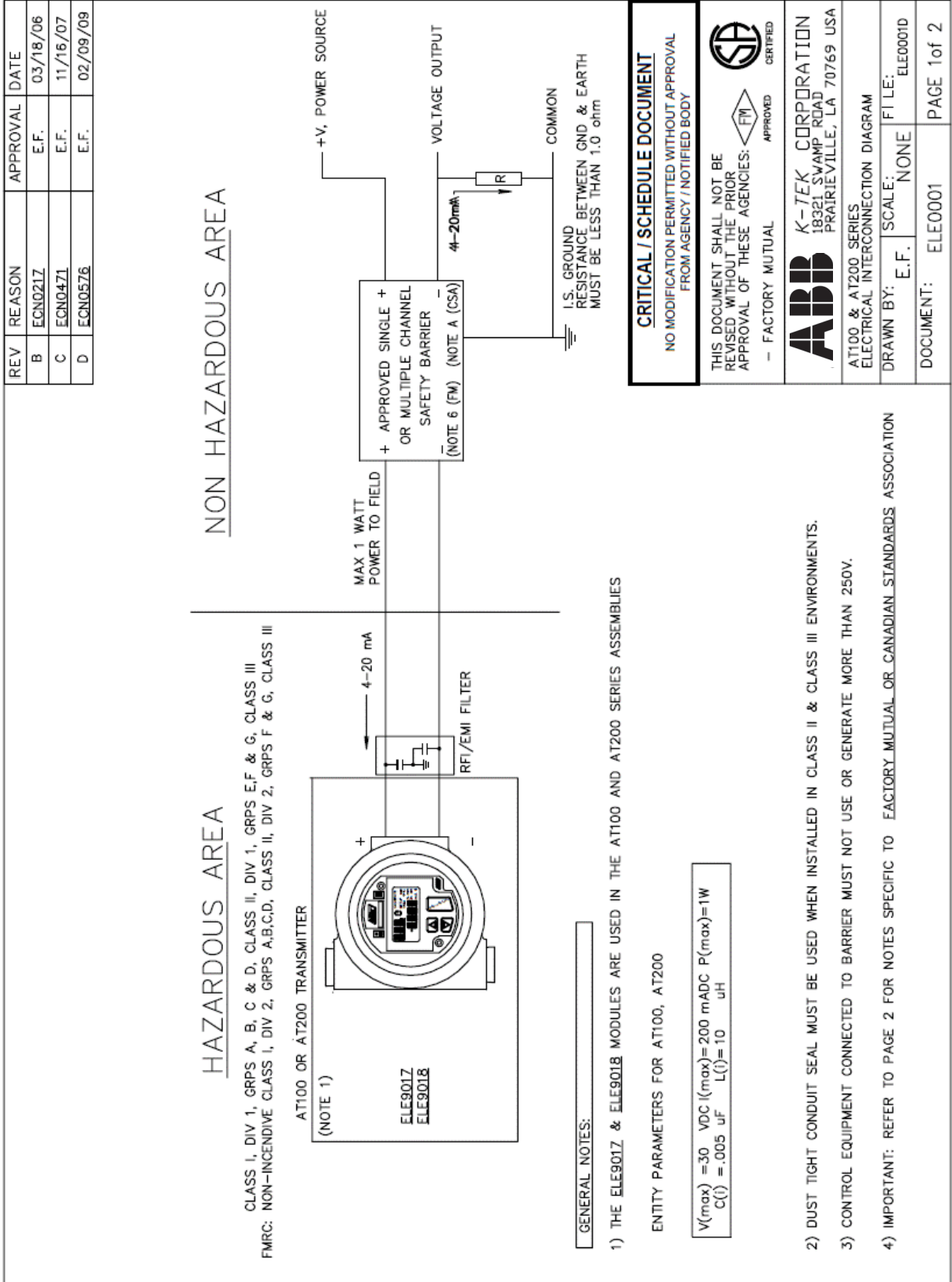

8.0 WIRING DIAGRAMS

8.1 FM/CSA (continued)

REV	REASON	APPROVAL	DATE
B	ECN021Z	E.F.	03/18/06
C	ECN047L	E.F.	11/16/07
D	ECN0576	E.F.	02/09/09

NOTES RELATED TO FM APPROVAL:

5) THE ELE901Z & ELE901B MODULES CONFORMS TO FMRC APPROVAL STANDARD NO.3610.

6) SAFETY BARRIER MUST MEET THE FOLLOWING REQUIREMENTS:
 $V(oc) \text{ or } V(t) \leq V(max)$, $I(sc) \text{ or } I(t) \leq I(max)$, $C(a) > (C(i) + C(cable))$, $L(a) > (L(i) + L(cable))$

7) FOR DIV 2 APPLICATIONS, THE TRANSMITTER MUST EITHER BE INSTALLED IN ACCORDANCE WITH NATIONAL ELECTRICAL CODE FOR DIVISION 2 WIRING METHODS OR CONNECT TO AN FMRC APPROVED BARRIER.

8) ASSOCIATED EQUIPMENT MUST BE FMRC APPROVED.

9) NONINCENDIVE FIELD WIRE PARAMETERS:
 ENTITY PARAMETERS FOR AT100, AT200
 $V(max) = 30 \text{ VDC}$, $I(max) = 90 \text{ mADC}$, $P(max) = 1W$
 $C(i) = .005 \text{ uF}$, $L(i) = 10 \text{ uH}$

10) INSTALLATION SHALL BE IN ACCORDANCE WITH ANSI/ISA RP12.6 AND THE NEC ANSI/NFPA 70.

11) SYSTEM CALCULATIONS: ADD CABLE CAPACITANCE & INDUCTANCE TO TRANSMITTER ENTITY PARAMETERS (I.E. ALL FIELD INSTALLED CAPACITANCE & INDUCTANCE MUST BE CONSIDERED).
 IF CABLE PARAMETERS ARE NOT KNOWN, 60pF/ft & 0.2uH/ft SHOULD BE USED.

NOTES RELATED TO CSA CERTIFICATION:

A) SAFETY BARRIER MUST MEET THE FOLLOWING REQUIREMENTS:
 $V(oc) \leq V(max)$, $I(sc) \leq I(max)$, $C(g) > (C(i) + C(cable))$, $L(a) > (L(i) + L(cable))$
 ONE CERTIFIED DUAL CHANNEL OR TWO SINGLE CHANNEL BARRIERS MAY BE USED WHERE BOTH CHANNELS HAVE BEEN CERTIFIED FOR USE TOGETHER WITH COMBINED ENTITY.

B) FOR DIV 2 APPLICATIONS, THE TRANSMITTER MUST BE INSTALLED IN ACCORDANCE WITH CANADIAN ELECTRICAL CODE PART 1 (C22.1) FOR DIVISION 2 WIRING METHODS.

C) ASSOCIATED EQUIPMENT MUST BE CSA CERTIFIED.

D) INSTALLATION SHALL CONFORM TO THE INSTRUCTIONS SUPPLIED WITH SAFETY BARRIERS, AND TO THE C.E.C. PART I.

E) ADDITIONAL NOMENCLATURE: Exig – INTRINSICALLY SAFE – SECURITE INTRINSEQUE

F) WARNING: SUBSTITUTION OF COMPONENTS MAY IMPAIR SUITABILITY FOR USE IN HAZARDOUS LOCATIONS.
 AVERTISSEMENT: LA SUBSTITUTION DE COMPOSANTS PEUT RENDRE CE MATERIEL INACCEPTABLE POUR LES EMPACEMENTS DANGEREUX.

G) WARNING: EXPLOSION HAZARD – DO NOT DISCONNECT EQUIPMENT UNLESS POWER HAS BEEN SWITCHED OFF OR THE AREA IS KNOWN TO BE NON-HAZARDOUS.
 AVERTISSEMENT: RISQUE D'EXPLOSION – AVANT DE DISCONNECTER L'EQUIPEMENT, COUPER LE COURANT OU S'ASSURER QUE L'EMPACEMENT EST DESIGNÉ NON DANGEREUX.

CRITICAL / SCHEDULE DOCUMENT
 NO MODIFICATION PERMITTED WITHOUT APPROVAL FROM AGENCY / NOTIFIED BODY



THIS DOCUMENT SHALL NOT BE REVISED WITHOUT THE PRIOR APPROVAL OF THESE AGENCIES:
 – FACTORY MUTUAL



ABB K-TEK CORPORATION
 18321 SWAMP ROAD
 PRAIRIEVILLE, LA 70769 USA

AT100 & AT200 SERIES
 ELECTRICAL INTERCONNECTION DIAGRAM

DRAWN BY: E.F. SCALE: NONE FILE: ELE0001D

DOCUMENT: ELE0001 PAGE 2 of 2

8.0 WIRING DIAGRAMS

8.2 ATEX/IEC

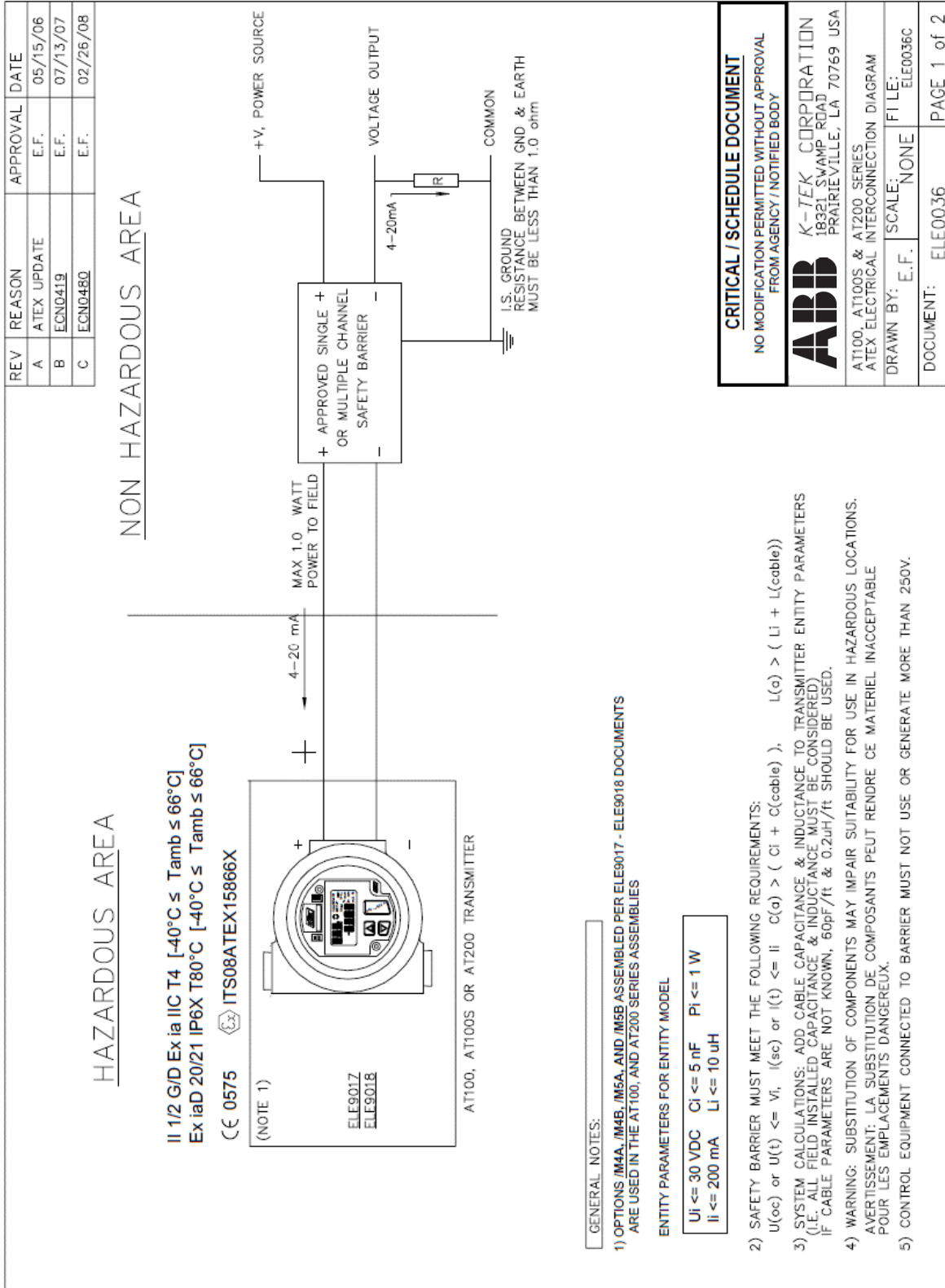

8.0 WIRING DIAGRAMS

8.2 ATEX/IEC (continued)

REV	REASON	APPROVAL	DATE
A	ATEX UPDATE	E.F.	05/15/06
B	ECN0419	E.F.	07/13/07
C	ECN0480	E.F.	02/26/08

6) THE MODULES M4AF, M4BF, M5AF, AND M5BF ASSEMBLED PER ELE9017 & ELE9018 DOCUMENTS ARE USED IN THE AT100, AND AT200 SERIES ASSEMBLIES

ENTITY PARAMETERS FOR ENTITY MODEL:

$V(max)$	= 28 VDC	$I(max)$	= 250 mADC	$P(max)$	= 1.2W
$C(i)$	= 4500 pF	$L(i)$	= 10 uH		

HAZARDOUS AREA

II 1/2 G/D Ex ia IIC T4 [-40°C ≤ Tamb ≤ 66°C]
Ex iaD 20/21 IP6X T80°C [-40°C ≤ Tamb ≤ 66°C]

Additionally the Models AT100, AT100S and AT200 has been examined and found to comply with the additional requirements of EN/IEC 60079-27: 2008 for FISCO Field Device Ex ia IIC T4

€ 0575  ITS08ATEX15866X

NON HAZARDOUS AREA

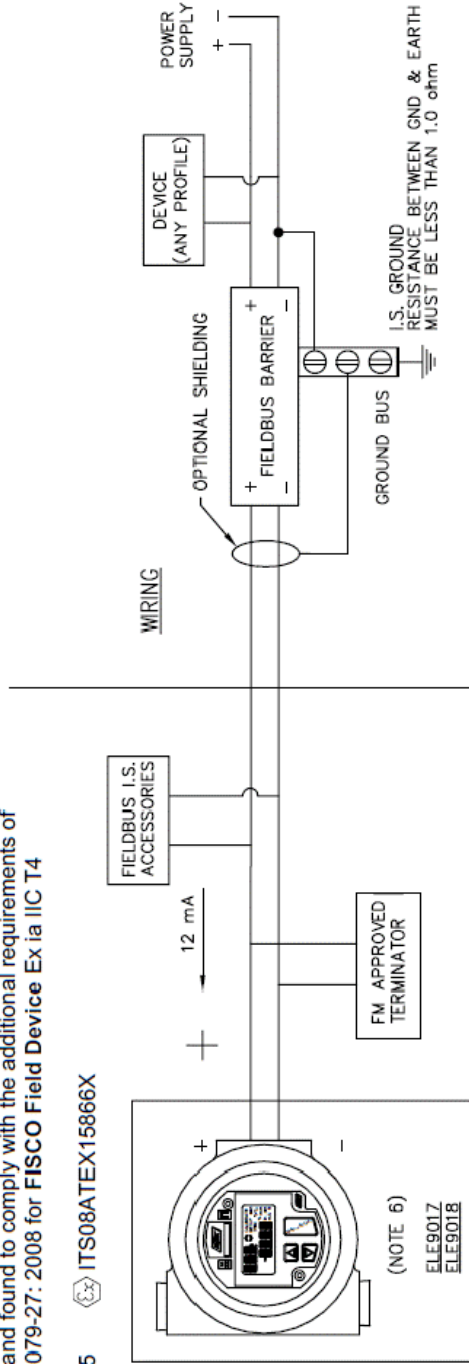

AT100 OR AT200 TRANSMITTER

CRITICAL / SCHEDULE DOCUMENT

NO MODIFICATION PERMITTED WITHOUT APPROVAL FROM AGENCY / NOTIFIED BODY



K-TEK CORPORATION
18321 SWAMP ROAD
PRAIRIEVILLE, LA 70769 USA

AT100, AT100S & AT200 SERIES
ATEX ELECTRICAL INTERCONNECTION DIAGRAM

DRAWN BY: E.F. SCALE: NONE FILE: ELE0036C

DOCUMENT: ELE0036 PAGE 2 of 2

8.0 WIRING DIAGRAMS

8.3 Typical Loop Wiring Diagram

REV	REASON	APPROVAL	DATE
N.C.	FIRST RELEASE	E.F.	11-20-97
A	ADD HOOKUP	E.F.	8-04-98
B	ADD MT2000	E.F.	04-07-00

CRITICAL DOCUMENT
 NO CHANGE WITHOUT PRIOR
 CERTIFICATION AGENCY APPROVAL



ABB K-TEK CORPORATION
 18321 SWAMP ROAD
 PRAIRIEVILLE, LA 70769 USA

LOOP POWERED TX HOOKUP
 DUAL COMPARTMENT HOUSING

DRAWN BY: E.F. FILE: NONE
 SCALE: NONE ACORN: ELE1002A

DOCUMENT: ELE1002 | PAGE 1 OF 1

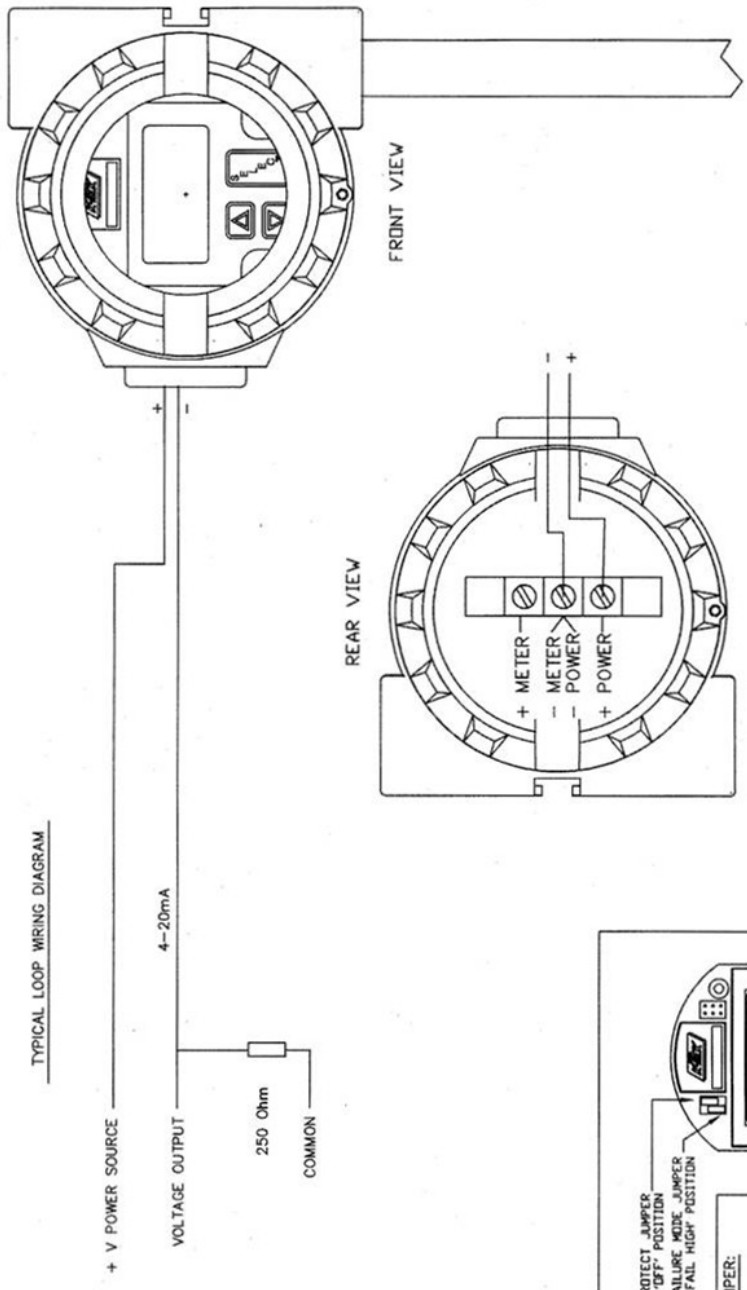
NOTE: THIS DRAWING APPLICABLE TO:
 AT100, AT100S, AT100P
 AT200, AT200P, MT2000 SERIES

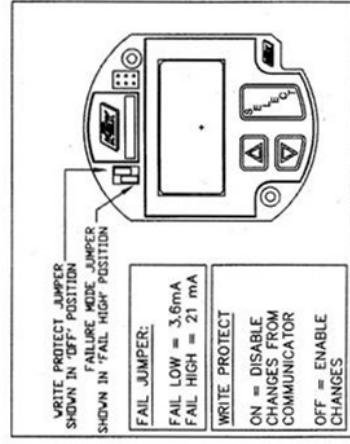

8.0 WIRING DIAGRAMS

8.4 Loop Powered TX Hookup /RI Dual Compartment Housing



ABB K-TEK LLC
18321 SWAMP ROAD
PRAIRIEVILLE, LA 70769 USA

LOOP POWERED TX HOOKUP /RI
DUAL COMPARTMENT HOUSING

DRAWN BY: KEJ SCALE: NONE FILE: ELE1004E
DOCUMENT: ELE1004 PAGE 1 OF 1

8.0 WIRING DIAGRAMS

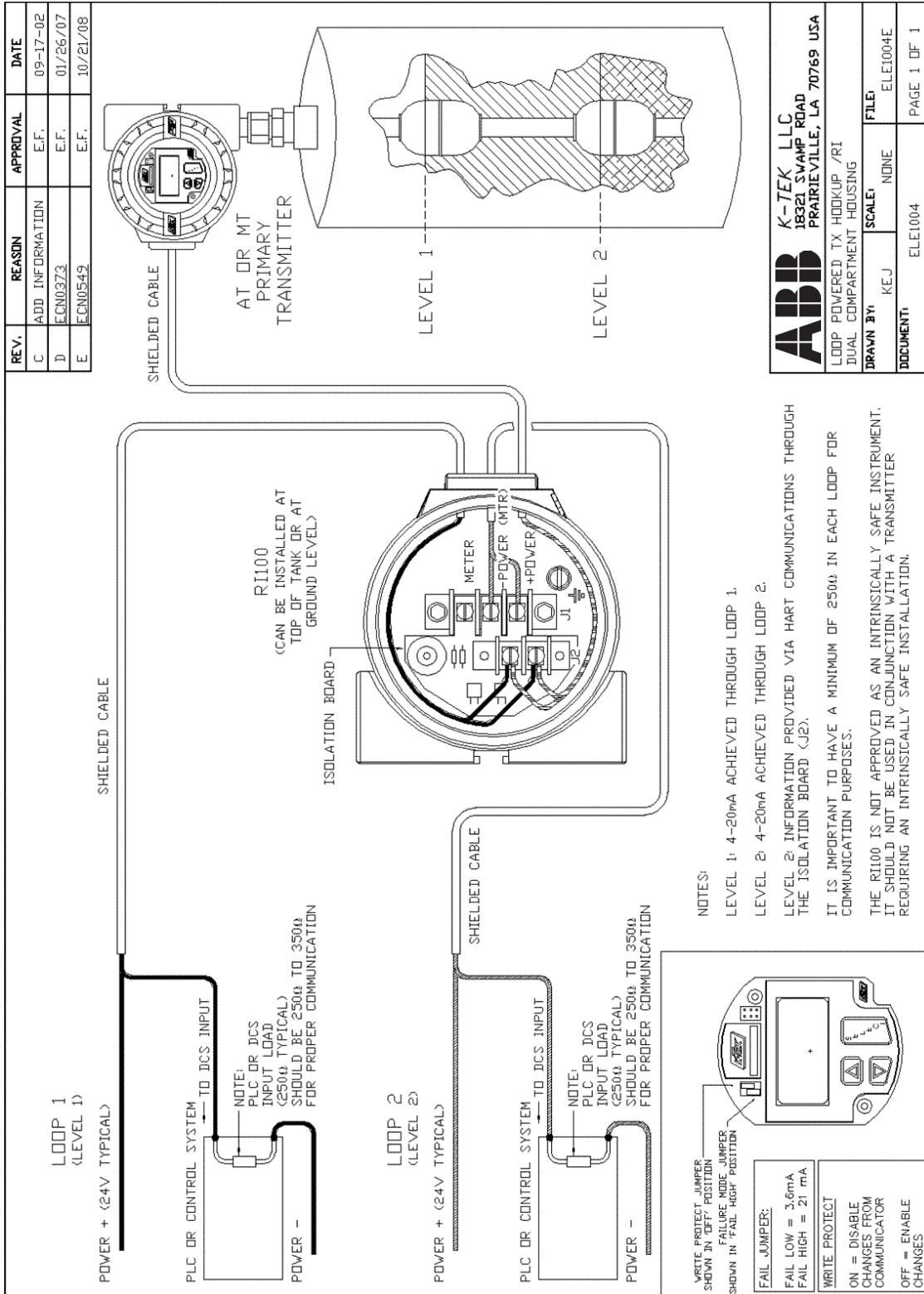
8.5 Temperature Simulation Wiring Diagram

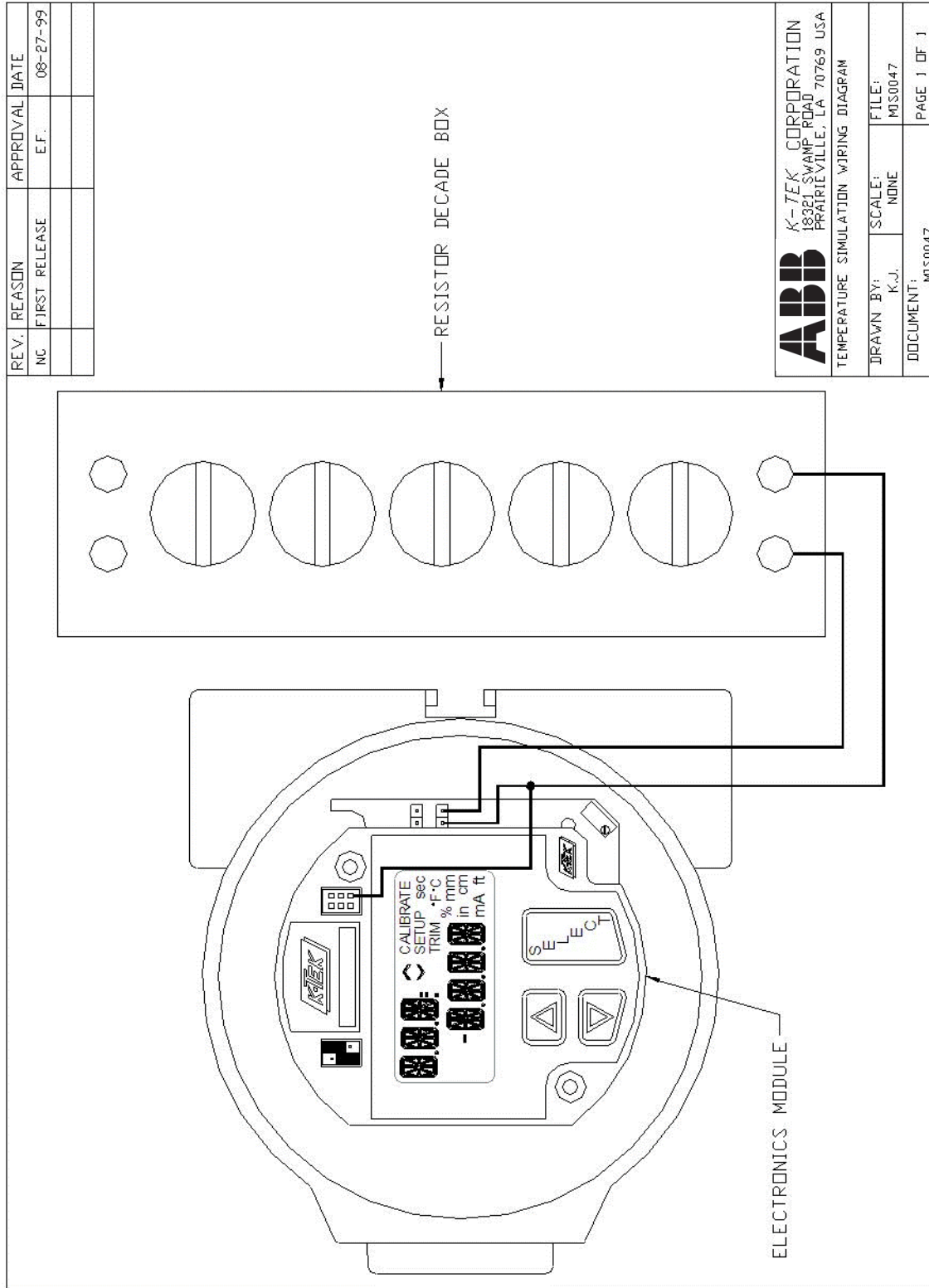

9.0 /F1 OPTION ASSEMBLY DRAWING

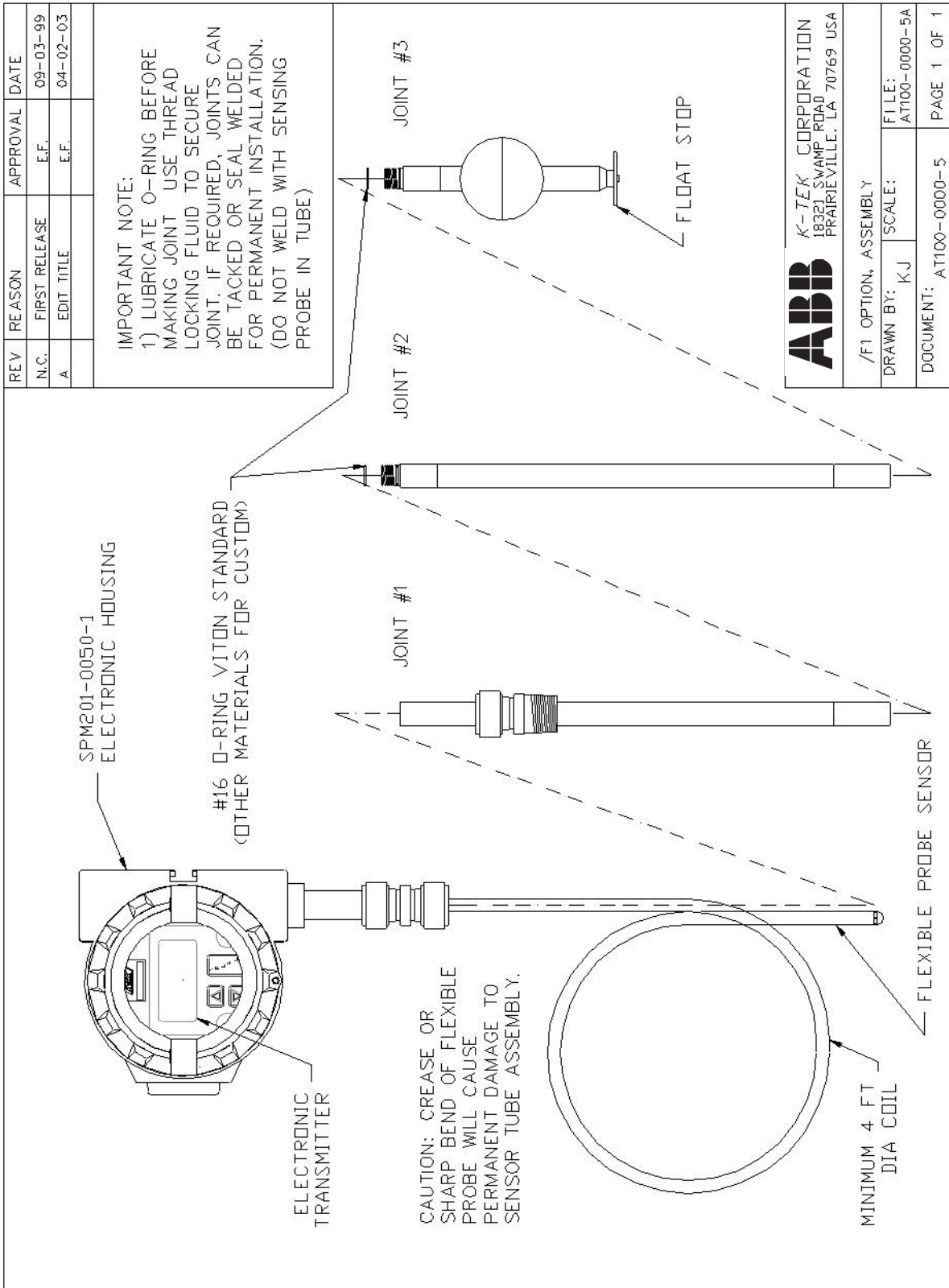

REV	REASON	APPROVAL	DATE
N.C.	FIRST RELEASE	E.F.	09-03-99
A	EDIT TITLE	E.F.	04-02-03

ABB K-TEK CORPORATION
 18321 SWAMP ROAD
 PRAIRIEVILLE, LA 70769 USA

/F1 OPTION, ASSEMBLY
 DRAWN BY: KJ SCALE:
 FILE: AT100-0000-5A
 DOCUMENT: AT100-0000-5 PAGE 1 OF 1

10.0 SIL Certificate

The manufacturer
may use the mark:



Reports:

KTEK 08-03-49 R001 V1R0
IEC 61508 Assessment
AT100 100s 200

Validity:

This assessment is valid for
the AT100, AT100S, and
AT200 Magnetostrictive
Level Transmitter.

This assessment is valid until
July 1, 2011.

Revision 1.0 May 30, 2008

Certificate / Certificat

Zertifikat / 認証

KTEK 080349 C001

exida hereby confirms that the:

AT100, AT100s, AT200

Magnetostrictive Level Transmitter

**K-TEK Corporation
Prairieville, LA
USA**

Has been assessed per the relevant requirements of:

IEC 61508 Parts 1, 2, 3

and meets requirements providing a level of integrity to:

Systematic Integrity: SIL 3 Capable

**Random Integrity: SIL 2 @ HFT=0,
SIL 3 @ HFT=1.**

Safety Function:

The AT100, AT100s, and AT200 Magnetostrictive Level Transmitter uses a probe with float to detect a fluid level in a vessel. It subsequently communicates this level to a logic solver.

Application Restrictions:

The unit must be properly designed into a Safety Instrumented Function per the Safety Manual requirements, only the 4-20mA output is certified for use in functional safety applications.

exida
Certification S A



Product Assessor

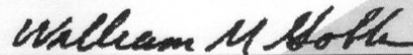

Auditor

10.0 SIL Certificate (continued)

AT100, AT100S, and
AT200
Magnetostrictive
Level Transmitter
K-TEK Corporation
Prairieville, LA USA

Certification S.A.

Form	Version	Date
C61508	2.00	May 2008

Certificate / Certificat / Zertifikat / 認証

KTEK 080349 C001

Systematic Integrity: SIL 3 Capable

Random Integrity: SIL 2 @HFT=0,

SIL 3 @ HFT=1

SIL 3 Capability:

The product has met manufacturer design process requirements of Safety Integrity Level (SIL) 3. These are intended to achieve sufficient integrity against systematic errors of design by the manufacturer.

A Safety Instrumented Function (SIF) designed with this product must not be used at a SIL level higher than the stated without "prior use" justification by end user or diverse technology redundancy in the design.

IEC 61508 Failure Rates

Device	λ_{SD}	λ_{SU}	λ_{DD}	λ_{DU}	SFF
AT100, AT100S, AT200	0 FIT	99 FIT	377 FIT	45 FIT	91.3%

SIL Verification:

The Safety Integrity Level (SIL) of an entire Safety Instrumented Function (SIF) must be verified via a calculation of $PF_{D_{avg}}$ considering redundant architectures, proof test interval, proof test effectiveness, any automatic diagnostics, average repair time and the specific failure rates of all products included in the SIF. Each subsystem must be checked to assure compliance with minimum hardware fault tolerance (HFT) requirements.

* FIT = 1 failure / 10^9 hours

Page 2 of 2

11.0 EU DECLARATION OF CONFORMITY

EU DECLARATION OF CONFORMITY

The EU Directives covered by this Declaration:

89/336/EEC Electromagnetic Compatibility Directive, amended by 92/31/EEC & 93/68/EEC
Pressure Equipment Directive (PED) 97/23/EC
Equipment or Protective System intended for use in Potentially Explosive Atmospheres Directive 94/9/EC

The Products Covered by this Declaration:

AT100, AT100S and AT200 Series 2 Wire Loop Powered Level Transmitters with /CEI or /CEX option

The Basis on which Conformity is being declared:

The product identified above complies with the requirements of the above EU Directives by meeting the following standards:

EN50081-2 Radiated and Conducted Emission
EN50082-2 Radiated and Conducted Immunity

EN61000-4 Electro Magnetic Immunity
EN287/288 Welding

EN50014, EN50284, EN50281-1-1
/CEI option: EN50020
/CEX option: EN50018

The technical documentation required to demonstrate that the product meets the requirements of the Low Voltage Directive has been compiled by the signatory below and is available for inspection by the relevant enforcement authorities. The CE mark was first applied in 1999.

The products described above comply with the essential requirements of the directives specified.

Signed: Eric P. Fausseau

Authority: Vice President Research & Development

Date: January 8, 2010

ATTENTION!

The attention of the specifier, purchaser, installer, or user is drawn to the following special measures and limitations to use which must be observed when the product is taken into service to maintain compliance with the above directives:

- 1) Proper Installation of the instrument requires use of shielded cable for the loop wiring.

Details of these special measures and limitations are also contained in the product manuals.

12.0 WARRANTY STATEMENT

5 YEAR WARRANTY FOR:

KM26 Magnetic Liquid Level Gauges; MagWave Dual Chamber System; LS Series Mechanical Level Switches (LS500, LS550, LS600, LS700, LS800 & LS900); EC External Chambers, STW Stilling Wells and ST95 Seal Pots.

3 YEAR WARRANTY FOR:

KCAP300 & KCAP400 capacitance switches.

2 YEAR WARRANTY FOR:

AT100, AT100S and AT200 series transmitters; RS80 and RS85 liquid vibrating fork switches; RLT100 and RLT200 reed switch level transmitters; TX, TS, TQ, IX and IM thermal dispersion switches; IR10 and PP10 External Relays; MT2000, MT5000, MT5100 and MT5200 radar level transmitters; RI100 Repeat Indicators; KP paddle switches; A02, A75 & A77 RF capacitance level switches and A38 RF capacitance level transmitters; Buoyancy Level Switches (MS50, MS10, MS8D & MS8F); Magnetic Level Switches (MS30, MS40, MS41, PS35 & PS45).

1 YEAR WARRANTY FOR:

KM50 gauging device; AT500 and AT600 series transmitters; LaserMeter and SureShot series laser transmitters; LPM200 digital indicator; DPM100 digital indicators; APM100 analog indicators; KVIEW series digital indicators and controllers; SF50 and SF60 vibrating fork switches, KB Electro-Mechanical Continuous Measuring Devices, KSONIK ultrasonic level switches, transmitters & transducers.

SPECIAL WARRANTY CONSIDERATIONS:

ABB does not honor OEM warranties for items not manufactured by ABB (i.e. Palm Pilots). These claims should be handled directly with the OEM.

ABB will repair or replace, at ABB's election, defective items which are returned to ABB by the original purchaser within the period specified above from the **shipment date** of the item and which is found, upon examination by ABB, to its satisfaction, to contain defects in materials or workmanship which arose only under normal use and service and which were not the result of either alterations, misuse, abuse, improper or inadequate adjustments, applications or servicing of the product. **ABB's warranty does not include onsite repair or services.** Field service rates can be supplied on request.

If a product is believed to be defective, the original purchaser shall notify ABB and request a Returned Material Authorization before returning the material to ABB, with transportation **prepaid** by the purchaser. (To expedite all returns/repairs from outside of the United States, consult ABB's customer service team (service@ktekcorp.com) to determine an optimal solution for shipping method and turnaround time.) The product, with repaired or replaced parts, shall be returned to the purchaser at any point in the world with transportation prepaid by ABB for best-way transportation only. ABB is not responsible for expedited shipping charges. If the product is shipped to ABB freight collect, then it will be returned to the customer freight collect.

If inspection by ABB does not disclose any defects in material or workmanship, ABB's normal charges for repair and shipment shall apply (minimum 250.00 USD).

The materials of construction for all ABB products are clearly specified and it is the responsibility of the purchaser to determine the compatibility of the materials for the application.

THE FOREGOING WARRANTY IS ABB'S SOLE WARRANTY AND ALL OTHER WARRANTIES EXPRESSED, IMPLIED, OR STATUTORY, INCLUDING ANY IMPLIED WARRANTY OF MERCHANTABILITY OF FITNESS FOR A PARTICULAR PURPOSE, ARE EXCLUDED AND NEGATED TO THE MAXIMUM EXTENT PERMITTED BY LAW. NO PERSON OR REPRESENTATIVE IS AUTHORIZED TO EXTEND ANY OTHER WARRANTY OR CREATE FOR ABB ANY OTHER LIABILITY IN CONNECTION WITH THE SALE OF ABB'S PRODUCTS. THE REMEDIES SET FORTH IN THIS WARRANTY ARE EXCLUSIVE OF ALL OTHER REMEDIES AGAINST ABB. ABB SHALL NOT BE LIABLE FOR ANY CONSEQUENTIAL, INCIDENTAL, OR SPECIAL DAMAGES OF ANY KIND. ABB'S SOLE OBLIGATION SHALL BE TO REPAIR OR REPLACE PARTS (FOUND TO BE DEFECTIVE IN MATERIALS OR WORKMANSHIP) WHICH ARE RETURNED BY THE PURCHASER TO ABB.

Contact us

ABB Inc.

Industrial Automation
125 E. County Line Road
Warminster, PA 18974 USA
Tel: +1 215 674 6000
Fax: +1 215 674 7183

ABB Inc.

17100 Manchac Park Lane - Suite B
Baton Rouge, LA 70817 USA
Phone: +1 225 408 0800
Service: +1 225 408 0898
Fax: +1 225 408 0897
Service e-mail: service@us.abb.com

ABB Engineering (Shanghai) Ltd.

No. 4528, KangXin Hwy.
Pudong New District
Shanghai, 201319, P.R. China
Phone: +86 10 64231407
Service: +86 21 61056421
Fax: +86 10 64371913
E-mail: norman-suijun.xia@cn.abb.com
Service e-mail: rola.li@cn.abb.com

www.abb.com/level

Note

We reserve the right to make technical changes or modify the contents of this document without prior notice. With regard to purchase orders, the agreed particulars shall prevail. ABB does not accept any responsibility whatsoever for potential errors or possible lack of information in this document.

We reserve all rights in this document and in the subject matter and illustrations contained therein. Any reproduction, disclosure to third parties or utilization of its contents - in whole or in parts - is forbidden without prior written consent of ABB.

Copyright© 2017 ABB
All rights reserved