

LMILC SERIES

Mini Inverter Low Capacity Power Systems

IMPORTANT SAFEGUARDS

When using electrical equipment, basic safety precautions should always be followed, including the following:

READ AND FOLLOW ALL SAFETY INSTRUCTIONS

CAUTION

THIS UNIT PROVIDES MORE THAN ONE POWER SUPPLY OUTPUT SOURCE. TO REDUCE THE RISK OF ELECTRICAL SHOCK WHEN SERVICING, DISCONNECT BOTH NORMAL AND EMERGENCY SOURCES BY TURNING OFF THE A.C. BRANCH CIRCUIT AND BY DISCONNECTING THE BATTERY.

1. DO NOT USE OUTDOORS.
2. Do not let power supply cords touch hot surfaces.
3. Do not mount near gas or electric heaters.
4. Do not use this equipment for other than its intended use.
5. The **LMILC** should be mounted securely and in locations and at heights where it will not be readily subjected to tampering by unauthorized personnel.
6. The use of accessory equipment and replacement parts not recommended by manufacturer may cause an unsafe condition and void the warranty.
7. The AC voltage rating of this equipment is specified on the product label. Do not connect the **LMILC** equipment to any other voltage.
8. The **LMILC** uses sealed valve regulated lead acid batteries. Batteries can be punctured if not handled properly, therefore use caution when servicing batteries. In the event battery acid comes in contact with eyes or skin, flush with fresh water and consult a physician immediately.
9. The installation and use of this product must comply with all national, federal, state, municipal, or local codes that apply.
10. The **LMILC** contains potentially hazardous voltages. Installation, maintenance and service work should be performed by qualified and trained personnel.
11. Electricians and end-users need to ensure product system compatibility before final installation.
12. Units to be installed only as per configuration described in this instruction manual.

SAVE THESE INSTRUCTIONS

Please read this manual thoroughly before operating the **LMILC** Inverter System.



THIS UNIT CONTAINS A RECHARGEABLE VALVE-REGULATED LEAD ACID BATTERY. PLEASE RECYCLE OR DISPOSE OF PROPERLY.

Table of Contents

<i>Description</i>	<i>Page</i>
Section 100	
System Installation Instructions	
101. Specifications.....	3
102. Receiving, Moving and Storing Systems and Batteries.....	4
102.1 Shipping Damage.....	4
102.2 Temporary Storage of Units and Batteries.....	4
103. Installation Requirements.....	4
103.1 Operating Environment.....	4
103.2 High Altitude Operation.....	4
104. Cabinet Mounting.....	5
104.1 Tools Required.....	5
104.2 Mounting Hardware.....	5
104.3 Knockout Locations.....	5
104.4 Cabinet Mounting - Surface (-S) Models.....	5
104.5 Cabinet Mounting - Ceiling T-Grid (-T) Models.....	5
105. AC Connections.....	5
105.1 AC Wiring Preparations.....	6
105.2 AC Input Voltage Selector Plug Installation.....	6
105.3 AC Input/output Wiring Connections to Terminal Block.....	7
106. Battery Information.....	7
106.1 Tools.....	8
106.2 Battery installation and Connection.....	8
106.3 Battery Voltage Check.....	8
107. Final Installation Checklist.....	8
108. System Start-Up Procedure.....	9
109. System Test.....	9
Section 200	
Maintenance	
200.1 Safe Shut Down Procedure.....	9
200.2 Routine System Maintenance.....	9
200.3 Manual Routine Inverter Tests.....	10
200.4 Routine Battery Inspection and Maintenance.....	10
200.5 Battery Replacement Procedure.....	10
200.6 Battery Disposal.....	10
Warranty	10
Section 300	
Troubleshooting Guide.....	11

Section 100 System Installation Instructions

101. Specifications

Input

- Input voltage: Universal 120 or 277Vac.
- Input frequency: 60Hz \pm 2%
- Input surge protection: Meets UL 924

Output

- Output voltage: Universal 120 or 277Vac, 60Hz.
- Output regulation: (static) \pm 5% based on a 0% - 100% resistive load
- Minimum loading: none required
- Output distortion: Less than 3% THD linear load
- Load power factor: .44 lead to .44 lag
- Output frequency: \pm 0.3 Hz during emergency
- Time to transfer to inverter after a utility power failure: <1 second

Battery

- Battery type: Maintenance free sealed Lead Calcium
- Battery charger: Fully automatic dual-mode with temperature compensation
- Recharge time: Meets UL requirements (96 Hours)
- Battery protection: Automatic low-battery voltage disconnect and reverse polarity protection.
- Battery voltage: 12Vdc (all models)
- Runtimes: 90 minutes standard.
- Operating temperature : Lead Calcium models: 20°C to 30°C (68°F to 86°F)
- Relative humidity: 95% non-condensing

Note: Lead Calcium battery performance rated at 25°C (77°F) for load.

Table 1: (Physical Specifications)

System Model Number	Housing Mounting Style	Housing Size	Number of Installed Batteries	Housing Dimensions			System Weight*	
				Length	Height	Depth	(Lbs.)	(Kg)
LMILC32-S	Surface	Small	1	14-3/4" (37.5cm)	7-3/8" (18.7cm)	3-1/8" (7.9cm)	14	6.4
LMILC55-S	Surface	Large	1	14-3/4" (37.5cm)	7-3/8" (18.7cm)	4-3/4" (11.1cm)	18	8.2
LMILC32-T	T-Grid Ceiling Mount	--	1	23-7/8" (60.6cm)	6-1/4" (15.8)	4.0" (10.2cm)	15	6.8
LMILC55-T	T-Grid Ceiling Mount	--	1	23-7/8" (60.6cm)	6-1/4" (15.8)	4.0" (10.2cm)	19	8.6

Table 2: (Electrical Specifications)

System Model Number	Input/Output Voltage (60Hz.)	Capacity (90 Min) Watts/VA	Battery type	Power Consum. (Max)	Battery Voltage (Vdc)	DC Input Current (A dc)	Input Current		Thermal Output In BTUs		Temp. Range (°C)
							120Vac (Max.)	244Vac (Max.)	Standby	Emergency	
LMILC55	120/277	55/55	Lead-Calcium	9W	12	5.7	0.54A	0.23A	7	47	20 to 30

102. Receiving, Moving and Storing Systems and Batteries

102.1 Shipping Damage

LMILC inverter system batteries are shipped along with the unit within a single shipping carton. Batteries for most units are not shipped within the housing with the exception of Plenum Rated Ceiling Mount (T-Grid) models.

Carefully inspect all cartons upon receipt for evidence of shipping damage.

Notify carrier immediately of leaking or damaged cartons for possible concealed damage.

102.2 Temporary Storage of Units and Batteries

For temporary storage of LMILC inverter systems and batteries prior to installation, select a clean, cool, dry location with normal ventilation for human habitation and level floors.

Storage Temperature:

Store all batteries at 0° to +40° C (32° to +104° F). Batteries will have a longer shelf life if stored at 15° C (60° F). The LMILC electronics and battery cabinets may be stored at -20° to +60° C (-4° to +140° F).

IMPORTANT:

Lengthy storage of batteries will cause irreversible damage to the cells.

Failure to connect LMILC inverter system batteries to an energized charging circuit within 90 days from the date of shipment will void the battery warranty.

DANGER: Explosive - Can Cause Blindness Or Other Severe Injuries

Every type of battery can produce hydrogen gas, even sealed, maintenance-free batteries. The gas is vented through the vent caps and into the air. Do not allow smoking, sparks, or flames in battery storage location because hydrogen is concentrated under the vent cap of each cell of the battery. Hydrogen is highly explosive, and is hard to detect because it is colorless, odorless, and lighter than air.

103. Installation Requirements

103.1 Operating Environment

Install the LMILC inverter system in a clean, cool, dry place with normal ventilation for human habitation and in such a location to hamper vandalism but allow easy access for testing and maintenance.

Operating Temperature:

LMILC inverter Systems with Lead Calcium batteries are UL Listed for 20° to 30° C (+ 68° to +86° F) operation.

Battery performance and service life is maximized if the operating temperature is maintained at 25° C (77° F).

Temperature Effect On Lead Calcium Battery Performance:

Lead Calcium batteries will be less efficient at temperatures below 20° C (68° F), and high temperatures will reduce battery life. Typically, at 35° C (95° F), battery life will be half of what it would be at normal temperature of 25° C (77° F). At 45° C (113° F), battery life will be one-fourth of normal.

Ventilation:

The air around the unit must be clean, dust-free, and free of corrosive chemicals or other contaminants. Do not place the LMILC inverter system or batteries in a sealed room or container.

CAUTION:

Never Install Batteries in A Sealed Room Or Enclosure.

103.2 High Altitude Operation:

The maximum operating temperature drops 1° Celsius per 300 meters (2° F per 1000 feet) above sea level. Maximum elevation is 3000 meters (10,000 feet).

104. Cabinet Mounting

104.1 Tools Required

The following tools are required to install the system:

Socket Set, Phillips Screwdriver, Diagonal Wire Cutters, Long Nose Pliers, Electrical Tape, Digital Volt-Ohm Meter, Safety Glasses with Side Shields, Small Punch (knockout removal), Hammer, Electric Drill, Wood or Masonry Bits, Level.

104.2 Mounting Hardware

Mounting hardware is not provided. Care should be taken when selecting mounting hardware to assure that it is the proper type for the application and sized to safely support the systems full weight when installed assuring safe and secure attachment of system to wall surface or building structures. For ease of installation, the factory recommends that the head size of mounting screws or bolts be small enough to pass through the keyhole knockouts provided for mounting. This will allow the unit to be hung on partially installed mounting hardware and facilitate easy cabinet removal if ever necessary.

104.3 Knockout Locations

All models provide knockouts on the top and right-hand side of the unit.

Additional entry points, if required can be added using a metal punch. Do not drill into the cabinet as metal filings can cause short circuits and damage the equipment.

NOTE: Consider unit knockout locations prior to mounting unit. Allow room for easy routing of conduit to entry point.

104.4 Surface Mount (-S) Models:

1. Remove cover and any packing material inside unit housing that may have been used for shipping purposes.
2. Remove the appropriate knockouts, 7/8" diameter, on the top and/or right-hand side of the unit housing to facilitate conduit attachment. Also remove keyhole knockouts in the upper corners on the back of the housing.
3. Secure housing to mounting surface through both keyhole knockouts provided using mounting hardware (not supplied) sized appropriately to securely support the unit weight.



104.5 Ceiling T-Grid Mount (-T) Models:

1. Remove cover and any packing material inside unit housing that may have been used for shipping purposes.
2. Remove the appropriate knockout(s), 7/8" diameter, located on either side of unit housing to facilitate conduit attachment.



IMPORTANT: Take care to remove only the knockouts required for utility connection. Removal of knockouts if unused and left open will void the plenum rating of the unit.

3. Mount the unit securely in place between T-Grid members.



NOTICE: Safety chain or cable, rated 50 pound minimum working load, 250 pound minimum breaking strength is required to hang the unit in a T-Grid system. Failure to correctly install unit will cause an unsafe condition!

105. AC Connections

CAUTION:

- a. All **LMILC** inverter system units contain hazardous AC and DC voltages. Because of these voltages, a qualified electrician must install the **LMILC** inverter system, AC line service, and batteries. The electrician must install the AC line service according to local, state and NEC codes and must be familiar with batteries and battery installation.
- b. Before installing, maintaining, or servicing the unit, always remove or shut off all sources of AC power to the **LMILC** inverter system. Disconnect the unit battery leads to make sure the unit will not supply output voltage. Turn the AC line input circuit breaker **OFF** at the service panel.
- c. Whenever AC and/or DC voltage is applied, there will be AC voltage inside the **LMILC** inverter system unit; the unit can supply power from AC line or from its batteries. To avoid equipment damage or personal injury, always assume that there may be voltage inside the **LMILC** inverter system.
- d. Remove rings, watches, and other jewelry before installing the AC wiring. Always wear protective clothing and eye protection and use insulated tools when working near batteries. Whenever servicing an energized unit with the inside panel open, electric shock is possible; follow all local safety codes. **TEST BEFORE TOUCHING!**
- e. To reduce the risk of fire or electric shock, install the **LMILC** inverter system and the batteries in a temperature-controlled and humidity-controlled indoor area free of conductive contaminants. See **Section 103** for operating environment specifications.

105.1 AC Wiring Preparations

1. Remove the system's front cover.
2. Make sure the **LMILC** inverter system input and output voltages are correct for the particular application. Remember that the **LMILC** system provides single-phase power only.
3. The input circuit breaker in the input service panel provides the means for disconnecting AC to the **LMILC** inverter system. Only authorized persons shall be able to disconnect AC to the unit. (See **NEC 700-20 and 700-21**.)

 **CAUTION:** *To prevent electrical shock or equipment damage, for all units, make sure the **LMILC** Battery is disconnected and the AC input circuit breaker at the service panel is **OFF** before making AC connections to the **LMILC** inverter system.*

4. If not previously done, remove cabinet knockouts for AC Input and AC Output as described in **Sections 104-4, 104.5 or 104.6** depending on mounting method

 **CAUTION:** *Do not drill the cabinet; drill filings may damage the unit and prevent it from operating. If larger knockouts are needed, use a chassis punch to enlarge the appropriate knockout. Do not add additional or unnecessary knockouts.*

5. Install the input and output conduits.
6. Run the AC Input service conductors and AC Output conductors through separate conduits. **LMILC** inverter system emergency output circuits shall be installed in dedicated conduit systems and not shared with other electrical circuits as described in **NEC 700-9(b)**.

LMILC models can be configured for either 120Vac or 277Vac input connections as well as various modes of output operation as described in this section. Refer to the appropriate wiring diagrams to properly connect the utility AC power, fixtures and external switching device (where applicable). Perform all wiring procedures in accordance with applicable codes.

105.2 AC Input Voltage Selector Plug Installation

LMILC inverter systems may be operated from either 120Vac or 277Vac power sources. Determine the actual AC input line voltage and install the provided Voltage Selector Plug in the position next to the system terminal block that matches the line voltage potential as shown in the illustration below.

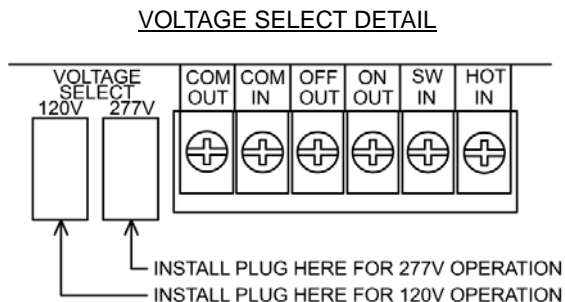

CAUTION: Failure to install the Voltage Selector Plug will prevent system operation. Installing the Voltage Selector Plug in the position that does not match the actual AC input line voltage will damage the unit, void the warranty and may cause a dangerous or unsafe condition.

105.3 AC Input/Output Wiring Connections to Terminal Block

Depending on how the fixture load is to be operated, wire the system as described below.

Normally-On Operation - Connected fixture(s) remain illuminated in AC and emergency modes.

See **Wiring Diagram 1**.

Normally-Off Operation - Connected fixture(s) illuminate only upon loss of utility AC power.

See **Wiring Diagram 2**.

Normally-On and Normally-Off Operation - A combination of the operating modes described above.

See **Wiring Diagram 3**.

Switched Load Operation - Single Circuit - Connected fixture(s) can be externally switched and will illuminate upon loss of utility AC power regardless of external switch position.

See **Wiring Diagram 4**.

Diagram 1. NORMALLY ON LOADS

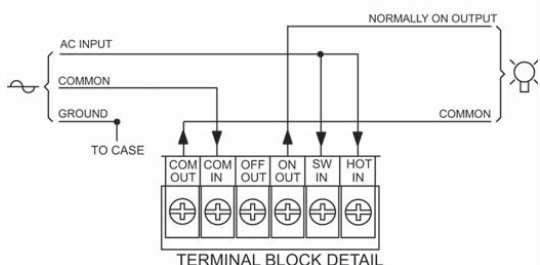

Diagram 2. NORMALLY OFF LOADS

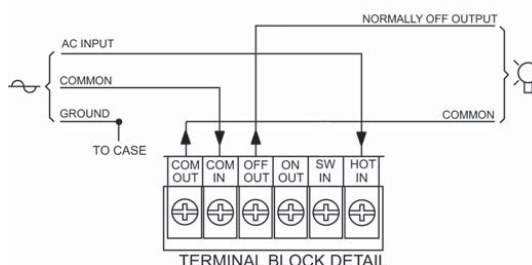

Diagram 3. NORMALLY ON & OFF LOADS

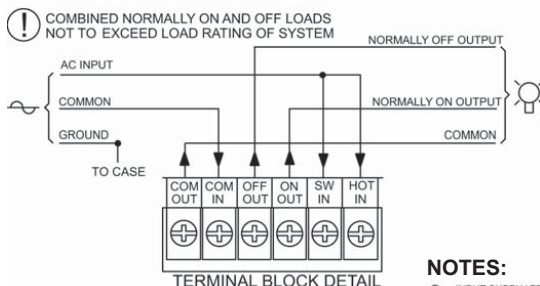
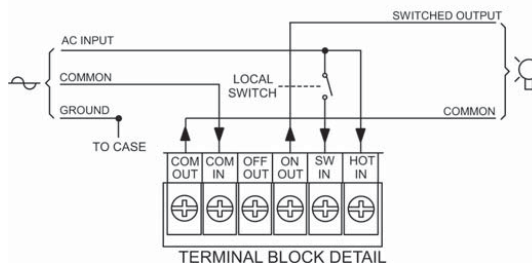

Diagram 4. SWITCHED LOADS



NOTES:

 INPUT SUPPLY FROM UNSWITCHED UTILITY RATED 20 AMPS MAXIMUM.

 OUTPUT(S) TO LIGHTING LOADS

106. Battery Information

Important Safety Precautions

The installer must take these precautions:

1. Wear protective clothing, eye-wear, rubber gloves and boots. Batteries contain corrosive acids or *caustic alkalis and toxic materials and can rupture or leak if mistreated. Remove rings and metal wristwatches or other metal objects and jewelry. Don't carry metal objects in pockets where the objects can fall onto the batteries or into the LMILC inverter system.*
2. Tools must have insulated handles so that they will not short battery terminals. Do not allow a tool to short a battery terminal to another battery terminal or to the cabinet at any time. Do not lay tools or metal parts on top of the batteries, and do not lay any objects where they could fall onto the batteries or into the cabinet.
3. Install the batteries as described in this manual. When connecting cables, never allow a cable to short across a battery's terminals or to the cabinet.
4. Keep the cable away from any sharp metal edges.
5. Install the battery leads so they cannot be pinched by the LMILC inverter system cover/door.
6. Where conductors may be exposed to physical damage, protect conductors in accordance with **NEC** requirements.
7. Full voltage and current are always present at the battery terminals. The batteries used in this system can produce dangerous voltages, extremely high currents, and possible risk of electric shock. Batteries may cause severe injury if the terminals are shorted together or to ground (earth).
Be extremely careful to avoid electric shock and burns caused by contacting battery terminals or shorting terminals during battery installation. Do not touch uninsulated battery terminals.
8. A qualified electrician who is familiar with battery systems and required precautions must install and service the batteries. Any battery used with this unit shall comply with the applicable requirements for batteries in the standard for emergency lighting and power equipment, UL 924. Cabinets are designed to be used with, and batteries must be replaced by identical cells or a Manufacturer approved equivalent. If using substitute batteries not supplied by the Manufacturer, the unit's UL listing will be void, and the equipment may fail to perform properly. The installation must conform to national and local codes as well. Keep unauthorized personnel away from batteries.

106.1 Tools

The following tools are required to install the system batteries:
Long Nose Pliers, Digital Volt-Ohm Meter, Safety Glasses

 **CAUTION:**
Always use insulated tools for battery installation.

106.2 Battery Installation and Connection

Lead-Calcium Battery Models: LMILC-32 and LMILC-55 are supplied with a single 12Vdc Lead Calcium battery. To install the unit battery, place the battery within the system housing and connect the black battery negative fly lead to the battery's black (B-) terminal. Connect the red battery positive fly lead to the battery's red (B+) terminal.

106.3 Battery Voltage Check

Using a digital volt-ohm meter, check for correct nominal battery voltage between DC Input NEG and POS wires. Voltage reading should be $\pm 10\%$ of system's nominal 12Vdc operating voltage.

107. Final Installation Checklist

 **IMPORTANT:** Before proceeding to the System Start-Up Procedure (Section 108) complete the Final Installation Checklist below.

1. Ensure the LMILC cabinet(s) is securely fastened to a wall or other structure.
2. Ensure that the input circuit breaker in the building service panel serving as the AC disconnect to the LMILC system is in the **OFF** position.
3. Check for proper ground connections in the LMILC unit cabinet.
4. Check for any loose wiring connections in the LMILC unit cabinet.
5. Check that correct nominal battery voltage (12 Vdc) is present in the LMILC unit between the battery's **NEG** and **POS** terminals.
6. Verify AC Input Voltage Selector Plug is installed and in the proper position to accept the AC input line voltage.

 **CAUTION:**
Failure to install the Voltage Selector Plug will prevent system operation. Installing the Voltage Selector Plug in the position that does not match the AC input line voltage will damage the unit, void the warranty and may cause a dangerous or unsafe condition.

108. System Start-Up Procedure

⚠ IMPORTANT: *The LMILC inverter system is a sophisticated electronic backup power supply. Care must be taken to follow the steps below in their exact sequence. Failure to do so may result in possible equipment failure.*

⚠ CAUTION: *Familiarize yourself with the shut down procedure in Section 200.1 before proceeding with the LMILC system Start Up.*

1. Apply utility AC power to the system by turning the branch circuit breaker in the main power panel to the ON position.
2. Observe the LED Status indicators and verify the following:
 - a. **AC ON** indicator (red LED) is illuminated (indicates AC utility power is available to unit).
 - b. **CHG ON** indicator (green LED) is illuminated (indicates battery is connected and charger is operational).
3. Verify **Normally-On** fixtures or switched fixtures (where applicable) are illuminated (local fixture switch must be in **ON** position).

109. System Test

Momentarily push **TEST** switch and verify the following:

- a. **INV ON status indicator (yellow) illuminates (indicates inverter is operational).**
- b. Normally-On, Normally-Off and Switched fixtures are illuminated (where applicable).

200. Maintenance

200.1 Safe Shut Down Procedure

⚠ CAUTION: *To avoid possible equipment damage or personal injury, assume that there is AC voltage present inside the LMILC inverter system unit any time AC input power or DC battery voltage is applied. The inverter is capable of providing output voltage from the batteries even when there is no AC input line voltage. When AC input voltage is present, the unit can provide output voltage even when the batteries are disconnected. Do not touch components inside the unit. DC voltage is always present at the batteries and battery cables.*

Final Shut Down Procedure

1. Open the unit's front access panel.
2. Disconnect the unit battery leads to make sure the unit will not supply output voltage.
3. Place the **AC Input circuit breaker** at the service panel in the **OFF** position.

⚠ CAUTION: *HAZARDOUS ENERGY IS STORED IN CAPACITORS INSIDE THE LMILC UNIT. AFTER TURNING OFF SWITCHES, ALLOW 5 MINUTES FOR CAPACITORS TO DISCHARGE BEFORE ATTEMPTING ANY SERVICE PROCEDURES.*

4. If the service technician does not need to access the inside of the unit, keep the unit's front cover/door closed.
5. If the unit will be shut off for an extended period of time, recharge battery every 60 to 90 days.

⚠ CAUTION: *The battery will be damaged and the warranty voided if not routinely recharged. NOTE: To turn power back on, follow the "System Start-up Procedure" outlined in Section 108. Be sure to complete all of the steps to assure the unit will operate properly.*

200.2 Routine System Maintenance

The **LMILC** inverter system unit is designed to provide years of trouble-free operation. The unit does require some routine attention to assure peak performance. The Manufacturer recommends a Preventative Maintenance check be performed by a qualified service technician at least every six months. The technician must observe important safety precautions while performing the following recommended tasks:

- **Inspect and clean the unit interiors;**
- **Inspect all batteries for leaks, case swelling or terminal corrosion;**
- **Perform an emergency operation test to check operation of all critical connected loads**

200.3 Manual Routine Inverter Tests

NFPA101 requires that Emergency Lighting Equipment be tested on a monthly basis for a period of at least 5 seconds, and a minimum of 90 minutes once a year. We strongly recommend these guidelines be followed to ensure system readiness, and to prolong battery life. The **LMILC** system was designed with a front panel test switch to facilitate monthly testing. Simply depress the button and hold to test the inverter at anytime. Once released, the **LMILC** will revert back to standby operation. For annual 90-minute discharge or other prolonged tests, simply turn off the AC Input breaker at the service panel.

200.4 Routine Battery Inspection and Maintenance

Sealed Lead-Calcium Batteries

Maintenance-free cells are the most common type of battery used today in standby equipment. By design it is as maintenance free as a battery can be. It is recommended, however, that some simple steps be taken to increase system life and maximize reliability:

- A quarterly visual check of the battery should be conducted to look for deformities in the battery case, electrolyte leakage and/or terminal corrosion. Any batteries with these conditions are defective and should be replaced. Any corroded terminals found, regardless how slight, are to be cleaned at once to prevent system failure.
- Once a year, all battery connections should be checked for tightness and cleaned and re-tightened as necessary.

200.5 Battery Replacement Procedure

WARNING:

Always use the same quantity and type of battery as replacements.

Substituting batteries not supplied by the Manufacturer will void the UL listing of the system and may cause equipment failure. To ensure the superior performance of your **LMILC** inverter system and to maintain proper charger operation, replace spent batteries only with those having the same part number, voltage and ampere-hour rating as the original batteries.

Follow the proper shut down procedure as described in **Section 200.1**.

Disconnect the battery Positive red (B+) and Negative black (B-) connectors.

Remove the battery from the cabinet.

Install new battery following the instructions outlined in **Section 106.2**.

200.6 Battery Disposal

WARNINGS:

- *Do not dispose of batteries in a fire, the batteries could explode.*
- *Do not open or mutilate batteries.*
- *Released electrolyte is highly toxic and harmful to the skin and eyes.*

CAUTION:

Batteries contain lead. Many state and local governments have regulations about used battery disposal. Please dispose of the batteries properly.

WARRANTY

When operated under normal conditions, Lightalarms® inverter products will provide years of dependable service. This unit is backed by a 3-7 year warranty. The unit is covered by a complete 3-year warranty against defects in material or workmanship, and a 7-year pro-rata battery warranty.

300 TROUBLESHOOTING GUIDE

The following steps will help verify the operational status of the **LMILC** series. Servicing of the **LMILC** series should only be performed by qualified personnel. Always follow all cautions and safeguards when working with electrical equipment.

LMILC Troubleshooting

1. Open the unit's front access panel.
2. Disconnect the unit battery leads to make sure the unit will not supply output voltage.
3. Place the **AC Input circuit breaker** at the service panel in the **OFF** position.
4. Disconnect the load wires connected at the normally on and normally off outputs.



CAUTION:

HAZARDOUS ENERGY IS STORED IN CAPACITORS INSIDE THE LMILC UNIT. AFTER TURNING OFF SWITCHES, ALLOW 5 MINUTES FOR CAPACITORS TO DISCHARGE BEFORE ATTEMPTING ANY SERVICE PROCEDURES.

5. Verify that all three LED lights (**Yellow, Red, and Green**) are off.
6. Check the battery voltage. If the battery is charged, the voltage should be **>12.5VDC**. If discharged, it may be as low as 12VDC. If the battery voltage is too low, the output may not energize.
7. Check the position of the Voltage Selector Plug next to the system terminal block. Make sure it matches the line voltage.
8. Connect the black battery negative fly lead to the battery's black (B-) terminal. Connect the red battery positive fly lead to the battery's red (B+) terminal.
9. Apply utility AC power to the system by turning the branch circuit breaker in the breaker panel to the ON position.
10. Observe the LED Status indicators and verify the following:
 - a. **AC ON** indicator (red LED) is illuminated (indicates AC utility power is available to unit).
 - b. **CHG ON** indicator (green LED) is illuminated (indicates battery is connected and charger is operational).
11. Check the battery voltage. If the batteries are sufficiently charged, the measured battery float voltage should be between 13.5 and 13.8 VDC. This indicates that the **LMILC** is properly charging the battery.
12. Momentarily push the **TEST** switch and verify the following:
 - a. **INV ON status indicator (yellow) illuminates (indicates inverter is operational).**
 - b. Depending on how the fixture load is to be operated, output voltage (120V or 277V depending on the position of the Voltage Selector Plug) will be present at the Normally-On and Normally-Off outputs. This will confirm that the **LMILC** is properly inverting the DC output of the battery.

The steps above would indicate that the **LMILC** is working properly. Follow the steps below to determine if there is a problem with the load.

Load Troubleshooting

1. With the load wires disconnected, check with a voltmeter the voltage across them to make sure there is no backfeed voltage of any type. In some instances, the circuit has been accidentally tapped 'downstream' of the inverter.
2. Disconnect the unit battery leads to make sure the unit will not supply output voltage.
3. Disconnect the primary AC circuit from the **LMILC** and connect the load wires directly to the primary AC circuit. This will bypass the **LMILC**.
4. Turn the upstream branch circuit breaker back to the ON position.
5. Confirm that all emergency lights come on. Check the amperage on the circuit. The amperage should not exceed the output current rating of the unit. The output current rating of the unit is obtained by dividing the VA rating by the voltage.
6. If less than the rated value, reconnect the load and primary AC circuit to the **LMILC**. Make sure all power sources are turned off prior to wiring. Reconnect the battery leads. Apply utility AC power to the system by turning the branch circuit breaker in the breaker panel to the ON position. Test the **LMILC** by pressing the Test Switch. All lights on the circuit should be lit and the yellow LED ("INV ON") should turn on. The Green ('CHG') LED should turn off.
7. The red LED (**AC ON**) indicates AC utility power is available to unit. The green LED (**CHG ON**) indicates battery is connected and charger is operational. The yellow LED (INV ON) indicates the inverter is operating and will be lit when the TEST switch is pressed or during a power outage.



If problems persist, contact Lightalarms Customer Service for further review of the application.

For service or installation information contact.

Technical Support:

Tel. : 1-888-552-6467 • Fax: 1-800-316-4515

www.lightalarms.com

All information and specifications contained in these instructions are subject to change due to engineer design, errors and omissions.

© 2014 Thomas & Betts Limited. All rights reserved.