

# INSTALLATION AND WIRING

BDS0029 rev 16

## Cylon® FBXi

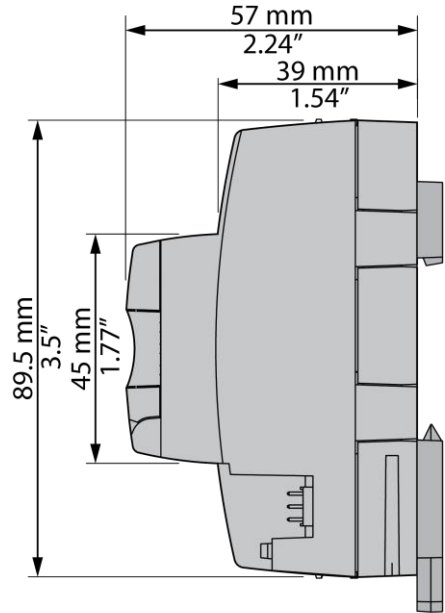
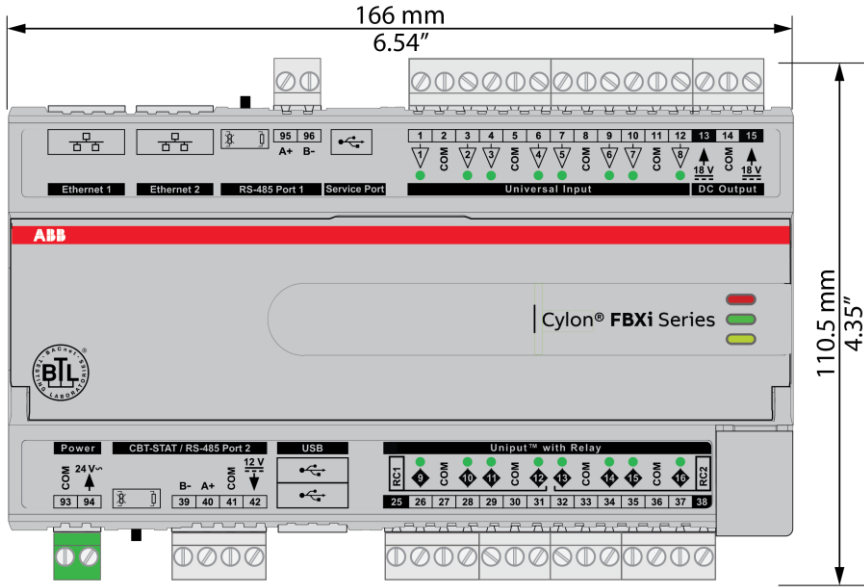

### FBXi-8R8-X96 / FBXi-8R8-H-X96:

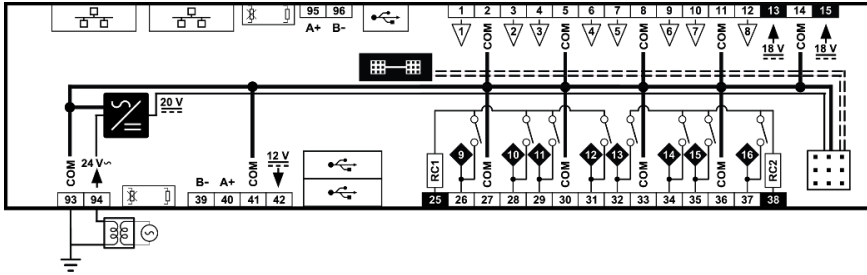





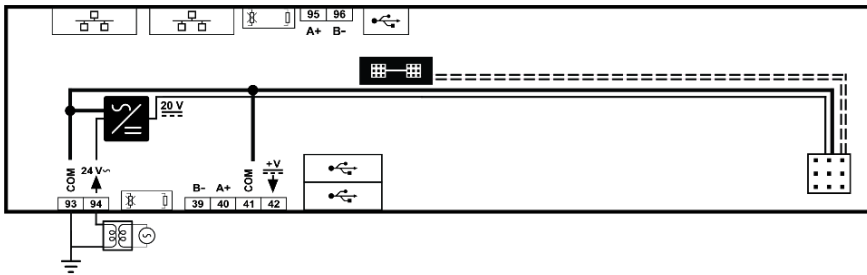

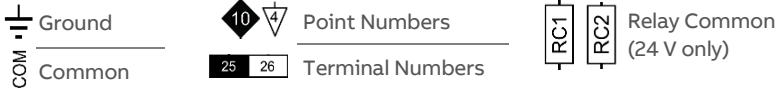

**CAUTION** - DANGER OF EXPLOSION IF BATTERY IS INCORRECTLY REPLACED. REPLACE ONLY WITH THE SAME OR EQUIVALENT TYPE RECOMMENDED BY THE MANUFACTURER. DISPOSE OF USED BATTERIES ACCORDING TO THE MANUFACTURER'S INSTRUCTIONS.

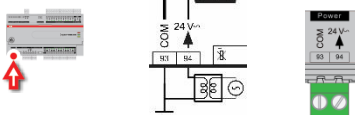

### FBXi-X256 / FBXi-X48:



Supply Requirements	24 V AC ±20 % 50/60 Hz	
Supply Rating	FBXi-8R8(-H)-X96	30 VA (no FLX modules)
	FBXi-8R8(-H)-X96 + 1 x FLX	42 VA
	FBXi-8R8(-H)-X96 + 2 x FLX	54 VA
	FBXi-8R8(-H)-X96 + 3 x FLX	66 VA
	FBXi-X256/FBXi-X48	20 VA (no FLX modules)
	FBXi-X256/FBXi-X48 + 1 x FLX	32 VA
	FBXi-X256/FBXi-X48 + 2 x FLX	44 VA
	FBXi-X256/FBXi-X48 + 3 x FLX	56 VA
	FBXi-X256 + 4 x FLX	68 VA
	FBXi-X256 + 16 x FLX	68 VA
FLX Power Connection	Proprietary FLX bus connector carries power and comms from FBXi Series unit. FBXi can supply power to up to 3 FLX modules.	
Auxiliary Power	18 V DC / 60 mA output	
BACnet Loading	¼ unit load device	

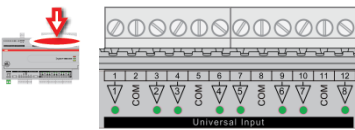
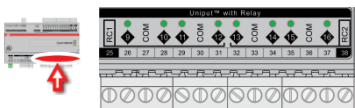
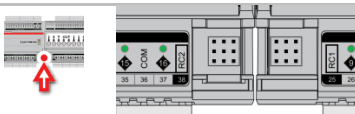
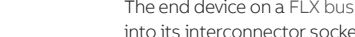
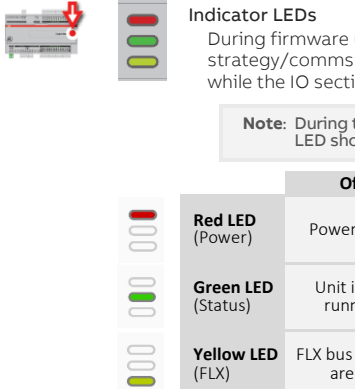

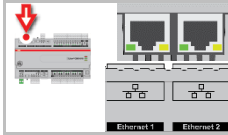
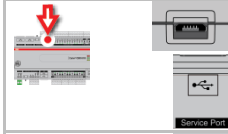
	Terminal Numbers	Description																				
	93, 94	<b>24 V AC Power</b> <b>Important:</b> The common power connection (terminal 93) must be connected to Earth. ABB Cylon recommend that this is done at the 24 V AC transformer.																				
	13 ... 15	<b>Auxiliary Power: 18 V DC output on 2 terminals, 60 mA total</b>																				
	95, 96	<b>RS-485 Port 1 (BACnet® MS/TP) screw terminal</b> MS/TP subnet terminator switch is located beside the port. If the switch is towards the  , then termination is <b>in</b> and if the switch is towards the  , then termination is <b>out</b> .																				
	39 ... 42	<b>Sensor / RS-485 Port 2 (Cylon® room sensors or BACnet® MS/TP or Modbus RTU)</b> The bus Terminator Switch is located beside the port. If the switch is towards the  , then termination is <b>in</b> and if the switch is towards the  , then termination is <b>out</b> .																				
 <p>When input is configured as <b>Resistor/thermistor</b>:</p> <ul style="list-style-type: none"> <li>LED <b>Off</b>: valid resistance connected (<b>Note</b>: 0 Ω is counted as valid)</li> <li>LED <b>Slow blink</b>: resistor/thermistor not connected</li> </ul> <p>When input is configured as <b>Analog</b>:</p> <ul style="list-style-type: none"> <li>LED intensity is modulated by the analog signal</li> </ul> <p>When the LED is blinking:</p> <ul style="list-style-type: none"> <li><b>Fast blink</b> indicates error condition</li> <li><b>Two short flashes followed by a value*</b> indicates the input is in an override state (overridden by CXpro<sup>HD</sup>).</li> </ul> <p><b>*Note:</b> The LED intensity illustrates the value measured at the input terminals. The flash indicates that this value has been overridden.</p>	1 ... 12	<b>Universal Inputs</b> When input is configured as <b>Digital</b> : <ul style="list-style-type: none"> <li>LED <b>Off</b>: open circuit or logic 'off'</li> <li>LED <b>On</b>: logic 'on'</li> </ul>																				
 <p>When output is configured as <b>Digital</b>:</p> <ul style="list-style-type: none"> <li>LED <b>Off</b>: open circuit or logic 'off'</li> <li>LED <b>On</b>: logic 'on'</li> </ul> <p>When output is configured as <b>Analog</b>:</p> <ul style="list-style-type: none"> <li>LED intensity is modulated by the analog signal</li> </ul> <p>When the LED is blinking:</p> <ul style="list-style-type: none"> <li><b>Fast blink</b> indicates error condition</li> </ul> <p><b>Two short flashes followed by a value</b> indicates the output is in an override state (overridden by CXpro<sup>HD</sup> or HOA).</p>	25 ... 38	<b>UniPutS™ + Relay</b> When a Uniput channel is configured as an input, the LED signals are identical to Universal Inputs above. When configured as an output the following apply:																				
		<b>Inter-module connection sockets</b> To join the FLX bus, place the devices side-by-side and place the <b>FLX bus connector</b> into the two adjacent sockets at once.																				
		The end device on a FLX bus (either a <b>FLX</b> device or the <b>CBXi</b> itself) must have a terminator inserted into its interconnector socket. One terminator is shipped with each <b>CBXi-8R8(-H)</b> device.																				
 <p><b>Indicator LEDs</b></p> <p>During firmware upgrade over IP network, the Yellow LED will remain on while the strategy/comms section reboots, and then the LEDs will rotate Red-Green-Yellow while the IO section reboots.</p> <p><b>Note:</b> During typical operation, the Red LED should be on, the Green LED should be blinking and the Yellow LED should be off.</p> <table border="1"> <thead> <tr> <th></th> <th>Off</th> <th>On</th> <th>Slow Blink</th> <th>Fast blink</th> </tr> </thead> <tbody> <tr> <td><b>Red LED (Power)</b></td> <td>Power is off</td> <td>Power is on</td> <td>— Unit Rebooting —</td> <td></td> </tr> <tr> <td><b>Green LED (Status)</b></td> <td>Unit is not running</td> <td>Strategy Loaded but no network connectivity</td> <td>Strategy Loaded and device communicating on network</td> <td>No Strategy loaded</td> </tr> <tr> <td><b>Yellow LED (FLX)</b></td> <td>FLX bus comms are ok</td> <td>No FLX bus comms</td> <td>FLX bus address clash</td> <td>FLX bus comms error</td> </tr> </tbody> </table>		Off	On	Slow Blink	Fast blink	<b>Red LED (Power)</b>	Power is off	Power is on	— Unit Rebooting —		<b>Green LED (Status)</b>	Unit is not running	Strategy Loaded but no network connectivity	Strategy Loaded and device communicating on network	No Strategy loaded	<b>Yellow LED (FLX)</b>	FLX bus comms are ok	No FLX bus comms	FLX bus address clash	FLX bus comms error		
	Off	On	Slow Blink	Fast blink																		
<b>Red LED (Power)</b>	Power is off	Power is on	— Unit Rebooting —																			
<b>Green LED (Status)</b>	Unit is not running	Strategy Loaded but no network connectivity	Strategy Loaded and device communicating on network	No Strategy loaded																		
<b>Yellow LED (FLX)</b>	FLX bus comms are ok	No FLX bus comms	FLX bus address clash	FLX bus comms error																		

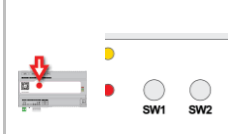
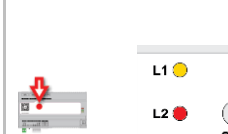
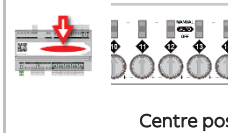
	<b>Ethernet Ports</b>
	<b>Service Port (Micro USB)</b>
	<b>USB ports</b> Used for firmware upgrade
 <p><b>Reset to Factory default IP/Password:</b> while the controller is <i>running</i>, press <b>SW1</b> until LED <b>L2</b> lights up, then release <b>SW1</b>.</p> <p><b>Restart the controller:</b> while the controller is <i>running</i>, press <b>SW2</b> until LED <b>L2</b> lights up, then release <b>SW2</b>.</p> <p><b>Factory Reset (Reset to default Factory settings including, Shipped version of firmware, wipe strategy data, and reset IP/Password):</b> while the controller is <i>booting</i> hold <b>SW1</b> until LED <b>L2</b> lights up, then release <b>SW1</b>. <b>LED L2 will indicate the progress as shown in L1/L2 signals below.</b></p> <p><b>USB upgrade:</b> insert a FAT-formatted USB drive containing valid firmware (.swu) into either of the USB ports, while the controller is <i>booting</i> hold <b>SW1</b> until LED <b>L1</b> lights up, then release <b>SW1</b>. <b>LED L1 will indicate the progress as shown in L1/L2 signals.</b></p>	<b>Push buttons</b> <b>Reset to Factory default IP/Password:</b> while the controller is <i>running</i> , press <b>SW1</b> until LED <b>L2</b> lights up, then release <b>SW1</b> . <b>Restart the controller:</b> while the controller is <i>running</i> , press <b>SW2</b> until LED <b>L2</b> lights up, then release <b>SW2</b> . <b>Factory Reset (Reset to default Factory settings including, Shipped version of firmware, wipe strategy data, and reset IP/Password):</b> while the controller is <i>booting</i> hold <b>SW1</b> until LED <b>L2</b> lights up, then release <b>SW1</b> . <b>LED L2 will indicate the progress as shown in L1/L2 signals below.</b> <b>USB upgrade:</b> insert a FAT-formatted USB drive containing valid firmware (.swu) into either of the USB ports, while the controller is <i>booting</i> hold <b>SW1</b> until LED <b>L1</b> lights up, then release <b>SW1</b> . <b>LED L1 will indicate the progress as shown in L1/L2 signals.</b>
	<b>LED L1 / LED L2 signals</b> Slow blink: Upgrade / Reset in progress Solid colour: Upgrade / Reset successful. Power-cycle the controller to activate. Fast blink: Upgrade / Reset failed
	<b>Output Override (FBXi-8R8-H-X96 only)</b> <b>Bottom position:</b> Off - outputs forced off. <b>Centre position:</b> Auto - outputs are controlled by strategy. <b>Top position:</b> Manual - for digital outputs, the output is forced on. For analog outputs the knob setting controls the output value. <b>Note:</b> Manual position is supervised, i.e. the strategy is aware of the manual value.