

APPLICATION NOTE

## Lamp starting solutions

Optimized for greenhouse horticulture and indoor food farming



---

## Lamp starting solutions for grow lights

The challenge of a growing world population along with the shortage of arable land are stimulating the global indoor food farming market. This is mainly due to land degradation, transformation of land for human settlements and infrastructure projects. In addition, various social, political, and climatic factors favor the development of new agricultural approaches to produce food inside enclosed environments.

Especially the cultivation of plants can benefit from the advantages of closed and protected environments, preventing bad weather, diseases or insects to be an obstacle for the production of conventional crops. Depending on the location and the type of crop it can be useful to introduce artificial lighting for both conventional greenhouses as well as vertical farms, that are typically placed in urban areas.

ABB is a long-standing advocate of the need for reliable control and protection products for grow lights used in greenhouse horticulture and indoor food farming. Our policy is not only to offer energy efficient products, but we take a lifecycle approach, seeking to minimize the costs and environmental impact associated with our products throughout their lifetime.

---

# Table of contents

<b>4</b>	<b>Foreword</b>
<b>5</b>	<b>Introduction</b>
<b>6</b>	<b>Components for lamp starter cabinets</b>
<b>7</b>	<b>Structure of horticultural greenhouses</b>
<b>8</b>	<b>Lamp starter cabinets</b>
<b>9</b>	<b>Lamp starter combination description</b>
<b>15</b>	<b>Technical data</b>
15	Lamp circuit breakers
17	Lamp contactors
19	OT disconnect switch
20	MCCB Tmax XT, 250 A with residual current device
22	Busbar adapter
<b>26</b>	<b>Normative references</b>

---

## Foreword

ABB is a pioneering technology leader in electrification products, robotics and motion, and industrial automation, serving customers in utilities, industry, and transport and infrastructure globally. Continuing a history of innovation spanning more than 130 years, ABB today is writing the future of industrial digitalization with two clear value propositions: bringing electricity from any power plant to any plug and automating industries from natural resources to finished products.

This application note is written as a general guide for people working with low-voltage switchgear and controlgear applications for greenhouse horticulture and similar indoor food farming applications.

ABB suggests to follow the recommendations described in this document to ensure proper usage of especially ABB's lamp circuit breakers (MS132-L and MS132-LC) and lamp contactors (AF...-L) before being put into service. The following recommendations describe several factors that should be considered when selecting the right products and engineering the right solution for a specific greenhouse horticulture or indoor food farming application.

ABB is constantly monitoring changes in the market for greenhouse horticulture and similar applications like vertical farms, to ensure timely adaptation of relevant products to meet the requirements of the latest developments in this segment.

All information provided in this application note is only general and each application must be handled as a specific case. Be sure to always follow all national and local installation regulations/codes for your specific application. Nonetheless any clause to the contrary, ABB shall not be liable for any damages, claims or losses, etc., directly, or indirectly related to this application note.

# 1 Introduction

Lamp starter cabinets in greenhouse horticulture applications face several specific challenges. In large greenhouses, for example, it can be considered best practice to place the panels between the plants. This is mainly to reduce cable lengths. Due to the possible presence of aggressive substances (e.g. herbicides or fertilizers) and high humidity along with high temperatures they are typically rarely ventilated, to not expose electrical components to this atmosphere. At the same time the space available for the cabinets is usually limited, mainly to prevent shadow being a disturbing factor for plant growth and harvest.

ABB's lamp starting solutions for assimilation lighting are optimized for cabinets in greenhouses and other indoor food farming applications.

The lamp starter combination consists of a MS132-L or MS132-LC lamp circuit breaker and an AF-...L lamp contactor. It can be either mounted on a DIN rail adapter or a mounting plate. Another alternative, that is often utilized in greenhouse assimilation lighting cabinets, is the usage of a busbar energy distribution system. A busbar energy distribution system allows an easy, safe and fast mounting of various components by clipping them on the busbar system.

The lamp starters provide protection against high short-circuit current levels of up to 100 kA at 400 V AC, which is especially useful in a greenhouse complexes, where the panels with the lamp starters are placed relatively close to the transformers. Additionally ABB's lamp starters protect the lights and lines against the effects of overloads and phase failures. Furthermore they allow remote switching of the lamps and provide a manual disconnect function, to safely separate the lines from the load in case of maintenance. At the same time ABB's lamp starters have a considerably low heat dissipation, contributing to acceptable temperatures in the grow lights control cabinets. The latest generation lamp starters generate around 10 percent less heat compared to previous versions. The lamp contactors in particular even generate approximately 20 percent less heat. In addition, the temperature compensation feature of the lamp starter ensures suitable overload protection at ambient temperatures in the greenhouse or indoor food farm of up to 60 °C (70 °C with de-ratings).

Last but not least, ABB's new generation of lamp starters have a width of 45 mm, reducing the overall space requirements in the panel. In applications where the optional busbar system is used and the temperature inside the cabinet is critical, this allows to use rail adapters with a reduced width of 54 mm. This means 17 % (or 9 mm) less space in width per lamp starter, compared to previous solutions. This results in an air gap of 4.5 mm on each side of the lamp starters, with the advantage of an optimized thermal distribution inside the cabinet.



## 2 Components for lamp starter cabinets

The design of lamp starter cabinets for horticultural greenhouse or vertical farming applications requires the collection and evaluation of relevant environmental parameters and electrical data. To support this activity, incl. the selection of the right components, ABB has created a dedicated questionnaire (document number: 2CDC131109D0201). Below tables show electrical components, that are typically used to setup lamp starting solutions for grow lights. Please contact your ABB sales representative for further information.

### Lamp circuit breakers

Type	Setting range	Order code
MS132-16L	10 ... 16 A	1SAM350100R1011
MS132-20L	16 ... 20 A	1SAM350100R1013
MS132-25L	20 ... 25 A	1SAM350100R1014
MS132-10LC	6.3 ... 10 A	1SAM350300R1010
MS132-16LC	10 ... 16 A	1SAM350300R1011
MS132-20LC	16 ... 20 A	1SAM350300R1013

### Lamp contactors

Type	Rated control circuit voltage	Order code
AF16-40-00L-13	100-250 V 50/60 HZ-DC	1SBL177281R1300
AF16-40-00L-14	250-500 V 50/60 HZ-DC	1SBL177281R1400
AF26-30-00L-13	100-250 V 50/60 HZ-DC	1SBL237081R1300
AF26-30-00L-14	250-500 V 50/60 HZ-DC	1SBL237081R1400

### MCCB with residual current device

Please refer to ABB MCCB catalog:

<https://new.abb.com/low-voltage/products/circuit-breakers/xt>

### OT disconnect switches

Type	Order code
OT315E03W	1SCA022809R8570
OT 315E03WP	1SCA022809R8650
OT 400U03P	1SCA022718R9670
OT 315E04W	1SCA022809R9030
OTS 400G1L/3	1SCA022736R8840
OTS 400G1L/4	1SCA022736R9490
OTV 400EK	1SCA022763R2960
OHB 95J12	1SCA022381R0830
OXF 12X250	1SCA022325R6980

### Monitoring relays

Type	Order code
CM-PBE	1SVR550882R9500
CM-PVE	1SVR550871R9500
CM-PFS.S	1SVR730824R9300
CN-TCN.011S	1SVR750740R0110

## Interface relays

Type	Order code
CR-M2SS	1SVR405651R1000
CR-M024DC2L	1SVR405611R1100
CR-M024AC2L	1SVR405611R0100
CR-S024VADC1CRZ	1SVR405541R3210
CR-S024VADC1CRS	1SVR405541R3110

## 3 Structure of horticultural greenhouses

The typical design for the electrical energy distribution in horticultural greenhouses reflects the fact, that the power consumption is usually quite high. Hence the distance between the transformers used to transfer electrical energy from the grid to the cabinets for the load supply, e.g. the lamps, is quite close. The lamps are then supplied from these panels. It can be considered best practice to structure the grow lights in groups within an individual panel.

By switching dedicated lighting groups, the light output in the greenhouse can be controlled to have e.g. 25, 50, 75 or 100 percent of the light intensity. Alternatively, if sufficient natural light is available in the greenhouse, the lighting can be switched off. The nominal voltage of the system is typically 400 V AC, 3-phase without neutral.

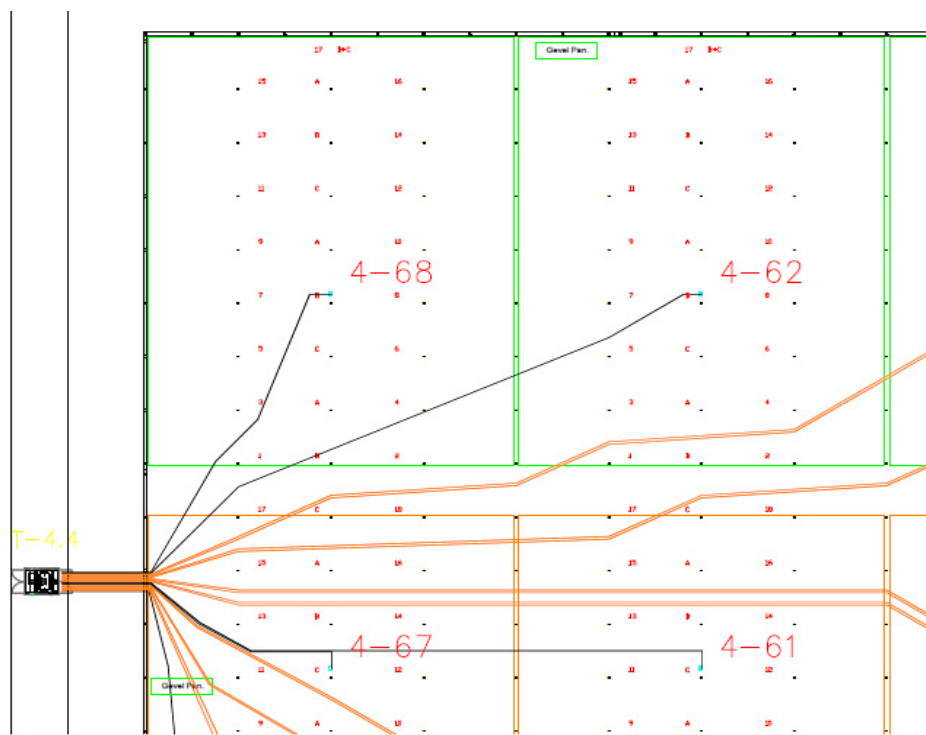

01 Example of a greenhouse layout.  
Every dot represents a fixture, every number stands for a cabinet

## 4 Lamp starter cabinets

Exemplary dimensions of a panel used for lamp starters are (L\*W\*H) 2000\*380\*210 mm, but this may depend on the lighting structure, type of lamp technology, panel builders and type of agricultural crop. It can be considered best practice to position the panels in a way that assures as little as possible shadow over the crops.

The panels are usually min. IP44 protected, which is mainly due to the environmental conditions and airborne particles inside the greenhouses, which could have a negative effect on the electrical components. Another issue could be the potentially high level of humidity, which may lead to corrosion of the electrical components. It could for example be a reality, that insurance companies will not provide coverage for the electrical installations, if the boards are not sealed airtight. A typical arrangement of the components inside the panel is shown in image three and four.

In addition, especially in European installations, the standard EN/IEC 60364-7-705 might require the usage of residual current devices (RCDs) with 300 mA. This may be mandatory in certain countries and has to be implemented in a suitable design. For example, in the Netherlands the standard NEN1010:2015 art 705.411.1 requires the use of RCDs in the segment agriculture, horticulture and livestock farming.



02 Example for the position of a lamp starter cabinet in a horticultural greenhouse

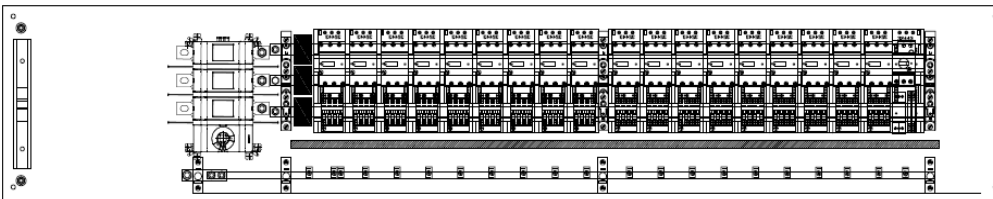

03 Typical layout of a lamp starter cabinet with a disconnect switch

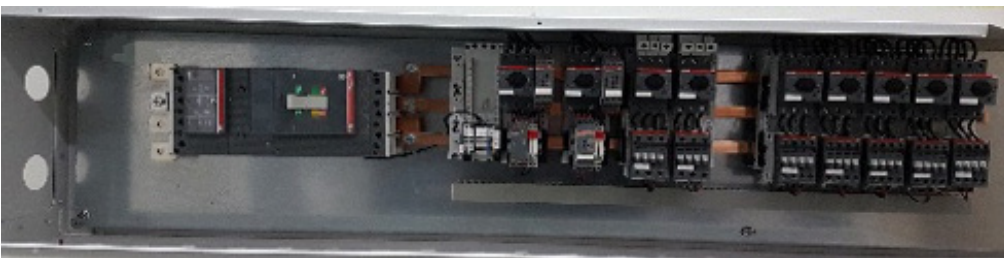

04 Example layout of a lamp starter cabinet with MCCB and (optional) RCD



**Lamp starter panels typically consist of:**

- Enclosure (min. IP44)
- Busbar system (optional)
- MCCB with residual current device (optional country specific, if required)
- Busbar adapters for lamp starter combinations (optional)
- Lamp starter combinations (MS132-L/-LC lamp circuit breakers and AF...-L lamp contactors)
- OT disconnect switch (optional, if no MCCB with RCD is used)
- Control interface to upstream assimilation lighting (management) system
- Lockable handle

## 5 Lamp starter combination description

The lamp starter controls the lamp loads and provides protection for the lamps and installations.

The main functions are:

- Overload protection
- Short-circuit protection
- Phase loss sensitivity
- Disconnect function
- Switching lamp loads (remote and local)
- Adjustable current setting for overload protection
- Temperature compensation: -25 ... +60 °C



05 Lamp starter



06 Lamp starter on a bus bar adapter

The lamp starter combination is used to control and protect the lamps and the cables. It is typically set up with a MS132-L or MS132-LC lamp circuit breaker and an AF16-...L or AF26-...L lamp contactor.

The three-pole lamp circuit breaker MS132-L or MS132-LC has thermal tripping elements for overload and phase failure protection and electromagnetic tripping elements for short-circuit protection. Furthermore, it is suitable for isolation of the installation from the supply. This is important, e.g. for maintenance work. The lamp circuit breakers have a setting scale in amperes, which allows the direct adjusting of the devices to the individual lamp load structures.

The AF16...L and AF26-...L lamp contactors incorporate an electronically controlled coil that offers multiple benefits, like a reduced energy consumption.

The lamp starters consisting of lamp circuit breakers MS132-L/LC and lamp contactors AF16-...L/AF26-...L are often mounted on a busbar adapter and snapped on the respective busbar system. This combination is type-tested by ABB for use in lighting applications, especially in horticultural greenhouses. These lamp starters are placed in the panel and each starter is for example connected with nine lamps of 1000 W / 400 V AC. The lamps are protected per lighting group. When a lamp error occurs in one lighting group, only this group will switch off.

The lamps are usually mounted in a checkerboard pattern to ensure an uniform light distribution, even if only 25, 50 or 75 percent of the lamps are switched on. By switching dedicated lighting groups, the light output in the greenhouse can be controlled to have e.g. 25, 50, 75 or 100 percent of the light intensity. Alternatively, if sufficient natural light is available in the greenhouse, the lighting can be switched off. Typically, nine lamps are connected between the phases per lamp starter. They are in delta connection L1-L2, L2-L3 and L1-L3.

**MS132-L vs. MS132-LC**

The decision whether MS132-L or MS132-LC should be used as part of a lamp starter is mainly depending on following factors:

- Lamp power consumption
- Lamp inrush current
- Inrush impulse duration
- Cable length / total impedance

The main difference between MS132-L and MS132-LC is the magnetic tripping current, that causes the magnetic release of the lamp circuit breakers to react and ultimately disconnect the loads from the power supply by opening the main contacts in case of a short-circuit.

While MS132-L has a magnetic tripping current at 15 x nominal current  $I_n$  (+/- 20%), MS132-LC will already trip at 7.5 x nominal current  $I_n$  (+/-20%) which is more limited as an MCB with C-characteristic in case of a short-circuit (for indication see attached characteristics of MS132-xL and MS132-xLC in red compared to MCB).

C characteristic

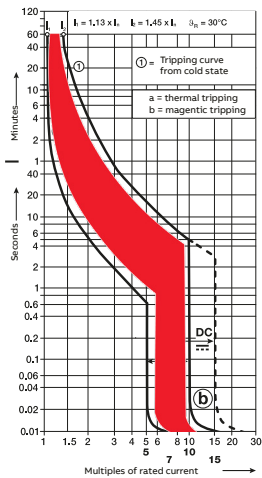

$C = 5 - 10 \times I_n$   
 MS132-LC =  $7.5 \pm 20\% = 6 - 9 \times I_n$

D characteristic

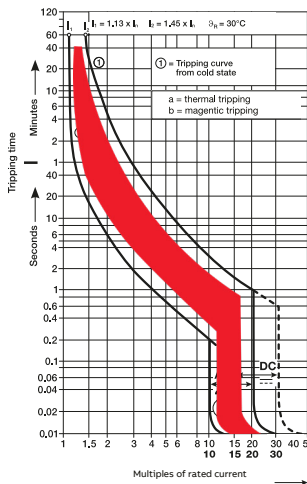

$D = 10 - 20 \times I_n$   
 MS132-L =  $15 \pm 20\% = 12 - 18 \times I_n$

07 Tripping characteristic of MS132-L / MS132-LC

In the application it is important to check the max. impedance (lamp starter, cable and fixture) to validate the magnetic tripping ability.

Especially with long cables and numerous lamps, the resulting high impedance and the voltage drop has to be considered for the validation of a magnetic tripping of the lamp circuit breaker.

Moreover, it is worth noting that using MS132-LC, particularly in conjunction with LED lights that draw comparatively low inrush currents and power consumption, typically allows longer cable distances and more lamps per phase. Additionally, it should be highlighted that in certain circumstances, utilizing both MS132-L and MS132-LC might be necessary. Such a scenario may arise, for instance, if two distinct lamp types are used simultaneously, such as high-power HPS or LED lamps as top lights and LED interlights.

The ultimate choice which lamp circuit breaker has to be used should always be taken based on the electrical design of the specific application.

With the use of public available cable calculation programs and applying the application specific factors, the maximum cable length, voltage drop and max. permissible current depending on the wire size can be evaluated and be used for the design.

The table below shows the variances of the cable length based on the wire size with indicated current carrying capacity  $I_z$  and voltage drop (suitable cable calculation programs are provided by the market).

#### MS132-L

	Minimum	Optimum	Oversized
Wire size	2.50 mm <sup>2</sup>	2.50 mm <sup>2</sup>	6 mm <sup>2</sup>
Max. cable length	30 m	49 m	73 m
Current carrying capacity $I_z$	32 A	42 A	54 A
Voltage drop	1.99 %	1.25 %	0.83 %

#### MS132-LC

	Minimum	Optimum	Oversized
Wire size	2.50 mm <sup>2</sup>	2.50 mm <sup>2</sup>	6 mm <sup>2</sup>
Max. cable length	61 m	98 m	146 m
Current carrying capacity $I_z$	32 A	42 A	54 A
Voltage drop	3.09 %	1.94 %	1.30 %

#### Variations of fixtures

Different crops and growing technologies in greenhouses require dedicated lamp solutions. Common designs of lamps are shown as examples below. The fixture design and lamp parameters are subject to continuous improvement to enhance light output, decrease energy consumption, increase reliability and lifespan, and standardize applications.

- HPS lamps (High Pressure Sodium Lamps)
- LED lamps (Light Emitting Diodes Lamps).

#### Typical power of fixtures

- 600 W - HPS
- 1000 W - HPS
- 1000W - LED

#### Mounting positions of fixture

SON-T toplights



LED toplights



LED interlights

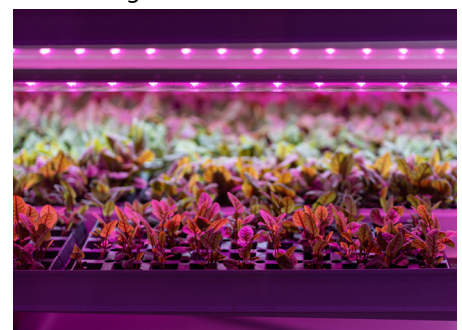

08 Mounting positions of fixtures

Each lamp design has its unique physical and electrical parameters, distinct startup characteristics, and operational behavior.

For the design of lamp starter panels for greenhouse horticulture applications, certain analysis, considerations, and rules must be taken into account. Below are some examples of such requirements.

**Heat dissipations for lamp starters**

Lamp circuit breaker	Connection type*	Lamp contactor	Busbar adapter	Combination heat dissipation
MS132-20L	6 mm <sup>2</sup> cable	AF16...-L	no	< 3 W per pole
MS132-20L	6 mm <sup>2</sup> cable	AF26...-L	no	< 4 W per pole
MS132-20L	6 mm <sup>2</sup> cable	AF16...-L	yes	< 5.5 W per pole
MS132-20L	6 mm <sup>2</sup> cable	AF26...-L	yes	< 6 W per pole

\*connection between lamp circuit breaker and lamp contactor

**Principle connection of lamp fixtures to supply**

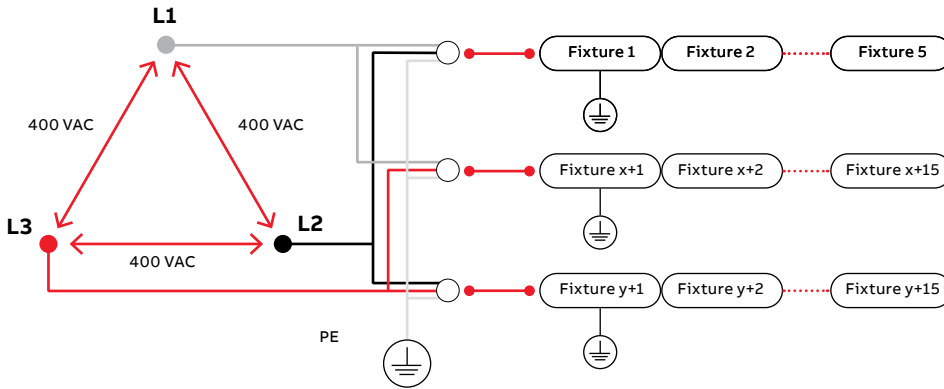

09 Fixture wiring configuration

**Non-tripping current of lamp circuit breakers**

The selection of the suitable lamp circuit breaker requires to identify the maximum inrush current per phase of all lamp loads in order to check if the tripping current of the breaker is higher than the resulting inrush current.

This inrush current is highly influenced by the design of the lamp starting electronics. Exceeding the non tripping current will result in an unwanted tripping of the lamp circuit breaker.

Typically these characteristic data will be provided in the data sheet of the fixture.

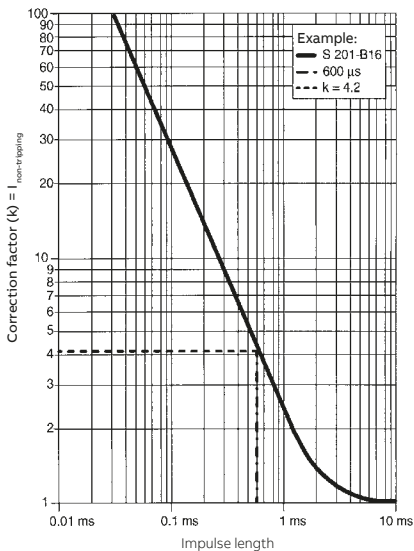

Example: Non-tripping current (electromagnetic release)

S 201-B16  
 $I_{non-tripping} = k \times \text{non-tripping current}$   
 $I_{non-tripping} = 4.2 \times 3 \times 16$   
 $I_{non-tripping} = 201.6 \text{ A}$

Valid for all electromechanical protection devices

- B characteristic = 3 x  $I_n$
- C characteristic = 5 x  $I_n$
- D characteristic = 10 x  $I_n$
- K characteristic = 10 x  $I_n$
- Z characteristic = 2 x  $I_n$
- MS132-xL = 12 x  $I_n$
- MS132-xLC = 6 x  $I_n$

The S201-B16 does not trip at an impulse of 600 μs at a current up to 201.6 A

10 Example of a non-tripping energy curve (also valid for lamp circuit breakers)

**Following example may be used as a guidance for a Lamp Starter Evaluation**

**Input Data:**

Lamp 1000 W / 400 V AC – 2.61 A  
 Inrush current per fixture 60 A / 1000 micro sec  
 Power factor 0.95

**Recommendations:**

Lamps connected between phases

Number of lamps always equal to three (symmetrically loaded)

Phase current should not exceed 70% of lamp circuit breaker rating

**Step 1 – Evaluation of phase current with assumed number of lamps per lamp starter**

Selection of MS132-20L as starting point

70% rule applied to MS132-20L results in 14 A

Calculate resulting power with assumed number of lamps = lamp power \* number of lamps

Assumption: 9 lamps

Resulting power = 9 kW

Phase current = resulting power /  $\sqrt{3}$  \* power factor \* rated voltage =  $9000 \text{ W} / \sqrt{3} * 0.95 * 400 \text{ V} = 13.69 \text{ A}$ .

**Step 2 – Evaluation of Inrush current per phase**

Inrush current = number of lamps per phase \* inrush current per fixture (from data sheet)

Inrush current =  $3 * 60 \text{ A} = 180 \text{ A}$ .

**Step 3 – Evaluation of Non-Tripping at lamp start**

Non tripping current of MS132-20L = k factor (see figure 10, value for 1000 micro sec) \* 12 (lower level magnetic tripping) \* In

Non tripping current =  $2.2 * 12 * 20 \text{ A} = 528 \text{ A}$

Result: MS132-20L will not trip as total inrush current of lamp (180 A, as calculated in step 2) is lower than the non-tripping current of the MS132-20L.

**Step 4**

Check if lamp contactor is matching with the phase current as calculated in step 1.

Refer to data sheet of lamp contactor.

**Step 5**

Check if the lamp contactor is able to withstand the total inrush current/impulse duration (per Phase) as calculated in step 2.

Refer to data sheet of lamp contactor.

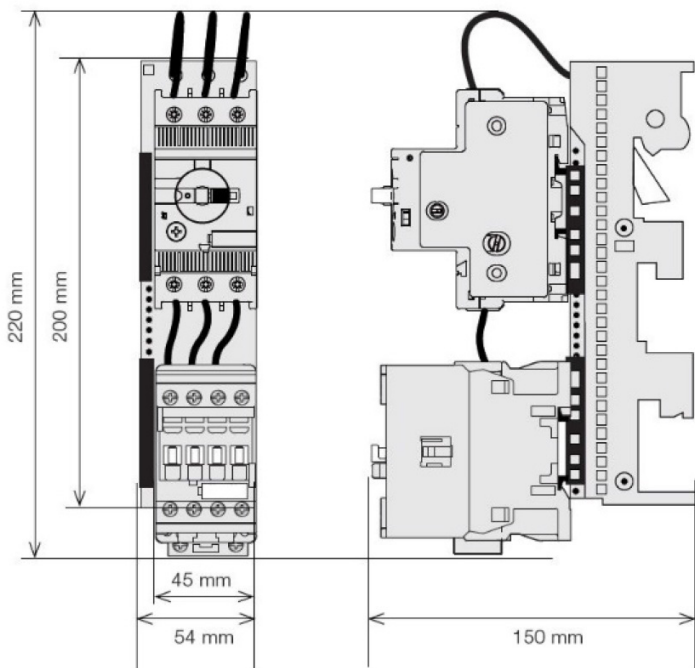
**Dimensions in mm**

Example wiring diagram

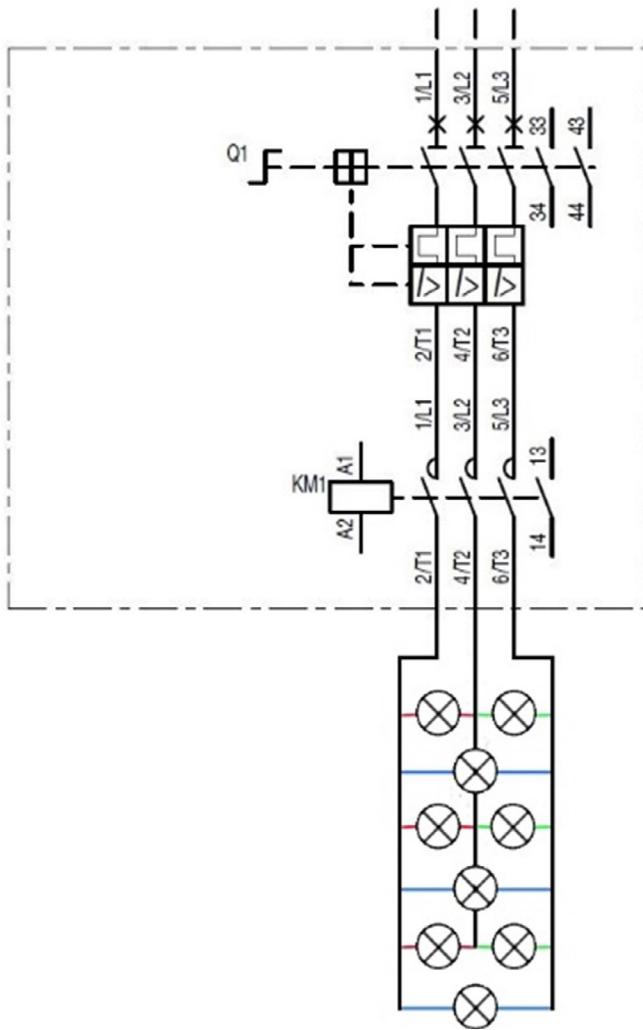









12 Lamp starter in power circuit with lamp loads

## 6 Technical data

### 6.1 Lamp circuit breakers

- For other characteristics, please consult your ABB sales representative
- Accessory fitting details: same as standard MS132 manual motor starters

Type		MS132-16L	MS132-20L	MS132-25L
Standards		IEC/EN 60947-1, IEC/EN 60947-2, IEC/EN 60947-4-1		
Rated operational voltage U <sub>e</sub>		690 V AC		
Rated frequency		50/60 Hz		
Rated impulse withstand voltage U <sub>imp</sub>		6 kV		
Rated insulation voltage U <sub>i</sub>		690 V		
Setting range	lower range	10.0 A	16.0 A	20.0 A
	upper value	16.0 A	20.0 A	25.0 A
Rated instantaneous short-circuit current setting I <sub>i</sub>		240 A	300 A	375 A
Resistance per pole		0.011 Ω	0.0057 Ω	0.0045 Ω
Power loss per pole	at lower value	1.1 W	1.5 W	1.8 W
	at upper value	2.8 W	2.3 W	2.8 W
Pollution category		3		
Overvoltage category acc. to IEC/EN 60664		up to III		
Protective separation acc. to IEC/EN 61140 between the conducting paths of the main circuit		No		
Ambient air temperature				
Operation	open compensated	-25...+60 °C		
Storage	open compensated	-50...+80 °C		
Ambient air temperature compensation		acc. to IEC/EN 60947-4-1		
Maximum operating altitude permissible		2000 m		
Mounting position		Position 1-6 (optional for single mounting)		
Degree of protection	housing	IP20		
	main circuit terminals	IP10		
Connecting Capacity, min. / max.				
 rigid	1 or 2x	1...2.5 mm <sup>2</sup>		
		2.5...6 mm <sup>2</sup>		
 flexible with ferrule	1 or 2x	0.75...6 mm <sup>2</sup>		
 flexible with insulated ferrule	1 or 2x	0.75...6 mm <sup>2</sup>		
 flexible	1 or 2x	1.5...2.5 mm <sup>2</sup>		
		2.5...6 mm <sup>2</sup>		
Stripping length		10 mm		
Tightening torque		2.0 Nm		
Connection screw		M4		
Recommended screw driver		Pozidriv 2 / 6.5 mm		
Minimum distance to other units same type	horizontal	0 mm		
	vertical	150 mm		
Minimum distance to electrical conductive board	horizontal, up to 400 V	0 mm		
	horizontal, up to 690 V	> 1.5 mm		
	vertical	75 mm		

Type		MS132-10LC	MS132-16LC	MS132-20LC
Standards		IEC/EN 60947-1, IEC/EN 60947-2		
Rated operational voltage Ue		400 V AC		
Rated frequency		50/60 Hz		
Rated impulse withstand voltage Uimp		6 kV		
Rated insulation voltage Ui		690 V		
Setting range	lower range	6.3 A	10 A	16 A
	upper value	10 A	16 A	20 A
Rated instantaneous short-circuit current setting Ii		75 A	120 A	150 A
Resistance per pole		0.020 Ω	0.011 Ω	0.0057 Ω
Power loss per pole	at lower value	0.8 W	1.1 W	1.5 W
	at upper value	2.0 W	2.8 W	2.3 W
Pollution category		3		
Overvoltage category acc. to IEC/EN 60664		up to III		
Protective separation acc. to IEC/EN 61140 between the conducting paths of the main circuit		No		
Ambient air temperature				
Operation	compensated without derating	-25...+60 °C		
Operation	Open, derating above 60°C according to data sheet	-25...+70 °C		
Storage		-50...+80 °C		
Ambient air temperature compensation		yes		
Maximum operating altitude permissible		2000 m		
Mounting position		Position 1-6 (optional for single mounting)		
Degree of protection	housing	IP20		
	main circuit terminals	IP10		
Connecting Capacity, min. / max.				
 rigid	1 or 2x	1 ... 4 mm <sup>2</sup>	1 ... 2.5 mm <sup>2</sup>	1 ... 2.5 mm <sup>2</sup>
			2.5 ... 6 mm <sup>2</sup>	2.5 ... 6 mm <sup>2</sup>
 flexible with ferrule	1 or 2x	0.75 ... 2.5 mm <sup>2</sup>	0.75 ... 6 mm <sup>2</sup>	0.75 ... 6 mm <sup>2</sup>
 flexible with insulated ferrule	1 or 2x	0.75 ... 2.5 mm <sup>2</sup>	0.75 ... 6 mm <sup>2</sup>	0.75 ... 6 mm <sup>2</sup>
 flexible	1 or 2x	0.75 ... 2.5 mm <sup>2</sup>	1.5 ... 2.5 mm <sup>2</sup>	1.5 ... 2.5 mm <sup>2</sup>
			2.5 ... 6 mm <sup>2</sup>	2.5 ... 6 mm <sup>2</sup>
Stripping length		9 mm	10 mm	10 mm
Tightening torque		0.8 ... 1.2 Nm	2 Nm	2 Nm
Connection screw		M3.5	M4	M4
Recommended screw driver		Pozidriv 2 / 5.5 mm	Pozidriv 2 / 6.5 mm	Pozidriv 2 / 6.5 mm
Minimum distance to other units same type	horizontal	0 mm		
	vertical	150 mm		
Minimum distance to electrical conductive board	horizontal, up to 400 V	0 mm		
	vertical	75 mm		

## Breaking Capacities

### Type MS132-L 400 V AC

	Ics [kA]	Icu [kA]
16 A	100	100
20 A	100	100
25 A	50	50

### Type MS132-LC 400 V AC

	Ics [kA]	Icu [kA]
10 A	50	50
16 A	50	50
20 A	50	50



**Dimensions in mm, inches**

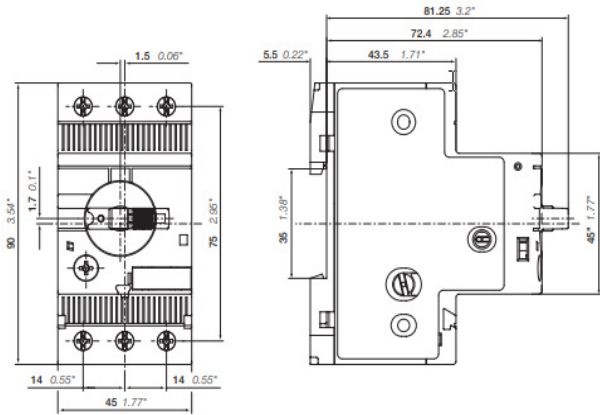

13 MS132-L, MS132-LC (16 A, 20 A, and 25 A)

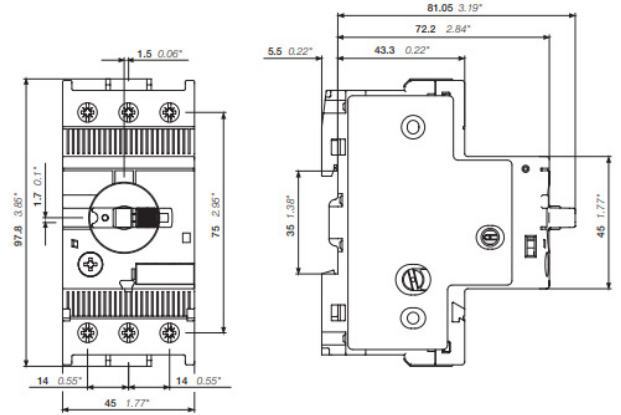

14 MS132-10LC



**6.2 Lamp contactors**

- For other characteristics, please consult your ABB sales representative
- Accessory fitting details: same as standard AF16 and AF26 contactors

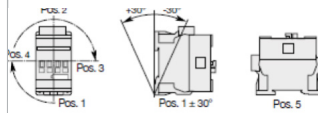
Type	AF16-40-00L	AF26-30-00L
Standards	IEC 60947-1 / 60947-4-1 and EN 60947-1 / 60947-4-1	
Rated operational voltage U <sub>e</sub>	690 V AC	
Rated frequency	50/60 Hz	
Conventional free-air thermal current I <sub>th</sub>		
acc. to IEC 60947-4-1, open contactors, θ ≤ 40 °C	35 A	50 A
Lamp currents	16 A	26 A
Max. Inrush current / impulse duration	500 A / 300 μsec	1850 A / 300 μsec
	440 A / 5000 μsec	1150 A / 5000 μsec
	400 A / 8000 μsec	945 A / 8000 μsec
	360 A / 10000 μsec	875 A / 10000 μsec
with conductor cross-sectional area	6 mm <sup>2</sup>	10 mm <sup>2</sup>
Max. electrical switching frequency	6 mm <sup>2</sup>	10 mm <sup>2</sup>
Rated insulation voltage U <sub>i</sub> acc. to IEC 60947-4-1	690 V	
Rated impulse withstand voltage U <sub>imp</sub>	6 kV	
Power loss per pole	0.35 W	0.6 W
Electromagnetic compatibility	Devices complying with IEC 60947-1 / EN 60947-1 - Environment A and B	
Ambient air temperature close to contactor		
Operation	fitted with thermal overload relay	-25...+60 °C
	without thermal overload relay	-40...+70 °C
Storage	-60...+80 °C	
Climatic withstand	Category B according to IEC 60947-1 Annex Q	
Maximum operating altitude (without derating)	3000 m	
Coil operating limits acc. to IEC 60947-4-1		
AC supply	At θ ≤ 60 °C 0.85 x U <sub>c</sub> min...1.1 x U <sub>c</sub> max.	
	At θ ≤ 70 °C 0.85 x U <sub>c</sub> min...U <sub>c</sub> max.	
DC supply	At θ ≤ 60 °C 0.85 x U <sub>c</sub> min...1.1 x U <sub>c</sub> max.	
	At θ ≤ 70 °C (AF) 0.85 x U <sub>c</sub> min...U <sub>c</sub> max.	
AC control voltage 50/60 Hz		
Rated control circuit voltage U <sub>c</sub>	100...500 V AC/DC	
Coil consumption	average pull-in value	50 VA
	average holding value	2.2 VA / 2 W

Drop-out voltage		≤ 60 % of Uc min.
Operating time		
Between coil energization and:	N.O. contact closing	40...95 ms
	N.C. contact opening	38...90 ms
Between coil de-energization and:	N.O. contact opening	11...95 ms
	N.C. contact closing	13...98 ms
Mounting position		 <p>Max. N.C. built-in and add-on N.C. auxiliary contacts: see accessory fitting details for</p> <p>4-pole contactor AF16      3-pole contactor AF26</p>

**AF16-40-00L, AF26-30-00L electromagnetic compatibility:**  
 Devices comply with IEC 60947-1 / EN 60947-1 - Environment A and B  
 Electrical fast transient burst immunity test acc. to IEC 61000-4-4  
 On coil power supply: 2 kV, 5 KHz  
 Surge immunity test acc. to IEC 61000-4-5 1.2 / 50 μs  
 2 kV (line to earth)  
 1 kV (line to line)

Type		AF16-40-00L	AF26-30-00L	
Connection capacity (min. ... max.)				
Main conductors (poles)				
	rigid	Solid (≤ 4 mm <sup>2</sup> )	1 x 1...6 mm <sup>2</sup>	2.5...10 mm <sup>2</sup>
		Stranded (≥ 6 mm <sup>2</sup> )	2 x 1...6 mm <sup>2</sup>	2.5...10 mm <sup>2</sup>
	flexible with non-insulated ferrule		1 x 0.75...6 mm <sup>2</sup>	1.5...10 mm <sup>2</sup>
			2 x 0.75...6 mm <sup>2</sup>	1.5...10 mm <sup>2</sup>
	flexible with insulated ferrule		1 x 0.75...4 mm <sup>2</sup>	1.5...10 mm <sup>2</sup>
			2 x 0.75...2.5 mm <sup>2</sup>	1.5...4 mm <sup>2</sup>
Stripping length		10 mm	14 mm	
Tightening torque	main circuit terminals	1.5 Nm	2.5 Nm	
	coil terminals	1.2 Nm		
Degree of protection	main and coil terminals	IP20		
Screw terminals	main circuit terminals	M3.5	M4	
	coil terminals	M3.5		
Recommended screwdriver	main circuit terminals	Flat Ø 5.5 / Pozidriv 2	Flat Ø 6.5 / Pozidriv 2	
	coil terminals	Flat Ø 5.5 / Pozidriv 2		

**Dimensions in mm**

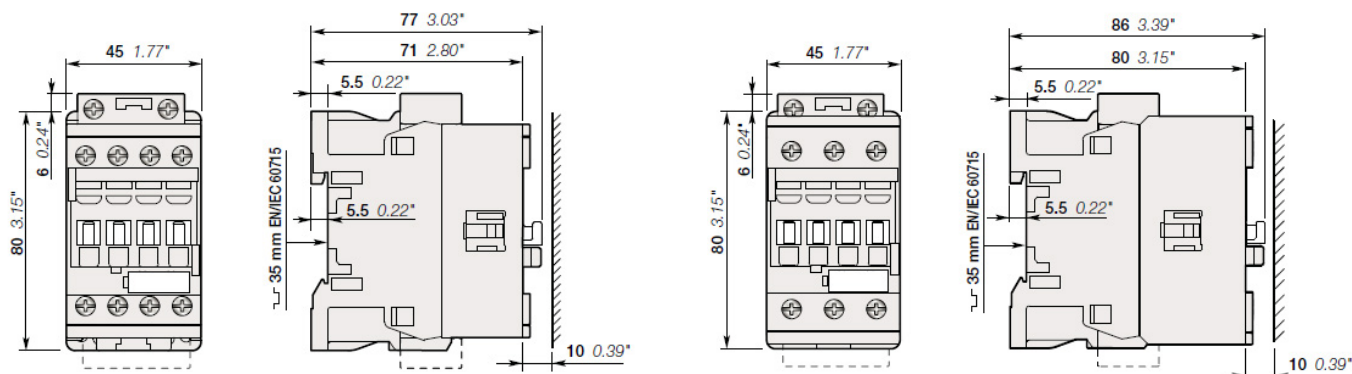

### 6.3 OT disconnect switch

Three-pole, front-operated, base-mounted switch-disconnector with black IP65 handle and shaft, wide phase distance and a terminal bolt kit included.

Type: OT315E03WP



17 OT315E03WP disconnect switch

Dimensions	
Product net dimensions (W x H x D)	191 x 185 x 107 mm
Product net weight	3.38 kg
Technical information	
Rated operational current AC-21A ( $I_e$ )	(380 ... 415 V) 315 A (500 V) 315 A (690 V) 315 A (1000 V) 315 A
Rated operational current AC-22A ( $I_e$ )	(380 ... 415 V) 315 A (500 V) 315 A (690 V) 315 A
Rated operational current AC-23A ( $I_e$ )	(500 V) 315 A (380 ... 415 V) 315 A (690 V) 315 A
Rated operational power AC-23A ( $P_e$ )	(380 ... 415 V) 160 kW (500 V) 220 kW (690 V) 315 kW
Conventional free-air thermal current ( $I_{th}$ )	q = 40 °C 315 A
Conventional thermal current ( $I_{the}$ )	fully enclosed 315 A
Rated impulse withstand voltage ( $U_{imp}$ )	12 kV
Rated insulation voltage ( $U_i$ )	1000 V
Rated operational voltage	1000 V
Rated short-circuit making capacity ( $I_{cm}$ )	(690 V AC) 65 kA
Rated short-time withstand current ( $I_{cw}$ )	for 1 s 15 kiloampere rms
Power loss	at rated operating conditions per pole 6.5 W
Pollution degree	3
Handle type	handle and shaft included
Switches operating mechanism	mechanism at the end of the switch
Distance between phases	wide phase distance
Position of line terminals	top in - bottom out
Operating mode	front operated
Standards	IEC 60947-3
Special functions	wide phase distance
Mounting type	base mounting
Number of poles	3
Terminal type	lug terminals
Terminal width	25 mm
Tightening torque	30...44 Nm

#### 6.4 MCCB Tmax XT, 250 A with residual current device

The European standard EN/IEC60364-7-705 (electrical installations of agricultural and horticultural premises) requires the usage of residual current devices (RCDs) with 300 mA. This may be mandatory in certain countries and has to be implemented in a suitable design. For example, in the Netherlands the standard NEN1010:2015 art 705.411.1 requires the use of RCDs in the segment agriculture, horticulture and livestock farming. For this, ABB's Tmax XT4N 250 with residual current device RC Sel x XT4 4p can be used. For assimilation panels it is according to (EN/IEC60364-7-705) allowed, that all end groups can be protected by a group protection device, as long as the sum of the leakage currents does not exceed 30 percent of the assigned trip current.



18 Tmax XT4N 250 4p FF

Link to ABB MCCB catalog:

<https://new.abb.com/low-voltage/products/circuit-breakers>

#### Technical information

Rated uninterrupted current, I <sub>u</sub>		160/250 A
Rated current (Thermo-Magnetic trip unit), I <sub>n</sub>		16...250 A
Rated current (Electronic Ekip Dip trip unit), I <sub>n</sub>		40...250 A
Rated current (Electronic Ekip Touch trip unit), I <sub>n</sub>		100...250 A
Poles	[No.]	3/4
Category		A
Rated voltage, U <sub>e</sub>	(AC) 50-60 Hz	220/240, 380/415, 440, 500, 525, 690 V
Rated voltage, U <sub>e</sub>	(DC)	250, 500 V
Rated impulse withstand voltage, U <sub>imp</sub>		8 kV
Rated insulation voltage U <sub>i</sub>		1000 V
Test voltage at industrial frequency for 1 minute		3000 V
Rated ultimate short-circuit breaking capacity, I <sub>cs</sub>		65kA at 220/240 36kA at 380/415, 440, 30kA at 500 20kA at 525 10kA 690 V
Rated service short-circuit breaking capacity, I <sub>cs</sub>		65kA at 220/240 36kA at 380/415, 440, 30kA at 500 20kA at 525 10kA 690 V
Rated short-circuit making capacity, I <sub>cm</sub>		143kA at 220/240 75.6kA at 380/415, 440, 63kA at 500 40kA at 525 17kA 690 V
Power loss (XT4N 250 4p FF)		16.4 W
Reference Standard		IEC60947-2

Additional marks (*upon request)			CE, UKCA, CMiM, CCC*, KC*, VPC*, RETIE*, SASO*
Versions			F – P – W
Terminals			F-FC CuAl-FC Cu-EF-ES-R-MC-HR-VR
Mechanical life			25000 no. operations 240 no. hourly operations
Basic dimensions, fixed	3 poles	W	105 mm
	4 poles	W	140 mm
		D	82.5 mm
		H	160 mm
Weight	Fixed	3/4 poles	2.35/3.05 kg
	Plug-in	3/4 poles	4.2/5.52 kg
	Withdrawable	3/4 poles	5.0/6.76 kg

Protection	Settings	EKIP DIP LIG	EKIP DIP L SI	EKIP DIP L SIG	EKIP Touch L SI EKIP Touch Measuring L SI EKIP Hi-Touch L SI	EKIP Touch L SIG EKIP Touch Measuring L SIG EKIP Hi-Touch L SIG
Overload (Phase, neutral)	Current	0.4 / 1 x I <sub>n</sub>	0.4 / 1 x I <sub>n</sub>	0.4 / 1 x I <sub>n</sub>	0.4 / 1 x I <sub>n</sub>	0.4 / 1 x I <sub>n</sub>
	tolerance	between 1.05 / 1.3 x I <sub>l</sub>	between 1.05 / 1.3 x I <sub>l</sub>	between 1.05 / 1.3 x I <sub>l</sub>	between 1.05 / 1.3 x I <sub>l</sub>	between 1.05 / 1.3 x I <sub>l</sub>
	Time	12 / 36 s	3 / 60 s	3 / 60 s	3 / 144 s	3 / 144 s
	tolerance	≤ 4 x I <sub>n</sub> ±10%; > 4 x I <sub>n</sub> ±20%	≤ 4 x I <sub>n</sub> ±10%; > 4 x I <sub>n</sub> ±20%	≤ 4 x I <sub>n</sub> ±10%; > 4 x I <sub>n</sub> ±20%	≤ 6 x I <sub>n</sub> ±10%; > 6 x I <sub>n</sub> ±20%	≤ 6 x I <sub>n</sub> ±10%; > 6 x I <sub>n</sub> ±20%
Selective (Phase, neutral)	Current	Not applicable	1 / 10 x I <sub>n</sub>	1 / 10 x I <sub>n</sub>	0.6 / 10 x I <sub>n</sub>	0.6 / 10 x I <sub>n</sub>
	tolerance		± 10%	± 10%	± 7%	± 7%
	Time		0.05 / 0.4 s	0.05 / 0.4 s	0.05 / 0.4 s	0.05 / 0.4 s
	tolerance		≤ 4 x I <sub>n</sub> ±10%; > 4 x I <sub>n</sub> ±20%	≤ 4 x I <sub>n</sub> ±10%; > 4 x I <sub>n</sub> ±20%	≤ 6 x I <sub>n</sub> ±15%; > 6 x I <sub>n</sub> ± 10%	≤ 6 x I <sub>n</sub> ±15%; > 6 x I <sub>n</sub> ± 10%
Instantaneous (Phase, neutral)	Current	1 / 10 x I <sub>n</sub>	1 / 10 x I <sub>n</sub>	1 / 10 x I <sub>n</sub>	1.5 / 10 x I <sub>n</sub>	1.5 / 10 x I <sub>n</sub>
	tolerance	±10%	±10%	±10%	±10%	±10%
	Time	≤ 60 ms	≤ 60 ms	≤ 60 ms	≤ 60 ms	≤ 60 ms
Earth fault * (Phase, neutral)	Current	0.2 / 1 x I <sub>n</sub>	Not applicable	0.2 / 1 x I <sub>n</sub>	Not applicable	0.1 / 1 x I <sub>n</sub>
	tolerance	±10%		±10%		±7%
	Time	0.1 / 0.8 s		0.1 / 0.8 s		0.1 / 1 s
	tolerance	±20%		±20%		±10% or ≤ 40 ms

\* only for EKIP DIP LIG / EKIP DP L SIG

**Dimensions OT315E03WP in mm**

OT315_ ... OT400_				
mm	E01	E02	E03	E04
A	103	147	191	235
B	-	44	44	44
A1	140	140	140	140
A2	78	122	166	210
B1	135	135	135	135
B2	96	140	184	228
C1	104	104	104	104
C2	114	158	202	246

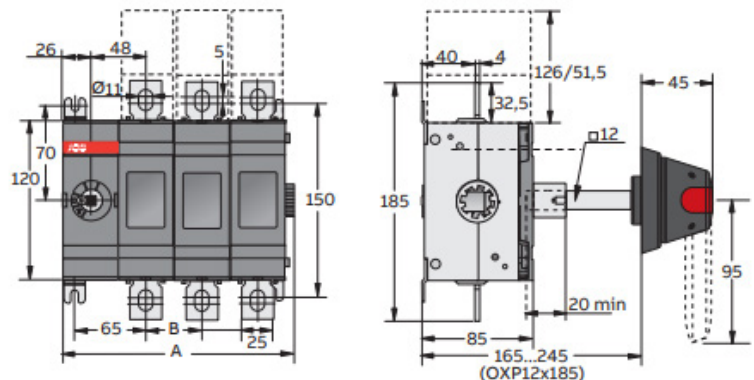

19 Dimension drawing OT315E03WP

**Dimensions Tmax XT4N and RC Sel x XT4 in mm**

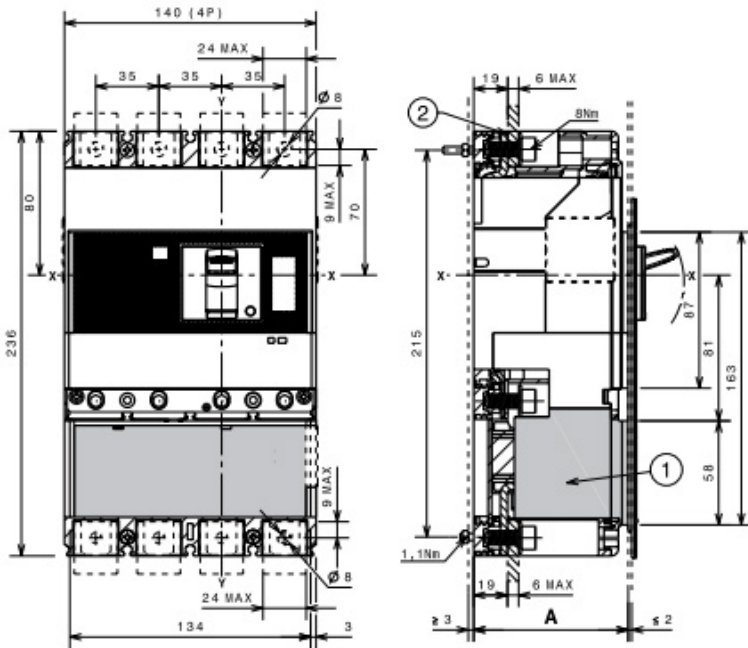

20 Dimensions Tmax XT4N and RC Sel x XT4

**6.5 Busbar adapter**

The busbar adapters are optionally used to connect the lamp starters to a 60 mm busbar distribution system, which allows an easy, safe and fast mounting of various components (e.g. lamp circuit breakers and contactors) without drilling the busbars. It is sufficient to snap them on the busbar system. Adapter 32 A with two adjustable mounting rails.

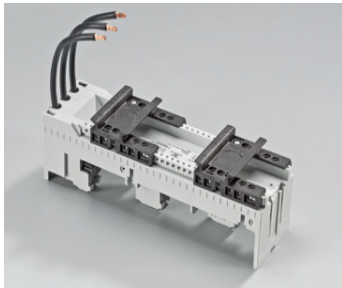

21 Adapter 32 A

Technical information	
Product net dimensions (W x H x D)	54 x 200 x 63 mm
Weight	0.38 kg
Rated current	32 A
Rated voltage	690 V AC
Short-circuit capacity (adapter and lamp circuit breaker)	depends on lamp circuit breaker
Rated isolation voltage Ui	800 V AC
Rated impulse withstand voltage Uimp	6 kV
Cable cross section	6 mm <sup>2</sup> (AWG 10)
Poles	3
Power loss at 80 % rated current	1.5 W
Power loss at 100 % rated current	2.4 W
Max operating current (UL)	30 A
Max operating voltage (UL)	600 V AC
Standards	IEC 61439-1
Suitable for busbars	12, 15, 20, 25, 30 x 5, 10 and section busbars

Material properties	
Body	temperature stability 125 °C
	self-extinguishing acc. to UL 94
	creepage resistance CTI 600
	halogen-free
DIN rail	temperature stability 125 °C
	self-extinguishing acc. to UL 94
	creepage resistance CTI 550
	halogen-free
Screws	screw +/- (PZ1), galvanized, chromized
Conductor insulation	temperature-resistant up to 105 °C

### Dimensions in mm

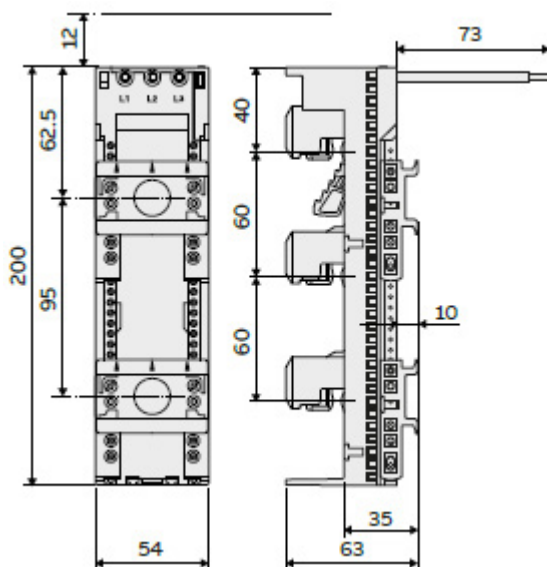

22 Dimensions busbar adapter

### Additional information about the busbar system

Tin-plated copper busbars make contact position preparation much easier. Copper busbars are effectively protected against corrosive substances. The current capacities of flat busbars in the diagram below were calculated by testing at an ambient temperature of 35 °C under ideal conditions (IEC and UL).

Current carrying capacities higher than those specified in DIN 43671 were obtained under operating conditions. The busbar temperature is normally positively influenced by mounting components on the busbar and by air circulation within the installation.

A correction factor  $k_2$  as defined in DIN 43671 can be applied for flat busbars using the diagram below. The factor is dependent on the relevant ambient temperature. This correction factor should be taken into account when conditions change and loading is continuous. Alternatively, a higher load can be applied if the components have a higher thermal endurance level. A 30 x 10 galvanized busbar can, under normal operating conditions, be loaded with 630 A. A correction factor  $k_2$  of 1.3, for example, is required if a load of 800 A is applied. This diagram demonstrates that the busbar heats up to approx. 85 °C if this correction factor and an air temperature of 35 °C apply.

- Tensile strength: min. 300 N/mm<sup>2</sup>
- Permissible tolerance
  - Radius R 0.3...0.7
  - Width: +0.1 / -0.5
  - Thickness: +0.1 / -0.1
- Centre spacing:
  - +0.5 / -0.5 (60 mm system)
  - +1.0 / -1.0 (100 mm system / 185 mm system)
- Deviation in the contact levels: 0.4

### Correction factor diagram according to DIN 43671

The diagram below is taken from DIN 43671. It shows the correction factor  $k_2$  (used to correct the basic rated current) depending on the busbar temperature and the ambient temperature in °C.

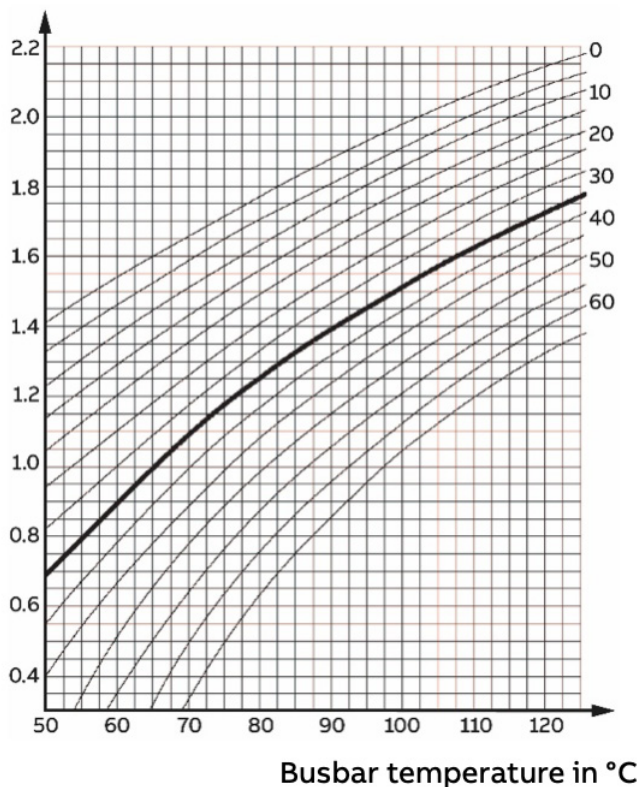



**Continuous currents for busbars according to DIN 43671**

Width x thickness [mm]	Cross section [mm <sup>2</sup> ]	Weight [kg] <sup>(1)</sup>	Material <sup>(2)</sup>	Continuous x current [A] AC current up to 60 Hz	
				Bare bar	Coated bar
12 x 2	23.5	0.209	E-Cu F30	108	123
15 x 2	29.5	0.262		128	148
15 x 3	44.5	0.396		162	187
20 x 2	39.5	0.351		162	189
20 x 3	59.5	0.529		204	237
20 x 5	99.1	0.882		274	319
20 x 10	199.0	1.770		427	497
25 x 3	74.5	0.663		245	287
25 x 5	124.0	1.110		327	384
30 x 3	89.5	0.796		285	337
30 x 5	149.0	1.330		379	447
30 x 10	299.0	2.660		573	676
40 x 3	119.0	1.060		366	435
40 x 5	199.0	1.770		482	573
40 x 10	399.0	3.550		715	850
50 x 5	249.0	2.220		583	697
50 x 10	499.0	4.440		852	1020
60 x 5	299.0	2.660		688	826
60 x 10	599.0	5.330		985	1180
80 x 5	399.0	3.550		885	1070
80 x 10	799.0	7.110		1240	1500
100 x 10	999.0	8.890		1490	1810

(1) Calculated with a density of 8.9 kg/dm<sup>3</sup>

(2) Reference basis for the continuous current levels (figures taken from DIN 43 671)

## 7 Normative references

The following documents are referred to in the text in such a way that some or all of their content may constitute requirements. For dated references, only the edition cited applies. For undated references, the latest edition of the referenced document (including any amendments) applies.

- IEC 60947-1 (edition 6)  
Low-voltage switchgear and controlgear - Part 1: General rules
- IEC 60947-2 (edition 5.1)  
Low-voltage switchgear and controlgear - Part 2: Circuit-breakers
- IEC 60947-4-1 (edition 4)  
Low-voltage switchgear and controlgear - Part 4-1: Contactors and motor-starters
- IEC 61439-1 (edition 3.0)  
Low-voltage switchgear and controlgear assemblies - Part 1: General rules
- IEC 61439-2 (edition 3.0)  
Low-voltage switchgear and controlgear assemblies - Part 2: Power switchgear and controlgear assemblies
- IEC 60364-7-705 (edition 2)  
Low-voltage electrical installations - Part 7-705: Requirements for special installations or locations - Agricultural and horticultural premises
- IEC 60598-1 (edition 9.0)  
Luminaires - Part 1: General requirements and tests
- IEC TR 60890 (edition 1)  
A method of temperature-rise verification of low-voltage switchgear and controlgear assemblies by calculation
- DIN 43671 (edition 1975-12)  
Copper busbars; design for continuous current

—  
**ABB France**  
**Electrification Business**  
**Low Voltage Products and Systems**  
2 rue d'Arsonval  
F-69687 Chassieu cedex / France

—  
**ABB STOTZ-KONTAKT GmbH**  
Eppelheimer Strasse 82  
69123 Heidelberg, Germany

**You can find the address of your local  
sales organization on the ABB homepage**

**[abb.com/lowvoltage](http://abb.com/lowvoltage)**



**Additional information**

We reserve the right to make technical changes or modify the contents of this document without prior notice. With regard to purchase orders, the agreed particulars shall prevail. ABB AG does not accept any responsibility whatsoever for potential errors or possible lack of information in this document.

We reserve all rights in this document and in the subject matter and illustrations contained therein. Any reproduction, disclosure to third parties or utilization of its contents – in whole or in parts – is forbidden without prior written consent of ABB AG.  
Copyright© 2023 ABB  
All rights reserved