

—  
INSTALLATION INSTRUCTION

# Enclosed Switch Fuses

## OS200-630

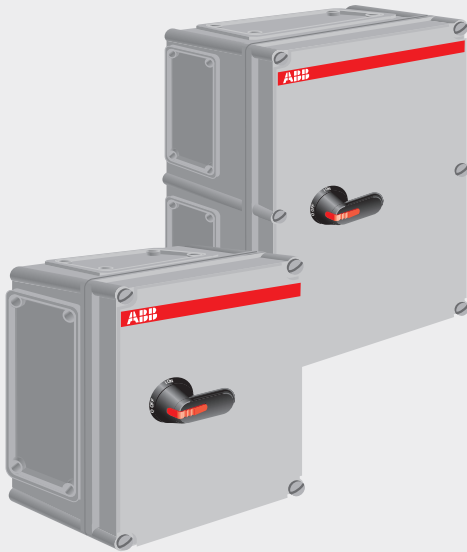

# Different types of enclosed switch fuses, main circuits

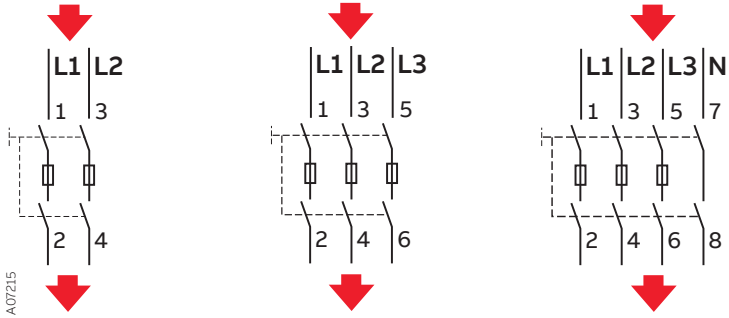

## Enclosure dimensions and fixing







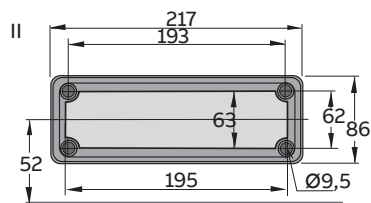
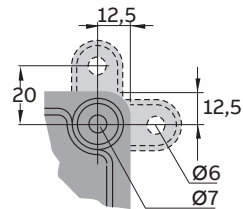
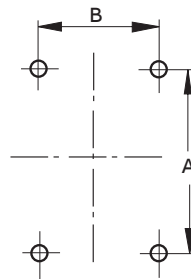
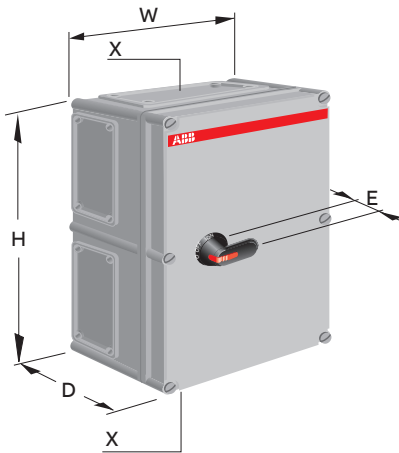



[mm]

	H	W	D	E	A	B	X
380 x 280 x 130	380	280	130	45	355	255	II
560 x 280 x 180	560	280	180	45	535	255	II
560 x 380 x 180	560	380	180	45	535	355	II
560 x 380 x 280	560	380	280	45	535	355	II
760 x 560 x 250	760	560	250	45	735	535	2 x II

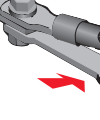

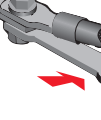
# Tightening torques of connectors

[Nm] 			
PE	Q	N	 Fuse
 6 Nm   30 Nm	 M8 15...22 Nm  M10 30...44 Nm  M12 50...75 Nm	 M8 15...22 Nm  M10 30...44 Nm  M12 50...75 Nm	OS200B_   4 OS315B_   20 OS400B_   20 OS630B_   30 OS800B_   30

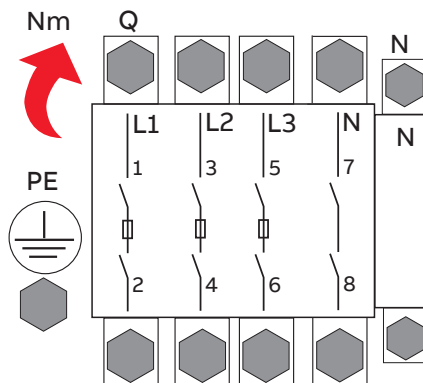

## Handle padlocking and bypass locking in ON-position

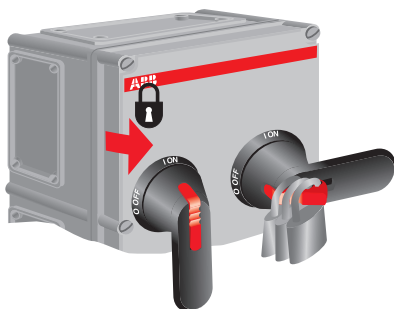

Ø5...10 mm

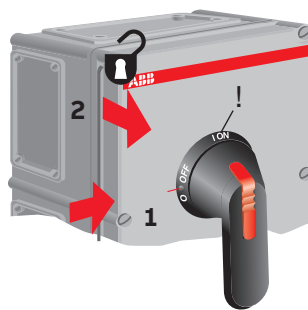
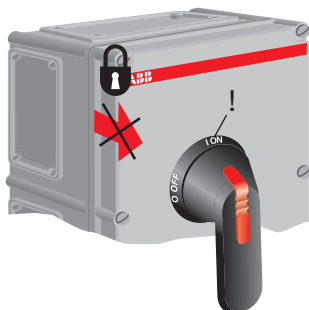
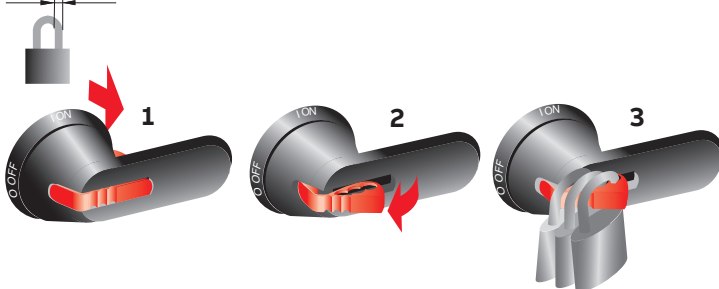





<b>BG</b>	Внимание! Опасно напряжение! Да се монтира само от лице с електротехническа квалификация.
<b>CN</b>	警告！电压危险！只能由专业电工进行安装。
<b>CZ</b>	Varování! Nebezpečné napětí! Montáž smí provádět výhradně elektrotechnik!
<b>DA</b>	Advarsel! Farlig elektrisk spænding! Installation må kun foretages af personer med elektroteknisk ekspertise.
<b>DE</b>	Warnung! Gefährliche Spannung! Installation nur durch elektrotechnische Fachkraft.
<b>EL</b>	Προειδοποίηση! Υψηλή τάση! Η εγκατάσταση πρέπει να γίνεται μόνο από εξειδικευμένους ηλεκτροτεχνικούς.
<b>EN</b>	Warning! Hazardous voltage! Installation by person with electrotechnical expertise only.
<b>ES</b>	¡Advertencia! ¡Tensión peligrosa! La instalación deberá ser realizada únicamente por electricistas especializados.
<b>ET</b>	Hoiatus! Ohtlik pinge. Paigaldada võib ainult elektrotehnika-alane ekspert.
<b>FI</b>	Varoitus! Vaarallinen jännite! Asennuksen voi tehdä vain sähköalan ammattihenkilö.
<b>FR</b>	Avertissement! Tension électrique dangereuse! Installation uniquement par des personnes qualifiées en électrotechnique.
<b>HR</b>	Upozorenje! Opasan napon! Postavljati smije samo elektrotehnički stručnjak.
<b>HU</b>	Démesio! Pavojinga įtampa! Dirbti leidžiama tik elektrotechniko patirties turintiems asmenims.
<b>IE</b>	Rabhadh! Voltas guaiseach! Ba chóir do dhuine ag a bhfuil saineolas leictriteicniúil, agus an té sin amháin, é seo a shuiteáil.
<b>IT</b>	Avvertenza! Tensione pericolosa! Fare installare solo da un elettricista qualificato.
<b>LT</b>	Dėmesio! Pavojinga įtampa! Dirbti leidžiama tik elektrotechniko patirties turintiems asmenims.
<b>LV</b>	Uzmanību! Bīstami - elektrība! Montāžas darbus drīkst veikt tikai personas, kurām ir atbilstošas elektrotehniskās zināšanas.
<b>MT</b>	Twissija! Vultaġġ perikolużi! Għandu jiġi installat biss minn persuna b'kompetenza elettroteknika.
<b>NL</b>	Waarschuwing! Gevaarlijke spanning! Mag alleen geïnstalleerd worden door een deskundige elektrotechnicus.
<b>NO</b>	Advarsel! Farlig spenning! Montering skal kun utføres av kvalifiserte personer med elektrokompetanse.
<b>PL</b>	Ostrzeżenie! Niebezpieczne napięcie! Instalacji może dokonać wyłącznie osoba z fachową wiedzą w dziedzinie elektrotechniki.
<b>PT</b>	Aviso! Tensão perigosa! A instalação só deve ser realizada por um electricista especializado.
<b>RO</b>	Avvertizare! Tensiune periculoasă! Instalarea trebuie efectuată numai de către o persoană cu experiență în electrotehnica.
<b>RU</b>	Осторожно! Опасное напряжение! Монтаж должен выполняться только специалистом-электриком.
<b>SE</b>	Varning! Farlig spänning! Installation får endast utföras av en elektriker.
<b>SK</b>	Varovanie! Nebezpečné napätie! Montáž môže vykonávať iba skúsený elektrotechnik.
<b>SL</b>	Opozorilo! Nevarna napetost! Vgradnjo lahko opravi le oseba z elektrotehničnim strokovnim znanjem.



---

## Contact us

### **ABB Oy**

P.O. Box 622  
FI-65101 Vaasa  
Finland

**[abb.com/lowvoltage](http://abb.com/lowvoltage)**