

CATALOG

Blackburn®
Mechanical connectors



Thomas & Betts is now ABB Installation Products, but our long legacy of quality products and innovation remains the same. From connectors that help wire buildings on Earth to cable ties that help put machines in space, we continue to work every day to make, market, design and sell products that provide a smarter, safer and more reliable flow of electricity, from source to socket.

Table of contents

004	Overview
005–008	Split-bolt connectors
009–010	Service post connectors
011	Parallel groove connectors
012	Insulation piercing connectors
013–014	Two-bolt connectors
015–022	Insulated multi-taps
023–025	Power distribution blocks
026–033	Dual-rated mechanical connectors
034–042	Copper mechanical connectors
043	Clamp connectors
044–047	Index

Overview

—
01 Copper split-bolt connectors
See page 5

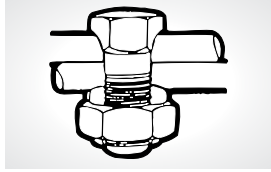

—
01 Type H, HPS, HPW

—
02 Aluminum split-bolt connectors
See page 7

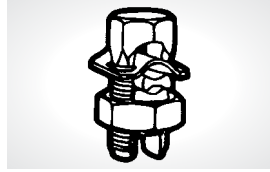

—
02 Type APS, AAW, CA

—
03 Service post connectors
See page 9

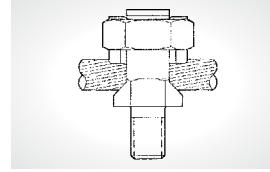

—
03 Type SP

—
04 ViceLock
See page 11

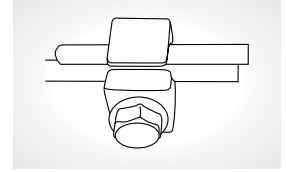

—
04 ViceLock™

—
05 Insulation piercing connectors
See page 12

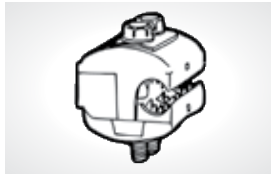

—
05 Type IPC

—
06 Two-bolt connectors
See page 13

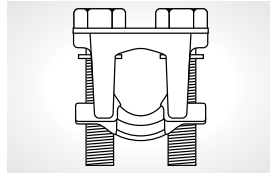

—
06 Type 2B, 2BX, 2BW, 2BPW

—
07 CSB and AMT connectors
See page 15

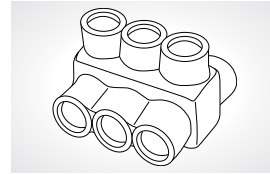

—
07 Insulated multi-tap

—
08 Power distribution blocks
See page 23

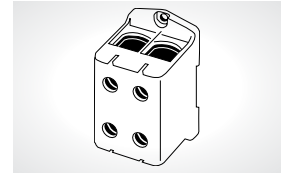

—
08 PDS

—
09 Dual-rated mechanical connectors
See page 26

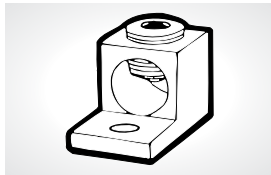

—
09 Type ADR

—
10 Dual-rated mechanical connectors
See page 31

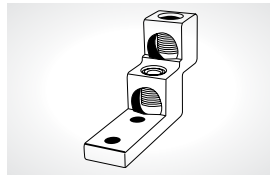

—
10 Type ASL

—
11 Splicer reducer
See page 32

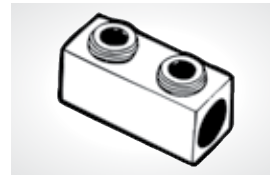

—
11 Type ASR

—
12 Rectangular connectors
See page 32

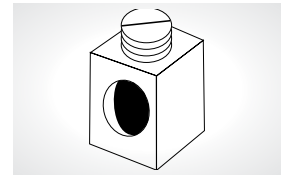

—
12 Type BX

—
13 Aluminum parallel tap connectors
See page 33



—
13 Type GP, GT

—
14 Insulating covers
See page 33

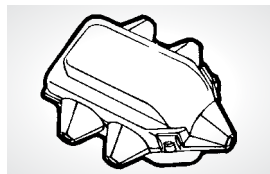

—
14 Type TC

—
15 Copper mechanical connectors
See page 34



—
15 Type L, TL

—
16 Copper splice
See page 34

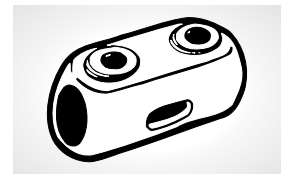

—
16 Type S

—
17 Direct-burial splice kits
See page 35



—
17 UFSK, DBSK

—
18 Copper mechanical connectors
See page 35

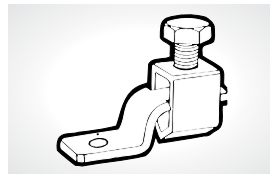

—
18 Type STC, BTC

—
19 LOCKTITE connectors
See page 36



—
19 LOCKTITE®

—
20 Tap connectors
See page 42



—
20 Tap

Split-bolt connectors

Type H – High-strength split-bolt connectors



Type H – High-strength split-bolt connectors

For copper-to-copper connections.

- Bolt and nut of high-strength corrosion-resistant bronze alloy
- Pressure bar is copper through 40H, copper alloy for 350 kcmil and above
- Bolt and nut of hex design up to 350 kcmil
- Tested and listed to UL486C, UL467 for grounding and for direct burial through Cat. No. 40H



Cat. no.	Conductor range (AWG or kcmil)		Dimensions (in.)			
	Range for equal main and tap	Min. tap with one max. main	A	B	C	D
9H	10 Str.–12 Sol.	14 Sol.	$\frac{3}{8}$	0.146	$\frac{1}{2}$	$\frac{25}{32}$
8H	8 Str.–10 Sol.	14 Sol.	$\frac{3}{8}$	0.146	$\frac{1}{2}$	$\frac{25}{32}$
8H3*	8 Str.–12 Sol.	16 Str.	$\frac{3}{8}$	0.146	$\frac{1}{2}$	$\frac{29}{32}$
6H	6 Sol.–8 Sol.	14 Sol.	$\frac{15}{32}$	0.170	$\frac{21}{32}$	$\frac{31}{32}$
6H3*	6 Sol.–10 Sol.	16 Str.	$\frac{15}{32}$	0.170	$\frac{21}{32}$	$1\frac{1}{8}$
4H	4 Sol.–8 Sol.	14 Sol.	$\frac{17}{32}$	0.235	$\frac{23}{32}$	$1\frac{1}{16}$
4H3*	4 Sol.–8 Sol.	16 Str.	$\frac{17}{32}$	0.235	$\frac{23}{32}$	$1\frac{9}{32}$
3H	3 Sol.–8 Sol.	16 Str.	$\frac{17}{32}$	0.235	$\frac{23}{32}$	$1\frac{1}{16}$
3H3*	4 Str.–8 Sol.	16 Str.	$\frac{17}{32}$	0.235	$\frac{23}{32}$	$1\frac{9}{32}$
2H	2 Sol.–6 Sol.	14 Sol.	$\frac{19}{32}$	0.271	$\frac{25}{32}$	$1\frac{1}{4}$
2H3*	2 Sol.–6 Sol.	14 Sol.	$\frac{19}{32}$	0.271	$\frac{25}{32}$	$1\frac{15}{32}$
1H	2 Str.–6 Sol.	14 Sol.	$\frac{11}{16}$	0.330	$\frac{7}{8}$	$1\frac{11}{32}$
1H3**	2 Str.–6 Sol.	14 Sol.	$\frac{11}{16}$	0.330	$\frac{7}{8}$	$1\frac{5}{8}$
10H	1/0 Str.–4 Sol.	14 Sol.	$\frac{3}{4}$	0.385	$\frac{15}{16}$	$1\frac{19}{32}$
20H	2/0 Str.–2 Sol.	14 Sol.	$\frac{7}{8}$	0.443	$1\frac{1}{16}$	$1\frac{13}{16}$
30H	4/0 Str.–2 Sol.	6 Sol.	1	0.580	$1\frac{5}{16}$	$2\frac{5}{32}$
40H	250 kcmil–1 Str.	8 Sol.	1	0.580	$1\frac{5}{16}$	$2\frac{5}{32}$
350M	350 kcmil–250 kcmil	1/0 Str.	$\frac{15}{16}$	0.717	$1\frac{21}{32}$	$2\frac{11}{16}$
500M	500 kcmil–400 kcmil	2/0 Str.	$1\frac{1}{2}$	0.842	$1\frac{7}{8}$	$3\frac{3}{32}$
750M	750 kcmil–600 kcmil	4/0 Str.	$1\frac{15}{16}$	1.029	$2\frac{1}{4}$	$3\frac{21}{32}$
1000M	1,000 kcmil–800 kcmil	4/0 Str.	$2\frac{1}{4}$	1.185	$2\frac{17}{32}$	$4\frac{1}{32}$

Diagram

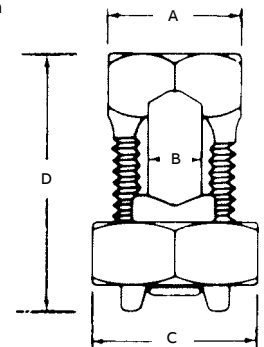

* Will accommodate three wires of maximum size.

** Will accommodate three #2 stranded wires.

The H3 bolts are not UL® listed or CSA certified.

UL recognizes solid and stranded conductor configurations for sizes #8 and smaller and stranded configurations only for sizes #6 and larger.

Split-bolt connectors

Type HPS – Plated split-bolt connectors with spacer



For use on copper, aluminum and ACSR conductors.

- Bolt and pressure bar of copper alloy, completely tin plated for corrosion resistance
- Contoured spacer of electrolytic copper up through 4/0, bronze alloy for 350 kcmil and above, all tin plated

- Most connectors are UL® listed and CSA certified for copper conductor only
- Blackburn® Contax® paste recommended when used on aluminum conductor

Type HPS – Plated split-bolt connectors with spacer



Diagram	Cat. no.	Conductor range (AWG or kcmil)			Dimensions (in.)			
		Range for equal main and tap		Min. tap with one max. main	A	B	C	D
		ACSR	Copper or aluminum					
	9HPS	–	10 Str.–12 Sol.	12 Sol.	3/8	0.146	1/2	29/32
	8HPS	–	8 Str.–12 Sol.	12 Sol.	3/8	0.146	1/2	29/32
	6HPS	8	6 Sol.–12 Sol.	12 Sol.	15/32	0.170	21/32	1 1/8
	4HPS	6–8	4 Sol.–12 Sol.	12 Sol.	17/32	0.235	23/32	1 9/32
	2HPS	4–8	2 Sol.–8 Sol.	8 Sol.	19/32	0.271	25/32	1 15/32
	1HPS	2–8	1 Str.–8 Sol.	8 Sol.	1 1/16	0.330	7/8	1 5/8
	10HPS	1–6	1/0 Str.–6 Sol.	6 Sol.	3/4	0.385	1 5/16	1 13/16
	20HPS	1/0–6	2/0 Str.–6 Str.	6 Sol.	7/8	0.443	1 1/16	2 1/16
	40HPS	4/0–4	4/0 Str.–4 Sol.	4 Sol.	1	0.580	1 5/16	2 15/32
	350HPS	266.8–1/0	350 kcmil–1/0 Str.	2 Sol.	1 5/16	0.717	1 21/32	2 11/16
	500HPS*	397.5–1/0	500 kcmil–1/0 Str.	1/0 Str.	1 1/2	0.842	1 7/8	3 1/32
	750HPS*	666.6–4/0	750 kcmil–4/0 Str.	2/0 Str.	1 15/16	1.029	2 1/4	3 21/32
1000HPS*	900–477	1,000 kcmil–500 kcmil	4/0 Str.	2 1/4	1.185	2 17/32	4 1/32	

* Not CSA certified. UL 486A.

Split-bolt connectors

Type HPW and Type APS



For combinations of copper, aluminum and ACSR conductors.

- Bolt and pressure bar of high-strength copper alloy completely tin plated
- Spacer and washer of electrolytic copper up through 4/0, bronze alloy 350 kcmil and above, all tin plated

- Contoured spacer and bell mouth washer distribute pressure over large area of conductor
- Large contoured spacer provides wide separation between copper and aluminum conductors
- Blackburn® Contax® paste recommended when used with aluminum conductor

Type HPW – Plated split-bolt connectors with spacer and washer

Diagram	Cat. no.	Conductor range (AWG)			Dimensions (in.)			
		Range for equal main and tap	Range for equal main and tap	Min. tap with one max. main	A	B	C	D
		ACSR	Copper or aluminum					
	6HPW	8	6 Sol.–12 Sol.	12 Sol.	¹⁵ / ₃₂	0.170	²¹ / ₃₂	¹ / ₈
	4HPW	6–8	4 Sol.–12 Sol.	12 Sol.	¹⁷ / ₃₂	0.235	²³ / ₃₂	¹⁹ / ₃₂
	2HPW	4–8	2 Sol.–8 Sol.	8 Sol.	¹⁹ / ₃₂	0.271	²⁵ / ₃₂	¹⁵ / ₃₂
	1HPW	2–8	1 Str.–8 Sol.	8 Sol.	¹¹ / ₁₆	0.330	⁷ / ₈	¹⁵ / ₈
	10HPW	1–6	1/0 Str.–6 Sol.	6 Sol.	³ / ₄	0.385	¹⁵ / ₁₆	¹¹³ / ₁₆
	20HPW	1/0–6	2/0 Str.–6 Sol.	6 Sol.	⁷ / ₈	0.443	¹¹ / ₁₆	²¹ / ₁₆
	40HPW	4/0–4	4/0 Str.–4 Sol.	4 Sol.	1	0.580	¹⁵ / ₁₆	²¹⁵ / ₃₂



Accommodates all aluminum and copper conductor combinations.

- Six bolts cover range from #10 to 4/0 AWG
- Install with standard wrenches
- Corrosion-resistant tin-plated aluminum
- Tested and listed to UL® 486B, 90 °C requirements

Type APS – Aluminum dual-rated split-bolt connectors



Diagrams	Cat. no.	Conductor range (AWG or kcmil) equal main and tap	Dimensions (in.)				
			A	B	C	D	E
	APS06	6–10 Str.	¹⁷ / ₃₂	0.21	²³ / ₃₂	1.27	¹ / ₄
	APS04	4–10 Str.	¹⁹ / ₃₂	0.27	²⁵ / ₃₂	1.48	¹ / ₄
	APS02	2–8 Str.	¹¹ / ₁₆	0.33	⁷ / ₈	1.63	¹ / ₄
	APS11	1/0–4 Str.	⁷ / ₈	0.44	¹ / ₈	2.07	¹ / ₂
	APS21	2/0–4 Str.	⁷ / ₈	0.44	¹ / ₈	2.07	¹ / ₂
	APS41	4/0–2 Str.	¹ / ₈	0.54	¹ / ₂	2.47	1.55
	APS350*	350 kcmil–4 Str.	¹⁷ / ₁₆	0.70	¹¹ / ₁₆	3.36	² / ₄
	APS500*	500 kcmil–2 Str.	¹¹ / ₁₆	0.84	2	3.62	²⁵ / ₈

* Square head design not CSA certified

Split-bolt connectors

Type AAW and Type CA



For all-aluminum applications.

- Bolt, nut, pressure bar and contoured spacer of aluminum alloy
- Large contoured spacer provides wide separation

- Nut anodized to prevent thread galling
- Blackburn® Contax® paste recommended when used on aluminum conductor

Type AAW – Aluminum split-bolt connectors with spacer and washers

Diagram	Cat. no.	Conductor range (AWG)			Dimensions (in.)			
		Range for equal main and tap	Range for equal main and tap	Min. tap with one max. main	A	B	C	D
		ACSR	Aluminum	–				
	6AAW	6–8	4 Sol.–8 Sol.	10 Sol.	¹⁷ / ₃₂	0.236	²³ / ₃₂	¹⁹ / ₃₂
	4AAW	4–8	2 Sol.–8 Sol.	8 Sol.	¹⁹ / ₃₂	0.272	²⁵ / ₃₂	¹⁵ / ₃₂
	2AAW	2–8	1 Str.–8 Sol.	8 Sol.	¹¹ / ₁₆	0.330	⁷ / ₈	¹ / ₈
	1AAW	1–4	1/0 Str.–2 Sol.	4 Sol.	⁷ / ₈	0.443	¹ / ₈	² / ₁₆
	10AAW	1/0–4	2/0 Str.–2 Sol.	4 Sol.	⁷ / ₈	0.443	¹ / ₈	² / ₁₆
	40AAW	4/0–4	4/0 Str.–4 Sol.	4 Sol.	1	0.580	¹ / ₄	² / ₁₅



Contoured spacer and bell-mouth washer distribute pressure over large area of conductor.

- Bolt, nut and washer made of high-strength aluminum alloy
- Pressure bar and contoured spacer made of electrolytic copper

- Spacer is completely tin plated
- Bolt and nut are anodized to prevent seizing of threads and reduce galvanic corrosion when in contact with copper conductor
- Blackburn Contax paste recommended with this connector

Type CA – Aluminum split-bolt connectors with spacer and washer

Diagram	Cat. no.	Conductor range (AWG)			Dimensions (in.)			
		Range for equal main and tap	Min. tap with one max. main		A	B	C	D
			Copper or aluminum					
	6CA	4 Sol.–6 Sol.	4 Sol.–12 Sol.		¹⁷ / ₃₂	0.236	²³ / ₃₂	¹⁹ / ₃₂
	4CA	2 Sol.–4 Sol.	2 Sol.–10 Sol.		¹⁹ / ₃₂	0.272	²⁵ / ₃₂	¹⁵ / ₃₂
	2CA	1 Str.–4 Sol.	1 Str.–8 Sol.		¹¹ / ₁₆	0.330	⁷ / ₈	¹ / ₈
	1CA	1/0 Str.–2 Sol.	1/0 Str.–6 Sol.		⁷ / ₈	0.443	¹ / ₈	² / ₁₆
	10CA	2/0 Str.–2 Sol.	2/0 Str.–6 Sol.		⁷ / ₈	0.443	¹ / ₈	² / ₁₆
	40CA	4/0 Str.–2/0 Sol.	4/0 Str.–4 Sol.		1	0.580	¹ / ₄	² / ₁₅

Service post connectors

For grounding of steel structures, fence posts or transformers using one or two cables.

—
01 Single-conductor
short stud
See page 10

—
02 Double-conductor
short stud
See page 10

—
03 Single-conductor
long stud
See page 10

—
04 Double-conductor
long stud
See page 10

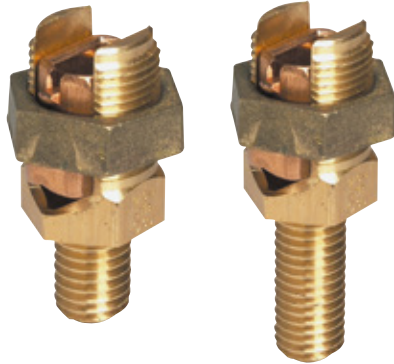

- For copper-to-copper connections
- For tapping one or two cables from bus bar
- Hex design bolts machined from high-conductivity bronze alloy
- Nuts and pressure bars cold-formed from high-strength copper or copper alloy
- Available in sizes for #12 – 500 kcmil stranded and #12 – #2 solid copper conductor
- Available in both single- and double-conductor versions
- UL® 486A and UL 467 listed

Blackburn® service post connectors are designed for applications including steel structure, fence post or transformer grounding involving one or two cables. They can also be used to tap one or two cables from bus bar.

Dimensions

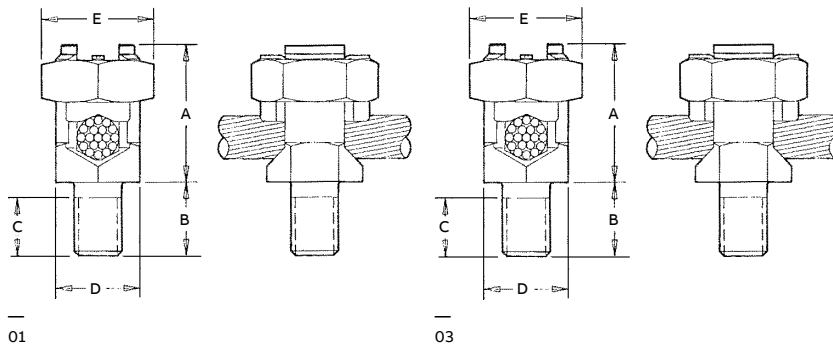

01

03

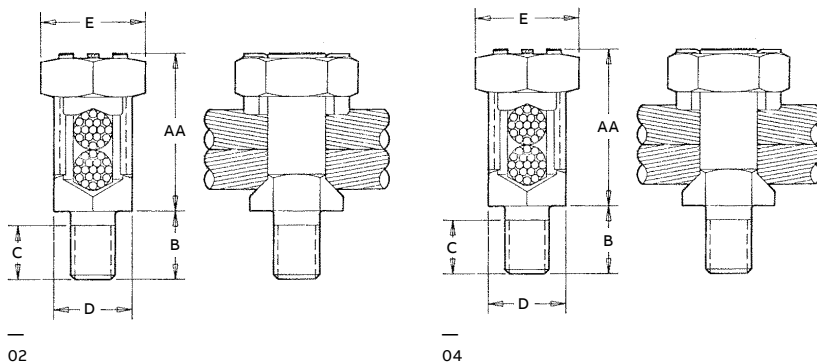

02

04

Bolts used in the service post connectors are machined from high-conductivity bronze alloy while the nuts are cold-formed from high strength, corrosion-resistant copper alloy. Pressure bars are copper through 4/0 size, while copper alloy is used for 350 kcmil size and above.

Bolts and nuts are of the traditional Blackburn hex design for easy installation.

Service post connectors

Single- and double-conductor service post connectors, short stud and long stud

Single- and double-conductor service post connectors, short stud



Cat. no.		Conductor range AWG (mm ²)				Diameter range (in.)	Stud size	Dimensions (in.)					
		Stranded		Solid				A	AA	B	C	D	E
SP-DS	SP-SS	Max.	Min.	Max.	Min.								
SP0DS	SP0SS	8 (6)	12 (4)	8 (10)	12 (4)	0.146–0.081 –	¼–20 x ½	1 ¹ / ₁₆	1 ³ / ₁₆	½	5 ⁵ / ₆₄	1 ⁵ / ₃₂	½
SP1DS	SP1SS	7 (10)	10 (6)	6 (10)	10 (6)	0.164–0.102 –	¼–20 x ½	1 ³ / ₁₆	3 ¹ / ₃₂	½	5 ⁵ / ₆₄	1 ⁵ / ₃₂	2 ¹ / ₃₂
SP2DS	SP2SS	5 (16)	10 (6)	4 –	10 –	0.206–0.102 –	5 ¹⁶ –18 x 5 ⁸	1 ⁵ / ₁₆	1 ¹ / ₈	5 ⁸	5 ³ / ₆₄	1 ⁷ / ₃₂	2 ³ / ₃₂
SP3DS	SP3SS	3 (25)	10 (6)	2 –	10 –	0.26–0.102 –	¾–16 x 5 ⁸	½	1 ¹ / ₄	5 ⁸	6 ¹ / ₆₄	5 ⁸	2 ⁵ / ₃₂
SP4DS	SP4SS	1 (35)	8 (10)	2 –	8 –	0.332–0.129 –	¾–16 x 5 ⁸	1 ¹ / ₁₆	1 ³ / ₈	5 ⁸	6 ¹ / ₆₄	1 ¹¹ / ₁₆	7 ⁸
SP5DS	SP5SS	1/0 (50)	2 (35)	1/0 –	2 –	0.373–0.258 –	½–13 x ¾	1 ¹ / ₄	1 ¹⁹ / ₃₂	¾	1 ⁵ / ₆₄	¾	1 ⁵ / ₁₆
SP6DS	SP6SS	2/0 (50)	2 (35)	2/0 –	2 –	0.419–0.258 –	½–13 x ¾	1 ¹³ / ₃₂	1 ¹³ / ₁₆	¾	1 ⁵ / ₆₄	7 ⁸	1 ¹ / ₁₆
SP8DS	SP8SS	4/0 (95)	2 (35)	4/0 –	1 –	0.528–0.289 –	5 ⁸ –11 x 1	1 ⁹ / ₁₆	2 ¹ / ₁₆	1	1 ¹⁹ / ₆₄	1	1 ⁵ / ₁₆
SP9DS	SP9SS	350 (150)	1/0 (50)	– –	– –	0.681–0.373 –	5 ⁸ –11 x 1	2	2 ³ / ₄	1 ¹ / ₄	1 ¹⁹ / ₆₄	1 ⁵ / ₁₆	1 ¹¹ / ₁₆
SP10DS	SP10SS	500 (240)	3/0 (95)	– –	– –	0.814–0.47 –	¾–10 x 1 ¹ / ₄	2 ¹ / ₄	3 ¹ / ₈	1 ³ / ₄	1 ³¹ / ₆₄	1 ¹ / ₂	1 ⁷ / ₈

Single- and double-conductor service post connectors, long stud



Cat. no.		Conductor range AWG (mm ²)				Diameter range (in.)	Stud size	Dimensions (in.)					
		Stranded		Solid				A	AA	B	C	D	E
SP-SL	SP-DL	Max.	Min.	Max.	Min.								
SP0SL	SP0DL	8 (6)	12 (4)	8 (10)	12 (4)	0.146–0.081 –	¼–20 x 1	1 ¹ / ₁₆	1 ³ / ₁₆	1	5 ⁵ / ₆₄	1 ⁵ / ₃₂	½
SP1SL	SP1DL	7 (10)	10 (6)	6 (10)	10 (6)	0.164–0.102 –	¼–20 x 1	1 ³ / ₁₆	3 ¹ / ₃₂	1	5 ⁵ / ₆₄	1 ⁵ / ₃₂	2 ¹ / ₃₂
SP2SL	SP2DL	5 (16)	10 (6)	4 –	10 –	0.206–0.102 –	5 ¹⁶ –18 x 1	1 ⁵ / ₁₆	1 ¹ / ₈	1	5 ³ / ₆₄	1 ⁷ / ₃₂	2 ³ / ₃₂
SP3SL	SP3DL	3 (25)	10 (6)	2 –	10 –	0.26–0.102 –	¾–16 x 1 ¹ / ₈	1	1 ¹ / ₄	1 ¹ / ₈	6 ¹ / ₆₄	5 ⁸	2 ⁵ / ₃₂
SP4SL	SP4DL	1 (35)	8 (10)	2 –	8 –	0.332–0.129 –	¾–16 x 1 ¹ / ₈	1 ¹ / ₁₆	1 ³ / ₈	1 ¹ / ₈	6 ¹ / ₆₄	1 ¹¹ / ₁₆	7 ⁸
SP5SL	SP5DL	1/0 (50)	2 (35)	1/0 –	2 –	0.373–0.258 –	½–13 x 1 ¹ / ₄	1 ¹ / ₄	1 ¹⁹ / ₃₂	1 ¹ / ₄	1 ⁵ / ₆₄	¾	1 ⁵ / ₁₆
SP6SL	SP6DL	2/0 (50)	2 (35)	2/0 –	2 –	0.419–0.258 –	½–13 x 1 ¹ / ₄	1 ¹³ / ₃₂	1 ¹³ / ₁₆	1 ¹ / ₄	1 ⁵ / ₆₄	7 ⁸	1 ¹ / ₁₆
SP8SL	SP8DL	4/0 (95)	2 (35)	4/0 –	1 –	0.528–0.289 –	5 ⁸ –11 x 1 ¹ / ₂	1 ⁹ / ₁₆	2 ¹ / ₁₆	1 ¹ / ₂	1 ¹⁹ / ₆₄	1	1 ⁵ / ₁₆
SP9SL	SP9DL	350 (150)	1/0 (50)	– –	– –	0.681–0.373 –	5 ⁸ –11 x 1 ¹ / ₂	2	2 ³ / ₄	1 ¹ / ₂	1 ¹⁹ / ₆₄	1 ⁵ / ₁₆	1 ¹¹ / ₁₆
SP10SL	SP10DL	500 (240)	3/0 (95)	– –	– –	0.814–0.47 –	¾–10 x 1 ¹ / ₄	2 ¹ / ₄	3 ¹ / ₈	1 ¹ / ₂	1 ³¹ / ₆₄	1 ¹ / ₂	1 ⁷ / ₈

Parallel groove connectors

Blackburn® bronze Vicelock® connectors

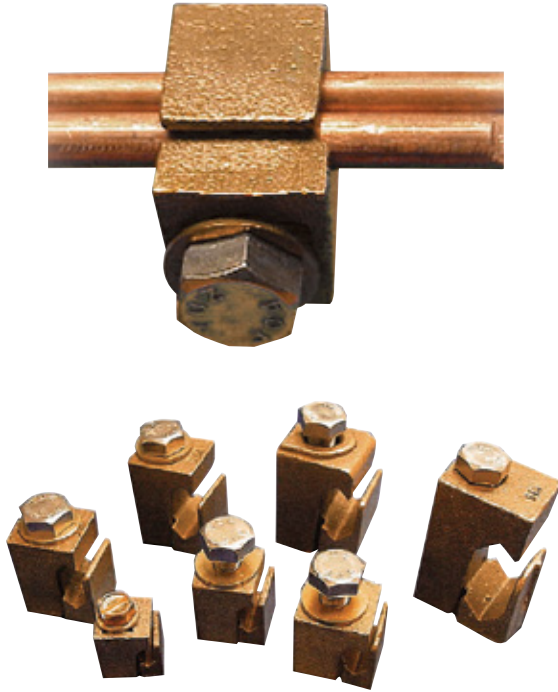

Create a superior electrical connection – While saving time and money.

- Offer superior electrical performance
- Make a permanent connection
- Vibration resistant
- Install quickly and easily with no need for special or heavy tools
- Can be installed with live line tools
- V-grooves enable easy conductor alignment
- Simple to install without cross-threading
- Full thread engagement design increases bolt strength
- High-pressure/torque ratio ensures a low electrical resistance connection
- Helps reduce inventory by accepting a wide range of conductors

Specifications

- Silicon bronze material (CDA956000) for higher yield strength
- Large sizes include stainless steel hardware
- Bellcore approved

Typical applications

- Distribution loads
- Service bonding
- Tap connections
- Ground connections
- Also has grounding capability with a variety of cable tray, channel and strut applications

Blackburn bronze Vicelock connectors

Cat. no.	2 Conductors wire range*			Inner ctn. qty.	Master ctn. qty.	Competitor cross ref.	
	Max.	Min.	Decimal (in.)			Fargo	Reliable
VGC68	#6 Sol.	#10 Sol.	0.162–0.101	50	250	GC-5006	BVC-6
VGC68SH	#6 Sol.	#10 Sol.	0.162–0.101	50	250	GC-5006SH	–
VGC44	#4 Str.	#8 Sol.	0.232–0.128	50	250	GC-5004	BVC-4
VGC23	#2 Sol.	#6 Sol.	0.286–0.162	50	250	GC-5002	BVC-2
VGC12	#2 Str.	#5 Sol.	0.320–0.181	50	250	GC-5002S	BVC-2S
VGC2010	1/0 Str.	#4 Sol.	0.390–0.204	50	250	GC-5020	BVC-20
VGC3020	2/0 Str.	#3 Sol.	0.438–0.229	25	125	GC-5020S	BVC-20S
VGC4040	4/0 Str.	#1 Sol.	0.552–0.289	25	125	GC-5040	BVC-40

* Wire range indicates each connector's ability to accommodate two wires of the same size shown in the "Max." or "Min." columns.

Insulation piercing connectors

Type IPC – Talon insulation piercing connectors



No need to strip conductor insulation or use tape after installation.

- For copper-to-copper, copper-to-aluminum and aluminum-to-aluminum applications (insulated conductor only)
- Performs as splice or tap for non-tension applications up to 600 V, depending on size of connector
- Self insulated for hot line applications
- Six sizes cover range from #10–500 kcmil
- UL® 486B listed AL9CU (90 °C rated)

Type IPC – Talon insulation piercing connectors



Diagrams	Cat. no.	Al or Cu conductor range AWG or kcmil/mm ²		No. bolts	Fig.	Dimensions (in.)		
		Main	Tap			W	H	L
<p>Fig. 1</p>	IPC1102*	1/0–8 50–6	2–8 35–6	1	1	2 ⁹ / ₁₆	2	1 ¹⁷ / ₃₂
	IPC4111	4/0–1/0 95–50	1/0–6 50–16	2	2	2 ¹ / ₂	3	1 ¹⁹ / ₃₂
<p>Fig. 2</p>	IPC4141	4/0–1/0 95–50	4/0–1/0 95–50	2	2	2 ⁵ / ₈	3 ¹ / ₄	1 ²⁹ / ₃₂
	IPC5041*	500–350 240–185	4/0–4 90–25	1	1	2	2 ¹ / ₂	2 ³ / ₈
	IPC3535	350–4/0 185–95	350–4/0 185–95	2	2	2 ¹ / ₁₆	2 ¹ / ₂	2 ³ / ₈
	IPC3541	350–4/0 185–95	4/0–10 95–6	1	1	2 ³ / ₄	3	2 ⁵ / ₈

* 600 V rating (all others 300 V).

Two-bolt connectors

Type 2B and 2BX



Neoprene washers capture bolts in bottom casting for easy installation.

- Castings and bolts of high-strength copper alloy
- Removable cap
- UL® 486A listed for copper conductor only



Type 2B – Two-bolt connector without spacer

Diagram	Cat. no.	Conductor range (AWG or kcmil)			Conductor diameter (B)			Dimensions (in.)			
		Max.	Min.	Max.	Min.	Max.	Min.	Bolt head	L	H	D
	2B10	1/0 Str.	2 Str.	1/0 Str.	10 Sol.	0.746	0.394	1/2	1 5/16	1 3/4	5/16
	2B20BB	2/0 Str.	2 Str.	2/0 Str.	8 Sol.	0.838	0.420	1/2	1 5/16	1 1/4	5/16
	2B40	4/0 Str.	1/0 Str.	4/0 Str.	6 Sol.	1.056	0.530	9/16	1 23/32	1 3/4	3/8
	2B350	350 kcmil	4/0 Str.	350 kcmil	4 Sol.	1.362	0.726	3/4	2 1/8	2	1/2
	2B500	500 kcmil	350 kcmil	500 kcmil	4 Sol.	1.626	0.883	3/4	2 1/4	2 1/2	1/2
	2B800	800 kcmil	600 kcmil	800 kcmil	2 Sol.	2.062	1.149	3/4	2 1/2	2 1/2	1/2
	2B1000	1000 kcmil	750 kcmil	1000 kcmil	2 Sol.	2.304	1.255	15/16	2 31/32	2 3/4	5/8

UL 486A



Extra-long bolt enables top casting to swing free over two conductors of maximum range.

- Single-piece construction
- Castings and bolts of high-strength copper alloy
- Neoprene washer holds free bolt in place during installation
- UL® 486A listed for copper conductor only



Type 2BX – One-piece two-bolt connector without spacer

Diagram	Cat. no.	Conductor range (AWG or kcmil)			Conductor diameter (B)			Dimensions (in.)			
		Max.	Min.	Max.	Min.	Max.	Min.	Bolt head	L	H	D
	2B10X	1/0 Str.	2 Str.	1/0 Str.	10 Sol.	0.746	0.394	1/2	1 5/16	1 1/2	5/16
	2B20X	2/0 Str.	2 Str.	2/0 Str.	8 Sol.	0.838	0.420	1/2	1 5/16	1 1/2	5/16
	2B40X	4/0 Str.	1/0 Str.	4/0 Str.	6 Sol.	1.056	0.530	9/16	1 23/32	1 7/8	3/8
	2B350X	350 kcmil	4/0 Str.	350 kcmil	4 Sol.	1.362	0.726	3/4	2 1/8	2 1/4	1/2
	2B500X	500 kcmil	350 kcmil	500 kcmil	4 Sol.	1.626	0.883	3/4	2 1/4	2 1/2	1/2
	2B800X	800 kcmil	600 kcmil	800 kcmil	2 Sol.	2.062	1.149	3/4	2 1/2	2 3/4	1/2
	2B1000X	1000 kcmil	750 kcmil	1000 kcmil	2 Sol.	2.304	1.255	15/16	2 31/32	3 1/4	5/8

UL 486A

Two-bolt connectors

Type 2BW and Type 2BPW



Type 2BW – Two-bolt connector with spacer

Ringed, contoured spacer swings easily over conductor.

- For use on copper conductors only
- Single-piece construction spacer
- Castings and bolts made of high-strength copper alloy
- Spacer made of ductile, high-conductivity copper alloy
- UL® 486A listed for copper conductor only



Diagram	Cat. no.	Conductor range (AWG or kcmil)				Conductor diameter				Bolt head (in.)	Dimensions (in.)		
		Main		Tap	A		B	L	H		E		
		Max.	Min.		Max.	Min.						Max.	Min.
	2B10W	1/0 Str.	2 Str.	1/0 Str.	10 Sol.	0.373	0.292	0.373	0.102	1/2	1 5/16	1 5/8	5/16
	2B20W	2/0 Str.	2 Str.	2/0 Str.	8 Sol.	0.419	0.292	0.419	0.128	1/2	1 5/16	1 5/8	5/16
	2B40W	4/0 Str.	1/0 Str.	4/0 Str.	6 Sol.	0.528	0.368	0.528	0.162	9/16	1 23/32	2 1/8	3/8
	2B350W	350 kcmil	4/0 Str.	350 kcmil	4 Sol.	0.681	0.522	0.681	0.204	3/4	2 1/8	2 1/2	1/2
	2B500W	500 kcmil	350 kcmil	500 kcmil	4 Sol.	0.813	0.679	0.813	0.204	3/4	2 1/4	2 3/4	1/2
	2B800W	800 kcmil	600 kcmil	800 kcmil	2 Sol.	1.031	0.891	1.031	0.258	3/4	2 1/2	3 1/4	1/2
	2B1000W	1000 kcmil	750 kcmil	1000 kcmil	2 Sol.	1.152	0.997	1.152	0.258	15/16	2 31/32	3 3/4	5/8



Type 2BPW – Two-bolt connector with spacer

For use on copper, aluminum and ACSR conductors.

- Single-piece construction spacer
- UL® 486A listed for copper conductor only



Diagram	Cat. no.	Conductor range (AWG or kcmil)				Conductor diameter				Bolt head (in.)	Dimensions (in.)		
		Main		Tap	A		B	L	H		E		
		Max.	Min.		Max.	Min.						Max.	Min.
	2B10PW	1/0–2	1/0–6	1/0 Str.–2 Str.	1/0 Str.–2 Sol.	0.398	0.292	0.398	0.102	1/2	1 5/16	1 5/8	5/16
	2B20PW	2/0–2	2/0–6	2/0 Str.–2 Str.	1/0 Str.–2 Sol.	0.447	0.292	0.447	0.128	1/2	1 5/16	1 5/8	5/16
	2B40PW	4/0–1/0	4/0–6	4/0 Str.–1/0 Str.	4/0 Str.–1/0 Sol.	0.563	0.368	0.563	0.162	9/16	1 23/32	2 1/8	3/8
	2B350PW	350–4/0	350–4	350–4/0	350–4 Sol.	0.680	0.522	0.680	0.204	3/4	2 1/8	2 1/2	1/2
	2B500PW	397.5–336.4	397.5–4	500–350	500–4 Sol.	0.813	0.679	0.813	0.204	3/4	2 1/4	2 3/4	1/2
	2B800PW	666.6–397.5	666.6–2	800–600	800–2 Sol.	1.031	0.891	1.031	0.258	3/4	2 1/2	3 1/4	1/2
	2B1000PW	900–666.6	900–2	1000–750	1000–2 Sol.	1.162	0.997	1.162	0.258	15/16	2 31/32	3 3/4	5/8

Insulated multi-taps

Aluminum multi-tap encapsulated cable blocks – One-way configuration



CSR 2/0



CSB 250-5 S

These dual-rated blocks can be used with copper or aluminum cable.

- Versatile design supports a wide range of cable sizes and number of outlets available in one-way configurations
- Clear PVC insulation enables safe and time-saving installation with no taping required
- Meets or exceeds ANSI C119.4 specifications



Aluminum multi-tap encapsulated cable blocks – One-way configuration

Clear Cat. no.	No. of outlets	Wire range (AWG or kcmil)	Screw size	Dimensions (in.)		
				Length	Width	Height
Splices						
CSR 2/0	2	#14–2/0	3/8 Hex	2 3/4	7/8	1 3/8
CSR 250	2	#6–250		4 1/8	1 1/8	2 1/8
CSR 350	2	#6–350		4 3/4	1 3/8	2 1/2
CSR 500	2	2/0–500		6 1/2	1 5/8	2 7/8
Cable blocks						
CSB 4-2 S	2	#4–#14	Slotted	1 1/8	1 5/8	1 5/16
CSB 4-3 S	3			1 9/16		
CSB 4-4 SAH*	4			2 1/16		
CSB 4-5 S	5			2 9/16		
CSB 4-6 S	6			3 1/16		
CSB 4-7 S	7			3 9/16		
CSB 4-8 SAH*	8			4 1/16		
CSB 2/0-2 S	2	2/0–#14	3/16 Hex	1 7/8	1 3/4	1 3/8
CSB 2/0-3 S	3			2 3/8		
CSB 2/0-4 S	4			3 1/8		
CSB 2/0-5 S	5			3 7/8		
CSB 2/0-6 S	6			4 5/8		
CSB 2/0-7 S	7			5 3/8		
CSB 2/0-8 S	8			6 1/8		
CSB 250-2 S	2	250–#6	5/16 Hex	1 7/8	2 5/8	2 1/8
CSB 250-3 S	3			2 27/32		
CSB 250-4 S	4			3 13/16		
CSB 250-5 S	5			4 25/32		
CSB 250-6 S	6			5 3/4		
CSB 250-7 S	7			6 3/4		
CSB 250-8 S	8			7 45/64		
CSB 350-2 S	2	350–#10	5/16 Hex	2 1/4	3 1/8	2 1/2
CSB 350-3 S	3			3 1/4		
CSB 350-4 S	4			4 1/4		
CSB 350-5 S	5			5 1/4		
CSB 350-6 S	6			6 1/4		
CSB 350-7 S	7			7 1/4		
CSB 350-8 S	8			8 1/4		
CSB 500-2 S	2	500–#6	5/16 Hex	2 7/8	3 3/16	2 3/4
CSB 500-3 S	3			4 1/8		
CSB 500-4 S	4			5 3/8		
CSB 500-5 S	5			6 5/8		
CSB 500-6 S	6			7 7/8		
CSB 500-7 S	7			9 1/8		
CSB 500-8 S	8			10 3/8		

* Not UL[®] listed, includes hex screw.

Insulated multi-taps

Aluminum multi-tap encapsulated cable blocks – Two-way configuration

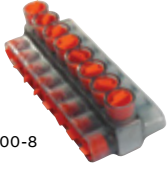

CSB 500-8

These dual-rated blocks can be used with copper or aluminum cable.

- Versatile design supports a wide range of cable sizes and number of outlets available in one-way configurations

- Clear PVC insulation enables safe and time-saving installation with no taping required
- Meets or exceeds ANSI C119.4 specifications

Aluminum multi-tap encapsulated cable blocks – Two-way configuration



Clear Cat. no.	No. of outlets	Wire range (AWG or kcmil)	Screw size	Dimensions (in.)		
				Length	Width	Height
CSB 4-2	2	#4-#14	Slotted	1 $\frac{1}{8}$	1 $\frac{5}{8}$	1 $\frac{5}{16}$
CSB 4-3	3			1 $\frac{9}{16}$		
CSB 4-4	4			2 $\frac{1}{16}$		
CSB 4-5	5			2 $\frac{9}{16}$		
CSB 4-6	6			3 $\frac{1}{16}$		
CSB 4-7	7			3 $\frac{9}{16}$		
CSB 4-8	8			4 $\frac{1}{16}$		
CSB 2/0-2	2	2/0-#14	$\frac{3}{16}$ Hex	1 $\frac{5}{8}$	1 $\frac{3}{4}$	1 $\frac{3}{8}$
CSB 2/0-3	3			2 $\frac{3}{8}$		
CSB 2/0-4	4			3 $\frac{1}{8}$		
CSB 2/0-5	5			3 $\frac{7}{8}$		
CSB 2/0-6	6			4 $\frac{5}{8}$		
CSB 2/0-7	7			5 $\frac{3}{8}$		
CSB 2/0-8	8			6 $\frac{1}{8}$		
CSB 250-2	2	250-#6	$\frac{5}{16}$ Hex	1 $\frac{7}{8}$	2 $\frac{5}{8}$	2 $\frac{1}{8}$
CSB 250-3	3			2 $\frac{27}{32}$		
CSB 250-4	4			3 $\frac{13}{16}$		
CSB 250-5	5			4 $\frac{25}{32}$		
CSB 250-6	6			5 $\frac{3}{4}$		
CSB 250-7	7			6 $\frac{3}{4}$		
CSB 250-8	8			7 $\frac{45}{64}$		
CSB 350-2	2	350-#10	$\frac{3}{8}$ Hex	2 $\frac{1}{4}$	3 $\frac{1}{8}$	2 $\frac{1}{2}$
CSB 350-3	3			3 $\frac{1}{4}$		
CSB 350-4	4			4 $\frac{1}{4}$		
CSB 350-5	5			5 $\frac{1}{4}$		
CSB 350-6	6			6 $\frac{1}{4}$		
CSB 350-7	7			7 $\frac{1}{4}$		
CSB 350-8	8			8 $\frac{1}{4}$		
CSB 500-2	2	500-#6	$\frac{3}{8}$ Hex	2 $\frac{7}{8}$	3 $\frac{3}{16}$	2 $\frac{3}{4}$
CSB 500-3	3			4 $\frac{1}{8}$		
CSB 500-4	4			5 $\frac{3}{8}$		
CSB 500-5	5			6 $\frac{5}{8}$		
CSB 500-6	6			7 $\frac{7}{8}$		
CSB 500-7	7			9 $\frac{1}{8}$		
CSB 500-8	8			10 $\frac{3}{8}$		
CSB 750-2	2	750-1/0	$\frac{3}{8}$ Hex	3	3 $\frac{3}{8}$	2 $\frac{1}{4}$
CSB 750-3	3			4 $\frac{7}{16}$		
CSB 750-4	4			5 $\frac{3}{16}$		
CSB 750-5	5			7 $\frac{1}{4}$		
CSB 750-6	6			8 $\frac{5}{8}$		
CSB 750-7	7			10		
CSB 750-8	8			11 $\frac{17}{16}$		
CSB 750-9	9			12 $\frac{13}{16}$		
CSB 750-10	10			14 $\frac{1}{4}$		

Insulated multi-taps

AMT connectors

Superior connections with lower installation costs.

- PVC insulation eliminates insulation failures and reduces outage costs
- UV-resistant material
- Compact design provides space efficiencies
- UL® listed

The high quality and built-in flexibility of Blackburn® AMT connectors reduce the cost of field installations on splices, taps and terminations. They're easy and quick to install and provide superior insulation that lasts the life of the connection.

AMT aluminum splice



Cat. no.	Figure	No. of ports	Wire range (AWG or kcmil)	Length (in.)	Width (in.)	Height (in.)	Hex size (in.)	Std. pkg. qty.
AMTSR10	1	–	1/0–14 Str.	3.25	0.94	1.63	3/16	4
AMTSR250	1	–	250–6 Str.	3.96	1.19	2.17	5/16	4
AMTSR350	1	–	350–6 Str.	4.43	1.31	2.62	5/16	2
AMTSR500	1	–	500–4 Str.	5.38	1.44	3.03	3/8	2

AMT splice offset



Cat. no.	Figure	No. of ports	Wire range	Length (in.)	Width (in.)	Height (in.)	Hex size (in.)	Std. pkg. qty.
AMTTC4	3	2	4–14 Str.	1.24	1.25	1.42	1/8	12
AMTT10	3	2	1/0–14 Str.	1.63	1.63	1.63	3/16	6
AMTT20	3	2	2/0–14 Str.	1.41	1.50	1.35	Slotted screw	25
AMTT250	3	2	250–10 Str.	2.03	2.63	2.2	5/16	25

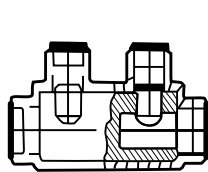

Fig. 1

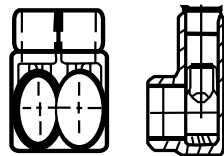

Fig. 2

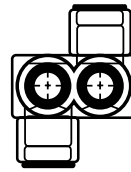

Fig. 3

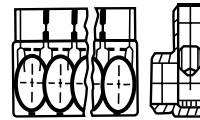

Fig. 4

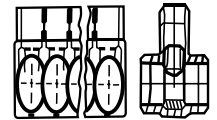

Fig. 5



Insulated multi-taps

AMT multi-port connector “same side”

AMT aluminum splice



Diagrams	Cat. no.	Fig.	No. of ports	Wire range (AWG or kcmil)	Length (in.)	Width (in.)	Height (in.)	Hex size (in.)	Std. pkg. qty.
<p>Fig. 1</p>	AMTC4	2	2	4–14 Str.	1.11	1.10	1.35	Slotted screw	25
	AMTS4142	2	2	4–14 Str.	1.24	1.22	1.42	1/8	12
	AMTS4143	4	3	4–14 Str.	1.7	1.22	1.42	1/8	12
	AMTS4144	4	4	4–14 Str.	2.16	1.22	1.42	1/8	6
	AMTS4145	4	5	4–14 Str.	2.61	1.22	1.42	1/8	6
	AMTS4146	4	6	4–14 Str.	3.07	1.22	1.42	1/8	6
	AMTS4147	4	7	4–14 Str.	3.53	1.22	1.42	1/8	4
	AMTS4148	4	8	4–14 Str.	3.99	1.22	1.42	1/8	4
	AMTS4149	4	9	4–14 Str.	4.45	1.22	1.42	1/8	4
	AMTS41410	4	10	4–14 Str.	4.9	1.22	1.42	1/8	4
<p>Fig. 2</p>	AMTS41411	4	11	4–14 Str.	5.36	1.22	1.42	1/8	3
	AMTS41412	4	12	4–14 Str.	5.82	1.22	1.42	1/8	3
	AMTS41413	4	13	4–14 Str.	6.28	1.22	1.42	1/8	2
	AMTS41414	4	14	4–14 Str.	6.74	1.22	1.42	1/8	2
	AMTS10142	2	2	1/0–14 Str.	1.67	1.53	1.63	3/16	12
	AMTS10143	4	3	1/0–14 Str.	2.29	1.53	1.63	3/16	12
	AMTS10144	4	4	1/0–14 Str.	2.92	1.53	1.63	3/16	6
	AMTS10145	4	5	1/0–14 Str.	3.54	1.53	1.63	3/16	6
	AMTS10146	4	6	1/0–14 Str.	4.17	1.53	1.63	3/16	6
	AMTS10147	4	7	1/0–14 Str.	4.79	1.53	1.63	3/16	4
	AMTS10148	4	8	1/0–14 Str.	5.42	1.53	1.63	3/16	4
	AMTS10149	4	9	1/0–14 Str.	6.04	1.53	1.63	3/16	4
	AMTS101410	4	10	1/0–14 Str.	6.67	1.53	1.63	3/16	4
	AMTS101411	4	11	1/0–14 Str.	7.29	1.53	1.63	3/16	3
<p>Fig. 3</p>	AMTS101412	4	12	1/0–14 Str.	7.92	1.53	1.63	3/16	3
	AMTS101413	4	13	1/0–14 Str.	8.54	1.53	1.63	3/16	2
	AMTS101414	4	14	1/0–14 Str.	9.17	1.53	1.63	3/16	2
	AMT20	2	2	2/0–14 Str.	1.41	1.10	1.35	5/16	25
	AMTS3062	2	2	3/0–6 Str.	1.89	1.58	1.86	3/16	12
	AMTS3063	4	3	3/0–6 Str.	2.65	1.58	1.86	3/16	6
	AMTS3064	4	4	3/0–6 Str.	3.42	1.58	1.86	3/16	6
	AMTS3065	4	5	3/0–6 Str.	4.18	1.58	1.86	3/16	4
	AMTS3066	4	6	3/0–6 Str.	4.95	1.58	1.86	3/16	4
	AMTS3067	4	7	3/0–6 Str.	5.71	1.58	1.86	3/16	3
	AMTS3068	4	8	3/0–6 Str.	6.48	1.58	1.86	3/16	3
	AMTS3069	4	9	3/0–6 Str.	7.24	1.58	1.86	3/16	3
	AMTS30610	4	10	3/0–6 Str.	8	1.58	1.86	3/16	2
	AMTS30611	4	11	3/0–6 Str.	8.77	1.58	1.86	3/16	2
<p>Fig. 4</p>	AMTS30612	4	12	3/0–6 Str.	9.54	1.58	1.86	3/16	2
	AMTS30613	4	13	3/0–6 Str.	10.3	1.58	1.86	3/16	2
	AMTS30614	4	14	3/0–6 Str.	11.07	1.58	1.86	3/16	2
	AMT250	2	2	250–10 Str.	2.03	2.00	2.20	5/16	25
	AMTS25062	4	2	250–6 Str.	2.17	1.91	2.17	5/16	6
	AMTS25063	4	3	250–6 Str.	3.07	1.91	2.17	5/16	6
	AMTS25064	4	4	250–6 Str.	3.96	1.91	2.17	5/16	6
	AMTS25065	4	5	250–6 Str.	4.85	1.91	2.17	5/16	4
	AMTS25066	4	6	250–6 Str.	5.75	1.91	2.17	5/16	4
	AMTS25067	4	7	250–6 Str.	6.64	1.91	2.17	5/16	3

Continued on next page

Insulated multi-taps

AMT multi-port connector “same side” (continued)

AMT aluminum splice (continued)



Diagrams	Cat. no.	Fig.	No. of ports	Wire range (AWG or kcmil)	Length (in.)	Width (in.)	Height (in.)	Hex size (in.)	Std. pkg. qty.
	AMTS25068	4	8	250–6 Str.	7.53	1.91	2.17	5/16	3
	AMTS25069	4	9	250–6 Str.	8.42	1.91	2.17	5/16	3
	AMTS250610	4	10	250–6 Str.	9.32	1.91	2.17	5/16	2
	AMTS250611	4	11	250–6 Str.	10.21	1.91	2.17	5/16	2
	AMTS250612	4	12	250–6 Str.	11.1	1.91	2.17	5/16	2
	AMTS250613	4	13	250–6 Str.	12	1.91	2.17	5/16	1
	AMTS250614	4	14	250–6 Str.	12.89	1.91	2.17	5/16	1
	AMT350	2	2	350–10 Str.	2.35	2.13	2.63	5/16	25
	AMTS35062	2	2	350–6 Str.	2.51	2.03	2.62	5/16	4
	AMTS35063	4	3	350–6 Str.	3.56	2.03	2.62	5/16	4
	AMTS35064	4	4	350–6 Str.	4.61	2.03	2.62	5/16	3
	AMTS35065	4	5	350–6 Str.	5.66	2.03	2.62	5/16	3
	AMTS35066	4	6	350–6 Str.	6.71	2.03	2.62	5/16	2
	AMTS35067	4	7	350–6 Str.	7.76	2.03	2.62	5/16	2
	AMTS35068	4	8	350–6 Str.	8.81	2.03	2.62	5/16	2
	AMTS35069	4	9	350–6 Str.	9.86	2.03	2.62	5/16	2
	AMTS350610	4	10	350–6 Str.	10.91	2.03	2.62	5/16	2
	AMTS350611	4	11	350–6 Str.	11.96	2.03	2.62	5/16	1
	AMTS350612	4	12	350–6 Str.	13.01	2.03	2.62	5/16	1
	AMTS350613	4	13	350–6 Str.	14.06	2.03	2.62	5/16	1
	AMTS350614	4	14	350–6 Str.	15.11	2.03	2.62	5/16	1
	AMT500	2	2	500–6 Str.	2.62	2.16	2.91	3/8	25
	AMTS50042	2	2	500–4 Str.	2.97	2.28	3.04	3/8	3
	AMTS50043	4	3	500–4 Str.	4.12	2.28	3.04	3/8	3
	AMTS50044	4	4	500–4 Str.	5.28	2.28	3.04	3/8	3
	AMTS50045	4	5	500–4 Str.	6.44	2.28	3.04	3/8	2
	AMTS50046	4	6	500–4 Str.	7.59	2.28	3.04	3/8	2
	AMTS50047	4	7	500–4 Str.	8.75	2.28	3.04	3/8	2
AMTS50048	4	8	500–4 Str.	9.9	2.28	3.04	3/8	2	
	AMTS50049	4	9	500–4 Str.	11.06	2.28	3.04	3/8	2
	AMTS500410	4	10	500–4 Str.	12.22	2.28	3.04	3/8	1
	AMTS500411	4	11	500–4 Str.	13.37	2.28	3.04	3/8	1
	AMTS500412	4	12	500–4 Str.	14.53	2.28	3.04	3/8	1
	AMTS500413	4	13	500–4 Str.	15.68	2.28	3.04	3/8	1
	AMTS500414	4	14	500–4 Str.	16.84	2.28	3.04	3/8	1
	AMTS7502502	4	2	750–250	3.47	2.75	3.31	1/2	3
	AMTS7502503	4	3	750–250	4.89	2.75	3.31	1/2	3
	AMTS7502504	4	4	750–250	6.32	2.75	3.31	1/2	2
	AMTS7502505	4	5	750–250	7.74	2.75	3.31	1/2	1
	AMTS7502506	4	6	750–250	9.16	2.75	3.31	1/2	1
	AMTS7502507	4	7	750–250	10.58	2.75	3.31	1/2	1
	AMTS7502508	4	8	750–250	12	2.75	3.31	1/2	1
	AMTS7502509	4	9	750–250	13.43	2.75	3.31	1/2	1
AMTS75025010	4	10	750–250	14.85	2.75	3.31	1/2	1	
AMTS75025011	4	11	750–250	16.27	2.75	3.31	1/2	1	
AMTS75025012	4	12	750–250	17.69	2.75	3.31	1/2	1	
AMTS75025013	4	13	750–250	19.11	2.75	3.31	1/2	1	
AMTS75025014	4	14	750–250	20.54	2.75	3.31	1/2	1	

Fig. 5

Insulated multi-taps

AMT multi-port connector “double” both sides

AMT multi-port connector “double” both sides

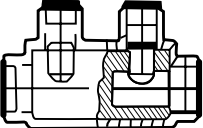
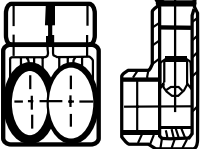
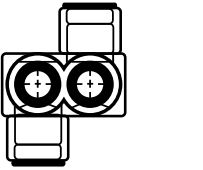

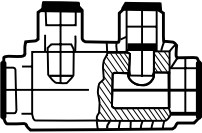
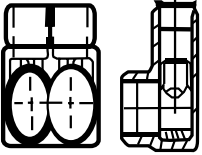
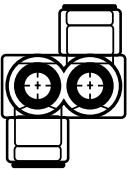
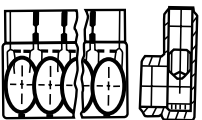
Diagrams	Cat. no.	Fig.	No. of ports	Wire range (AWG or kcmil)	Length (in.)	Width (in.)	Height (in.)	Hex size (in.)	Std. pkg. qty.
	AMTD4142	5	2	4–14 Str.	1.24	1.25	1.42	1/8	12
	AMTD4143	5	3	4–14 Str.	1.7	1.25	1.42	1/8	12
	AMTD4144	5	4	4–14 Str.	2.16	1.25	1.42	1/8	6
	AMTD4145	5	5	4–14 Str.	2.61	1.25	1.42	1/8	6
	AMTD4146	5	6	4–14 Str.	3.07	1.24	1.42	1/8	6
	AMTD4147	5	7	4–14 Str.	3.53	1.25	1.42	1/8	4
	AMTD4148	5	8	4–14 Str.	3.99	1.25	1.42	1/8	4
	AMTD4149	5	9	4–14 Str.	4.45	1.25	1.42	1/8	4
	AMTD41410	5	10	4–14 Str.	4.9	1.25	1.42	1/8	4
	AMTD41411	5	11	4–14 Str.	5.36	1.25	1.42	1/8	3
	AMTD41412	5	12	4–14 Str.	5.82	1.25	1.42	1/8	3
	AMTD41413	5	13	4–14 Str.	6.28	1.25	1.42	1/8	2
	AMTD41414	5	14	4–14 Str.	6.74	1.25	1.42	3/16	2
	AMTD10142	5	2	1/0–14 Str.	1.67	1.63	1.63	3/16	12
	AMTD10143	5	3	1/0–14 Str.	2.29	1.63	1.63	3/16	12
	AMTD10144	5	4	1/0–14 Str.	2.92	1.63	1.63	3/16	6
	AMTD10145	5	5	1/0–14 Str.	3.54	1.63	1.63	3/16	6
	AMTD10146	5	6	1/0–14 Str.	4.17	1.63	1.63	3/16	6
	AMTD10147	5	7	1/0–14 Str.	4.79	1.63	1.63	3/16	4
	AMTD10148	5	8	1/0–14 Str.	5.42	1.63	1.63	3/16	4
	AMTD10149	5	9	1/0–14 Str.	6.04	1.63	1.63	3/16	4
	AMTD101410	5	10	1/0–14 Str.	6.67	1.63	1.63	3/16	4
	AMTD101411	5	11	1/0–14 Str.	7.29	1.63	1.63	3/16	3
	AMTD101412	5	12	1/0–14 Str.	7.92	1.63	1.63	3/16	3
	AMTD101413	5	13	1/0–14 Str.	8.54	1.63	1.63	3/16	2
	AMTD101414	5	14	1/0–14 Str.	9.17	1.63	1.63	3/16	2
	AMTD3062	5	2	3/0–6 Str.	1.89	1.68	1.86	3/16	6
	AMTD3063	5	3	3/0–6 Str.	2.65	1.68	1.86	3/16	6
	AMTD3064	5	4	3/0–6 Str.	3.42	1.68	1.86	3/16	6
	AMTD3065	5	5	3/0–6 Str.	4.18	1.68	1.86	3/16	4
	AMTD3066	5	6	3/0–6 Str.	4.95	1.68	1.86	3/16	4
	AMTD3067	5	7	3/0–6 Str.	5.71	1.68	1.86	3/16	3
	AMTD3068	5	8	3/0–6 Str.	6.48	1.68	1.86	3/16	3
	AMTD3069	5	9	3/0–6 Str.	7.24	1.68	1.86	3/16	3
	AMTD30610	5	10	3/0–6 Str.	8.01	1.68	1.86	3/16	2
	AMTD30611	5	11	3/0–6 Str.	8.77	1.68	1.86	3/16	2
	AMTD30612	5	12	3/0–6 Str.	9.54	1.68	1.86	3/16	2
	AMTD30613	5	13	3/0–6 Str.	10.3	1.68	1.86	3/16	2
AMTD30614	5	14	3/0–6 Str.	11.07	1.68	1.86	3/16	2	
	AMTD25062	5	2	250–6 Str.	2.17	2.13	2.17	5/16	6
	AMTD25063	5	3	250–6 Str.	3.07	2.13	2.17	5/16	6
	AMTD25064	5	4	250–6 Str.	3.96	2.13	2.17	5/16	6
	AMTD25065	5	5	250–6 Str.	4.85	2.13	2.17	5/16	4
	AMTD25066	5	6	250–6 Str.	5.75	2.13	2.17	5/16	4
	AMTD25067	5	7	250–6 Str.	6.64	2.13	2.17	5/16	3
	AMTD25068	5	8	250–6 Str.	7.53	2.13	2.17	5/16	3
	AMTD25069	5	9	250–6 Str.	8.42	2.13	2.17	5/16	3
	AMTD250610	5	10	250–6 Str.	9.32	2.13	2.17	5/16	2

Continued on next page

Insulated multi-taps

AMT multi-port connector “double” both sides (continued)

AMT multi-port connector “double” both sides (continued)



Diagrams	Cat. no.	Fig.	No. of ports	Wire range (AWG or kcmil)	Length (in.)	Width (in.)	Height (in.)	Hex size (in.)	Std. pkg. qty.
	AMTD250611	5	11	250–6 Str.	10.21	2.13	2.17	$\frac{5}{16}$	2
	AMTD250612	5	12	250–6 Str.	11.1	2.13	2.17	$\frac{5}{16}$	2
	AMTD250613	5	13	250–6 Str.	12	2.13	2.17	$\frac{5}{16}$	1
	AMTD250614	5	14	250–6 Str.	12.89	2.13	2.17	$\frac{5}{16}$	1
	AMTD35062	5	2	350–6 Str.	2.51	2.25	2.62	$\frac{5}{16}$	4
	AMTD35063	5	3	350–6 Str.	3.56	2.25	2.62	$\frac{5}{16}$	4
	AMTD35064	5	4	350–6 Str.	4.61	2.25	2.62	$\frac{5}{16}$	3
	AMTD35065	5	5	350–6 Str.	5.67	2.25	2.62	$\frac{5}{16}$	3
	AMTD35066	5	6	350–6 Str.	6.71	2.25	2.62	$\frac{5}{16}$	3
	AMTD35067	5	7	350–6 Str.	7.76	2.25	2.62	$\frac{5}{16}$	2
	AMTD35068	5	8	350–6 Str.	8.81	2.25	2.62	$\frac{5}{16}$	2
	AMTD35069	5	9	350–6 Str.	9.86	2.25	2.62	$\frac{5}{16}$	2
	AMTD350610	5	10	350–6 Str.	10.91	2.25	2.62	$\frac{5}{16}$	2
	AMTD350611	5	11	350–6 Str.	11.96	2.25	2.62	$\frac{5}{16}$	1
	AMTD350612	5	12	350–6 Str.	13.01	2.25	2.62	$\frac{5}{16}$	1
	AMTD350613	5	13	350–6 Str.	14.06	2.25	2.62	$\frac{5}{16}$	1
	AMTD350614	5	14	350–6 Str.	15.11	2.25	2.62	$\frac{5}{16}$	1
	AMTD50042	5	2	500–4 Str.	2.97	2.63	3.04	$\frac{3}{8}$	3
	AMTD50043	5	3	500–4 Str.	4.12	2.63	3.04	$\frac{3}{8}$	3
	AMTD50044	5	4	500–4 Str.	5.28	2.63	3.04	$\frac{3}{8}$	3
	AMTD50045	5	5	500–4 Str.	6.44	2.63	3.04	$\frac{3}{8}$	2
	AMTD50046	5	6	500–4 Str.	7.59	2.63	3.04	$\frac{3}{8}$	2
	AMTD50047	5	7	500–4 Str.	8.75	2.63	3.04	$\frac{3}{8}$	2
	AMTD50048	5	8	500–4 Str.	9.9	2.63	3.04	$\frac{3}{8}$	2
	AMTD50049	5	9	500–4 Str.	11.06	2.63	3.04	$\frac{3}{8}$	2
	AMTD500410	5	10	500–4 Str.	12.22	2.63	3.04	$\frac{3}{8}$	1
	AMTD500411	5	11	500–4 Str.	13.37	2.63	3.04	$\frac{3}{8}$	1
	AMTD500412	5	12	500–4 Str.	14.53	2.63	3.04	$\frac{3}{8}$	1
	AMTD500413	5	13	500–4 Str.	15.68	2.63	3.04	$\frac{3}{8}$	1
	AMTD500414	5	14	500–4 Str.	16.84	2.63	3.04	$\frac{3}{8}$	1
	AMTD7502502	5	2	750–250	3.47	3.25	3.31	$\frac{1}{2}$	3
	AMTD7502503	5	3	750–250	4.89	3.25	3.31	$\frac{1}{2}$	3
	AMTD7502504	5	4	750–250	6.32	3.25	3.31	$\frac{1}{2}$	2
	AMTD7502505	5	5	750–250	7.74	3.25	3.31	$\frac{1}{2}$	1
	AMTD7502506	5	6	750–250	9.16	3.25	3.31	$\frac{1}{2}$	1
	AMTD7502507	5	7	750–250	10.58	3.25	3.31	$\frac{1}{2}$	1
	AMTD7502508	5	8	750–250	12	3.25	3.31	$\frac{1}{2}$	1
	AMTD7502509	5	9	750–250	13.43	3.25	3.31	$\frac{1}{2}$	1
	AMTD75025010	5	10	750–250	14.85	3.25	3.31	$\frac{1}{2}$	1
	AMTD75025011	5	11	750–250	16.27	3.25	3.31	$\frac{1}{2}$	1
	AMTD75025012	5	12	750–250	17.69	3.25	3.31	$\frac{1}{2}$	1
	AMTD75025013	5	13	750–250	19.11	3.25	3.31	$\frac{1}{2}$	1
	AMTD75025014	5	14	750–250	20.54	3.25	3.31	$\frac{1}{2}$	1
	AMTDM3062	5	2	3/0–6 Str.	3.42	1.68	1.86	$\frac{3}{16}$	6
	AMTDM3063	5	3	3/0–6 Str.	4.18	1.68	1.86	$\frac{3}{16}$	4
	AMTDM3064	5	4	3/0–6 Str.	4.95	1.68	1.86	$\frac{3}{16}$	4
	AMTDM3065	5	5	3/0–6 Str.	5.71	1.68	1.86	$\frac{3}{16}$	3
	AMTDM3066	5	6	3/0–6 Str.	6.48	1.68	1.86	$\frac{3}{16}$	3

Continued on next page

Insulated multi-taps

AMT multi-port connector “double” both sides (continued)

AMT multi-port connector “double” both sides (continued)



	Cat. no.	Fig.	No. of ports	Wire range (AWG or kcmil)	Length (in.)	Width (in.)	Height (in.)	Hex size (in.)	Std. pkg. qty.
Diagrams	AMTDM3067	5	7	3/0–6 Str.	7.24	1.68	1.86	3/16	3
	AMTDM3068	5	8	3/0–6 Str.	8.01	1.68	1.86	3/16	2
	AMTDM3069	5	9	3/0–6 Str.	8.77	1.68	1.86	3/16	2
	AMTDM30610	5	10	3/0–6 Str.	9.54	1.68	1.86	3/16	2
	AMTDM30611	5	11	3/0–6 Str.	10.3	1.68	1.86	3/16	2
	AMTDM30612	5	12	3/0–6 Str.	11.07	1.68	1.86	3/16	2
	AMTDM25062	5	2	250–6 Str.	3.96	2.13	2.17	5/16	6
	AMTDM25063	5	3	250–6 Str.	4.85	2.13	2.17	5/16	4
	AMTDM25064	5	4	250–6 Str.	5.73	2.13	2.17	5/16	4
	AMTDM25065	5	5	250–6 Str.	6.64	2.13	2.17	5/16	3
	AMTDM25066	5	6	250–6 Str.	7.53	2.13	2.17	5/16	3
	AMTDM25067	5	7	250–6 Str.	8.42	2.13	2.17	5/16	3
Fig. 1	AMTDM25068	5	8	250–6 Str.	9.32	2.13	2.17	5/16	2
	AMTDM25069	5	9	250–6 Str.	10.21	2.13	2.17	5/16	2
	AMTDM250610	5	10	250–6 Str.	11.1	2.13	2.17	5/16	2
	AMTDM250611	5	11	250–6 Str.	12	2.13	2.17	5/16	1
	AMTDM250612	5	12	250–6 Str.	12.89	2.13	2.17	5/16	1
	AMTDM35062	5	2	350–6 Str.	4.61	2.25	2.62	5/16	3
	AMTDM35063	5	3	350–6 Str.	5.67	2.25	2.62	5/16	3
	AMTDM35064	5	4	350–6 Str.	6.71	2.25	2.62	5/16	3
	AMTDM35065	5	5	350–6 Str.	7.76	2.25	2.62	5/16	2
	AMTDM35066	5	6	350–6 Str.	8.81	2.25	2.62	5/16	2
	AMTDM35067	5	7	350–6 Str.	9.86	2.25	2.62	5/16	2
	AMTDM35068	5	8	350–6 Str.	10.91	2.25	2.62	5/16	2
Fig. 2	AMTDM35069	5	9	350–6 Str.	11.96	2.25	2.62	5/16	1
	AMTDM350610	5	10	350–6 Str.	13.01	2.25	2.62	5/16	1
	AMTDM350611	5	11	350–6 Str.	14.06	2.25	2.62	5/16	1
	AMTDM350612	5	12	350–6 Str.	15.11	2.25	2.62	5/16	1
	AMTDM50042	5	2	500–4 Str.	5.25	2.63	3.04	3/8	3
	AMTDM50043	5	3	500–4 Str.	6.44	2.63	3.04	3/8	2
	AMTDM50044	5	4	500–4 Str.	7.59	2.63	3.04	3/8	2
	AMTDM50045	5	5	500–4 Str.	8.75	2.63	3.04	3/8	2
	AMTDM50046	5	6	500–4 Str.	9.9	2.63	3.04	3/8	2
	AMTDM50047	5	7	500–4 Str.	11.06	2.63	3.04	3/8	2
	AMTDM50048	5	8	500–4 Str.	12.22	2.63	3.04	3/8	1
	AMTDM50049	5	9	500–4 Str.	13.37	2.63	3.04	3/8	1
Fig. 3	AMTDM500410	5	10	500–4 Str.	14.53	2.63	3.04	3/8	1
	AMTDM500411	5	11	500–4 Str.	15.68	2.63	3.04	3/8	1
	AMTDM500412	5	12	500–4 Str.	16.84	2.63	3.04	3/8	1
	AMTDM7502502	5	2	750–250	6.32	3.25	3.31	1/2	2
	AMTDM7502503	5	3	750–250	7.74	3.25	3.31	1/2	1
	AMTDM7502504	5	4	750–250	9.16	3.25	3.31	1/2	1
	AMTDM7502505	5	5	750–250	10.58	3.25	3.31	1/2	1
	AMTDM7502506	5	6	750–250	12	3.25	3.31	1/2	1
	AMTDM7502507	5	7	750–250	13.43	3.25	3.31	1/2	1
	AMTDM7502508	5	8	750–250	14.85	3.25	3.31	1/2	1
	AMTDM7502509	5	9	750–250	16.27	3.25	3.31	1/2	1
	Fig. 4	AMTDM75025010	5	10	750–250	17.69	3.25	3.31	1/2
AMTDM75025011		5	11	750–250	19.11	3.25	3.31	1/2	1
AMTDM75025012		5	12	750–250	20.54	3.25	3.31	1/2	1
AMTDM75025012		5	12	750–250	20.54	3.25	3.31	1/2	1

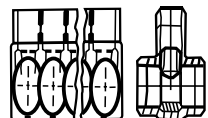

Fig. 5

Power distribution blocks

Blackburn® power distribution blocks are suitable for all panel building applications and various terminal enclosure solutions; for extending or branching the cables or changing the conductor type.



Features

- Insulated housing provides fast, clean, safe installation and controlled dielectric strength
- Grooved contact surfaces penetrate conductor oxides for best contact
- Easily installed and position-locked with DIN rail or screw mounting

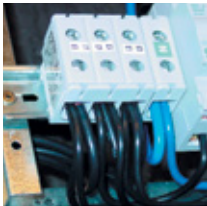

Typical applications

- Ideal for OEM use in electrical, electronics, panel, switchboard, switchgear, automation and control manufacturing
- Also suitable for industrial/commercial retrofit contractors, installation technicians, maintenance and service providers
- Use in distribution panels, control boxes, automation products, ESS centers and more



Specifications

- Max. voltage: 600 V
- Max. temperature: 80 °C
- Flammability rating: V-2 (UL94)
- Standards & testing: UL1059, Category XCFR2, file number E66436; SFS 2663; VDE 0220, Teil 1/11.71, Teil 2/11.71, SEN 241510, SEN 245012; IEC 61238 Class B

Terminal blocks

- One-pole feedthrough terminal blocks
- Three-pole version (Cat. No. PDS3610) supports three-phase systems
- Designed for connecting or extending both aluminum and copper conductors

Tapping blocks

- One pole, four identical terminals
- Suitable for extending or branching both aluminum and copper conductors
- Standard catalog no. is gray (add B suffix for blue or G suffix for green/yellow)

— 01 Terminal blocks

— 02 Tapping blocks



— 01

— 02

Power distribution blocks

Conductor table









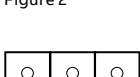
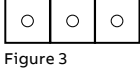

Conductors that can be used with the power distribution blocks – Number, cross-section and type.

- Requirements of a specific apparatus may restrict the number of conductors
- Usually a maximum of three adjacent standard cross-sections in one space
- In general, the conductors connected to one conductor space of a connector must be of the same type
- Table values require careful installation
- We recommend use of ferrules when using fine-stranded conductors
- After installation, check that all conductors are pressed into a connection

- The nominal current of the power distribution blocks must not be exceeded
- According to some installation standards, each incoming and outgoing protection and neutral conductor in a panel must have its own separate power distribution blocks
- The conductor numbers below refer only to industrially installed power distribution blocks (internal connections in a panel)

Cross-sections of conductors (AWG/kcmil) and number of conductors/space. The conductor numbers below refer only to industrially installed.

Conductor table

	Cat. no.	AWG/kcmil	8	6	4	3	2	1	1/0	2/0	3/0	4/0	250	300	350	400	500	Figure
	PDS610	Al	–	1	1	1	1	1	–	–	–	–	–	–	–	–	–	1
		Cu	–	1	1	1	1	1	–	–	–	–	–	–	–	–	–	
		Cu	–	2	–	–	–	–	–	–	–	–	–	–	–	–	–	
		Cu	3	–	–	–	–	–	–	–	–	–	–	–	–	–	–	
	PDS3610	Al	–	1	1	1	1	1	–	–	–	–	–	–	–	–	–	3
		Cu	–	1	1	1	1	1	–	–	–	–	–	–	–	–	–	
		Cu	–	2	–	–	–	–	–	–	–	–	–	–	–	–	–	
	PDS440	Al	–	–	1	1	1	1	1	1	1	1	–	–	–	–	–	1
		Cu	–	–	1	1	1	1	1	1	1	1	1	–	–	–	–	
		Cu	–	2	2	2	2	–	–	–	–	–	–	–	–	–	–	
	PDS2300	Al	–	–	–	–	1	1	1	1	1	1	1	1	–	–	–	2
		Cu	–	–	–	–	1	1	1	1	1	1	1	1	–	–	–	
		Cu	–	–	–	–	2	2	2	–	–	–	–	–	–	–	–	
	PDS30500	Al	–	–	–	–	–	–	–	–	1	1	1	1	1	1	1	1
		Cu	–	–	–	–	–	–	–	–	1	1	1	1	1	1	1	
		Cu	–	–	–	–	2	2	2	2	–	–	–	–	–	–	–	
	PDS2610	Al	–	1	1	1	1	1	–	–	–	–	–	–	–	–	–	2
		Cu	–	1	1	1	1	1	–	–	–	–	–	–	–	–	–	
		Cu	–	2	–	–	–	–	–	–	–	–	–	–	–	–	–	
	PDS2440	Al	–	–	1	1	1	1	1	1	1	1	–	–	–	–	–	2
		Cu	–	–	1	1	1	1	1	1	1	1	1	–	–	–	–	
		Cu	–	2	2	2	2	–	–	–	–	–	–	–	–	–	–	
	PDS22300	Al	–	–	–	–	1	1	1	1	1	1	1	1	–	–	–	2
		Cu	–	–	–	–	1	1	1	1	1	1	1	1	–	–	–	
		Cu	–	–	–	–	2	2	2	–	–	–	–	–	–	–	–	
	PDS230500	Al	–	–	–	–	–	–	–	–	1	1	1	1	1	1	1	2
		Cu	–	–	–	–	–	–	–	–	1	1	1	1	1	1	1	
		Cu	–	–	–	–	2	2	2	2	–	–	–	–	–	–	–	
	PDS230500	Al	–	–	–	–	–	–	–	–	1	1	1	1	1	1	1	2
		Cu	–	–	–	–	–	–	–	–	1	1	1	1	1	1	1	
		Cu	–	–	–	–	2	2	2	2	–	–	–	–	–	–	–	
	PDS230500	Al	–	–	–	–	–	–	–	–	1	1	1	1	1	1	1	2
		Cu	–	–	–	–	–	–	–	–	1	1	1	1	1	1	1	
		Cu	–	–	–	–	2	2	2	2	–	–	–	–	–	–	–	
	PDS230500	Al	–	–	–	–	–	–	–	–	1	1	1	1	1	1	1	2
		Cu	–	–	–	–	–	–	–	–	1	1	1	1	1	1	1	
		Cu	–	–	–	–	2	2	2	2	–	–	–	–	–	–	–	
	PDS230500	Al	–	–	–	–	–	–	–	–	1	1	1	1	1	1	1	2
		Cu	–	–	–	–	–	–	–	–	1	1	1	1	1	1	1	
		Cu	–	–	–	–	2	2	2	2	–	–	–	–	–	–	–	

Power distribution blocks

Power distribution blocks

Cat. no.	Wire range (AWG or kcmil, Cu or Al)	Max. current (A Cu/A Al)	Tightening torque (lb.-in.)	Allen hex socket head terminal screw (mm)	Mounting	Overall dimensions (in.)	Color	Pkg. qty.
Terminal blocks								
PDS610	1/0 – 6	150/120	90	5	Top hat rail	0.7 W x 1.9 H x 1.7 D	Gray	30
PDS610B	1/0 – 6	150/120	90	5	Top hat rail	0.7 W x 1.9 H x 1.7 D	Blue	30
PDS610G	1/0 – 6	150/120	90	5	Top hat rail	0.7 W x 1.9 H x 1.7 D	Yellow Green	30
PDS3610	1/0 – 6	150/120	90	5	Top hat rail	1.9 W x 1.9 H x 1.7 D	Gray	30
PDS440	4/0 – 4	230/180	126	5	Top hat rail or screw	0.9 W x 3.4 H x 1.9 D	Gray	30
PDS440B	4/0 – 4	230/180	126	5	Top hat rail or screw	0.9 W x 3.4 H x 1.9 D	Blue	30
PDS440G	4/0 – 4	230/180	126	5	Top hat rail or screw	0.9 W x 3.4 H x 1.9 D	Yellow Green	30
PDS2300	300 – 2	285/230	216	8	Top hat rail or screw	1.2 W x 3.7 H x 2.3 D	Gray	30
PDS2300B	300 – 2	285/230	216	8	Top hat rail or screw	1.2 W x 3.7 H x 2.3 D	Blue	30
PDS2300G	300 – 2	285/230	216	8	Top hat rail or screw	1.2 W x 3.7 H x 2.3 D	Yellow Green	30
PDS30500	500 – 3/0	380/310	360	8	Screw	1.5 W x 5.1 H x 2.6 D	Gray	30
PDS30500B	500 – 3/0	380/310	360	8	Screw	1.5 W x 5.1 H x 2.6 D	Blue	30
PDS30500G	500 – 3/0	380/310	360	8	Screw	1.5 W x 5.1 H x 2.6 D	Yellow Green	30
Tapping blocks								
PDS2610	1/0 – 6	150/120	90	5	Top hat rail	1.2 W x 1.9 H x 1.7 D	Gray	30
PDS2610B	1/0 – 6	150/120	90	5	Top hat rail	1.2 W x 1.9 H x 1.7 D	Blue	30
PDS2610G	1/0 – 6	150/120	90	5	Top hat rail	1.2 W x 1.9 H x 1.7 D	Yellow Green	30
PDS2440	4/0 – 4	230/180	126	5	Top hat rail or screw	1.7 W x 3.4 H x 1.9 D	Gray	30
PDS2440B	4/0 – 4	230/180	126	5	Top hat rail or screw	1.7 W x 3.4 H x 1.9 D	Blue	30
PDS2440G	4/0 – 4	230/180	126	5	Top hat rail or screw	1.7 W x 3.4 H x 1.9 D	Yellow Green	30
PDS22300	300 – 2	285/230	216	8	Top hat rail or screw	2 W x 3.7 H x 2.3 D	Gray	30
PDS22300B	300 – 2	285/230	216	8	Top hat rail or screw	2 W x 3.7 H x 2.3 D	Blue	30
PDS22300G	300 – 2	285/230	216	8	Top hat rail or screw	2 W x 3.7 H x 2.3 D	Yellow Green	30
PDS230500	500 – 3/0	380/310	360	8	Screw	2.5 W x 5.1 H x 2.6 D	Gray	30
PDS230500B	500 – 3/0	380/310	360	8	Screw	2.5 W x 5.1 H x 2.6 D	Blue	30
PDS230500G	500 – 3/0	380/310	360	8	Screw	2.5 W x 5.1 H x 2.6 D	Yellow Green	30

Dual-rated mechanical connectors

Anti-rotational connectors



“No-turn” design keeps connector securely in place – Even under vibration.

Blackburn® anti-rotational connectors are designed with a rib on the bottom that keeps the connectors from turning, so there’s no need to apply excessive torque and there’s no danger of loosening connectors.

The unique “no-turn” rib provides a secure connection that eliminates the conductor pinching that results from connector movement.

The “no-turn” design solves a unique problem for electricians and installers. Larger conductors tend to get damaged in over-torque conditions, and connectors are prone to loosen in applications where there is vibration, such as motor loads.

Inspectors and local standards boards are requiring electricians and installers to make provisions to eliminate these conditions, and Blackburn anti-rotational connectors are the solution.

- Unique bottom rib keeps connector from turning
- Eliminates the need for excessive torque, which can damage large conductors
- Prevents connector loosening, even in heavy-vibration applications

Anti-rotational connectors



Diagrams	Cat. no.	Wire range (AWG or kcmil)	Bolt hole (in.)	Dimensions (in.)										Fig.
				A	B	C	D	E	F	G	H	M	N	
	ADR21-AR	2/0-14	¼	1.470	0.600	0.790	0.190	0.200	0.438	0.094	0.620	0.267	0.453	1
	ADR30-AR	300-6	7/16	2.000	1.000	1.120	0.250	0.200	0.468	0.094	1.000	0.330	0.656	1
	ADR35-AR	350-6	5/16	2.250	1.120	1.125	0.250	0.200	0.485	0.094	1.120	0.408	0.719	1
	ADR60-AR	600-2	½	3.120	1.500	1.560	0.440	0.200	0.720	0.094	1.380	0.408	0.938	1
	ADR35-21-AR	350-6	3/8	2.880	1.500	1.250	0.250	0.200	0.875	0.094	1.120	0.563	0.719	2
	ADR60-21-AR	600-2	½	3.120	2.400	1.560	0.440	0.200	0.555	0.094	1.380	0.531	0.938	2

Fig. 1

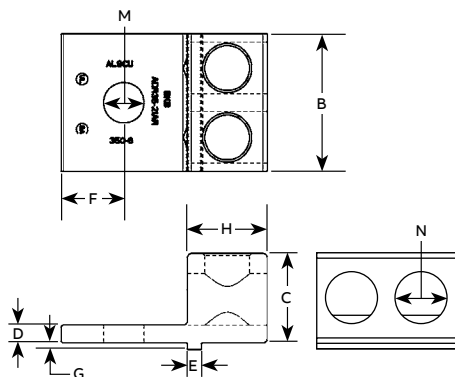

Fig. 2

Dual-rated mechanical connectors

Type ADR – ALCÜL™ single-conductor, one-hole mount and two-hole mount



- All-aluminum-body lugs for use on copper and aluminum conductors
- Easy installation – No special tools required
- Tin plated for low contact resistance

Type ADR – ALCÜL single-conductor, one-hole mount*



Cat. no.	Conductor range AWG or kcmil (Al or Cu)		Dimensions (in.)							
	Max.	Min.	L	W	H	D	E	F	G	
Diagrams										
Slotted screw										
ADR6	#6 Str.	#14	1 ³ / ₆₄	1/2	3 ¹ / ₆₄	1 ⁵ / ₆₄	1/4	5/64	4 ³ / ₆₄	
ADR2	#2 Str.	#14	1 ⁵ / ₃₂	1/2	9/16	1 ⁹ / ₆₄	1/4	7/64	1 ¹ / ₁₆	
ADR11	1/0 Str.	#14	1 ¹⁵ / ₃₂	5/8	2 ⁵ / ₃₂	7/16	1/4	3/16	2 ⁷ / ₃₂	
ADR21	2/0 Str.	#14	1 ¹⁵ / ₃₂	5/8	2 ⁵ / ₃₂	7/16	1/4	3/16	2 ⁷ / ₃₂	
Socket screw										
ADR25	250	#6 Str.	2	1	1 ¹ / ₈	1 ⁵ / ₃₂	5/16	1/4	1	
ADR30	300	#6 Str.	2	1	1 ¹ / ₈	1 ⁵ / ₃₂	5/16	1/4	1	
ADR35	350	#6 Str.	2 ¹ / ₄	1 ¹ / ₈	1 ¹ / ₄	1/2	3/8	1/4	1 ¹ / ₈	
ADR50	500	#4 Str.	2 ¹³ / ₁₆	1 ¹ / ₂	1 ⁹ / ₁₆	3/4	3/8	5/16	1 ¹⁹ / ₃₂	
ADR60	600	#2 Str.	3 ³ / ₁₆	1 ¹ / ₂	1 ⁹ / ₁₆	1 ³ / ₁₆	3/8	7/16	1 ¹³ / ₁₆	
ADR6004*	600	#4 Str.	2 ¹³ / ₁₆	1 ³ / ₈	1 ¹³ / ₁₆	5/8	3/8	5/16	1 ¹ / ₂	
	(2) 250	(2) 1/0 Str.								
ADR80	800	300	3 ³ / ₈	1 ³ / ₄	1 ¹⁵ / ₁₆	5/8	5/8	1/2	1 ³ / ₄	
ADR99	1000	500	3 ³ / ₈	1 ³ / ₄	1 ¹⁵ / ₁₆	5/8	5/8	1/2	1 ³ / ₄	

* Not UL® listed or CSA certified.



- UL 486B tested, AL9CU rated
- Slotted screw on lugs up through 2/0 str.; 5/16" socket screw on sizes 250 through 350 kcmil; 3/8" hex socket on sizes 500 kcmil and above

Type ADR – ALCÜL single-conductor, two-hole mount*



Cat. no.	Conductor range AWG or kcmil (Al or Cu)		Dimensions (in.)							
	Max.	Min.	L	W	H	D	E	F	G	
Diagrams										
ADR35-12#	350	6 Str.	4 ¹ / ₄	1 ¹ / ₄	1 ³ / ₈	5/8	1/2	5/16	3	
ADR60-12D	600	2 Str.	5 ⁵ / ₁₆	1 ¹ / ₂	1 ¹ / ₂	5/8	1/2	3/8	3 ¹ / ₁₆	
ADR80-12D	800	300	6 ³ / ₁₆	1 ³ / ₄	1 ⁷ / ₈	5/8	1/2	9/16	3 ⁷ / ₁₆	
ADR99-12D	1,000	500	6 ³ / ₁₆	1 ³ / ₄	1 ⁷ / ₈	5/8	1/2	9/16	3 ⁷ / ₁₆	

* NEMA spacing: 1³/₄" centers

UL listed. Connectors accommodating conductors 600 kcmil and larger have double row of set screws (D suffix).

Dual-rated mechanical connectors

Type ADR – ALCÜL™ single-conductor, switchgear mount and two-conductor, one-hole mount

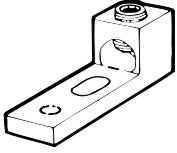

Type ADR – ALCÜL™ single-conductor, switchgear mount*



Cat. no.	Conductor range (AWG or kcmil, Al or Cu)		Dimensions (in.)						
	Max.	Min.	L	W	H	D	E	F	G
ADR25-12S	250	3/0 Str.	3	1	$1\frac{3}{16}$	$\frac{1}{2}$	$\frac{3}{8}$	$\frac{1}{4}$	2
ADR35-12S	350	4 Str.	$4\frac{1}{16}$	$1\frac{1}{4}$	$1\frac{9}{16}$	$\frac{23}{32}$	$\frac{1}{2}$	$\frac{7}{16}$	$3\frac{5}{16}$
ADR50-12S	500	400	$4\frac{1}{16}$	$1\frac{1}{4}$	$1\frac{9}{16}$	$\frac{23}{32}$	$\frac{1}{2}$	$\frac{7}{16}$	$3\frac{5}{16}$
ADR80-12DS	800	300	$6\frac{3}{16}$	$1\frac{5}{8}$	$1\frac{7}{8}$	$\frac{23}{32}$	$\frac{1}{2}$	$\frac{9}{16}$	$3\frac{7}{16}$
ADR99-12DS	1,000	350	$6\frac{3}{16}$	$1\frac{5}{8}$	$1\frac{7}{8}$	$\frac{23}{32}$	$\frac{1}{2}$	$\frac{9}{16}$	$3\frac{7}{16}$

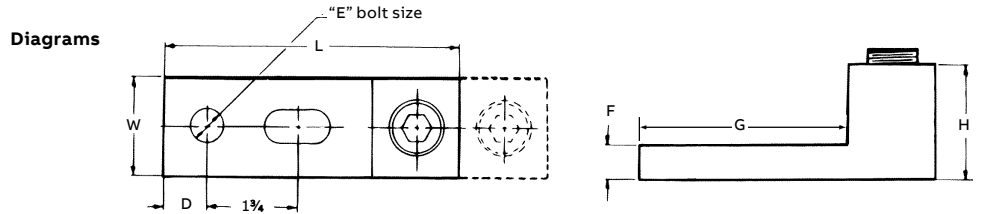

* NEMA spacing: $1\frac{3}{4}$ " centers except ADR25-12S: 1" centers.

Connectors accommodating conductors 600 kcmil and larger have double row of set screws (D suffix).



Type ADR – ALCÜL™ two-conductor, one-hole mount



Cat. no.	Conductor range (AWG or kcmil, Al or Cu)		Dimensions (in.)							
	Max.	Min.	L	W	H	D	E	F	G	I
ADR11-21	1/0 Str.	#14	$1\frac{15}{32}$	$1\frac{7}{32}$	$\frac{25}{32}$	$\frac{7}{16}$	$\frac{1}{4}$	$\frac{3}{16}$	$\frac{27}{32}$	$\frac{35}{64}$
ADR21-21*	2/0 Str.	#14	$1\frac{15}{32}$	$1\frac{1}{4}$	$\frac{25}{32}$	$\frac{27}{64}$	$\frac{1}{4}$	$\frac{3}{16}$	$\frac{27}{32}$	$\frac{21}{32}$
ADR25-21	250	#6 Str.	$2\frac{9}{16}$	$1\frac{41}{64}$	$1\frac{3}{16}$	$\frac{7}{8}$	$\frac{3}{8}$	$\frac{1}{4}$	$1\frac{9}{16}$	$\frac{13}{16}$
ADR35-21	350	#6 Str.	$2\frac{7}{8}$	$1\frac{59}{64}$	$1\frac{1}{4}$	$\frac{7}{8}$	$\frac{1}{2}$	$\frac{1}{4}$	$1\frac{3}{4}$	$\frac{61}{64}$
ADR60-21	600	#2 Str.	$3\frac{3}{16}$	$2\frac{13}{32}$	$1\frac{9}{16}$	$\frac{5}{8}$	$\frac{1}{2}$	$\frac{7}{16}$	$1\frac{13}{16}$	$1\frac{7}{32}$
ADR80-21	800	300	$3\frac{3}{8}$	$3\frac{3}{16}$	$1\frac{15}{16}$	$\frac{7}{8}$	$\frac{5}{8}$	$\frac{1}{2}$	$1\frac{3}{4}$	$1\frac{5}{8}$
ADR99-21	1000	500	$3\frac{3}{8}$	$3\frac{3}{16}$	$1\frac{15}{16}$	$\frac{7}{8}$	$\frac{5}{8}$	$\frac{1}{2}$	$1\frac{3}{4}$	$1\frac{5}{8}$

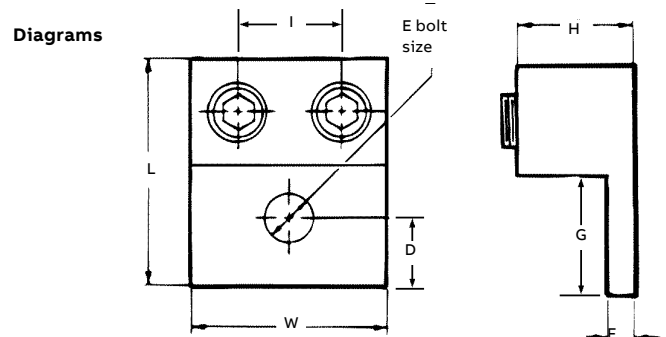

* Not CSA certified. UL® 486B, AL9CU

Dual-rated mechanical connectors

Type ADR – ALCÜL™ two- and three-conductor, two-hole mount

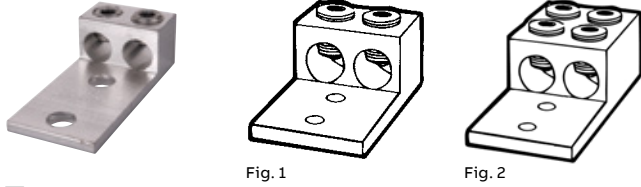

Fig. 1

Fig. 2

Type ADR – ALCÜL two-conductor, two-hole mount*



Cat. no.	Fig.	Conductor range (AWG or kcmil, Al or Cu)				Dimensions (in.)						
		Max.	Min.	L	W	H	D	E	F	G	I	
ADR35-22	1	350	6 Str.	4 1/4	2 19/64	1 3/8	5/8	1/2	5/16	3	1 1/32	
ADR60-22D	2	600	2 Str.	5 5/16	2 3/4	1 1/2	5/8	1/2	3/8	3 1/16	1 1/16	
ADR80-22D	2	800	300	6 3/16	3 1/2	1 7/8	5/8	1/2	9/16	3 1/16	1 13/16	
ADR99-22D	2	1,000	500	6 3/16	3 1/2	1 7/8	5/8	1/2	9/16	3 1/16	1 13/16	

Diagrams

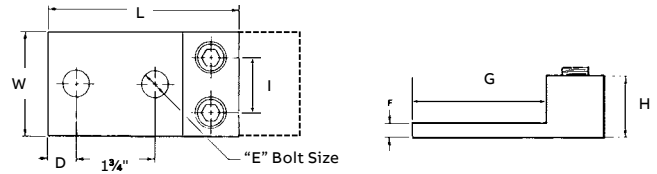

* NEMA spacing: 1 3/4" centers.

Connectors accommodating conductors 600 kcmil and larger have double row of set screws (D suffix).

UL 486B, AL9CU

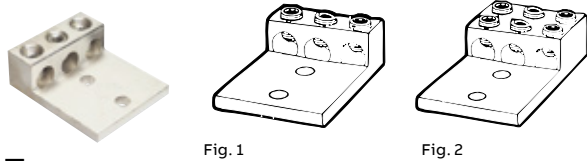

Fig. 1

Fig. 2

Type ADR – ALCÜL three-conductor, two-hole mount*



Cat. no.	Fig.	Conductor range (AWG or kcmil, Al or Cu)				Dimensions (in.)						
		Max.	Min.	L	W	H	D	E	F	G	I	
ADR02-32	1	2 Str.	14 AWG	2 3/16	1 5/8	5/8	1 1/32	5/16	3/16	1 11/16	9/16	
ADR11-32	1	1/0 Str.	14 AWG	2 29/32	2	7/8	1 1/32	3/8	1/4	2 5/32	4 5/64	
ADR31-32	1	3/0 Str.	6 Str.	4	2 13/16	1 3/16	5/8	1/2	5/16	3	3 1/32	
ADR25-32	1	250	6 Str.	4 3/16	2 13/16	1 1/4	5/8	1/2	1/4	3 1/16	3 1/32	
ADR35-32	1	350	6 Str.	4 3/16	3 3/16	1 1/4	5/8	1/2	1/4	3 1/16	1 1/32	
ADR50-32	1	500	4 Str.	4 11/16	3 3/4	1 9/16	5/8	1/2	7/16	3 5/16	1 1/4	
ADR60-32D	2	600	2 Str.	5 5/16	4 3/16	1 1/2	5/8	1/2	3/8	3 1/16	1 7/16	
ADR80-32	2	800	300	6 3/16	4 1/2	1 7/8	5/8	1/2	9/16	3 7/16	1 9/16	
ADR99-32	2	1,000	500	6 3/16	4 3/4	1 7/8	5/8	1/2	9/16	3 7/16	1 41/64	

Diagrams

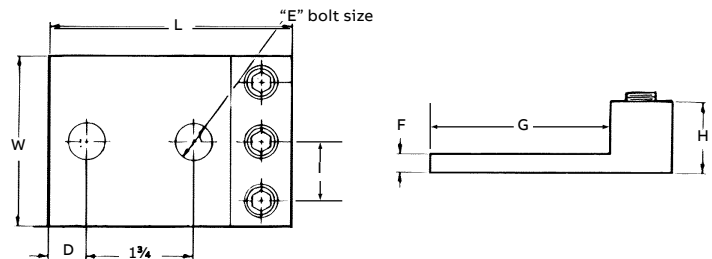

* NEMA spacing: 1 3/4" centers except ADR02-32 (7/8" centers) and ADR11-32 (1" centers).

Connectors accommodating conductors 600 kcmil and larger have double row of set screws (D suffix).

UL 486B, AL9CU

Dual-rated mechanical connectors

Type ADR – ALCÜL™ three- and four-conductor, four-hole mount



Fig. 1

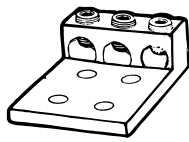

Fig. 2

Type ADR – ALCÜL three-conductor, four-hole mount**



Diagrams	Cat. no.	Fig.	Conductor range (AWG or kcmil, Al or Cu)				Dimensions (in.)						
			Max.	Min.	L	W	H	D	E	F	G	I	
	ADR02-34	1	2 Str.	14	2 ³ / ₁₆	1 ⁵ / ₈	5/ ₈	1 ¹ / ₃₂	5/ ₁₆	3/ ₁₆	1 ¹¹ / ₁₆	9/ ₁₆	
	ADR11-34	1	1/0 Str.	14	2 ²⁹ / ₃₂	2	7/ ₈	1 ¹ / ₃₂	3/ ₈	1/ ₄	2 ⁵ / ₃₂	4 ⁵ / ₆₄	
	ADR31-34	1	3/0 Str.	6 Str.	6	2 ¹³ / ₁₆	1 ³ / ₁₆	5/ ₈	1/ ₂	5/ ₁₆	3	3 ¹ / ₃₂	
	ADR25-34*	1	250	6 Str.	4 ³ / ₁₆	2 ¹³ / ₁₆	1 ¹ / ₄	5/ ₈	1/ ₂	1/ ₄	3 ¹ / ₁₆	3 ¹ / ₃₂	
	ADR35-34*	1	350	6 Str.	4 ³ / ₁₆	3 ³ / ₁₆	1 ¹ / ₄	5/ ₈	1/ ₂	1/ ₄	3 ¹ / ₁₆	1 ¹ / ₃₂	
	ADR50-34*	1	500	2 Str.	4 ¹¹ / ₁₆	3 ³ / ₄	1 ⁹ / ₁₆	5/ ₈	1/ ₂	7/ ₁₆	3 ⁵ / ₁₆	1 ¹ / ₄	
	ADR60-34D	2	600	2 Str.	5 ⁵ / ₁₆	4 ³ / ₁₆	1 ¹ / ₂	5/ ₈	1/ ₂	3/ ₈	3 ¹ / ₁₆	1 ⁷ / ₁₆	
	ADR80-34*	2	800		300	6 ³ / ₁₆	4 ¹ / ₂	1 ⁷ / ₈	5/ ₈	1/ ₂	9/ ₁₆	3 ⁷ / ₁₆	1 ⁹ / ₁₆
	ADR99-34*	2	1,000		500	6 ³ / ₁₆	4 ³ / ₄	1 ⁷ / ₈	5/ ₈	1/ ₂	9/ ₁₆	3 ⁷ / ₁₆	1 ⁴¹ / ₆₄

* UL® listed.

** NEMA spacing: 1³/₄" centers except ADR02-34 (7/₈" centers) and ADR11-34 (1" centers).
Connectors accommodating conductors 600 kcmil and larger have double row of set screws.
UL 486B, AL9CU



Fig. 1



Fig. 2

Type ADR – ALCÜL four-conductor, four-hole mount*



Diagrams	Cat. no.	Conductor range (AWG or kcmil, Al or Cu)				Mounting holes	G	F	
		Max.	Min.	L	W				H
	ADR25-44	250	#6	4.00	4.06	1.19	1.75	3.00	0.31
	ADR35-44	350	#6	4.31	3.94	1.38	1.75	3.00	0.31
	ADR60-44D	600	#2	5.50	5.00	1.50	1.75	3.25	0.38
	ADR80-44D	800		350	5.97	6.00	1.81	1.75	3.63

* NEMA spacing: 1³/₄" centers.

Connectors accommodating conductors 600 kcmil and larger have double row of set screws (D suffix).

Dual-rated mechanical connectors

Type ASL – ALCÜL two-conductor, one-hole mount
and Type ASL – ALCÜL™ two-, and three-conductor, two-hole mount



Type ASL – ALCÜL two-conductor, one-hole mount



Diagrams	Cat. no.	Conductor range (AWG or kcmil, Al or Cu)			Dimensions (in.)					Mtg. hole dia.
		Max.	Min.	L	W	H	D	F		
	ASL30-21	300	6 Str.	3	1 1/8	2	15/32	1/2	5/16	



Type ASL – ALCÜL two-conductor, two-hole mount



Diagrams	Cat. no.	Conductor range (AWG or kcmil, Al or Cu)			Dimensions (in.)				
		Max.	Min.	L	W	H	D	F	
	ASL60-22	600	2 Str.	4 ^{29/32}	1 1/2	3	3/4	3/8	
	ASL75-22	750	3/0 Str.	4 ^{29/32}	1 1/2	3	3/4	3/8	

UL® 486B
AL9CU



Type ASL – ALCÜL three-conductor, two-hole mount



Diagrams	Cat. no.	Conductor range (AWG or kcmil, Al or Cu)			Dimensions (in.)				
		Max.	Min.	L	W	H	D	F	I
	ASL60-32	600	2 Str.	4 ^{29/32}	2 1/2	3	3/4	3/8	1 1/32
	ASL75-32	750	3/0 Str.	4 ^{29/32}	2 ^{27/21}	3	3/4	3/8	1 5/16

Dual-rated mechanical connectors

Type ASL – ALCÜL four-conductor, two-hole mount and type ASR – ALCÜL™ and Type BX – ALCÜL



Type ASL – ALCÜL four-conductor, two-hole mount



Diagrams	Cat. no.	Conductor range (AWG or kcmil, Al or Cu)		Dimensions (in.)					
		Max.	Min.	L	W	H	D	F	I
	ASL60-42	600	2 Str.	4 ²⁹ / ₃₂	2 1/2	3	3/4	3/8	1 7/32
	ASL75-42	750	3/0 Str.	4 ²⁹ / ₃₂	2 ²⁷ / ₂₁	3	3/4	3/8	1 5/16



Type ASR – ALCÜL splicer reducer with solid barrier wire stop



Diagrams	ABB cat. no.	Conductor range (AWG or kcmil, Al or Cu)		Dimensions (In.)				
		Max.	Min.	L	W	H	I	Screws
	ASR0214*	#2	#14	0.95	0.45	0.56	0.53	2
	ASR1114*	1/0	#14	1.31	0.54	0.60	0.68	2
	ASR2506	250	#6	2.18	0.81	1.00	1.12	2
	ASR3506	350	#6	2.56	1.12	1.29	1.48	2
	ASR7525**	750	250	6.00	1.53	1.95	1.93	4

* Slotted screws. ** Two set screws per end. Not CSA certified. UL® 486B AL9CU



Type BX – ALCÜL rectangular connectors

- Features anti-rotational boss
- UL486B Recognized (90 °C rating)



Diagram	Cat. no.	Conductor range (AWG or kcmil, Al or Cu)		Style & size of boss (in.)	Boss hole tapped	Dimensions (in.)		
		Max.	Min.			L	W	H
	BX0214	2	14 Cu 12 Al	Square 0.229 in.	10-32	15/32	15/32	9/16
	BX1114	1/0	14 Cu 12 Al	Square 0.229 in.	10-32	5/8	17/32	39/64

Dual-rated mechanical connectors

Type GP, Type GT, Type TC and Tightening torque values for aluminum dual-rated socket screw connectors



Type GP – Aluminum dual-rated mechanical parallel tap connectors

Diagram	Cat. no.	Conductor range (AWG or kcmil, Al or Cu)		Dimensions (in.)		
		Main	Tap	W	L	H
	GP-2*	2–12 Str.	4–14	5/8	1 3/8	7/8
	GP-0	1/0–2	1/0–14	3/4	1 3/4	1
	GP-250-0	250–1/0	1/0–14	1 1/16	2 13/32	1 5/16
	GP-250	250–1/0	250–6	1 1/16	2 9/32	1 5/16
	GP-350	350–4/0	350–6	1 1/4	2 9/16	1 7/16
	GP-500	500–350	500–2	1 3/8	3 1/8	1 3/4
	GP-750	750–500	500–2	1 1/2	3 3/8	2

* Slotted screw, tap side. To include insulating cover, add suffix WC.



Type GT – Aluminum dual-rated mechanical parallel tap connectors



Diagram	Cat. no.	Conductor range (AWG or kcmil, Al or Cu)		Dimensions (in.)		
		Main	Tap	W	L	H
	GT-2*	2–12 Str.	4–14	5/8	1 3/8	7/8
	GT-0	1/0–2	1/0–14	3/4	1 3/4	1
	GT-250-0	250–1/0	1/0–14	1 1/16	2 9/32	1 5/16
	GT-250	250–1/0	250–6	1 1/16	2 9/32	1 5/16
	GT-350	350–4/0	350–6	1 1/4	2 9/16	1 7/16
	GT-500	500–350	500–2	1 3/8	3 1/8	1 3/4
	GT-750	750–500	500–2	1 1/2	3 3/8	2

* Slotted screw, tap side. To include insulating cover, add suffix WC.

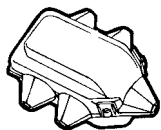

Type TC – Insulating covers for GP-GT



Diagram	Cat. no.	Dimensions (in.)			Use with connector
		L	W	H	
	TC-2	2 1/8	1 3/4	1 1/16	GP-2, GT-2
	TC-10	2 1/2	2 13/32	1 1/4	GP-0, GT-0
	TC250350	3 1/8	2 17/32	1 19/32	GP-250, GT-250, GP-350, GP-250-0, GT-250-0, GT-350
	TC-500	4 1/4	3 1/8	2 1/16	GP-500, GT-500
	TC-750	4 5/8	3 7/8	2 1/2	GP-750, GT-750

Color of all covers is black.

Tightening torque values for aluminum dual-rated socket screw connectors



AWG or circular mil size	Tightening torque in in.-lb.		AWG or circular mil size	Tightening torque in in.-lb.	
	Screw driver	Wrench		Screw driver	Wrench
12	20	75	4/0	–	200
10	20	75	250	–	250
8	20	75	350	–	250
6	35	100	500	–	300
4	35	100	600	–	300
2	50	125	700	–	300
1	50	125	750	–	300
1/0	50	150	800	–	400
2/0	50	150	1,000	–	400
3/0	–	200	–	–	–

Copper mechanical connectors

Type L, Type TL and Type S



- Cat. nos. L400 and L650 cast from high-strength bronze alloy

- Cat. nos. L35, L70, L125 and L250 cold forged from pure electrolytic copper with 99% conductivity

Type L – Single-conductor, one-hole mount



Diagrams	Cat. no.		Conductor range (AWG or kcmil)				Dimensions (in.)					
	Socket	Hex	Max.	Min.	L	W	H	F	D	J	E	G
	L35*	–	8 Str.	14 Sol.	1 ³ / ₁₆	3/ ₈	3/ ₈	3/ ₃₂	1 ³ / ₆₄	1 ¹ / ₆₄	1 ³ / ₆₄	1/ ₂
	L70*	–	4 Str.	14 Sol.	1 ¹ / ₈	1 ⁷ / ₃₂	3 ⁵ / ₆₄	3/ ₃₂	9/ ₃₂	9/ ₃₂	9/ ₃₂	2 ¹ / ₃₂
	L125BB	L125H	1/0 Str.	8 Sol.	1 ¹ / ₂	4 ⁷ / ₆₄	3/ ₄	3/ ₃₂	3/ ₈	2 ⁷ / ₆₄	2 ¹ / ₆₄	2 ⁷ / ₃₂
	L250	L250H	250	6 Str.	1 ⁶ / ₁₆	1 ⁵ / ₁₆	1 ¹ / ₁₆	1/ ₈	2 ⁹ / ₆₄	5/ ₈	1 ³ / ₃₂	1 ³ / ₃₂
	L400BB	L400H	500	4/0 Str.	3	1 ¹³ / ₃₂	1 ¹⁵ / ₃₂	9/ ₃₂	5/ ₈	7/ ₈	9/ ₁₆	1 ⁷ / ₈
	L650	L650H	1,000	500	4	2	2 ³ / ₁₆	1 ⁷ / ₃₂	3/ ₄	1 ¹ / ₄	9/ ₁₆	2

* Sizes L35 and L70 have screwdriver slot head screws only. UL[®] 486A.



- For use where large contact area is required to provide more secure mounting

- Cast from high-strength bronze alloy

Type L – Single-conductor, two-hole mount



Diagrams	Cat. no.		Conductor range (AWG or kcmil)				Dimensions (in.)						
	Socket	Hex	Max.	Min.	L	W	H	F	D	K	E	G	J
	L1252	L1252H	1/0 Str.	4 Str.	2 ¹³ / ₁₆	2 ⁵ / ₃₂	1 ³ / ₁₆	3/ ₁₆	7/ ₁₆	1	1 ¹ / ₃₂	2	2 ⁷ / ₆₄
	L2502	L2502H	250	1/0 Str.	3	1 ¹ / ₁₆	1 ¹ / ₃₂	1 ⁵ / ₆₄	7/ ₁₆	1	1 ³ / ₃₂	1 ⁷ / ₈	5/ ₈
	L4002	L4002H	500	4/0 Str.	3 ³ / ₈	1 ¹³ / ₃₂	1 ¹⁵ / ₃₂	5/ ₁₆	7/ ₁₆	1	1 ³ / ₃₂	1 ¹⁵ / ₁₆	5 ⁷ / ₆₄
	L6502	L6502H	1000	500	4 ¹⁵ / ₁₆	2	2	3/ ₈	9/ ₁₆	1 ¹ / ₂	9/ ₁₆	2 ³ / ₄	1 ¹ / ₄

UL 486A



- Conveniently terminates parallel conductors

Type TL – Two-conductor, two-hole mount



Diagrams	Cat. no.		Conductor range (AWG or kcmil)				Dimensions (in.)						
	Socket	Hex	Max.	Min.	L	W	H	F	D	K	E	G	J
	TL250	TL250H	250	1/0 Str.	4 ⁵ / ₁₆	1 ⁷ / ₈	1 ¹ / ₁₆	9/ ₃₂	1 ³ / ₄	5/ ₈	9/ ₁₆	3 ³ / ₁₆	5/ ₈
	TL400	TL400H	500	4/0 Str.	4 ³ / ₄	2 ⁹ / ₁₆	1 ⁹ / ₁₆	1 ³ / ₃₂	1 ³ / ₄	1 ¹ / ₁₆	9/ ₁₆	3	7/ ₈
	TL650	TL650H	1,000	500	5 ⁹ / ₁₆	3 ³ / ₄	2 ³ / ₁₆	9/ ₁₆	1 ³ / ₄	5/ ₈	9/ ₁₆	3 ³ / ₈	1 ¹ / ₄

Four hole NEMA tang on TL650. UL 486A.



- Cast of high-strength copper alloy
- Plated steel socket head set screws

Type S – Copper end-to-end splice connector



Diagrams	Cat. no.		Conductor range (AWG or kcmil)				Dimensions (in.)		
	Socket	Hex	Max.	Min.	L	W	H	J	I
	S100BB	–	1 Str.	4 Sol.	1 ¹¹ / ₁₆	5/ ₈	1 ¹ / ₁₆	3/ ₈	1 ⁵ / ₁₆
	S225BB*	–	4/0 Str.	1 Str.	2 ³ / ₁₆	2 ⁷ / ₃₂	3 ¹ / ₃₂	9/ ₁₆	1 ³ / ₁₆
	S400BB	–	500	4/0 Str.	2 ⁷ / ₈	1 ³ / ₁₆	1 ⁵ / ₁₆	7/ ₈	1 ⁷ / ₈

* Not UL listed.

Copper mechanical connectors

Direct-burial splice kits, Type STC and Type BTC



Direct-burial splice kits



Cat. no.	Description	Wire range (AWG)	Std. pkg. qty.
UFSK148DB	UF direct-burial splice kit	#14-#8	10
DBSK82	Direct-burial splice kit (non-UF)	#8-#2	10

- Fast, easy installation.
- Includes outer heat-shrink tubing insulator with adhesive sealant for rugged, watertight protection
- For underground feeder (UF) cable, UFSK148DB's four-in-one connector supports four-conductor, three-phase-plus-neutral or single-phase wiring systems
- For non-UF cable, DBSK82 offers easy-to-install, one-piece, aluminum alloy connector



- Uniquely designed pressure bar and notched V-bottom collar provide vise-like grip between conductor and terminal

- Made of electrolytic seamless copper with zinc-plated steel screws
- UL486A tested for copper conductor

Type STC – Copper single-conductor, one-hole mount lug with straight tang



Diagrams	Cat. no.	Fig. no.	Conductor range (AWG or kcmil, Cu)		Dimensions (in.)					
			Max.	Min.	L	W	H	F	E	D
	STC1014*	1	#10	#14	1	5/16	1/2	5/64	5/32	3/16
	STC0614	2	#6 Str.	#14	1 3/64	3/8	1 1/16	5/64	1 3/64	7/32
	STC0414	2	#4 Str.	#14	1 1/4	1/2	2 7/32	3/32	1 7/64	1/4
	STC0208	3	#2 Str.	#8 Str.	1 15/32	1/2	3 1/32	3/32	1 7/64	1/4
	STC1102	3	1/0 Str.	#2 Str.	1 15/16	5/8	1 1/4	1/8	1 7/64	7/16
	STC3104	3	3/0 Str.	#4 Str.	2 1/4	3/4	1 9/16	1/8	1 13/32	7/16
	STC4102	3	4/0 Str.	#2 Str.	2 3/8	1	1 2 1/32	1/8	1 11/32	1/2
	STC3511	3	350	1/0 Str.	3 3/4	1	1 5/8	3/16	1 13/32	5/8
	STC5011	3	500	1/0 Str.	3 7/8	1 1/2	1 13/16	3/16	1 13/32	1 5/16
	STC9960	3	1000	600	5	2	2 5/8	1/4	1 7/32	1 1/8

* Not CSA certified.



Mechanical lug for use with copper conductors.

Type BTC – Copper single-conductor one-hole mount lug with offset tang



Diagrams	Cat. no.	Fig. no.	Conductor range (AWG or kcmil, Cu)		Dimensions (in.)					
			Max.	Min.	L	W	H	F	E	D
	BTC1014*	1	#10	#14	1	5/16	43/64	5/64	5/32	3/16
	BTC0614	2	#6 Str.	#14	1 3/32	3/8	2 5/32	5/64	1 3/64	7/32
	BTC0208	2	#2 Str.	#8 Str.	1 15/32	1/2	2 7/32	3/32	1 7/64	1/4
	BTC1102	2	1/0 Str.	#2 Str.	1 25/32	5/8	1 13/32	1/8	1 7/64	7/16
	BTC3104	2	3/0 Str.	#4 Str.	2 3/64	3/4	1 9/16	1/8	1 13/32	7/16
	BTC4102	2	4/0 Str.	#2 Str.	2 9/16	1	1 6 1/64	1/8	1 11/32	1/2
	BTC3511	2	350	1/0 Str.	3 3/4	1	2 1/2	3/16	1 13/32	5/8
	BTC5011	2	500	1/0 Str.	4 1/4	1 1/2	2 2 1/32	3/16	1 13/32	1 5/16
	BTC9960	2	1000	600	4 3/4	2	3 9/16	1/4	1 7/32	1 1/8

* Not CSA certified.

Copper mechanical connectors

LOCKTITE® one-hole lugs and one-hole flag-type lugs



Only nine lug sizes fit cables from #14 to 1000 kcmil.

- Easily installed with key wrench
- Saddle and cable socket make direct, all-around, low-resistance contact with cable
- Convenient peephole permits easy inspection
- For use with code copper conductor (600 V)

LOCKTITE one-hole lugs



Diagrams	Cat. no.	Cable size (AWG or kcmil)	Dimensions (in.)						
			G	A	B	C	D	J	F
	31003 [†]	14–8	1/4	1 1/8	9/16	1/2	1/8	17/32	9/32
	31005-TB [†]	8–4	1/4	1 1/8	5/8	1/2	1/8	17/32	9/32
	31007	4–1	1/4	1 5/8	13/16	5/8	7/32	1	11/32
	31009	1–2/0	3/8	1 15/16	1	13/16	1/4	1 3/16	7/16
	31011	2/0–4/0	3/8	2 3/8	1 1/4	1	9/32	1 13/32	17/32
	31013	4/0–300	1/2	2 3/4	1 1/2	1 3/16	5/16	1 17/32	5/8
	31015	300–500	1/2	3 1/16	1 11/16	1 3/8	11/32	1 13/16	3/4
	31017	500–750	1/2	3 25/32	2 3/16	1 5/8	13/32	2 1/8	1
	31019	750–1000	5/8	4 5/16	2 15/32	1 7/8	15/32	2 11/32	1 3/16

[†]With filister head screw. All others, hex socket screws.



- For use with code copper conductor (600 V)

LOCKTITE one-hole flag-type lugs



Diagrams	Cat. no.	Cable size (AWG)	Dimensions (in.)							
			G	A	B	C	D	J	F	E
	31005-AL [†]	8–4	1/4	1 1/8	5/8	1/2	1/8	17/32	9/32	1/2

[†]With filister head screw.

Bolt holes and spacings listed are standard, but lugs with blank tongues can be furnished.
For torque requirements, see page 41.

Copper mechanical connectors

LOCKTITE® one-hole 90° upright lugs, two-hole lugs and two-hole NEMA-drilled lugs



- For use with code copper conductor (600 V)
- All the outstanding LOCKTITE lug features – Plus two-bolt capacity

LOCKTITE one-hole 90° upright lugs



Cat. no.	Cable size (AWG)	Dimensions (in.)						
		G	A	B	C	D	J	F
31005-UAL†	8–4	1/4	1 1/8	5/8	1/2	1/8	1/2	9/32
31007-UAL	4–1	1/4	1 21/32	13/16	5/8	7/32	13/16	11/32
31009-UAL	1–2/0	3/8	2 1/32	1	13/16	1/4	15/16	7/16
31011-UAL	2/0–4/0	3/8	2 1/2	1 1/4	1	9/32	1 1/8	17/32

†With filister head screw. All others, hex head screws.
Bolt holes and spacings listed are standard, but lugs with blank tongues can be furnished.



- Easy installation
- High conductivity
- Wide cable range
- Long tongue adapted for two bolts
- For use with code copper conductor (600 V)

LOCKTITE two-hole lugs



Cat. no.	Cable size (AWG or kcmil)	Dimensions (in.)								
		G	A	B	C	D	J	F	H	
32003†	14–8	1/4	1 11/16	1 1/4	1/2	1/8	15/32	9/32	5/8	
32005†	8–4	1/4	1 3/4	1 1/4	1/2	1/8	17/32	9/32	5/8	
32007	4–1	1/4	2 1/4	1 7/16	5/8	7/32	7/8	9/32	3/4	
32009	1–2/0	3/8	2 7/8	1 15/16	13/16	1/4	13/32	7/16	1	
32011	2/0–4/0	3/8	3 3/8	2	1	9/32	15/16	7/16	1	
32013	4/0–300	3/8	3 3/8	2 1/8	1 3/16	5/16	1 9/16	7/16	1	
32015	300–500	3/8	3 1/2	2 1/8	1 3/8	11/32	2 17/32	7/16	1	
32017	500–750	1/2	4 19/32	3	1 3/4	13/32	2 1/8	9/16	1 1/2	
32019	750–1,000	1/2	4 27/32	3	1 7/8	15/32	2 11/32	9/16	1 1/2	

†With filister head screw. All others, hex head screws.
For torque requirements, see page 41.



- Furnished with bolt holes and spacings to fit equipment with NEMA-type connector mounting pads

LOCKTITE two-hole NEMA-drilled lugs



Cat. no.	Cable size (AWG or kcmil)	Dimensions (in.)								
		G	A	B	C	D	J	F	H	
32207	4–1	3/8	2 13/16	2	3/4	7/32	7/8	7/16	1	
32209	1–2/0	1/2	3 15/16	3	1	1/4	1 1/16	9/16	1 3/4	
32211	2/0–4/0	1/2	4 7/8	3	1	9/32	1 9/32	9/16	1 3/4	
32213	4/0–300	1/2	4 3/16	3	1 3/16	5/16	1 15/32	9/16	1 3/4	
32215	300–500	1/2	4 7/8	3 1/2	1 3/8	11/32	1 13/16	9/16	1 3/4	
32217	500–750	1/2	5 3/32	3 1/2	1 3/4	13/32	2 1/8	9/16	1 3/4	
32219	750–1,000	1/2	5 1/4	3 1/2	3	15/32	2 1/8	9/16	1 3/4	

For torque requirements, see page 41.

Copper mechanical connectors

LOCKTITE® double- and triple-barrel NEMA-drilled lugs for 600 V applications

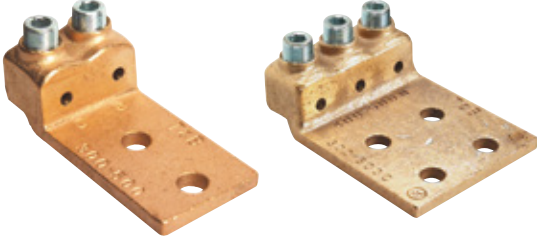

All the same features as the standard LOCKTITE lug – With two or three barrels.

- Screw tightening
- Serrated saddle
- Built-in lockwasher
- For use with code copper conductor (600 V)

LOCKTITE double- and triple-barrel NEMA-drilled lugs for 600 V applications



Cat. no.	Cable size (AWG or kcmil)	Fig.	Bolt size (in.)	Dimensions (in.)								
				A	B	C	D	E	F	H	J	
32003BD†	14–8	A	1/4	2 ³ / ₁₆	1 ³ / ₄	5/8	1/8	1 ¹ / ₁₆	9/32	5/8	1 ⁵ / ₃₂	
32005BD†	8–4	A	1/4	2 ¹ / ₂	2	1	1/8	1	9/32	5/8	1 ⁷ / ₃₂	
32007BD	4–1	A	3/8	2 ¹³ / ₁₆	2	1 ¹ / ₄	7/32	1 ¹ / ₄	7/16	1	2 ⁹ / ₃₂	
32009BD	1–2/0	A	1/2	4 ⁷ / ₁₆	3 ¹ / ₂	1 ¹ / ₂	1/4	1 ⁹ / ₁₆	5/8	1 ³ / ₄	1 ¹³ / ₃₂	
32011BD	2/0–4/0	A	1/2	4 ⁵ / ₈	3 ¹ / ₂	1 ³ / ₄	9/32	1 ³ / ₄	5/8	1 ³ / ₄	1 ⁵ / ₁₆	
32013BD	4/0–300	A	1/2	4 ³ / ₄	3 ¹ / ₂	2	5/16	2 ¹ / ₈	5/8	1 ³ / ₄	1 ⁹ / ₁₆	
32015BD	300–500	A	1/2	5 ³ / ₈	3 ¹⁵ / ₁₆	2 ¹ / ₂	1 ¹ / ₃₂	2 ¹ / ₂	5/8	1 ³ / ₄	1 ¹³ / ₁₆	
32017BD	500–700	B	1/2	5 ¹⁹ / ₃₂	4	4	1 ¹³ / ₃₂	2 ¹⁵ / ₁₆	5/8	1 ³ / ₄	2 ¹ / ₈	
32019BD	750–1000	B	1/2	5 ²⁷ / ₃₂	4	4	1 ¹⁵ / ₃₂	3 ¹ / ₄	5/8	1 ³ / ₄	2 ¹¹ / ₃₂	
32011TB	2/0–4/0	C	1/2	4 ⁵ / ₈	3 ³ / ₈	2 ¹ / ₂	9/32	2 ³ / ₄	5/8	1 ³ / ₄	1 ⁵ / ₁₆	
32013TB	4/0–300	C	1/2	4 ³ / ₄	3 ¹ / ₂	3	5/16	3 ¹ / ₄	5/8	1 ³ / ₄	1 ¹⁷ / ₃₂	
32015TB	300–500	D	1/2	5 ³ / ₈	4	4	1 ¹¹ / ₃₂	3 ³ / ₄	5/8	1 ³ / ₄	1 ¹³ / ₁₆	
32017TB	500–750	D	1/2	5 ¹⁹ / ₃₂	4	4	1 ¹³ / ₃₂	4 ³ / ₈	5/8	1 ³ / ₄	2 ¹ / ₈	
32019TB	750–1,000	D	1/2	5 ²⁷ / ₃₂	4	4	1 ¹⁵ / ₃₂	4 ¹³ / ₁₆	5/8	1 ³ / ₄	2 ¹¹ / ₃₂	

Diagrams

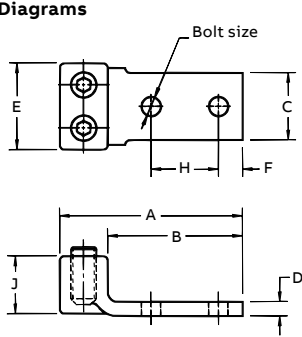

Fig. A

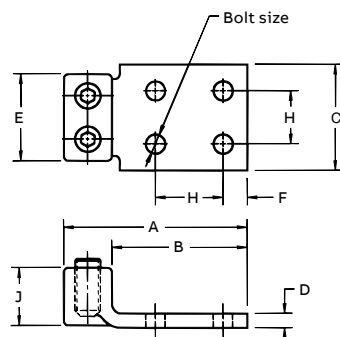

Fig. B

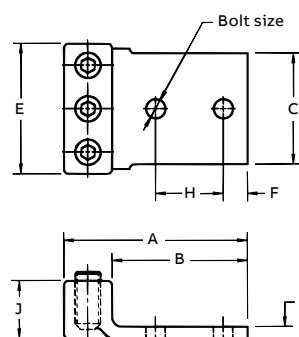

Fig. C

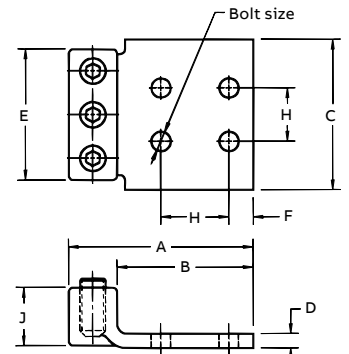

Fig. D

†With filister head screw.

For torque requirements, see page 41.

Copper mechanical connectors

LOCKTITE® two-way connectors and tee-parallel taps



Join two cables end-to-end.

- Cables held by saddle and tightened by screws
- Built-in lockwashers
- For use with code copper conductor (600 V)



LOCKTITE two-way connectors

Diagrams	Cat. no.	Cable size (AWG or kcmil)	Dimensions (in.)		
			A	E	J
	32503†	14 Sol.–8 Sol.	1 ¹ / ₈	³ / ₈	1 ⁵ / ₃₂
	32505†	8 Sol.–4 Str.	1 ³ / ₈	¹ / ₂	1 ⁷ / ₃₂
	32507	4 Sol.–1 Str.	1 ⁵ / ₈	⁵ / ₈	2 ⁷ / ₃₂
	32509	1 Sol.–2/0	1 ⁷ / ₈	³ / ₄	1 ¹ / ₃₂
	32511	2/0–4/0	2 ⁵ / ₁₆	1 ⁵ / ₁₆	1 ¹ / ₄
	32513	4/0–300	2 ⁹ / ₁₆	1 ¹ / ₈	1 ¹ / ₂
	32515	300–500	2 ³ / ₄	1 ¹ / ₄	1 ²⁵ / ₃₂
	32517	500–750	3 ¹ / ₈	1 ¹ / ₂	2 ¹ / ₁₆
	32519	750–1,000	3 ⁷ / ₈	1 ¹¹ / ₁₆	2 ⁹ / ₃₂

†With filister head screw. For torque requirements, see page 41.



Designed for easy, one-person installation.

- Tap hangs on main while branch is inserted
- Simply tighten screw to lock in place
- For use with code copper conductor (600 V)



LOCKTITE tee-parallel taps

Diagrams	Cat. no.	Cable size (AWG or kcmil)		Dimensions (in.)		
		Main	Branch	A	B	C
	35011	300–500	2–3/0	2 ¹ / ₂	1 ³ / ₄	1 ¹ / ₄
	35013	300–500	4/0–500	3 ¹ / ₁₆	1 ⁷ / ₈	1 ⁵ / ₈
	35015	500–750	2–3/0	2 ¹³ / ₁₆	1 ¹⁵ / ₁₆	1 ¹ / ₄
	35017	500–750	4/0–500	3 ³ / ₈	2 ¹ / ₁₆	1 ⁵ / ₈
	35019	500–750	500–750	4	2 ¹ / ₁₆	2 ¹ / ₁₆

For torque requirements, see page 41.

Copper mechanical connectors

LOCKTITE® tandem-type two-hole NEMA-drilled lugs, ground bus taps and pigtail connectors



For stranded, solid, flexible and other types of cables.

- Each lug takes a range of wire sizes

- Bolt holes and spacings listed are standard
- For use with code copper conductor (600 V)

LOCKTITE tandem-type two-hole NEMA-drilled lugs



Diagrams	Cat. no.	Cable size (AWG or kcmil)	Dimensions (in.)							
			G	A	B	C	D	J	F	H
	32007TL	4-1	$\frac{3}{8}$	$3\frac{9}{16}$	2	$\frac{3}{4}$	$\frac{7}{32}$	$\frac{29}{32}$	$\frac{7}{16}$	1
	32009TL	1-2/0	$\frac{1}{2}$	$4\frac{15}{16}$	3	1	$\frac{1}{4}$	$1\frac{3}{32}$	$\frac{9}{16}$	$1\frac{3}{4}$
	32011TL	2/0-4/0	$\frac{1}{2}$	$5\frac{3}{8}$	3	1	$\frac{9}{32}$	$1\frac{5}{16}$	$\frac{9}{16}$	$1\frac{3}{4}$
	32013TL	4/0-300	$\frac{1}{2}$	$5\frac{5}{8}$	3	$1\frac{3}{16}$	$\frac{5}{16}$	$1\frac{9}{16}$	$\frac{9}{16}$	$1\frac{3}{4}$
	32015TL	300-500	$\frac{1}{2}$	$6\frac{11}{32}$	$3\frac{1}{2}$	$1\frac{3}{8}$	$\frac{11}{32}$	-	$\frac{5}{8}$	$1\frac{3}{4}$
	32017TL	500-750	$\frac{1}{2}$	$6\frac{23}{32}$	$3\frac{1}{2}$	$1\frac{3}{4}$	$\frac{13}{32}$	$2\frac{1}{8}$	$\frac{5}{8}$	$1\frac{3}{4}$



For easy installation in hard-to-reach places.

- Eliminate the need to drill holes in the ground bus
- Can be placed quickly at any location
- Install with only a key wrench

- Standard LOCKTITE lug grip securely holds tapping cable
- For use with code copper conductor (600 V)

LOCKTITE ground bus taps for $\frac{1}{4}$ " copper bus bar



Diagrams	Cat. no.	Wire size (AWG or kcmil)	Dimensions (in.)		
			A	B	Bus thickness (in.)
	31207	8-4	$2\frac{3}{4}$	$1\frac{3}{4}$	$\frac{1}{4}$
	31208	4-1	$2\frac{9}{16}$	$1\frac{3}{4}$	$\frac{1}{4}$
	31209	1-2/0	$2\frac{3}{4}$	$1\frac{3}{4}$	$\frac{1}{4}$
	31210	2/0-4/0	$2\frac{3}{4}$	$1\frac{3}{4}$	$\frac{1}{4}$
	31211	4/0-300	$2\frac{7}{8}$	$1\frac{3}{4}$	$\frac{1}{4}$
	31212	300-500	3	$1\frac{3}{4}$	$\frac{1}{4}$

For torque requirements, see page 41.



- For use with code copper conductor (600 V)

LOCKTITE pigtail connectors



Diagrams	Cat. no.	Wire size (AWG)	Cable fig.	Dimensions (in.)	
				A	J
	31305	10-8	A	$\frac{1}{2}$	$\frac{17}{32}$
	31307	8-6	A	$\frac{3}{4}$	$\frac{27}{32}$
	31309	6-4	B	$\frac{7}{8}$	$1\frac{1}{32}$
	31311	4-2	B	$1\frac{1}{16}$	$1\frac{1}{4}$
	31313	1-2/0	B	$1\frac{3}{16}$	$1\frac{1}{2}$
	31315	2/0-4/0	B	$1\frac{5}{16}$	$1\frac{25}{32}$

For torque requirements, see page 41.

Note:--order with hex head screws (available on all except 10-8 code size), add prefix H--catalog number.

Copper mechanical conductors

LOCKTITE® stud connectors and LUG-IT one-hole lugs



- Fast, simple installation
- Convenient pigtail is easy to tape
- To order with hex head screws, add prefix H to catalog number

- Standard tapping shown in diagrams
- Other tapping to meet specific requirements available on request
- For use with code copper conductor (600 V)

LOCKTITE stud connectors



		Male – Type MS							Female – Type FL						
		Cable size	Dimensions (in.)					Stud	Cable size		Dimensions (in.)				
Diagrams	Cat. no.	(AWG or kcmil)	A	B	D	E	F	size (in.)	Cat. no.	(AWG or kcmil)	Fig.	G	A	B	
	31007-T	4-1	1 3/8	2 5/32	7/8	5/8	3/4	3/8-16	31262†	8-4	A	3/8-16	1 1/16	5/8	
	31009-T	1-2/0	1 5/8	7/8	1	3/4	3/4	3/8-16	31263	4-1	B	3/8-16	1 15/32	3/4	
	31011-T	2/0-4/0	1 5/8	1 1/16	1 3/16	7/8	1	1/2-13	31265	4-1	B	1/2-13	1 15/32	3/4	
	31013-T	4/0-300	1 7/8	1 3/16	1 3/8	1 1/16	1	1/2-13	31267	2/0-4/0	B	1/2-13	2 3/16	1 3/16	
	31015-T	300-500	2 5/32	1 5/16	1 1/2	1 1/4	1	1/2-13							

†With filister head screw.



- Designed to grip cable firmly between its strong body and serrated copper tongue.**
- Double laps at top give greater thread strength and lock screw when tightened

- Copper tongue makes a low-resistance terminal
- For use with code copper conductor (600 V)

LOCKTITE LUG-IT one-hole lugs, offset tongue



		Cable size	Dimensions (in.)					
		(AWG)	G	A	B	C	D	F
	35301	14-6	#10	1 3/16	1/2	3/8	0.064	7/32
	35401	8-2	1/4	1 7/16	5/8	1/2	0.081	1/4
	35501*†	4-2/0	1/4	1 13/16	13/16	3/4	0.101	3/8
	35601*†	1/0-4/0	3/8	2 17/32	1 3/32	1	0.128	1/2

* Aluminum body. †Hex head bolt. Add suffix G to above cat. nos. for lug connector with green screw for grounding identification. For torque requirements, see table at left.

ABB recommended tightening torque for copper connections

Size of conductor ranges (AWG)	Wrench torque (in.-lbs.)	Screw driver torque (in.-lbs.)
14-8	-	20
8-4	-	35
4-1	125	-
1-2/0	150	-
2/0-4/0	200	-

ABB recommended tightening torque for copper connections

Size of conductor ranges (AWG or kcmil)	Wrench torque (in.-lbs.)	Screw driver torque (in.-lbs.)
4/0-300	250	-
300-500	300	-
500-750	300	-
750-1,000	400	-

Copper mechanical conductors

LOCKTITE® cone screw lugs and HINJON junior tee-parallel taps



High pull-out strength and low resistance.

- Conically shaped screw compresses copper conductor so each strand is forced to carry its share of the load

- Exerts equal pressure on each conductor strand
- For use with code copper conductor (600 V)

LOCKTITE cone screw lugs



Diagrams	Cat. no.	Wire range (AWG or kcmil)	Dimensions (in.)							Torque (in.-lbs.)
			G	A	B	C	D	E	F	
	71003	14-8	#10	13/16	7/16	3/8	3/32	3/8	3/16	20*
	71005	14-4	1/4	1 5/32	5/8	9/16	1/8	19/32	9/32	35*
	71010	4-2/0	3/8	1 21/32	27/32	23/32	3/16	25/32	3/8	150
	71014	2-4/0	3/8	1 7/8	29/32	15/16	3/16	31/32	3/8	200
	71015	1-250	3/8	2 1/32	29/32	1	7/32	1	3/8	250
	71020	2/0-500	1/2	2 3/4	1 1/4	1 11/32	9/32	1 15/32	9/16	300

Add suffix G to lug Cat. No. 71003, 71005, 71010 and 71014 for lug with green screw for grounding identification. UL File No. E-9609. *Indicates screwdriver torque; all others indicate torque wrench.

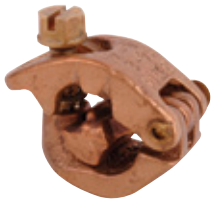

The most economical, easiest to install, approved connector for large to small branch taps.

- All-around-grip jaws
- Automatically adjusts to size of main and branch

- Fast, simple installation with just a screwdriver or pliers
- Fitting can be easily taped

HINJON junior tee-parallel taps



Diagrams	Cat. no.	Cable size (AWG or kcmil)		Dimensions (in.)		
		Main	Branch	A	B	C
	35107	8-4	14-8	1 1/16	7/8	5/8
	35109	4-1/0	14-4	1 1/4	1	1 1/16
	35111	1/0-4/0	14-4	1 3/4	1 3/8	27/32
	35112	1/0-4/0	8-1	1 5/8	1 9/16	27/32
	35115	300-500	14-4	1 7/8	1 13/16	1

ABB recommended tightening torque

Size of conductor ranges (AWG or kcmil)	Wrench torque (in.-lbs.)	Screw driver torque (in.-lbs.)
14-8	20	20
14-4	35	35
4-2/0	150	-
2-4/0	200	-
1-250	250	-
2/0-500	300	-

Clamp connectors

XT™ clamp for tee tap, cross, parallel and end-to-end connectors and DLC™ single U-bolt aluminum fittings



Connectors for a variety of applications.

- Copper alloy castings provide high strength for heavy-duty applications
- Silicon-bronze bolts built to handle frequent moves, adds and changes

XT clamp for tee tap, cross, parallel and end-to-end connectors

Diagrams	Cat. no.	Conductor range (AWG or kcmil)				Conductor diameter (in.)				Dimensions (in.)			Bolt size
		Main		Tap		A		B		L	H	W	
		Max.	Min.	Max.	Min.	Max.	Min.	Max.	Min.				
	XT12	4/0 Str.	#1 Str.	#2 Str.	#6 Sol.	0.528	0.328	0.292	0.162	1½	1³⁄₁₆	1½	⁵⁄₁₆
	XT13			4/0 Str.	#1 Str.	0.528	0.328	0.528	0.328	1⁷⁄₈	2	1⁷⁄₈	³⁄₈
	XT21	500	250	#2 Str.	#6 Sol.	0.813	0.574	0.292	0.162	2¹⁄₁₆	2³⁄₁₆	1⁵⁄₈	³⁄₈
	XT22			4/0 Str.	#1 Str.	0.813	0.574	0.528	0.328	2¹⁄₈	2³⁄₁₆	2⁷⁄₈	³⁄₈
	XT23*			500	250	0.813	0.574	0.813	0.574	2¹⁄₈	2³⁄₁₆	2¹⁄₂₆	³⁄₈
	XT33*	1000	500	500	250	1.152	0.811	0.813	0.574	2¼	3	2¹⁵⁄₁₆	³⁄₈
	XT34*			1000	500	1.152	.811	1.152	0.811	2¹¹⁄₁₆	3½	2¹¹⁄₁₆	⁷⁄₁₆

* 4-bolt clamps

Note: For tin-plating option, add "-P" suffix to the catalog number.



DLC2106

Deadend loop connections.

- Top and bottom pressure pads cast of high-strength, heat-treated, aluminum-silicon alloy
- Hardware made of galvanized steel provides added strength and durability

DLC single U-bolt aluminum fittings

Diagrams	Cat. no.	Conductor range (AWG or kcmil)				Conductor diameter (in.)				Dimensions (in.)				
		ACSR		AWG or kcmil		A		B		W	L	H	F	E
		Main	Tap	Main	Tap	Max.	Min.	Max.	Min.					
	DLC2106*	2/0-#6	2/0-#6	2/0 Str.-#6 Sol.	2/0 Str.-#6 Sol.	0.447	0.162	0.447	0.162	1⁷⁄₈	1½	3¼	⁹⁄₁₆	³⁄₈
	DLC23*	4/0-#1, #2-#6 AR	4/0-1/0	266.8-1/0 Str.	266.8-1/0 Str.	0.563	0.368	0.609	0.368	2³⁄₈	2⁷⁄₈	4	¾	½
	DLC25	336.4-1/0, 1/0-#6 AR	336.4-1/0, 1/0-#6 AR	397.5-1/0 Str.	397.5-1/0 Str.	0.684	0.368	0.743	0.368	2³⁄₈	3³⁄₁₆	4	¾	½

* RUS accepted, AR - With Armor Rod.

Note: For oxide-inhibitor option with aluminum-to-copper applications, add "-9" suffix to the catalog number.

Appendix

Part number index

Cat. no.	Page	Cat. no.	Page	Cat. no.	Page	Cat. no.	Page
1000HPS	6	31003	36	32013TB	38	40HPW	7
1000M	5	31005-AL	36	32013TL	40	4AAW	8
10AAW	8	31005-TB	36	32015	37	4CA	8
10CA	8	31005-UAL	37	32015BD	38	4H	5
10H	5	31007	36	32015TB	38	4H3	5
10HPS	6	31007-T	41	32015TL	40	4HPS	6
10HPW	7	31007-UAL	37	32017	37	4HPW	7
1AAW	8	31009	36	32017BD	38	500HPS	6
1CA	8	31009-T	41	32017TB	38	500M	5
1H	5	31009-UAL	37	32017TL	40	6AAW	8
1H3	5	31011	36	32019	37	6CA	8
1HPS	6	31011-T	41	32019BD	38	6H	5
1HPW	7	31011-UAL	37	32019TB	38	6H3	5
20H	5	31013	36	32207	37	6HPS	6
20HPS	6	31013-T	41	32209	37	6HPW	7
20HPW	7	31015	36	32211	37	71003	42
2AAW	8	31015-T	41	32213	37	71005	42
2B10	13	31017	36	32215	37	71010	42
2B1000	13	31019	36	32217	37	71014	42
2B1000PW	14	31207	40	32219	37	71015	42
2B1000W	14	31208	40	32503	39	71020	42
2B1000X	13	31209	40	32505	39	750HPS	6
2B10PW	14	31210	40	32507	39	750M	5
2B10W	14	31211	40	32509	39	8H	5
2B10X	13	31212	40	32511	39	8H3	5
2B20BB	13	31262	41	32513	39	8HPS	6
2B20PW	14	31263	41	32515	39	9H	5
2B20W	14	31265	41	32517	39	9HPS	6
2B20X	13	31267	41	32519	39	ADR02-32	29
2B350	13	31305	40	35011	39	ADR02-34	30
2B350PW	14	31307	40	35013	39	ADR11	27
2B350W	14	31309	40	35015	39	ADR11-21	28
2B350X	13	31311	40	35017	39	ADR11-32	29
2B40	13	31313	40	35019	39	ADR11-34	30
2B40PW	14	31315	40	350HPS	6	ADR2	27
2B40W	14	32003	37	350M	5	ADR21	27
2B40X	13	32003BD	38	35107	42	ADR21-21	28
2B500	13	32005	37	35109	42	ADR21-AR	26
2B500PW	14	32005BD	38	35111	42	ADR25	27
2B500W	14	32007	37	35112	42	ADR25-12S	28
2B500X	13	32007BD	38	35115	42	ADR25-21	28
2B800	13	32007TL	40	35301	41	ADR25-32	29
2B800PW	14	32009	37	35401	41	ADR25-34	30
2B800W	14	32009BD	38	35501	41	ADR25-44	30
2B800X	13	32009TL	40	35601	41	ADR30	27
2CA	8	32011	37	3H	5	ADR30-AR	26
2H	5	32011BD	38	3H3	5	ADR31-32	29
2H3	5	32011TB	38	40AAW	8	ADR31-34	30
2HPS	6	32011TL	40	40CA	8	ADR35	27
2HPW	7	32013	37	40H	5	ADR35-12#	27
30H	5	32013BD	38	40HPS	6	ADR35-12S	28

Appendix

Part number index

Cat. no.	Page	Cat. no.	Page	Cat. no.	Page	Cat. no.	Page
ADR35-21	28	AMTD10146	20	AMTD4145	20	AMTDM3068	22
ADR35-21-AR	26	AMTD10147	20	AMTD4146	20	AMTDM3069	22
ADR35-22	29	AMTD10148	20	AMTD4147	20	AMTDM350610	22
ADR35-32	29	AMTD10149	20	AMTD4148	20	AMTDM350611	22
ADR35-34	30	AMTD250610	20	AMTD4149	20	AMTDM350612	22
ADR35-44	30	AMTD250611	21	AMTD500410	21	AMTDM35062	22
ADR35-AR	26	AMTD250612	21	AMTD500411	21	AMTDM35063	22
ADR50	27	AMTD250613	21	AMTD500412	21	AMTDM35064	22
ADR50-12S	28	AMTD250614	21	AMTD500413	21	AMTDM35065	22
ADR50-32	29	AMTD25062	20	AMTD500414	21	AMTDM35066	22
ADR50-34	30	AMTD25063	20	AMTD50042	21	AMTDM35067	22
ADR6	27	AMTD25064	20	AMTD50043	21	AMTDM35068	22
ADR60	27	AMTD25065	20	AMTD50044	21	AMTDM35069	22
ADR6004	27	AMTD25066	20	AMTD50045	21	AMTDM500410	22
ADR60-12D	27	AMTD25067	20	AMTD50046	21	AMTDM500411	22
ADR60-21	28	AMTD25068	20	AMTD50047	21	AMTDM500412	22
ADR60-21-AR	26	AMTD25069	20	AMTD50048	21	AMTDM50042	22
ADR60-22D	29	AMTD30610	20	AMTD50049	21	AMTDM50043	22
ADR60-32D	29	AMTD30611	20	AMTD75025010	21	AMTDM50044	22
ADR60-34D	30	AMTD30612	20	AMTD75025011	21	AMTDM50045	22
ADR60-44D	30	AMTD30613	20	AMTD75025012	21	AMTDM50046	22
ADR60-AR	26	AMTD30614	20	AMTD75025013	21	AMTDM50047	22
ADR80	27	AMTD3062	20	AMTD75025014	21	AMTDM50048	22
ADR80-12D	27	AMTD3063	20	AMTD7502502	21	AMTDM50049	22
ADR80-12DS	28	AMTD3064	20	AMTD7502503	21	AMTDM75025010	22
ADR80-21	28	AMTD3065	20	AMTD7502504	21	AMTDM75025011	22
ADR80-22D	29	AMTD3066	20	AMTD7502505	21	AMTDM75025012	22
ADR80-32	29	AMTD3067	20	AMTD7502506	21	AMTDM7502502	22
ADR80-34	30	AMTD3068	20	AMTD7502507	21	AMTDM7502503	22
ADR80-44D	30	AMTD3069	20	AMTD7502508	21	AMTDM7502504	22
ADR99	27	AMTD350610	21	AMTD7502509	21	AMTDM7502505	22
ADR99-12D	27	AMTD350611	21	AMTDM250610	22	AMTDM7502506	22
ADR99-12DS	28	AMTD350612	21	AMTDM250611	22	AMTDM7502507	22
ADR99-21	28	AMTD350613	21	AMTDM250612	22	AMTDM7502508	22
ADR99-22D	29	AMTD350614	21	AMTDM25062	22	AMTDM7502509	22
ADR99-32	29	AMTD35062	21	AMTDM25063	22	AMTS101410	18
ADR99-34	30	AMTD35063	21	AMTDM25064	22	AMTS101411	18
AMT20	18	AMTD35064	21	AMTDM25065	22	AMTS101412	18
AMT250	18	AMTD35065	21	AMTDM25066	22	AMTS101413	18
AMT350	19	AMTD35066	21	AMTDM25067	22	AMTS101414	18
AMT500	19	AMTD35067	21	AMTDM25068	22	AMTS10142	18
AMTC4	18	AMTD35068	21	AMTDM25069	22	AMTS10143	18
AMTD101410	20	AMTD35069	21	AMTDM30610	22	AMTS10144	18
AMTD101411	20	AMTD41410	20	AMTDM30611	22	AMTS10145	18
AMTD101412	20	AMTD41411	20	AMTDM30612	22	AMTS10146	18
AMTD101413	20	AMTD41412	20	AMTDM3062	21	AMTS10147	18
AMTD101414	20	AMTD41413	20	AMTDM3063	21	AMTS10148	18
AMTD10142	20	AMTD41414	20	AMTDM3064	21	AMTS10149	18
AMTD10143	20	AMTD4142	20	AMTDM3065	21	AMTS250610	19
AMTD10144	20	AMTD4143	20	AMTDM3066	21	AMTS250611	19
AMTD10145	20	AMTD4144	20	AMTDM3067	22	AMTS250612	19

Appendix

Part number index

Cat. no.	Page	Cat. no.	Page	Cat. no.	Page	Cat. no.	Page
AMTS250613	19	AMTS500412	19	ASR7525	32	CSB 350-7 S	15
AMTS250614	19	AMTS500413	19	BTC0208	35	CSB 350-8	16
AMTS25062	18	AMTS500414	19	BTC0614	35	CSB 350-8 S	15
AMTS25063	18	AMTS50042	19	BTC1014	35	CSB 4-2	16
AMTS25064	18	AMTS50043	19	BTC1102	35	CSB 4-2 S	15
AMTS25065	18	AMTS50044	19	BTC3104	35	CSB 4-3	16
AMTS25066	18	AMTS50045	19	BTC3511	35	CSB 4-3 S	15
AMTS25067	18	AMTS50046	19	BTC4102	35	CSB 4-4	16
AMTS25068	19	AMTS50047	19	BTC5011	35	CSB 4-4 SAH	15
AMTS25069	19	AMTS50048	19	BTC9960	35	CSB 4-5	16
AMTS30610	18	AMTS50049	19	BX0214	32	CSB 4-5 S	15
AMTS30611	18	AMTS75025010	19	BX1114	32	CSB 4-6	16
AMTS30612	18	AMTS75025011	19	CSB 2/0-2	16	CSB 4-6 S	15
AMTS30613	18	AMTS75025012	19	CSB 2/0-2 S	15	CSB 4-7	16
AMTS30614	18	AMTS75025013	19	CSB 2/0-3	16	CSB 4-7 S	15
AMTS3062	18	AMTS75025014	19	CSB 2/0-3 S	15	CSB 4-8	16
AMTS3063	18	AMTS7502502	19	CSB 2/0-4	16	CSB 4-8 SAH	15
AMTS3064	18	AMTS7502503	19	CSB 2/0-4 S	15	CSB 500-2	16
AMTS3065	18	AMTS7502504	19	CSB 2/0-5	16	CSB 500-2 S	15
AMTS3066	18	AMTS7502505	19	CSB 2/0-5 S	15	CSB 500-3	16
AMTS3067	18	AMTS7502506	19	CSB 2/0-6	16	CSB 500-3 S	15
AMTS3068	18	AMTS7502507	19	CSB 2/0-6 S	15	CSB 500-4	16
AMTS3069	18	AMTS7502508	19	CSB 2/0-7	16	CSB 500-4 S	15
AMTS350610	19	AMTS7502509	19	CSB 2/0-7 S	15	CSB 500-5	16
AMTS350611	19	AMTSR10	17	CSB 2/0-8	16	CSB 500-5 S	15
AMTS350612	19	AMTSR250	17	CSB 2/0-8 S	15	CSB 500-6	16
AMTS350613	19	AMTSR350	17	CSB 250-2	16	CSB 500-6 S	15
AMTS350614	19	AMTSR500	17	CSB 250-2 S	15	CSB 500-7	16
AMTS35062	19	AMTT10	17	CSB 250-3	16	CSB 500-7 S	15
AMTS35063	19	AMTT20	17	CSB 250-3 S	15	CSB 500-8	16
AMTS35064	19	AMTT250	17	CSB 250-4	16	CSB 500-8 S	15
AMTS35065	19	AMTTC4	17	CSB 250-4 S	15	CSB 750-10	16
AMTS35066	19	APS02	7	CSB 250-5	16	CSB 750-2	16
AMTS35067	19	APS04	7	CSB 250-5 S	15	CSB 750-3	16
AMTS35068	19	APS06	7	CSB 250-6	16	CSB 750-4	16
AMTS35069	19	APS11	7	CSB 250-6 S	15	CSB 750-5	16
AMTS41410	18	APS21	7	CSB 250-7	16	CSB 750-6	16
AMTS41411	18	APS350	7	CSB 250-7-S	15	CSB 750-7	16
AMTS41412	18	APS41	7	CSB 250-8	16	CSB 750-8	16
AMTS41413	18	APS500	7	CSB 250-8 S	15	CSB 750-9	16
AMTS41414	18	ASL30-21	31	CSB 350-2	16	CSR 2/0	15
AMTS4142	18	ASL60-22	31	CSB 350-2 S	15	CSR 250	15
AMTS4143	18	ASL60-32	31	CSB 350-3	16	CSR 350	15
AMTS4144	18	ASL60-42	32	CSB 350-3 S	15	CSR 500	15
AMTS4145	18	ASL75-22	31	CSB 350-4	16	DBSK82	35
AMTS4146	18	ASL75-32	31	CSB 350-4 S	15	DLC2106	43
AMTS4147	18	ASL75-42	32	CSB 350-5	16	DLC23	43
AMTS4148	18	ASR0214	32	CSB 350-5 S	15	DLC25	43
AMTS4149	18	ASR1114	32	CSB 350-6	16	GP-0	33
AMTS500410	19	ASR2506	32	CSB 350-6 S	15	GP-2	33
AMTS500411	19	ASR3506	32	CSB 350-7	16	GP-250	33

Appendix

Part number index

Cat. no.	Page	Cat. no.	Page	Cat. no.	Page
GP-250-0	33	PDS30500B	25	SP9SS	10
GP-350	33	PDS30500G	25	STC0208	35
GP-500	33	PDS3610	24–25	STC0414	35
GP-750	33	PDS440	24–25	STC0614	35
GT-0	33	PDS440B	25	STC1014	35
GT-2	33	PDS440G	25	STC1102	35
GT-250	33	PDS610	24–25	STC3104	35
GT-250-0	33	PDS610B	25	STC3511	35
GT-350	33	PDS610G	25	STC4102	35
GT-500	33	S100BB	34	STC5011	35
GT-750	33	S225BB	34	STC9960	35
IPC1102	12	S400BB	34	TC-10	33
IPC3535	12	SP0DL	10	TC-2	33
IPC3541	12	SP0DS	10	TC250350	33
IPC4111	12	SP0SL	10	TC-500	33
IPC4141	12	SP0SS	10	TC-750	33
IPC5041	12	SP10DL	10	TL250	34
L1252	34	SP10DS	10	TL250H	34
L1252H	34	SP10SL	10	TL400	34
L125BB	34	SP10SS	10	TL400H	34
L125H	34	SP1DL	10	TL650	34
L250	34	SP1DS	10	TL650H	34
L2502	34	SP1SL	10	UFSK148DB	35
L2502H	34	SP1SS	10	VGC12	11
L250H	34	SP2DL	10	VGC2010	11
L35	34	SP2DS	10	VGC23	11
L4002	34	SP2SL	10	VGC3020	11
L4002H	34	SP2SS	10	VGC4040	11
L400BB	34	SP3DL	10	VGC44	11
L400H	34	SP3DS	10	VGC68	11
L650	34	SP3SL	10	VGC68SH	11
L6502	34	SP3SS	10	XT12	43
L6502H	34	SP4DL	10	XT13	43
L650H	34	SP4DS	10	XT21	43
L70	34	SP4SL	10	XT22	43
PDS22300	24–25	SP4SS	10	XT23	43
PDS22300B	25	SP5DL	10	XT33	43
PDS22300G	25	SP5DS	10	XT34	43
PDS2300	24–25	SP5SL	10		
PDS2300B	25	SP5SS	10		
PDS2300G	25	SP6DL	10		
PDS230500	24–25	SP6DS	10		
PDS230500B	25	SP6SL	10		
PDS230500G	25	SP6SS	10		
PDS2440	24–25	SP8DL	10		
PDS2440B	25	SP8DS	10		
PDS2440G	25	SP8SL	10		
PDS2610	24–25	SP8SS	10		
PDS2610B	25	SP9DL	10		
PDS2610G	25	SP9DS	10		
PDS30500	24–25	SP9SL	10		

Additional information

We reserve the right to make technical changes or modify the contents of this document without prior notice. With regard to purchase orders, the agreed particulars shall prevail. ABB AG does not accept any responsibility whatsoever for potential errors or possible lack of information in this document.

We reserve all rights in this document and in the subject matter and illustrations contained therein. Any reproduction, disclosure to third parties or utilization of its contents – in whole or in parts – is forbidden without prior written consent of ABB AG.



—
US

ABB Installation Products
Electrification business
860 Ridge Lake Blvd.
Memphis, TN 38120
+1 901-252-5000

tnb.abb.com