

Blackburn®

Blackburn® Compression Connectors

In this section...



Blackburn® Compression Connectors

Overview	F-106–F-107
Compression Connectors	F-108–F-120
Aluminum Lugs.....	F-121–F-135
Aluminum Splices.....	F-136–F-144
Tees	F-145–F-150

Thomas&Betts

www.tnb.com

Overview

Type CTL

Copper Short-Barrel Connectors

See pages F-108–F-109

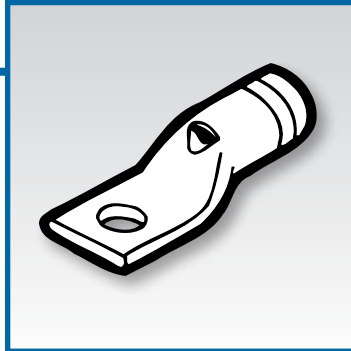

Type CTL-L, LCN

Copper Long-Barrel Connectors

See pages F-110–F-111

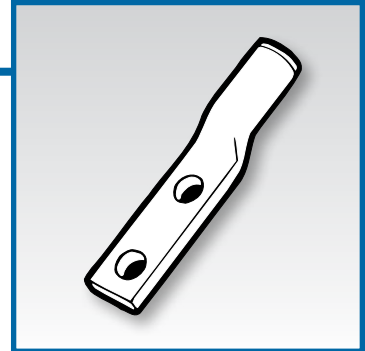

Type CSP, CU

Copper Compression Splices

See pages F-112–F-113

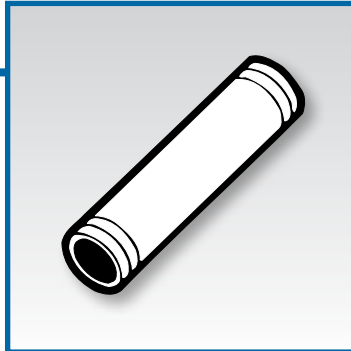

Type PA

Pin Adapter Terminals

See page F-114

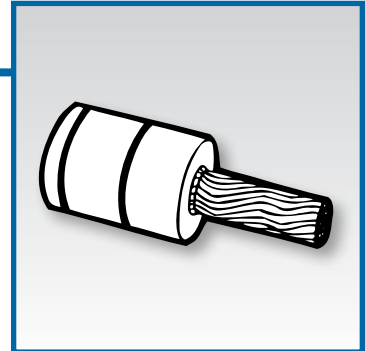

Type ATL

Aluminum Compression Connectors

See pages F-116–F-117

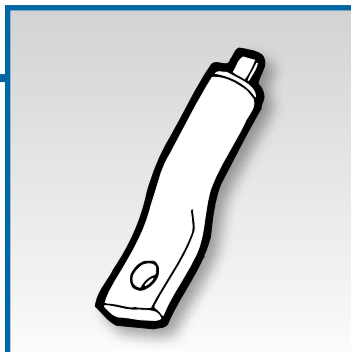

Type ASP

Aluminum Splices

See page F-116

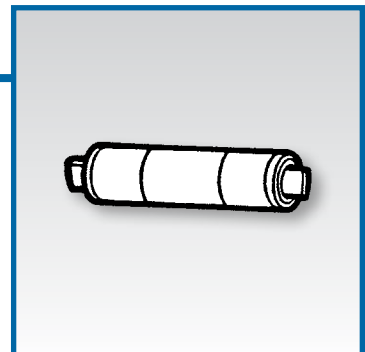

Overview

Aluminum One-Hole NEMA Lugs

See pages F-121, F-125, F-131–F-132

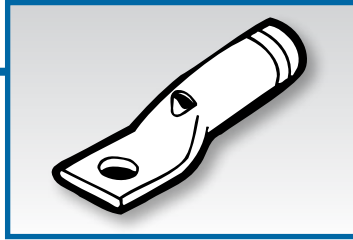

Aluminum Two-Hole NEMA Lugs

See pages F-122–F-123, F-126, F-129

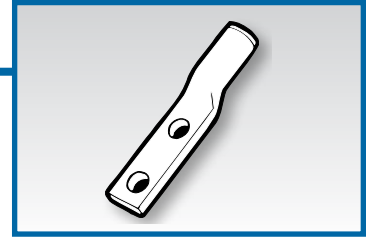

Aluminum Four-Hole NEMA Lugs

See pages F-124, F-130

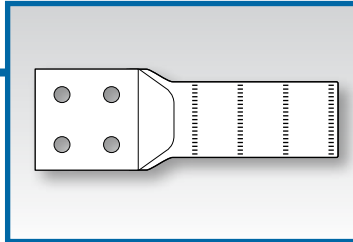

Aluminum Meter Socket Lugs

See pages F-127–F-128

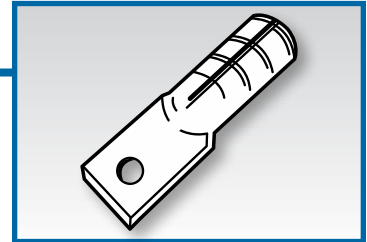

Multi-Range Die-Less, Slotted-Tang Compression and Bi-Metallic Lugs

See pages F-133–F-135

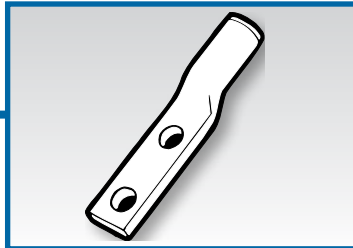

Aluminum Pin Terminals

See page F-133

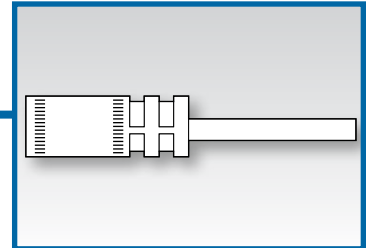

Aluminum Splices

See pages F-136–F-144

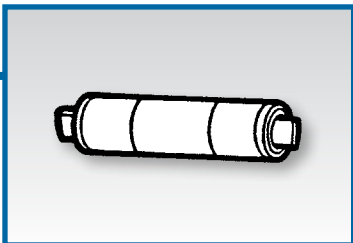

Aluminum and Copper Tees

See pages F-145–F-148

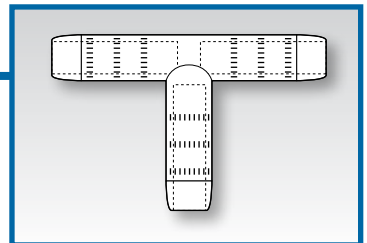

Copper Tin-Plated Clamp Tee Connectors

See page F-149

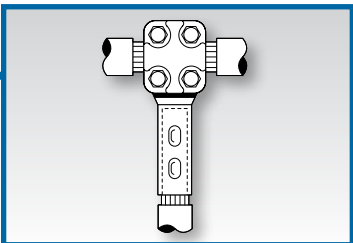

Aluminum and Copper NEMA Lug Tee Taps for Cable Buses

See page F-150

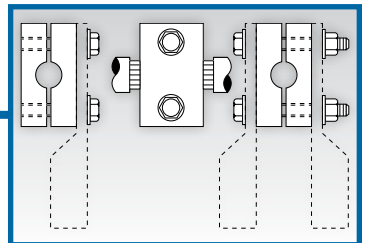

Compression Connectors

Specially designed for industrial and building applications.

Type CTL — Copper One-Hole Lugs, Short Barrel



Copper Compression Connectors

- For use with copper conductor: AWG stranded, flexible cable, welding cable and portable cord
- Specially designed for industrial and building applications
- Made of high-conductivity seamless copper tubing
- Tin plated for corrosion resistance
- Specially chamfered barrel for ease of installation
- Color coded for matching die identification
- Can be used for high-voltage application up to 35kV provided proper high-voltage insulation techniques are used
- UL® Listed for AWG conductor when installed with Blackburn®, Burndy®, T&B® or Anderson tools
- Comply with Subpart 111.60-17 of Federal Register's Coast Guard Electrical Engineering Rules and Regulations

Short-Barrel Connectors

- Designed for regular-duty applications
- Ideal for confined areas

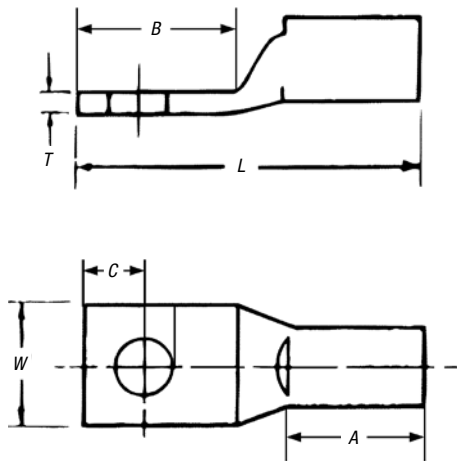

CAT. NO.	CONDUCTOR SIZE (CU)	STUD SIZE	DIMENSIONS (IN.)						DIE COLOR CODE	
			A	B	C	L	W	T		
CTL8-10	#8 Str.	10	1 ¹ / ₃₂	1/2	7/32	1 ¹ / ₃₂	3/8	1/16	RED	
CTL8-14		1/4	1 ¹ / ₃₂	1 ⁹ / ₃₂	1/4	1 ¹ / ₁₆	7/16	1/16		
CTL8-516		5/16	1 ¹ / ₃₂	5/8	9/32	1 ¹ / ₁₆	9/16	1/16		
CTL6-10	#6 Str. or #6 Weld	10	7/16	1 ¹ / ₃₂	7/32	1 ¹ / ₃₂	7/16	1/16	BLUE	
CTL6-14		1/4	7/16	1 ¹ / ₃₂	7/32	1 ¹ / ₃₂	7/16	1/16		
CTL6-516		5/16	7/16	2 ¹ / ₃₂	9/32	1 ¹ / ₃₂	1 ⁹ / ₃₂	1/16		
CTL6-38	#4 Str.	3/8	7/16	2 ¹ / ₃₂	9/32	1 ¹ / ₃₂	1 ⁹ / ₃₂	1/16	GRAY	
CTL4-10		10	1/2	1 ⁹ / ₃₂	1/4	1 ³ / ₈	1 ⁷ / ₃₂	3/32		
CTL4-14		1/4	1/2	1 ⁹ / ₃₂	1/4	1 ³ / ₈	1 ⁷ / ₃₂	3/32		
CTL4-516	#2 Str. or #3 Weld	5/16	1/2	2 ¹ / ₃₂	5/16	1 ¹ / ₃₂	1 ⁹ / ₃₂	1/16	BROWN	
CTL4-38		3/8	1/2	2 ¹ / ₃₂	5/16	1 ¹ / ₃₂	1 ⁹ / ₃₂	1/16		
CTL2-14		1/4	1 ⁹ / ₃₂	2 ¹ / ₃₂	1/4	1 ¹ / ₂	9/16	3/32		
CTL2-516	#1 Str. or #2 Weld	5/16	1 ⁹ / ₃₂	7/8	3/8	1 ²³ / ₃₂	9/16	3/32	GREEN	
CTL2-38		3/8	1 ⁹ / ₃₂	2 ⁹ / ₃₂	3/8	1 ³ / ₄	9/16	3/32		
CTL2-12		1/2	1 ⁹ / ₃₂	1 ¹ / ₁₆	1/2	1 ²⁹ / ₃₂	3/4	1/16		
CTL1-14	#1 Weld	1/4	1 ⁹ / ₃₂	2 ¹ / ₃₂	1/4	1 ¹ / ₂	2 ¹ / ₃₂	3/32	PINK	
CTL1-516		5/16	1 ⁹ / ₃₂	7/8	3/8	1 ²³ / ₃₂	2 ¹ / ₃₂	3/32		
CTL1-38		3/8	1 ⁹ / ₃₂	2 ⁹ / ₃₂	3/32	1 ³ / ₄	2 ¹ / ₃₂	3/32		
CTL1-12	1/0 Str. or #1 Weld	1/2	1 ⁹ / ₃₂	1 ¹ / ₄	1/2	2 ²⁹ / ₃₂	3/4	3/32	BLACK	
CTL10-516		5/16	1 ¹ / ₁₆	7/8	3/8	1 ¹³ / ₁₆	3/4	1/8		
CTL10-38		3/8	1 ¹ / ₁₆	2 ⁹ / ₃₂	3/8	1 ⁷ / ₈	3/4	1/8		
CTL10-12	2/0 Str. or 1/0 Weld	1/2	1 ¹ / ₁₆	1 ¹ / ₄	1/2	2 ²⁹ / ₃₂	3/4	1/8	ORANGE	
CTL20-38		3/8	1 ¹ / ₁₆	2 ⁹ / ₃₂	3/8	2 ¹ / ₃₂	1 ¹ / ₁₆	1/8		
CTL20-12		1/2	1 ¹ / ₁₆	1 ¹ / ₄	1/2	2 ¹¹ / ₃₂	1 ¹ / ₁₆	1/8		
CTL30-38	3/0 Str. or 2/0 Weld	3/8	1 ¹ / ₁₆	2 ⁹ / ₃₂	3/8	2 ¹ / ₃₂	2 ⁹ / ₃₂	1/8	PURPLE	
CTL30-12		1/2	1 ¹ / ₁₆	1 ¹ / ₄	1/2	2 ¹¹ / ₃₂	2 ⁹ / ₃₂	1/8		
CTL40-38		3/8	1 ¹ / ₁₆	2 ⁹ / ₃₂	3/8	2 ⁵ / ₃₂	1 ¹ / ₃₂	1/8		
CTL40-12	4/0 Str. or 3/0 Weld	1/2	1 ⁹ / ₁₆	1 ¹ / ₄	1/2	2 ¹ / ₂	1 ¹ / ₃₂	1/8	YELLOW	
CTL250-12		250 kcmil or 4/0 Weld	1/2	1 ¹ / ₃₂	1 ¹ / ₄	1/2	2 ¹⁹ / ₃₂	1 ¹ / ₈		1/8
CTL300-12		300 kcmil	1/2	1 ¹ / ₃₂	1 ¹ / ₄	1/2	2 ²⁵ / ₃₂	1 ¹ / ₁₆		5/32
CTL350-12	350 kcmil	1/2	1 ¹ / ₃₂	1 ¹ / ₄	1/2	2 ²⁵ / ₃₂	1 ¹¹ / ₃₂	5/32	RED	
CTL400-12	400 kcmil	1/2	1 ¹ / ₃₂	1 ¹ / ₄	1/2	3 ¹ / ₁₆	1 ¹ / ₃₂	5/32	BLUE	
CTL400-58		5/8	1 ¹ / ₃₂	1 ¹ / ₁₆	5/8	3 ¹ / ₂	1 ¹ / ₃₂	5/32		
CTL500-12	500 kcmil	1/2	1 ¹ / ₃₂	1 ¹ / ₄	1/2	3 ¹ / ₄	1 ¹⁹ / ₃₂	7/32	BROWN	
CTL500-58		5/8	1 ¹ / ₃₂	1 ¹ / ₁₆	5/8	3 ³ / ₁₆	1 ¹⁹ / ₃₂	7/32		
CTL600-58	600 kcmil	3/8	1 ¹ / ₁₆	1 ¹ / ₁₆	3/8	3 ²³ / ₃₂	1 ³ / ₄	1/2	GREEN	
CTL750-58	750 kcmil	3/8	1 ¹ / ₂	1 ¹ / ₁₆	3/8	3 ²⁵ / ₃₂	1 ²⁹ / ₃₂	5/32	BLACK	
CTL1000-58	1,000 kcmil	3/8	1 ¹ / ₄	1 ¹ / ₁₆	3/8	4 ¹ / ₃₂	2 ¹ / ₄	5/32	N/A	

Compression Connectors

Ideal for use in confined areas.

Type CTL — Copper Two-Hole Lugs, Short Barrel

Copper Compression Connectors

- For use with copper conductor: AWG stranded, flexible cable, welding cable and portable cord
- Specially designed for industrial and building applications
- Made of high-conductivity seamless copper tubing
- Tin plated for corrosion resistance
- Specially chamfered barrel for ease of installation
- Color coded for matching die identification
- Can be used for high-voltage application up to 35kV provided proper high-voltage insulation techniques are used
- UL® Listed for AWG conductor when installed with Blackburn®, Burndy®, T&B® or Anderson tools
- Comply with Subpart 111.60-17 of Federal Register's Coast Guard Electrical Engineering Rules and Regulations

Short-Barrel Connectors

- Designed for regular-duty applications
- Ideal for confined areas

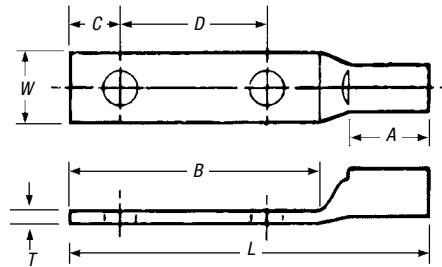

CAT. NO.	CONDUCTOR SIZE (CU)	STUD SIZE	DIMENSIONS (IN.)							DIE COLOR CODE	
			A	B	C	D	L	W	T		
CTL6-214	#6 Str. or #6 Weld	1/4	1/2	1/4	1/4	5/8	1 3/32	1 3/32	1/16	BLUE	
CTL4-214	#4 Str. or #4 Weld		1/2	1/4	1/4	5/8	2 1/32	1/2	3/32	GRAY	
CTL2-2516	#2 Str. or #3 Weld	5/16	1 9/32	1 5/8	3/8	3/4	2 15/32	9/16	3/32	BROWN	
CTL1-2516	#1 Str. or #2 Weld		1 9/32	1 3/4	3/8	7/8	2 19/32	2 1/32	3/32	GREEN	
CTL10-2516	1/0 Str. or #1 Weld		1 11/16	1 3/4	3/8	7/8	2 11/16	3/4	1/8	PINK	
CTL202	2/0 Str. or 1/0 Weld	1/2	1 3/16	2 13/16	1/2	1 3/4	3 13/16	1 3/16	1/8	BLACK	
CTL302	3/0 Str. or 2/0 Weld		2 5/32	2 13/16	1/2	1 3/4	3 15/16	1 5/16	1/8	ORANGE	
CTL402	4/0 Str. or 3/0 Weld		1 5/16	3	1/2	1 3/4	4 1/4	1 3/32	1/8	PURPLE	
CTL2502	250 kcmil or 4/0 Weld		1 11/32	3	1/2	1 3/4	4 11/32	1 1/8	5/32	YELLOW	
CTL3002	300 kcmil		1 11/32	3	1/2	1 3/4	4 17/32	1 1/16	5/32	WHITE	
CTL3502	350 kcmil		1 11/32	3	1/2	1 3/4	4 17/32	1 11/32	5/32	RED	
CTL4002	400 kcmil		1 11/32	3	1/2	1 3/4	4 15/16	1 13/32	5/32	BLUE	
CTL5002	500 kcmil		1 3/8	3	1/2	1 3/4	5	1 11/32	7/32	BROWN	
CTL6002-38	600 kcmil		3/8	1 17/32	1 29/32	3/8	1 3/4	5 1/8	1 23/32	7/32	GREEN
CTL6002-12	600 kcmil		1/2	1 17/32	3	1/2	1 3/4	5 1/8	1 23/32	7/32	GREEN
CTL7502	750 kcmil	1 1/2		3	1/2	1 3/4	5 7/32	1 29/32	1/4	BLACK	
CTL10002	1000 kcmil	1 3/4		3	1/2	1 3/4	5 7/32	2 1/4	9/32	N/A	

Compression Connectors

Ideal for industrial, oil rig, mining, welding and transportation electrical termination applications.

Type CTL-L — Copper One-Hole Lugs, Long Barrel

Copper Compression Connectors

- For use with copper conductor: AWG stranded, flexible cable, welding cable and portable cord
- Specially designed for industrial and building applications
- Made of high-conductivity seamless copper tubing
- Tin plated for corrosion resistance
- Specially chamfered barrel for ease of installation
- Color coded for matching die identification
- Can be used for high-voltage application up to 35kV provided proper high-voltage insulation techniques are used
- UL® Listed for AWG conductor when installed with Blackburn®, Burndy®, T&B® or Anderson tools

- Comply with Subpart 111.60-17 of Federal Register's Coast Guard Electrical Engineering Rules and Regulations

Long-Barrel Connectors

- Ideal for industrial, oil rig, mining, welding and transportation electrical termination applications
- Heavy-duty design permits additional crimp for added mechanical strength

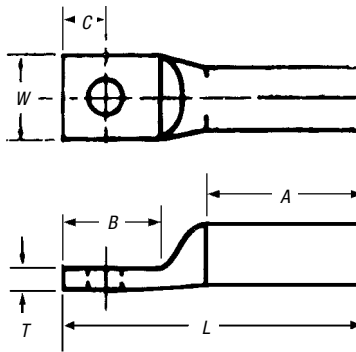

CAT. NO.	CONDUCTOR SIZE	FLEXIBLE CONDUCTOR	STRANDING	STUD	DIMENSIONS (IN.)						DIE COLOR
					A	B	C	L	W	T	
CTL8L-14	#8 Str.	#8	37/24		29/32	5/8	1/4	1 1/8	1 3/32	1/16	RED
CTL6L-14	#6 Str.	#6	61/24	1/4	25/32	5/8	1/4	1 1/8	1 3/32	1/16	BLUE
CTL4L-14	#4 Str.	#5	91/24		25/32	5/8	1/4	1 11/16	1/2	3/32	GRAY
CTL2L-516	#2 Str.	#3	125/24		7/8	7/8	3/8	2 1/2	9/16	3/32	BROWN
CTL1L-516	#1 Str.	#2	150/24	5/16	13/32	7/8	3/8	2 3/32	2 1/32	3/32	GREEN
CTL10L-516	1/0 Str.	#1	225/24		13/32	7/8	3/8	2 7/32	3/4	1/8	PINK
CTL20L-38	2/0 Str.	1/0	275/24	3/8	13/32	29/32	3/8	2 1/4	1 3/16	1/8	BLACK
CTL30L-12	3/0 Str.	2/0	325/24		1 1/8	1 1/4	1/2	2 1/16	2 3/32	1/8	ORANGE
CTL40L-12	4/0 Str.	—	—		1 3/8	1 1/4	1/2	2 15/16	1 1/32	1/8	PURPLE
CTL250L-12	250 kcmil	3/0	450/24	1/2	1 19/32	1 1/4	1/2	3 3/8	1 1/8	1/8	YELLOW
CTL300L-12	300 kcmil	4/0	550/24		1 25/32	1 1/4	1/2	3 17/32	1 3/16	1/8	WHITE
CTL350L-12	350 kcmil	263 kcmil	650/24		1 27/32	1 1/4	1/2	3 13/32	1 11/32	5/32	RED
CTL400L-58	400 kcmil	313 kcmil	775/24		1 27/32	1 1/16	5/8	4 1/2	1 13/32	5/32	BLUE
CTL500L-58	500 kcmil	373 kcmil	925/24		2 11/32	1 1/16	5/8	4 1/2	1 19/32	3/16	BROWN
CTL600L-58	600 kcmil	444 kcmil	1100/24		2 1/8	1 1/16	5/8	4 5/16	1 23/32	7/32	GREEN
CTL750L-58	750 kcmil	535 kcmil	1325/24	5/8	2 3/8	1 1/16	5/8	4 21/32	1 29/32	1/4	BLACK
CTL1000L-58	1000 kcmil	646 kcmil	1600/24		2 7/8	1 1/16	5/8	5 1/2	2 1/4	5/32	N/A
		777 kcmil	1925/24								

Compression Connectors

Made of high-conductivity seamless copper tubing, tin plated for corrosion resistance.

Type LCN — Copper Two-Hole Lugs, Long Barrel



Copper Compression Connectors

- For use with copper conductor: AWG stranded, flexible cable, welding cable and portable cord
- Specially designed for industrial and building applications
- Made of high-conductivity seamless copper tubing
- Tin plated for corrosion resistance
- Specially chamfered barrel for ease of installation
- Color coded for matching die identification
- Can be used for high-voltage application up to 35kV provided proper high-voltage insulation techniques are used

- UL® Listed for AWG conductor when installed with Blackburn®, Burndy®, T&B® or Anderson tools
- Comply with Subpart 111.60-17 of Federal Register's Coast Guard Electrical Engineering Rules and Regulations

Long-Barrel Connectors

- Ideal for industrial, oil rig, mining, welding and transportation electrical termination applications
- Heavy-duty design permits additional crimp for added mechanical strength

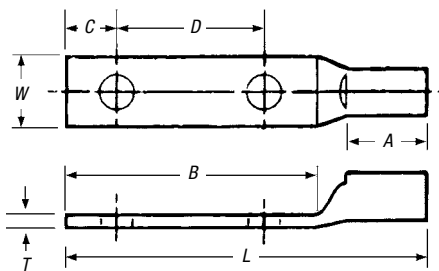

CAT. NO.	CONDUCTOR SIZE (CU)	FLEXIBLE CONDUCTOR SIZE	STRANDING	STUD SIZE	DIMENSIONS (IN.)							DIE COLOR CODE
					A	B	C	D	L	W	T	
LCN8-14	#8 Str.	#8	37/24	1/4	25/32	1 1/16	1/4	5/8	2 1/8	1 5/32	1/16	RED
LCN6-14	#6 Str.	#6	61/24		25/32	1 1/4	1/4	5/8	2 1/4	1 3/32	1/16	BLUE
LCN6-12	#6 Str.	#6	61/24	1/2	25/32	3	1/2	1 3/4	4 5/32	7/8	3/32	GRAY
LCN4-14	#4 Str.	#5	91/24	1/4	25/32	1 3/16	1/4	5/8	2 3/16	1 7/32	3/16	BROWN
LCN4-12	#4 Str.	#5	91/24		1/2	25/32	3	1/2	1 3/4	4 3/32	7/8	
LCN2-516	#2 Str.	#3	125/24	5/16	7/8	1 5/8	3/8	3/4	2 15/16	9/16	3/32	GREEN
LCN2-12	#2 Str.	#3	125/24	1/2	7/8	3	1/2	1 3/4	4 1/4	7/8	3/32	PINK
LCN1-516	#1 Str.	#2	150/24	5/16	1 1/32	1 5/8	3/8	7/8	2 31/32	2 1/32	3/32	BLACK
LCN1-12	#1 Str.	#2	150/24	1/2	1 1/32	3	1/2	1 3/4	4 13/32	7/8	3/32	ORANGE
LCN10	1/0	#1	225/24		1 1/32	3	1/2	1 3/4	3 31/32	3/4	1/8	PURPLE
LCN20	2/0	1/0	275/24	3/4	1 9/16	3	1/2	1 3/4	4 3/16	1 3/16	1/8	YELLOW
LCN30	3/0	2/0	325/24		1 1/8	2 15/16	1/2	1 3/4	4 1/16	1 5/16	1/8	WHITE
LCN40	4/0	—	—	1/2	1 19/32	3	1/2	1 3/4	4 29/32	1 1/16	1/8	RED
LCN250	250 kcmil	3/0	450/24		1 25/32	3	1/2	1 3/4	5 3/32	1 3/16	1/8	BLUE
LCN300	300 kcmil	4/0	550/24	1/2	1 21/32	3	1/2	1 3/4	5 1/16	1 13/32	5/32	BROWN
LCN350	350 kcmil	263 kcmil	650/24		1 27/32	3	1/2	1 3/4	5 5/16	1 13/32	1/8	GREEN
LCN400	400 kcmil	313 kcmil	775/24	1/2	2 11/32	3	1/2	1 3/4	5 15/16	1 19/32	3/16	BLACK
LCN500	500 kcmil	373 kcmil	925/24		2 1/8	3	1/2	1 3/4	6 3/32	1 29/32	1/4	N/A
LCN600	600 kcmil	444 kcmil	1100/24	1/2	2 3/8	3	1/2	1 3/4	6 3/32	1 29/32	1/4	N/A
LCN75	750 kcmil	535 kcmil	1325/24		2 3/8	3	1/2	1 3/4	6 3/32	1 29/32	1/4	N/A
LCN99	1000 kcmil	646 kcmil 777 kcmil	1600/24 1925/24	1/2	2 7/8	3	1/2	1 3/4	6 19/32	2 1/4	9/32	N/A

Compression Connectors

Designed for regular-duty applications.

Type CSP — Copper Splices, Short Barrel

Copper Compression Connectors

- For use with copper conductor: AWG stranded, flexible cable, welding cable and portable cord
- Specially designed for industrial and building applications
- Made of high-conductivity seamless copper tubing
- Tin plated for corrosion resistance
- Specially chamfered barrel for ease of installation
- Color coded for matching die identification
- Can be used for high-voltage application up to 35kV provided proper high-voltage insulation techniques are used
- UL® Listed for AWG conductor when installed with Blackburn®, Burndy®, T&B® or Anderson tools
- Comply with Subpart 111.60-17 of Federal Register's Coast Guard Electrical Engineering Rules and Regulations

Short-Barrel Connectors

- Designed for regular-duty applications
- Ideal for confined areas

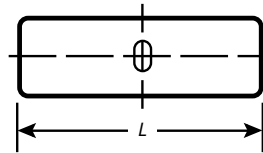

CAT. NO.	CONDUCTOR SIZE (CU)	LENGTH L (IN.)	DIE COLOR CODE
CSP8	#8 Str. AWG	1	RED
CSP6	#6 Str. AWG	1	BLUE
CSP4	#4 Str. AWG	1	GRAY
CSP2	#3-2 Str. AWG	1¼	BROWN
CSP1	#1 Str. AWG	1½	GREEN
CSP10	1/0 Str. AWG	1½	PINK
CSP20	2/0 Str. AWG	1¾	BLACK
CSP30	3/0 Str. AWG	1¾	ORANGE
CSP40	4/0 Str. AWG	1¾	PURPLE
CSP250	250 kcmil	2¼	YELLOW
CSP300	300 kcmil	2½	WHITE
CSP350	350 kcmil	2¼	RED
CSP400	400 kcmil	2¾	BLUE
CSP500	500 kcmil	2¾	BROWN
CSP600	600 kcmil	3	GREEN
CSP750	750 kcmil	3	BLACK
CSP1000	1000 kcmil	3½	N/A

Compression Connectors

Heavy-duty design permits additional crimp for added mechanical strength.

Type CU — Copper Splices, Long Barrel

Copper Compression Connectors

- For use with copper conductor: AWG stranded, flexible cable, welding cable and portable cord
- Specially designed for industrial and building applications
- Made of high-conductivity seamless copper tubing
- Tin plated for corrosion resistance
- Specially chamfered barrel for ease of installation
- Color coded for matching die identification
- Can be used for high-voltage application up to 35kV provided proper high voltage insulation techniques are used
- UL® Listed for AWG conductor when installed with Blackburn®, Burndy®, T&B® or Anderson tools
- Comply with Subpart 111.60-17 of Federal Register's Coast Guard Electrical Engineering Rules and Regulations

Long-Barrel Connectors

- Ideal for industrial, oil rig, mining, welding and transportation electrical termination applications
- Heavy-duty design permits additional crimp for added mechanical strength

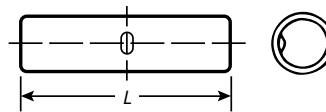

CAT. NO.	CONDUCTOR SIZE (CU)	FLEXIBLE CONDUCTOR		LENGTH L (IN.)	DIE COLOR CODE
		CMA	STRANDING		
CU8	#8 Str. AWG	8	37/24	1¾	RED
CU6	#6 Str. AWG	6	61/24		BLUE
CU4	#4 Str. AWG	5	91/24	1½	GRAY
CU2	#2 Str. AWG	3	125/24		BROWN
CU1	#1 Str. AWG	2	150/24	2	GREEN
CU10	1/0 Str. AWG	1	225/24		PINK
CU20	2/0 Str. AWG	1/0	275/24	2½	BLACK
CU30	3/0 Str. AWG	2/0	325/24	2¾	ORANGE
CU40	4/0 Str. AWG	—	—	2¾	PURPLE
CU250	250 kcmil	3/0	450/24	3¾	YELLOW
CU300	300 kcmil	4/0	550/24	3½	WHITE
CU350	350 kcmil	263	650/24	3¾	RED
CU400	400 kcmil	313	755/24		BLUE
CU500	500 kcmil	373	925/24	4¾	BROWN
CU600	600 kcmil	444	1100/24	4¾	GREEN
CU750	750 kcmil	535	1325/24	4¾	BLACK
CU1000	1000 kcmil	646	1600/24	5%	N/A
		777	1925/24		

Compression Connectors

Insulating covers included.

Type PA — Pin Adapter Terminals

- Connector for aluminum conductor only
- Pigtail may be inserted into either aluminum or copper connectors
- 90° C rating per UL® 486B
- Tin-plated stranded copper wire pigtail
- Tin-plated aluminum barrel prefilled with oxide inhibitor and capped

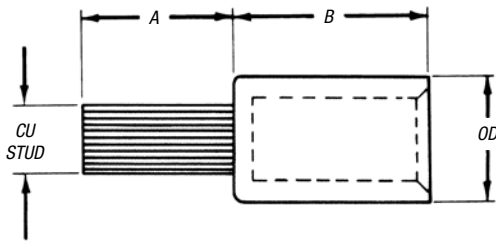
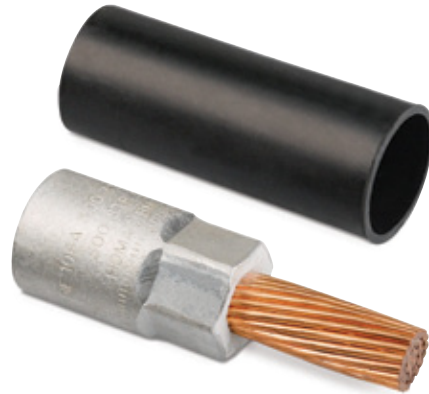

CAT. NO.	CONDUCTOR SIZE	COPPER STUD SIZE	DIMENSIONS (IN.)			DIE COLOR CODE
			A	B	O.D.	
PA06	#6 Str. AWG	8	7/8	1 11/32	.640	N/A
PA04	#4 Str. AWG	6	7/8	1 11/32	.640	
PA02	#2 Str. AWG	4	7/8	1 11/32	.640	
PA01	#1 Str. AWG	3	1	1 11/32	.640	
PA11	1/0 Str. AWG	2	1 1/4	1 19/32	.906	RED
PA21	2/0 Str. AWG	1	1 7/8	1 19/32	.906	
PA31	3/0 Str. AWG	1/0	1 3/8	1 7/8	.906	
PA41	4/0 Str. AWG	2/0	1 3/8	1 7/8	.906	BROWN
PA25	250 kcmil	3/0	1 1/2	2 1/16	1.155	
PA30	300 kcmil	4/0	1 3/8	2 1/16	1.155	
PA35	350 kcmil	4/0	1 3/8	2 1/16	1.155	
PA40	400 kcmil	250 kcmil	1 3/8	2 3/32	1.375	PINK
PA50	500 kcmil	350 kcmil	1 3/8	2 3/32	1.375	
PA60	600 kcmil	350 kcmil	1 3/8	2 3/4	1.500	YELLOW
PA75	750 kcmil	500 kcmil	2	2 3/4	1.500	

Compression Connectors

Use with aluminum or copper conductor.

Type ATL — Aluminum One-Hole Lugs

- Specifically designed for use with aluminum conductor (concentric, compressed or compact)
- Also listed for use with copper conductor
- Made of high-conductivity seamless aluminum tubing
- Tin plated for corrosion resistance
- Chamfered barrels for ease of installation
- Can be used for high-voltage application up to 35kV, provided high-voltage insulation techniques are used
- Color coded for quick, easy die identification
- Prefilled with oxide-inhibiting compound
- UL® Listed when installed with Blackburn®, Burndy®, T&B® or Anderson tools

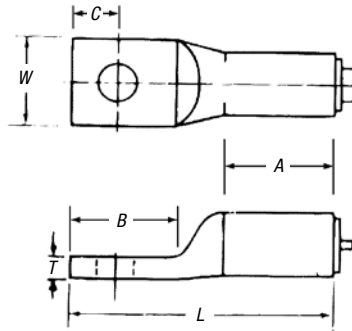

CAT. NO.	CONDUCTOR SIZE (AL OR CU)	STUD SIZE	DIMENSIONS (IN.)						DIE COLOR CODE
			A	B	C	L	W	T	
ATL8-10		10	1/2	19/32	7/32	1 1/2	1 1/2	3/32	BLUE
ATL8-14	#8 Str. AWG	1/4	1/2	1 1/16	1 1/32	1 3/8	7/16	3/32	
ATL6-10		10	25/32	9/16	7/32	1 1/2	15/32	1/8	GRAY
ATL6-14	#6 Str. AWG	1/4	25/32	23/32	15/32	1 21/32	15/32	1/8	
ATL6-38		3/8	27/32	29/32	7/16	1 27/32	5/8	3/32	GREEN
ATL4-14		1/4	27/32	13/16	1 1/32	1 29/32	3/8	3/16	
ATL4-516	#4 Str. AWG	3/16	27/32	1	7/16	2 1/16	3/8	3/16	GREEN
ATL4-38		3/8	27/32	29/32	7/16	2	3/8	3/16	
ATL2-14		1/4	27/32	25/32	1 1/32	1 15/16	2 3/32	3/16	PINK
ATL2-516	#2 Str. AWG	5/16	27/32	7/8	7/16	2 11/32	3/4	3/16	
ATL2-38		3/8	27/32	29/32	7/16	2 1/16	2 3/32	3/16	GOLD
ATL1-516	#1 Str. AWG	5/16	27/32	7/8	7/16	2 1/32	2 3/32	3/16	
ATL1-38		3/8	27/32	29/32	7/16	2 3/8	3/4	3/16	TAN
ATL10-516		5/16	1 3/32	1	7/16	2 17/32	7/8	3/16	
ATL10-38	1/0 Str. AWG	3/8	1 3/32	1 1/16	7/16	2 9/32	7/8	3/16	OLIVE
ATL10-12		1/2	1 3/32	1 3/8	1 1/16	2 5/16	1 5/16	3/16	
ATL20-38	2/0 Str. AWG	3/8	1 3/16	1	7/16	2 5/8	3 1/32	7/32	RUBY
ATL20-12		1/2	1 3/16	1 3/8	1 1/16	3	1 1/32	7/32	
ATL30-38	3/0 Str. AWG	3/8	1 11/32	1 1/16	7/16	2 3/16	1 1/16	7/32	WHITE
ATL30-12		1/2	1 11/32	1 3/8	1 1/16	3 3/8	1 1/16	7/32	
ATL40-38	4/0 Str. AWG	3/8	1 7/8	1 3/32	3/8	3 3/4	1 3/16	1/4	RED
ATL40-12		1/2	1 7/8	1 1/4	1/2	3 3/8	1 3/16	1/4	
ATL250-12	250 kcmil	1/2	2 1/32	1 1/4	1/2	4 1/32	1 9/32	1/4	BLUE
ATL300-38	300 kcmil	3/8	2	1 5/16	3/8	4 3/16	1 3/8	9/32	
ATL300-12		1/2	2	1 5/16	1/2	4 3/16	1 3/8	9/32	BROWN
ATL350-12	350 kcmil	1/2	2 11/16	1 5/16	1/2	4 7/8	1 1/2	5/16	
ATL400-58	400 kcmil	5/8	2 11/16	1 1/4	1/2	4 5/16	1 5/8	3/8	GREEN
ATL500-12	500 kcmil	1/2	2 11/16	1 1/4	1/2	4 5/16	1 25/32	3/8	
ATL500-58		5/8	2 11/16	2	3/4	5 11/16	1 25/32	3/8	PINK
ATL600-12	600 kcmil	1/2	2 11/16	2	3/4	5 13/16	1 29/32	11/32	
ATL750-12	750 kcmil	1/2	2 7/8	1 1/4	1/2	5 1/4	2 1/8	3/8	BLACK
ATL750-58		5/8	2 7/8	2	3/4	6 1/32	2 1/8	3/8	

Compression Connectors

Made of high-conductivity seamless aluminum tubing, tin plated for corrosion resistance.

Type ATL — Aluminum Two-Hole Lugs

- Specifically designed for use with aluminum or copper conductor (concentric, compressed or compact)
- Made of high-conductivity seamless aluminum tubing
- Tin plated for corrosion resistance
- Chamfered barrels for ease of installation
- Can be used for high-voltage application up to 35kV, provided high-voltage insulation techniques are used
- Color coded for quick, easy die identification
- Prefilled with oxide-inhibiting compound
- UL® Listed when installed with Blackburn®, Burndy®, T&B® or Anderson tools

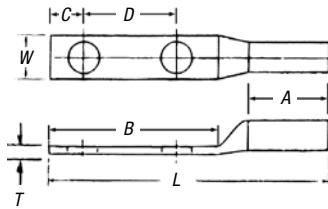

CAT. NO.	CONDUCTOR SIZE (CU)	STUD SIZE	DIMENSIONS (IN.)							DIE COLOR CODE
			A	B	C	D	L	W	T	
ATL102-38	1/0 Str. AWG	3/8	1 1/32	2 1/16	3/8	1	3 13/32	7/8	3/16	TAN
ATL102	1/0 Str. AWG	1/2	1 1/16	3	1/2	1 1/4	4 1/16	1 1/16	3/16	OLIVE
ATL202	2/0 Str. AWG		1 1/16	3 3/8	3/4	1 1/4	5	3 1/32	7/32	RUBY
ATL302	3/0 Str. AWG		1 1/32	3 3/8	3/4	1 1/4	5 5/32	1 1/16	7/32	WHITE
ATL402	4/0 Str. AWG		1 1/8	3	1/2	1 1/4	5 1/2	1 3/16	1/4	RED
ATL2502	250 kcmil		2 1/32	3	1/2	1 1/4	5 25/32	1 1/32	1/4	BLUE
ATL3002	300 kcmil		2	3	1/2	1 1/4	5 1/2	1 3/8	3/32	BROWN
ATL3502	350 kcmil		2 1/16	3	1/2	1 1/4	6 1/16	1 1/2	3/16	GREEN
ATL4002	400 kcmil		2 1/16	3	1/2	1 1/4	6 1 1/16	1 5/8	3/8	PINK
ATL5002	500 kcmil		2 1/16	3	1/2	1 1/4	6 1 1/16	1 25/32	3/8	BLACK
ATL6002	600 kcmil		2 1/16	3	1/2	1 1/4	6 1 1/16	1 29/32	1 1/32	N/A
ATL7502	750 kcmil	2 3/8	3	1/2	1 1/4	7 1/8	2 1/8	3/8	N/A	

Chamfered barrels enable easier installation.

Type ASP – Aluminum Splices

- Specifically designed for use with aluminum-to-aluminum, aluminum-to-copper or copper-to-copper conductor (concentric, compressed or compact)
- Made of high-conductivity seamless aluminum tubing
- Tin plated for corrosion resistance
- Chamfered barrels for ease of installation
- Can be used for high-voltage application up to 35kV, provided high-voltage insulation techniques are used
- Color-coded for quick, easy die identification
- Prefilled with oxide-inhibiting compound
- UL® Listed when installed with Blackburn®, Burndy®, T&B® or Anderson tools

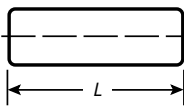

CAT. NO.	CONDUCTOR SIZE (AL OR CU)	LENGTH L (IN.)	DIE COLOR CODE
ASP8	#8 Str. AWG	1 1/4	BLUE
ASP6	#6 Str. AWG	1 1/8	GRAY
ASP4	#4 Str. AWG	1 1/8	GREEN
ASP2	#2 Str. AWG	1 1/8	PINK
ASP1	#1 Str. AWG	2 3/8	GOLD
ASP10	1/0 Str. AWG	2 3/8	TAN
ASP20	2/0 Str. AWG	2 1/2	OLIVE
ASP30	3/0 Str. AWG	2 1/2	RUBY
ASP40	4/0 Str. AWG	3 3/4	WHITE
ASP250	250 kcmil	4	RED
ASP300	300 kcmil	4	BLUE
ASP350	350 kcmil	3 3/8	BROWN
ASP400	400 kcmil	4 1/8	GREEN
ASP500	500 kcmil	5	PINK
ASP600	600 kcmil	5 1/8	BLACK
ASP750	750 kcmil	5 1/8	BLACK
ASP1000	1,000 kcmil	6	N/A

Compression Connectors

Tool and Die Index for Short Barrel — Types CTL, CTL-2 and CSP

COPPER STRAND WIRE SIZE	DIE COLOR CODE	BLACKBURN® TOOLS						BURNDY® TOOLS				T&B® TOOLS					ANDERSON TOOLS				
		CRIMPS		MECH.	CRIMPS	CRIMPS	CRIMPS	CRIMPS	HYD.	CRIMPS	CRIMPS	CRIMPS	CRIMPS	CRIMPS	CRIMPS	CRIMPS	CRIMPS	CRIMPS	CRIMPS	CRIMPS	
		MECH. OD58	PER END	NRG 2506	PER END	HYD. JB12B•	PER END	MECH. MY29-3	PER END	HYD. Y35, Y39, Y46	PER END	MECH. TBM5S	PER END	MECH. TBM8S	PER END	HYD. TBM15	PER END	CU WIRE RANGE	VC6† VC6FT	VC7† VC7FT	VC8C†† VC8C††
8	RED	7/32	3	**	1	B71CH	1	**	1			13454	2	13461	2	21	2				
6	BLUE	J 1/4	3	**	1	B73CH	1	**	1	U5CRT	2	13454	2	13461	2	24	2				
4	GRAY	5/16	3	**	1	B74CH	1	**	1	U4CRT	2	13454	2	13461	2	29	2				
3	WHITE			**	2			**	2	U3CRT	2										
2	BROWN	3/8	4	**	2	B75CH	1	**	2	U2CRT	2	13454	2	13461	2	33	2	6-2	1*	2	
1	GREEN	P	4	**	2	B05CH	1	**	2	U1CRT	2	13455	3	13462	3	37	2	6-1	1	2	
1/0	PINK	1/2	4	**	2	B06CHI	2	**	2	U25RT	2	13455	3	13462	3	42H	3	6-1/0	1	2	
2/0	BLACK	17/32	4	**	2	B72CH	1	**	2	U26RT	2	13455	3	13462	3	45	2	4-2/0	1	2	
3/0	ORANGE	9/16	4	**	2	B08CH	1	**	2	U27RT	2	13455	4	13462	4	50	2	2-3/0	2	2	
4/0	PURPLE	5/8-1	4	**	2	B09CH	2	**	2	U28RT	2	13456	4	13463	4	54H	3	1-4/0	2	2	
250	YELLOW	11/16	4	**	2	B26CH	2	**	2	U29RT	2	13456	4	13463	4	62	2	1/0-250†	2	2	
300	WHITE					B10CHI B10CH	2			U30RT	2			13465	4	66	2	2/0-300†	2	2	
350	RED					B11CH	2			U31RT	2			13465	4	71H	3	3/0-350†	2	3	
400	BLUE					B11CH	2			U32RT	3			13467	4	76	2	4/0-400†	2	3	
500	BROWN					B12CHI B12CH	2			U34RT	3			13468	5	87H	3	4/0-500V	2	3	
600	GREEN					B36CH¹	3			U36RT³	3				94H	3	250-600		3 VC7FT only		
750	BLACK					B39CH¹ 6039RT²	3 1			U39RT³	3				106H	3	500-750		4 VC7FT only	2	
1000	—					6044RT²	1			P44RT⁴	4				125H	4	750-1000			2	

Tool and Die Index for Long Barrel — Types CTL-L, LCN and CU

COPPER STRAND WIRE SIZE	DIE COLOR CODE	BLACKBURN® TOOLS						BURNDY® TOOLS				T&B® TOOLS					ANDERSON TOOLS				
		CRIMPS		MECH.	CRIMPS	CRIMPS	CRIMPS	CRIMPS	HYD.	CRIMPS	CRIMPS	CRIMPS	CRIMPS	CRIMPS	CRIMPS	CRIMPS	CRIMPS	CRIMPS	CRIMPS	CRIMPS	CRIMPS
		MECH. OD58	PER END	NRG 2506	PER END	HYD. JB12B•	PER END	MECH. MY29-3	PER END	HYD. Y35, Y39, Y46	PER END	MECH. TBM5S	PER END	MECH. TBM8S	PER END	HYD. TBM15	PER END	CU WIRE RANGE	VC6† VC6FT	VC7† VC7FT	VC8C†† VC8C††
8	RED	7/32	4	**	2	B71CH	2	**	2			13454	2	13461	2	21	3				
6	BLUE	J 1/4	4	**	2	B73CH	2	**	2	U5CRT	2	13454	2	13461	2	24	3				
4	GRAY	5/16	4	**	2	B74CH	2	**	2	U4CRT	2	13454	2	13461	2	29	3				
3	WHITE			**	3			**	3	U3CRT	2										
2	BROWN	3/8	5	**	3	B75CH	2	**	3	U2CRT	2	13454	2	13461	2	33	3	6-2	2	4	
1	GREEN	P	5	**	3	B05CH	2	**	3	U1CRT	2	13455	4	13462	3	37	3	6-1	2	5	
1/0	PINK	1/2	5	**	3	B06CHI	2	**	3	U25RT	2	13455	4	13462	4	42H	4	6-1/0	2	5	
2/0	BLACK	17/32	5	**	3	B72CH	2	**	3	U26RT	2	13455	4	13462	4	45	3	4-2/0	2	5	
3/0	ORANGE	9/16	5	**	4	B08CH	2	**	4	U27RT	3	13455	6	13462	6	50	3	2-3/0	3	6	
4/0	PURPLE	5/8-1	6	**	4	B09CH	3	**	4	U28RT	3	13456	6	13463	6	54H	5	1-4/0	3	6	
250	YELLOW	11/16	6	**	4	B26CH	3	**	4	U29RT	3	13456	6	13463	6	62	3	1/0-250	3	6	
300	WHITE					B10CHI B10CH	3			U30RT	3			13465	6	66	3	2/0-300	3	6	
350	RED					B11CH	3			U31RT	4			13465	6	71H	4	3/0-350	3	6	
400	BLUE					B11CH	3			U32RT	4			13467	6	76	3	4/0-400	3	6	
500	BROWN					B12CHI B12CH	4			U34RT	5			13468	8	87H	4	4/0-500	3	6	2††
600	GREEN					B36CH¹	6			U36RT³	5				94H	4	250-600		8 VC7FT only	3†††	
750	BLACK					B39CH¹ 6039RT²	6 2			U39RT³	6				106H	6	500-750		9 VC7FT only	4	
1000	—					6044RT²	2			P44RT⁴	6				125H	5	750-1000			2	

* CSA Listed range 4-2 with VC6 and VC6FT

** Adjustable Indent Tool, no insert dies required

• JB12A, JB12B, HCT1239, HCT7508-12, HCT7508H

¹ HCT7508-12, HCT1239, HCT7508H only

² JB60A, JB60B only

³ Y39, Y46 only

⁴ Y46 only

† Users of VC6 and VC7 tools must strip off an extra 1/8" of insulation from end of cable to permit removal of tool over conductor sizes 250 kcmil and larger on CU connectors

†† Also use VC8 tool with aluminum nibs

††† VC8 tool crimps 500 kcmil only

†††† VC8 tool crimps 500-600 kcmil only

Compression Connectors

For flexible rope stranded or flexible stranded tinned copper locomotive conductor, welding cable and portable cord.

Tool and Die Index for Short Barrel — Types CTL, CTL-2 and CSP

CONDUCTOR TYPE					BLACKBURN® TOOLS	BURNDY® TOOLS				T&B® TOOLS		ANDERSON TOOLS					
LOCOMOTIVE		WELDING CABLE	PORTABLE CORD	STRANDED CU AWG SIZE	DIE COLOR CODE	HYD. JB12B*	CRIMPS PER END	MECH. MY29-11	CRIMPS PER END	HYD. Y35 Y39 Y46	CRIMPS PER END	HYD. TBM15	CRIMPS PER END	CU WIRE RANGE FOR LOCOMOTIVE CABLE	VC6 [†] VC6FT	VC7 [†] VC7FT	VC8 ^{††} VC8FT
SIZE	STRANDING																
6	37/24	—	8	8	RED	B71CH	1	**	1	—	—	21	2				
6	61/24	6	6	6	BLUE	B73CH	1	**	1	U5CD-1 Y34PR ³	1	24	2				
5	91/24			4	GRAY	B74CH	1	**	1	U4CD-1 Y34PR	1	29	2				
4	105/24	4	4	3	WHITE			**	2	U3CD-1 Y34PR	1						
3	125/24	3	3	2	BROWN	B75CH	1	**	2	U2CD-1 Y34PR	1	33	2	4-3	1	2	
2	150/24	2	2	1	GREEN	B05CH	1	**	2	U1CD-1 Y34PR	1	37	2	4-2	1	2	
1	225/24	1	1	1/0	PINK	B06CHI	2	**	2	U250-1 Y34PR	1	42H	3	4-1	1	2	
1/0	275/24	1/0	1/0	2/0	BLACK	B72CH	1	**	2	U26CD-1 Y34PR	1	45	2	4-1/0	1	2	
2/0	325/24	2/0	2/0	3/0	ORANGE	B08CH	1	**	2	U270-1 Y34PR	2	50	2	2-2/0	2	2	
—	—	3/0	3/0	4/0	PURPLE	B09CH	2	**	2	U280-1 Y34PR	2	54H	3				
3/0	450/24	4/0		250	YELLOW	B26CH	2	**	2	U290-1 Y34PR ³	2	62	2	1/0-3/0 [†]	2	2	
4/0	550/24		4/0	300	WHITE	B12CHI B12CH	2			U300-1 Y34PR ³	2	66	2	2/0-4/0 [†]	2		
263	650/24			300	RED	B11CH	2			U310-1 Y34PR ³	2	71H	3	3/0-263 [†]	2	3	
313	775/24			400	BLUE	B11CH	2			Y320-1 Y34PR ³	2	76	2	4/0-313V	2	3	
373	925/24			500	BROWN	B10CHI B10CH	2			U340-1 Y34PRV		87H	3	4/0-373 [†]	2	3	2 ^{†††}
444	1100/24			600	GREEN	B36CH	3			C360 Y46PR ⁴	2	94H	3	262-444		3 VC7FT Only	2 ^{†††}
535	1325/24			750	BLACK	B39CH ¹ 6039RT ²	1			C390 Y46PR ⁴	2	106H	3	373-535		4 VC7FT Only	2
646	1600/24																
777	1925/24			1000	—	6044RT ²	1			C440 Y46PR ⁴	2	125H	4	535-777			2

* JB12A, JB12B, HCT7508-12, HCT7508H, HCT1239

** Adjustable Indent Tool, no insert dies required

¹ HCT7508-12, HCT7508H, HCT1239 only

² JB60A, JB60B only

³ Y39 only

⁴ Y48B only

[†] User of VC6 and VC7 tools must strip off an extra 1/8" of insulation from end of cable to permit removal of tool over conductor sizes 250 kcmil and larger on CSP connectors

^{††} Also use VC8 tool with aluminum nibs

^{†††} VC8 tool crimps 500 kcmil only

Compression Connectors

For flexible rope stranded or flexible stranded tinned copper locomotive conductor welding cable and portable cord.

Tool and Die Index for Long Barrel — Types CTL-L, LNC and CU

CONDUCTOR TYPE					BLACKBURN® TOOLS		BURNDY® TOOLS				T&B® TOOLS		ANDERSON TOOLS				
LOCOMOTIVE		WELDING CABLE	PORTABLE CORD	STRANDED CU AWG SIZE	DIE COLOR CODE	HYD. JB12B*	CRIMPS PER END	MECH. MY29-11	CRIMPS PER END	HYD. Y35 Y39 Y46	CRIMPS PER END	HYD. TBM15	CRIMPS PER END	CU WIRE RANGE FOR LOCOMOTIVE CABLE	VC6† VC6FT	VC7† VC7FT	VC8‡ VC8FT
SIZE	STRANDING																
8	37/24	—	8	8	RED	B71CH	2	**	2	—	—	21	3				
6	61/24	6	6	6	BLUE	B73CH	2	**	2	U5CD-1 Y34PR ³	2	24	3				
6	91/24			4	GRAY	B74CH	2	**	2	U4CD-1 Y34PR	2	29	3				
4	105/24	4	4	3	WHITE			**	3	U3CD-1 Y34PR	2						
3	125/24	3	3	2	BROWN	B75CH	2	**	3	U2CD-1 Y34PR	2	33	3	4-2	2	4	
2	150/24	2	2	1	GREEN	B05CH	2	**	3	U1CD-1 Y34PR	2	37	3	4-2	2	5	
1	225/24	1	1	1/0	PINK	B06CHI	3	**	3	U250-1 Y34PR	2	42H	4	4-1	2	5	
1/0	275/24	1/0	1/0	2/0	BLACK	B72CH	2	**	3	U26CD-1 Y34PR	2	45	3	4-1/0	2	5	
2/0	325/24	2/0	2/0	3/0	ORANGE	B08CH	2	**	4	U270-1 Y34PR	2	50	3	2-2/0	3	6	
—	—	3/0	3/0	4/0	PURPLE	B09CH	3	**	4	U280-1 Y34PR	3	54H	5				
3/0	450/24	4/0		250	YELLOW	B26CH	3	**	4	U290-1 Y34PR ³	3	62	3	1/0-3/0†	3	6	
4/0	550/24		4/0	300	WHITE	B12CHI B12CH	3			U300-1 Y34PR ³	3	66	3	2/0-4/0†	3	6	
263	650/24			350	RED	B11CH	3			U310-1 Y34PR ³	3	71H	4	3/0-263†	3	6	
313	775/24			400	BLUE	B11CH	2			Y320-1 Y34PR ³	3	76	3	4/0-313†	3	6	
373	925/24			500	BROWN	B2CHI B12CH	4			U340-1 Y34PR ³		87H	3	4/0-373†	3	6	3††
444	1100/24			600	GREEN	B36CH	6			C360 Y46PR ⁴	2	94H	4	262-444		8 VC7FT Only	3††
535	1325/24			750	BLACK	B39CH ¹ 6039RT ²	2			C390 Y48PR ⁴	2	106H	6	373-535		9 VC7FT Only	4
646 777	1600/24 1925/24			1000	—	6044RT ²	2			C440 Y46PR ⁴	2	125H	5	535-777			4
1111	2750/24			1500	—	6030AH ²	2			C460 Y46PR ⁴	2	—	—	1111	—	—	4

* JB12A, JB12B, HCT7508-12, HCT7508H, HCT1239

** Adjustable Indent Tool. No insert dies required

¹ HCT7508-12, HCT7508H, HCT1239 only

² JB60A, JB60B only

³ Y39 only

⁴ Y48B only

† User of VC6 and VC7 tools must strip off an extra 1/8" of insulation from end of cable to permit removal of tool over conductor sizes 250 kcmil and larger on CSP connectors

†† Also use VC8 tool with aluminum nibs

††† VC8 tool crimps 500 kcmil only

Compression Connectors

Tool and Die Index for One- and Two-Hole Lugs, Splices — Types ATL and ASP

AL OR CU STRAND WIRE SIZE	DIE COLOR CODE	BLACKBURN® TOOLS						BURNDY® TOOLS				T&B® TOOLS					ANDERSON TOOLS		
		MECH. OD58	CRIMPS PER END	MECH. NRG 2506	CRIMPS PER END	HYD. JB12B+	CRIMPS PER END	MECH. MY29-3	CRIMPS PER END	HYD. Y35, Y39	CRIMPS PER END	MECH. TBM5S	CRIMPS PER END	MECH. TBM8S	CRIMPS PER END	HYD. TBM15	CRIMPS PER END	AL OR CU WIRE RANGE	VC6 [†] VC6FT VC8C (CRIMPS PER END)
8	BLUE	¼	2	**	1	B73CH	1	**	1	U8CABT	1	13454	2	13461	2	24	2		
6	GRAY	⅜	2	**	1	B74CH	1	**	1	U6CABT	2	13454	2	13461	2	29	2		
4	GREEN	P	3	**	2	B05CH	1	**	2	U4CABT	2	13455	2	13462	2	37	2		
2	PINK	½	4	**	2	B06CHI	2	**	2	U2CABT	2	13455	3	13462	3	42H	3	6-2	2
1	GOLD	½-1	3	**	2	B06CHI	2	**	2	U1CABT	2	13455	3	13464	3	45	2	4-1	2
1/0	TAN	⅝	4	**	2	B06CH	2	**	2	U25ART	2	13457	3	13464	3	50	2	6-1/0	2
2/0	OLIVE	⅞-1	4	**	2	B09CH	2	**	2	U26ART	2	13457	3	13464	3	54H	3	4-2/0	2
3/0	RUBY	688	5	**	2	B26CH	2	**	2	U27ART	2	13457	3	13464	3	60	2	4-3/0	2
4/0	WHITE	781	5	**	2	B10CHI	2	**	2	U28ART	2	13457	3	13465	4	66	3	2-4/0	2
250	RED	781	5	**		B11CH	3	**	2	U29ART	2	13473	4	13466	5	71H	4	1/0-250 [†]	2
300	BLUE	840				B11CH	3			U30ART	2					76	2	1/0-300 [†]	
350	BROWN					B12CH	4			U31ART	2			13468	7	87H	4	2/0-350 [†]	2
400	GREEN					B36CH	6			U32ART	4					94	2	3/0-400 [†]	2
500	PINK					B76CH	4			U34ART	4					99H	4	4/0-500 [†]	2
600	BLACK					6039RT ¹	2			U36ART	4					106	2	350-600 AL 350-600 CU	3 ^{††}
750	—					6024AH ¹	1			U39RT2 ²	4					125H	5	500-750 AL 600 CU	2 ^{†††}
1000	—					6030AH ¹	2			P44ART ²	3					150H	5	750-1000 AL	2 ^{†††}

• JB12A, JB12B, HCT7508-12, HCT1239

** Adjustable Indent Tool, no insert dies required

¹ JB60A, JB60B only

² Y46 only

³ Y39 only

[†] Users of VC6 and VC7 tools must strip off an extra 1/8" of insulation from end of cable to permit removal of tool over conductor sizes 250 kcmil and larger on CU connectors

^{††} VC6FT tool only

^{†††} With AL nibs for VC8C

Aluminum Lugs

General-purpose lugs for aluminum and copper terminations.

Aluminum One-Hole NEMA Lugs

- Dual-rated for use with aluminum and copper conductors
- Made from aluminum for high strength and high conductivity
- Prefilled with oxide inhibitor to prevent oxidation and keep out moisture
- All lugs marked with conductor sizes and die references for easy identification
- Meets or exceeds ANSI C119.4 specifications



AL 500-48

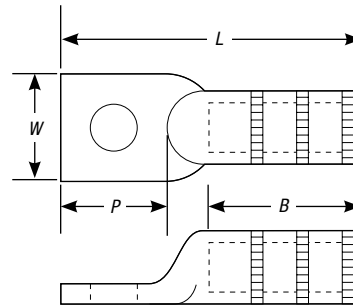

CAT. NO.	CONDUCTOR RANGE				BOLT SIZE	INSTALLING DIES	B	L	P	W
	CONCENTRIC	COMPRESSED	COMPACT	ACSR						
AL 6-14	#6	—	—	—	¼	TP, 29, 161, ⅝	¾	2½	⅞	⅞
AL 4-516	#4	—	—	—	⅝	TB, 37, 375, 162	1⅝	2¼	3½	⅝
AL 4-14		—	—	—	¼	TB, 37, 375, 162	1⅝	2¼	3½	⅝
AL 2-14	#2	—	—	—	¼	TQ, 45, 348, 163, ½, 6A	5⁹⁄₆₄	2⅝	1½	¾
AL 2-38		—	—	—	¾	TQ, 45, 348, 163, ½, 6A	5⁹⁄₆₄	2⅝	1½	¾
AL 1-38	#1	—	—	—	¾	TQ, 45, 348, 163, ½, 6A	5⁹⁄₆₄	2⅝	1½	¾
AL 1/0-38	1/0	—	—	—	¾	TU, 52, BG, 243, ⅝	1⅝	3⅝	1½	⅞
AL 1/0-48		—	—	—	½	TU, 52, BG, 243, ⅝	1⅝	3⅝	1½	⅞
AL 2/0-38	2/0	—	—	—	¾	TW-TY, 58, 297, ⅝-1	1⅝	3⅝	1½	1⅝
AL 2/0-48		—	—	—	½	TW-TY, 58, 297, ⅝-1	1⅝	3⅝	1½	1⅝
AL 3/0-38	3/0	—	—	—	¾	737, 467	1⅝	3⅝	1½	1⅝
AL 3/0-48		—	—	—	½	737, 467	1⅝	3⅝	1½	1⅝
AL 4/0-38	4/0	—	—	—	¾	TX, 71H, 298, 840, 11A	1⅝	3⅝	1½	1⅝
AL 4/0-48		—	—	—	½	TX, 71H, 298, 840, 11A	1⅝	3⅝	1½	1⅝
AL 250-48	250, 4/0	—	—	4/0	½	TX, 76, 249, 840, 11A	1⅝	3⅝	1½	1⅝
AL 300-48	300, 266.8	—	350	266.8 (18/1)	½	TH, 87H, 251, 470, 1, 12A	2⅝	4	1½	1⅝
AL 350-48	350, 336.4	—	400	266.8 (26/7), 336.4 (18/1)	½	96, 299, 655, 1⅝-1, 13A	2⅝	4¼	1½	1½
AL 400-48	400, 397.5	—	—	336.4 (26/7), 397.5 (18/1)	½	96, 299, 655, 1⅝-1, 13A	2½	4⅞	1¼	1⅝
AL 400-58		—	—	336.4 (26/7), 397.5 (18/1)	⅝	96, 299, 655, 1⅝-1, 13A	2½	4⅞	1¼	1⅝
AL 500-48	500, 477	—	600	379.5 (26/7), 477 (18/1)	½	106A, 300, 317, 1⅝, 14A	3	5⅞	1½	1¼
AL 500-58		—	600	379.5 (26/7), 477 (18/1)	⅝	106A, 300, 317, 1⅝, 14A	3	5⅞	1½	1¼
AL 600-48	600, 550	—	—	477 (26/7), 556.5 (18/1)	½	1⅝, 115H, 786, 936, 473	3	5⅝	1⅞	1⅝
AL 600-58		—	—	477 (26/7), 556.5 (18/1)	⅝	1⅝, 115H, 786, 936, 473	3	5⅝	1⅞	1⅝
AL 750-48	750, 700	—	—	636 (26/7)	½	140H, 301, 342, 1½	3⅝	6⅞	1⅞	1¼
AL 750-58		—	—	636 (26/7)	⅝	140H, 301, 342, 1½	3⅝	6⅞	1⅞	1¼
AL 800-48	800	—	—	—	½	1½, 474, 140H	3⅝	6⅞	2⅝	1¼
AL 800-58		—	—	—	⅝	1½, 474, 140H	3⅝	6⅞	2⅝	1⅝
AL 1000-48	1000, 954	—	—	795 (26/7), 954 (45/7)	½	161, 292, 302, 319, 1¼	4⅞	7⅞	1⅞	2⅞
AL 1000-58		—	—	795 (26/7), 954 (45/7)	⅝	161, 292, 302, 319, 1¼	4⅞	7⅞	1⅞	2⅞

Note: For tin plating, add "TN" suffix to the catalog number. All tin-plated lugs are UL Listed through 1000 kcmil.
For straight lugs with tapered ends used in high-voltage applications, please consult your Thomas & Betts representative.

Aluminum Lugs

General-purpose lugs for aluminum and copper terminations.

Aluminum Two-Hole NEMA Lugs

- Dual-rated for use with aluminum and copper conductors
- Made from aluminum for high strength and high conductivity
- Prefilled with oxide inhibitor to prevent oxidation and keep out moisture
- All lugs marked with conductor sizes and die references for easy identification
- Meets or exceeds ANSI C119.4 specifications

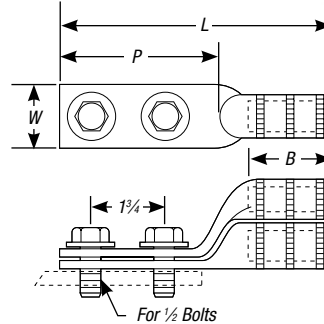
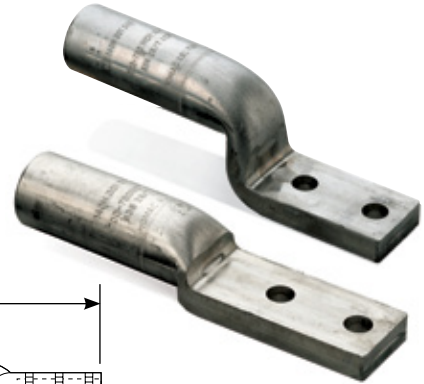

STRAIGHT LUG CAT. NO.	STACKING LUG CAT. NO.	CONDUCTOR RANGE				BOLT SIZE	INSTALLING DIES	B	L	P	W
		CONCENTRIC	COMPRESSED	COMPACT	ACSR						
SA 6 N	ASL 6 N	#6	#6	#6, #4	#6	4	TU, 52, BG, 243, 3/8, CSA 22	1 1/32	5 1/4	3 3/16	7/8
SA 4 N	ASL 4 N	#4	#4	—	#4	2	TU, 52, BG, 243, 3/8, CSA 22	1 1/32	5 1/4	3 3/16	7/8
SA 2 N	ASL 2 N	#2-#1	#1	#1	#2	1/0	TU, 52, BG, 243, 3/8, CSA 22	1 1/2	5 3/16	3 1/4	1
AL 1/0 N	ASL 1/0 N	1/0	—	2/0	1/0	2/0	TU, 52, BG, 243, 3/8	1 1/2	5 1/4	3 3/16	7/8
AL 2/0 N	ASL 2/0 N	2/0	—	—	—	—	TW-TY, 58, 297, 3/8-1	1 1/2	5 1/4	3 3/16	1 1/16
AL 3/0 N	ASL 3/0 N	3/0	—	—	—	—	TV, 66, 167, 467, 10A	1 1/16	5 1/2	3 1/4	1 1/16
AL 4/0 N	ASL 4/0 N	4/0	—	—	—	—	TX, 71H, 298, 840, 11A	1 1/16	6	3 1/2	1 1/64
AL 250 N	ASL 250 N	250, 4/0	—	250-300	4/0 (6/1)	—	TX, 76, 249, 840, 11A	1 1/16	6	3 1/2	1 1/64
AL 300 N	ASL 300 N	300, 266.8	—	350	266.8 (18/1)	—	TH, 87H, 251, 470, 1, 12A	2 3/16	6 9/16	3 3/16	1 1/32
AL 350 N	ASL 350 N	350, 336.4	—	—	266.8 (26/7), 336.4 (18/1)	—	96, 299, 655, 1 1/8-1, 705, 13A	2 3/16	6 9/16	3 1/16	1 3/4
AL 336 NSC	—	397.5-400	—	—	336.4 (26/7), 397.5 (18/1)	—	114, 99H, 317, 20AH	4 3/16	9	3 1/16	1 3/32
AL 400 N	ASL 400 N	400, 397.5	—	—	336.4 (26/7), 397.5 (18/1)	—	96, 472, 655, 1 1/8-1, 1 1/8-2, 705, 316 13A	2 1/16	7 7/16	3 3/16	1 3/4
AL 500 N	ASL 500 N	500, 477	—	500-600	397.5 (26/7), 477 (18/1)	—	106A, 300, 317, 1 1/8, 14A, 15A	2 5/16	8 3/4	3 3/16	1 3/4
AL 500 N 608	—	500, 477	—	600	397.5 (26/7), 477 (18/1)	—	608	3 1/8	8 3/4	3 3/16	1 3/4
AL 600 N	ASL 600 N	600, 550	—	—	477 (26/7), 556.5 (18/1)	—	1 1/8, 115H, 786, 936, 473	2 5/16	7 3/4	3 3/8	1 3/4*
AL 700 N 608	—	700, 600	—	700-795	—	—	125H, 608	3 3/16	7 7/8	3 1/2	1 3/4
AL 750 N	ASL 750 N	750, 700	—	—	636 (26/7)	—	140H, 301, 342, 1 1/2	3 5/16	8 1/4	3 3/4	1 3/4*
AL 750 N 608	ASL 750 N 608	750, 700	—	—	636 (26/7)	—	125H, 608	3 3/8	8 1/4	3 3/8	1 3/4
AL 800 N	ASL 800 N	800, 795	—	—	663 (30/19), 715.5 (54/7)	—	140H, 474, 342, 724, 1 1/2	3 11/32	8 3/16	3 3/8	1 3/4*
AL 800 N 608	—	800, 700	—	—	636 (30/19), 715.5 (54/7)	—	608	3 3/8	8 1/4	3 3/8	1 3/4
AL 1000 N	ASL 1000 N	1000, 954	—	—	795 (26/7, 30/19), 954 (45/7)	—	161, 292, 302, 319, 1 3/4	4 1/16	9 1/16	3 3/8	2 1/16
AL 1000 SSN	ASL 1000 SSN	1000	—	—	—	—	161, 292, 302, 319, 1 3/4	4 1/16	9 7/8	1 7/8	2 1/16
AL 1000 NMSNP	—	1000	—	—	—	—	161, 292, 302, 319, 1 3/4	4 1/16	9 1/2	3 3/8	1 3/4
AL 954 NMSNP	—	—	—	—	954 (54/7)	—	161, 292, 302, 319, 1 3/4	4 1/16	9 3/8	3 3/8	1 3/4
AL 1250 N	ASL 1250 N	1200-1300	—	—	1113 (45/7), 1192.5 (45/7)	—	161, 727, 352	4 1/16	9 1/16	3 3/8	2 1/32
AL 1750 N	ASL 1750 N	1750	—	—	—	—	214, 735, 225	5 1/2	10 7/8	3 3/8	3 3/32
AL 2000 N	ASL 2000 N	2000	—	—	—	—	479	6 1/16	11 1/16	3 3/8	3 3/32

* Trimmed to 1/4" maximum to fit side by side on NEMA spades.

Note: For tin plating, add "TN" suffix to the catalog number. All tin-plated lugs are UL Listed through 2000 kcmil.
For straight lugs with tapered ends used in high-voltage applications, please consult your Thomas & Betts representative.

Aluminum Lugs

General-purpose lugs for aluminum and copper terminations.

Aluminum Tin-Plated Two-Hole NEMA Lugs

- Dual-rated for use with aluminum and copper conductors
- Aluminum provides high strength and high conductivity
- Prefilled with oxide inhibitor to prevent oxidation and keep out moisture
- All lugs marked with conductor sizes and die references for easy identification
- All lugs meet or exceed ANSI C119.4 specifications

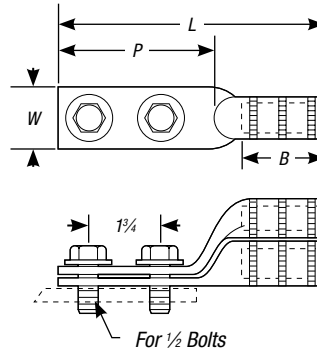

STRAIGHT LUG CAT. NO.	STACKING LUG CAT. NO.	CONDUCTOR RANGE					INSTALLING DIES	B	L	P	W
		CONCENTRIC	COMPRESSED	COMPACT	ACSR	SOLID					
SA 6 NTN	ASL 6 NTN	#6	#6	#6, #4	#6	#4	TU, 52, BG, 243, 3/8, CSA 22	1 1/2	5 1/4	3 3/16	7/8
SA 4 NTN	ASL 4 NTN	#4	#4	—	#4	#2	TU, 52, BG, 243, 3/8, CSA 22	1 1/2	5 1/4	3 3/16	7/8
SA 2 NTN	SAL 2 NTN	#2-#1	#1	#1	#2	1/0	TU, 52, BG, 243, 3/8, CSA 22	1 1/2	5 1/4	3 3/16	1
AL 1/0 NTN*	ASL 1/0 NTN*	1/0	—	2/0	1/0	2/0	TU, 52, BG, 243, 3/8	1 1/2	5 1/4	3 3/16	7/8
AL 2/0 NTN*	ASL 2/0 NTN*	2/0	—	—	—	—	TW-TY, 58, 297, 5/8-1	1 1/2	5 1/4	3 3/16	1 1/16
AL 3/0 NTN*	ASL 3/0 NTN*	3/0	—	—	—	—	TV, 66, 167, 467, 10A	1 1/2	5 1/2	3 1/4	1 1/16
AL 4/0 NTN*	ASL 4/0 NTN*	4/0	—	—	—	—	TX, 71H, 298, 840, 11A	1 1/2	6	3 1/2	1 1/16
AL 250 NTN*	ASL 250 NTN*	250, 4/0	—	250-300	4/0 (6/1)	—	TX, 76, 249, 840, 11A	1 1/2	6	3 1/2	1 1/16
AL 300 NTN*	ASL 300 NTN*	300, 266.8	—	350	266.8 (18/1)	—	TH, 87H, 251, 470, 1, 12A	2 3/16	6 3/16	3 3/16	1 1/32
AL 350 NTN*	ASL 350 NTN*	350, 336.4	—	—	266.8 (26/7), 336.4 (18/1)	—	96, 299, 655, 1 1/8-1, 705, 13A	2 3/16	6 3/16	3 1/16	1 3/4
AL 336 NSCTN	—	397.5-400	—	—	336.4 (26/7), 397.5 (18/1)	—	1 1/4, 99H, 317, 20AH	4 3/16	9	3 1/16	2 1/32
AL 400 NTN*	ASL 400 NTN*	400, 397.5	—	—	336.4 (26/7), 397.5 (18/1)	—	96, 472, 655, 1 1/8-1, 1 1/8-2, 705, 316, 13A	2 1/16	7 7/16	3 3/16	1 3/4
AL 500 NTN*	ASL 500 NTN*	500, 477	—	500-600	397.5 (26/7), 477 (18/1)	—	106A, 300, 317, 1 1/16, 14A, 15A	2 5/16	8 1/4	3 3/16	1 3/4
AL 500 N 608 TN	—	500, 477	—	600	397.5 (26/7), 477 (18/1)	—	608	3 3/8	8 1/4	3 3/16	1 3/4
AL 600 NTN*	ASL 600 NTN*	600, 550	—	—	477 (26/7), 556.5 (18/1)	—	1 1/16, 115H, 786, 936, 473	2 15/16	7 3/4	3 3/8	1 3/4
AL 700 N 608 TN	—	700, 600	—	700-795	—	—	125H, 608	3 3/16	7 3/8	3 1/2	1 3/4
AL 750 NTN*	ASL 750 NTN*	750, 700	—	—	636 (26/7)	—	140H, 301, 342, 1 1/2	3 15/16	8 1/4	3 3/4	1 3/4
AL 750 N 608*	ASL 750 N 608*	750, 700	—	—	636 (26/7)	—	125H, 608	3 3/8	8 1/4	3 3/8	1 3/4
AL 800 NTN*	ASL 800 NTN*	800, 795	—	—	663 (30/19), 715.5 (54/7)	—	140H, 474, 342, 724, 1 1/2	3 11/32	8 5/16	3 3/8	1 3/4
AL 800 N 608 TN	—	800, 700	—	—	636 (30/19), 715.5 (54/7)	—	608	3 3/8	8 1/4	3 3/8	1 3/4
AL 954 NMS	—	—	—	—	954 (54/7)	—	161, 292, 302, 319, 1 3/4	4 11/16	9 3/8	3 3/8	1 3/4
AL 1000 NTN*	ASL 1000 NTN*	1000, 954	—	—	795 (26/7, 30/19), 954 (45/7)	—	161, 292, 302, 319, 1 3/4	4 3/16	8 3/8	3 3/8	2 1/16
AL 1000 SSNTN	ASL 1000 SSNTN	1000	—	—	—	—	161, 292, 302, 319, 1 3/4	4 3/16	9 3/8	1 3/8	2 1/16
AL 1000 NMS	—	1000	—	—	—	—	161, 292, 302, 319, 1 3/4	4 11/16	9 1/2	3 3/8	1 3/4
AL 1250 NTN	ASL 1250 NTN	1200-1300	—	—	1113 (45/7), 1192.5 (45/7)	—	161, 727, 352	4 11/16	9 11/16	3 3/8	2 21/32
AL 1750 NTN	ASL 1750 NTN	1750	—	—	—	—	214, 735, 225	5 1/2	10 3/8	3 3/8	3 13/32
AL 2000 NTN	ASL 2000 NTN	2000	—	—	—	—	479	6 1/16	11 11/16	3 3/8	3 13/32

* UL Listed.

Note: For two-hole lugs without tin plating, see previous page.

For straight lugs with tapered ends used in high-voltage applications, please consult your Thomas & Betts representative.

Aluminum Lugs

General-purpose lugs for aluminum and copper terminations.

Aluminum Four-Hole NEMA Lugs

- Dual-rated for use with aluminum and copper conductors
- Made from aluminum for high strength and high conductivity
- Prefilled with oxide inhibitor to prevent oxidation and keep out moisture
- All lugs marked with conductor sizes and die references for easy identification

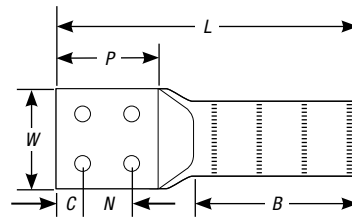

CAT. NO.	CONCENTRIC	ACSR	INSTALLING DIES	B	N	C	W	P	L
AL 1000-4N	1000	—	161, 302, 292, 319, 1¼	4 ⁵ / ₁₆	1¼	5 ⁵ / ₁₆	3	4	10
AL 14136 X	1033.5–1300	900–1113	161, 727, 352	7 ¹ / ₁₆			3	4¼	13¾
AL 1033-4N	—	1033.5 (54/7)	34AH	6 ⁵ / ₁₆			3 ³ / ₁₆	3 ¹ / ₁₆	12¾
AL 1250-4N	1250	—	161, 727, 352	4 ⁵ / ₁₆			3	3 ³ / ₁₆	10
AL 1272-4N	1272	—	161, 727, 352, 579	6 ⁵ / ₁₆			3	3 ⁵ / ₁₆	11¼
AL 1590-4N	1590	1272 (45/7)	728, 38AH, 189	8 ³ / ₁₆		3	3 ⁵ / ₁₆	13½	
AL 1750-4N	1750	—	214, 735, 40AH, 225	6 ¹ / ₁₆		3½	3¾	12½	
AL 2000-4N	1700–2000	1510.5–1590	214, 735, 40AH, 225	6 ¹ / ₁₆		7 ⁵ / ₁₆	3½	3¾	12½
AL 2300-4N	2250–2300	2167 (72/7)	44AH	11¾		4	4½	18½	
AL 2500-4N	2500	2156–2167	214	9 ⁵ / ₁₆		1 ⁵ / ₁₆	3½	4	15¾

Note: For tin-plating option, add “-TN” suffix to the catalog number.

Aluminum Lugs

Designed for general applications and for installation on Homac® 125 Series insulated buses.

Aluminum One-Hole NEMA Lugs — Common Die Series

- Entire conductor range installed by four dies to reduce your die inventory
- Stacking lugs double terminal capacity of transformer spades and buses to save money
- Dual-rated for use with aluminum and copper conductors
- Made from aluminum for high strength and high conductivity
- Prefilled with oxide inhibitor to prevent oxidation and keep out moisture
- All lugs marked with conductor sizes and die references for easy identification
- Meets or exceeds ANSI C119.4 specifications

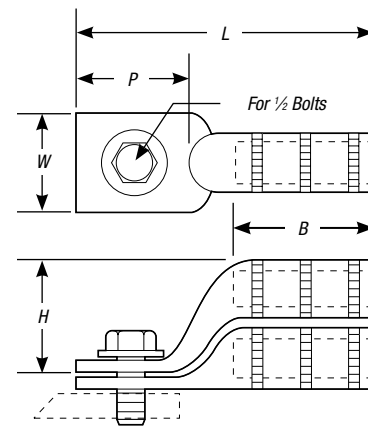

STRAIGHT LUG CAT. NO.	STACKING LUGS CAT. NO.	CONDUCTORS — AL OR CU					INSTALLING DIES	B	H	L	P	W
		CONCENTRIC	COMPRESSED	COMPACT	SOLID	ACSR						
SA 12-48	—	#12	—	—	#12	—	TU, 52, BG, 243, 5/8, CSA 22	23/32	—	2 5/16	1 1/4	7/8
SA 10-48	—	#12	—	—	#12	—						
SA 8-48	—	#8	—	—	#6	—						
SA 6-48	—	#6	#6	#4	#4	#6						
SA 4-48	—	#4	#4	#4	#2	#4						
SA 3-48	—	#2	#2	#1, #2	#1	—						
SA 2-48	SASL 2-48	#1, #2	#1	#1	1/0	#2						
SA 386-48	—	#1	1/0	1/0	—	—	1 5/16	1 1/2	3 3/8	1 5/16	1 1/2	
SA 1/0-48	SASL 1/0-48	1/0	1/0	2/0	—	1/0	1 1/2	—	—	—		
SA 2/0-48	SASL 2/0-48	2/0	2/0	3/0	3/0	2/0 (6/1)	1 5/8	1 3/4	3 2/64	—		
SA 3/0-48	SASL 3/0-48	3/0	4/0	4/0	—	3/0	TX, 76, 249, 840, 845, 11A, CSA 24	1 5/8	1 3/4	3 2/64	—	1 1/2
SA 4/0-48	SASL 4/0-48	4/0, 250	4/0, 250	250, 300	—	4/0		1 5/8	1 3/4	3 2/64	—	1 1/2
SA 300-48	—	300	300	350	—	266.8 (18/1)	96, 299, 655, 321, 316, 13A, 1 1/8-1, 472, CSA 28	1 1/2	—	3 3/8	—	1 1/4
SA 350-48	—	336.4-350	350	400	—	266.8 (26/7), 336.4 (18/1)		1 1/2	—	3 3/8	—	1 1/4
SA 400-48	—	336.4-400	400	500	—	336.4 (18/1), 397.5 (18/1)		1 1/2	—	3 3/8	—	1 1/4

Note: For tin-plating option, add "-TN" suffix to the catalog number.
To order a stud size not specified with a terminal lug on this page, change the last two digits from "48"
(designating a 1/2" stud) to "38" (for a 3/8" stud).

Aluminum Lugs

Designed for general applications and for installation on Homac® 125-N Series insulated buses.

Aluminum Two-Hole NEMA Lugs — Common Die Series



- Entire conductor range installed by four dies to reduce your die inventory
- Stacking lugs double terminal capacity of transformer spades and buses to save money
- Dual-rated for use with aluminum and copper conductors
- Made from aluminum for high strength and high conductivity
- Prefilled with oxide inhibitor to prevent oxidation and keep out moisture
- All lugs marked with conductor sizes and die references for easy identification
- Meets or exceeds ANSI C119.4 specifications

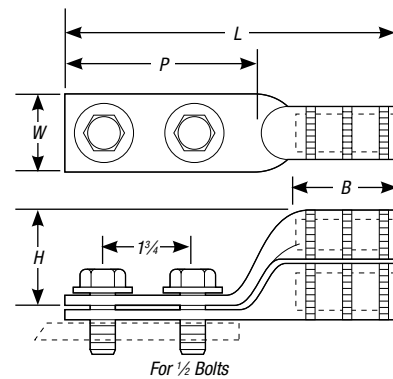

STRAIGHT LUG CAT. NO.	STACKING LUGS CAT. NO.	CONDUCTORS — AL OR CU					INSTALLING DIES	B	H	L	P	W
		CONCENTRIC	COMPRESSED	COMPACT	SOLID	ACSR						
SA 8 N	—	#8	—	—	#6	—	TU, 52, BG, 243, 3/8, CSA 22	1 ¹⁵ / ₁₆	—	5 ¹ / ₈	3 ³ / ₁₆	7 ¹ / ₈
SA 6 N	SASL 6 N	#6	#6	#4	#4	#6		1 ¹⁵ / ₁₆	1 ¹ / ₂	5 ¹ / ₈	3 ³ / ₁₆	7 ¹ / ₈
SA 4 N	—	#4	#4	#4	#2	#4		1 ¹⁵ / ₁₆	—	5 ¹ / ₈	3 ³ / ₁₆	7 ¹ / ₈
SA 3 N	—	#2	#2	#1, #2	#1	—		1 ¹⁵ / ₁₆	—	5 ¹ / ₈	3 ³ / ₁₆	7 ¹ / ₈
SA 2 N	—	#1, #2	#1	#1	1/0	#2		1 ¹ / ₂	—	5 ¹ / ₁₆	3 ¹ / ₈	1
SA 386 N	—	#1, 1/0	#1, 1/0	1/0	—	#1		1 ²⁷ / ₃₂	—	5 ¹ / ₂	3	7 ¹ / ₈
AL 1/0 N	ASL 1/0 N	1/0	1/0	2/0	2/0	1/0	TX, 76, 249, 840, 845, 11A, CSA 24	1 ¹ / ₂	1 ¹ / ₂	5 ¹ / ₄	3 ³ / ₁₆	7 ¹ / ₈
SA 2/0 N	SASL 2/0 N	2/0	2/0	3/0	3/0	2/0 (6/1)		1 ¹⁵ / ₁₆	1 ³ / ₄	6	3 ³ / ₈	1 ¹ / ₄
SA 3/0 N	SASL 3/0 N	3/0	4/0	4/0	—	3/0		1 ¹⁵ / ₁₆	1 ³ / ₄	6	3 ³ / ₁₆	1 ¹ / ₃₂
SA 4/0 N	SASL 4/0 N	4/0, 250	4/0, 250	250, 300	—	4/0	96, 299, 655, 705, 321, 316, 13A, 1 ¹ / ₆ -1, 472, CSA 28	1 ¹⁵ / ₁₆	1 ³ / ₁₆	6	3 ³ / ₁₆	1 ¹ / ₃₂
SA 300 N	—	300	300	350	—	266.8 (18/1)		2 ¹ / ₁₆	—	6 ¹ / ₄	3	1 ¹ / ₄
SA 350 N	—	336.4–350	350	400	—	266.8 (26/7), 336.4 (18/1)		2 ³ / ₁₆	—	6 ¹ / ₄	3	1 ¹ / ₄
SA 400 N	—	336.4–400	400	500	—	336.4 (18/1), 397.5 (18/1)	2 ¹ / ₁₆	—	6 ³ / ₈	3	1 ¹ / ₄	

Note: For tin-plating option, add "-TN" suffix to the catalog number.

Aluminum Lugs

Just one die installs the entire conductor range for meter pan and general applications.

Aluminum Meter Socket Lugs — 840 Common Die Series

- All installation done with one die to reduce your die inventory
- Made from aluminum for high strength and high conductivity
- Dual-rated for use with aluminum and copper conductors
- Connector bores coated with oxide inhibitor to prevent oxidation
- All lugs marked with conductor sizes and die references for easy identification
- Lugs meet or exceed ANSI C119.4 specifications

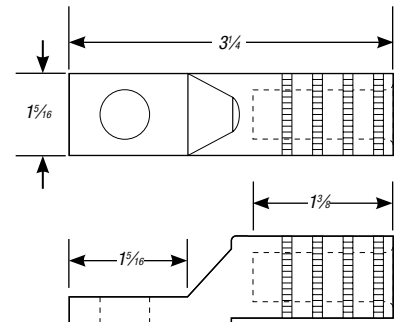

½ BOLT CAT. NO.	¾ BOLT CAT. NO.	CONDUCTORS — AL OR CU				INSTALLING DIES
		CONCENTRIC	COMPRESSED	COMPACT	SOLID	
SAKM 6-48	SAKM 6-38	#6	#6	#6	—	840, 845, TX,76,249,11A
SAKM 4-48	SAKM 4-38	#4	#4	#4	—	
SAKM 2-48	SAKM 2-38	#2	#2	#2 & #1	#1	
SAKM1-48	SAKM 1-38	#1	#1	1/0	1/0	
SAKM 1/0-48	SAKM 1/0-38	1/0	1/0	2/0	2/0	
SAKM 2/0-48	SAKM 2/0-38	2/0	2/0	3/0	3/0	
SAKM 3/0-48	SAKM 3/0-38	3/0	3/0	4/0	—	
SAKM 4/0-48	SAKM 4/0-38	4/0	4/0	250	—	
SAKM 250-48*	SAKM 250-38*	250	250	300	—	
SAKM 300-48*	SAKM 300-38*	300	300	350	—	
SAKM 350-48*	SAKM 350-38*	350	350	—	—	

* For aluminum conductors only.

Note: For tin-plating option, add "-TN" suffix to the catalog number.

Aluminum Lugs

Dual-rated, corrosion-resistant lugs available with star holes.

Aluminum Tin-Plated Meter Socket Lugs — Star Hole

- Made from aluminum for high strength and high conductivity
- Dual-rated for use with aluminum and copper conductors
- Tin plated to resist corrosion
- Prefilled with oxide inhibitor to prevent oxidation and keep out moisture



MSL 350

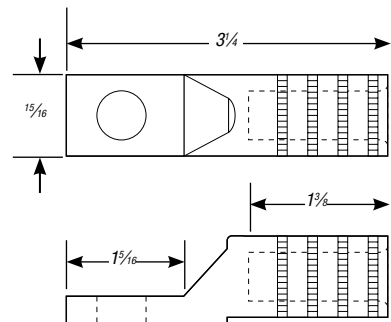

CAT. NO.	CONDUCTOR SIZE	INSTALLING DIES	W	L	P	B
MSL 4	#4 str. cpt.	840, 845, TX, 76, 249, 11A	1/16	3/4	1/16	1/8
MSL 2	#2 str. cpt. sol.					
MSL 1/0	1/0 str. cpt.					
MSL 2/0	2/0 str. cpt.					
MSL 3/0	3/0 str. cpt.					
MSL 4/0	4/0 str. cpt.					
MSL 250	250 str. cpt.					
MSL 300	300 str. cpt.					
MSL 350	350 str. cpt.					
MSL 500	500 str.					

Aluminum Lugs

Lugs designed for general-purpose substation and switchyard equipment use.

Aluminum Two-Hole NEMA Lugs — Common Die Series

- Entire conductor range installed by three common dies to reduce your die inventory
- Dual-rated for use with aluminum and copper conductors
- Made from aluminum for high strength and high conductivity
- Prefilled with oxide inhibitor to prevent oxidation and keep out moisture
- All lugs marked with conductor sizes and die references for easy identification



SAB 500-N

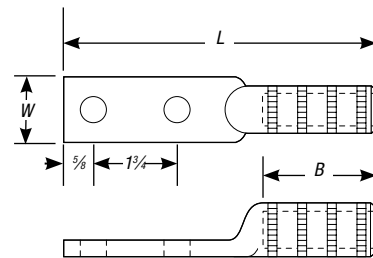

CAT. NO.	CONCENTRIC	COMPRESSED	COMPACT	ACSR	INSTALLING DIES	L	W	B
SAK 4 N	#4	—	—	—	TX, 76, 249, 840, 11A	5 ³ / ₄	1 ¹ / ₄	2
SAK 2 N	#1, #2	—	—	#2		5 ³ / ₄	1 ¹ / ₄	2
SAK 1/0 N	1/0	2/0	2/0	1/0		5 ³ / ₄	1 ¹ / ₄	2
SAK 300 N	—	—	350	—		6 ¹ / ₄	1 ¹ / ₄	2 ¹ / ₁₆
SAK 350 N	350	—	—	—		6 ¹ / ₄	1 ¹ / ₄	2 ¹ / ₁₆
SAB 3/0 N	3/0	—	—	3/0	96, 299, 655, 1 ¹ / ₈ -1, 13A	6 ³ / ₈	1 ¹ / ₂	2 ¹ / ₄
SAB 4/0 N	4/0, 250	—	—	4/0		6 ³ / ₈	1 ¹ / ₂	2 ¹ / ₄
SAB 250 N	266.8-300	—	—	266.8 (18/1)		6 ³ / ₈	1 ¹ / ₂	2 ¹ / ₄
SAB 500 N	477-500	—	600	397.5 (26/7), 30/7, 477 (18/1)		6 ³ / ₈	1 ¹ / ₄	2 ¹ / ₄
SAM 400 N	397.5-400	—	500	336.4 (30/7), 397.5 (18/1)		8 ²⁹ / ₆₄	1 ³ / ₄	3 ¹³ / ₁₆
SAM 556 N	500-556	—	—	477 (26/7), 556.5 (18/1)	106, 300, 317, 1 ¹ / ₁₆ , 14A, 15A	8 ³ / ₈	1 ³ / ₄	3 ²⁷ / ₃₂
SAM 600 N	600	—	—	—		8 ³ / ₈	1 ³ / ₄	3 ²⁷ / ₃₂

Aluminum Lugs

Durable four-hole lugs for general-purpose substation and switchyard equipment use.

Aluminum Four-Hole NEMA Lugs — Common Die Series

- Entire conductor range installed by three common dies to reduce your die inventory
- Dual-rated for use with aluminum and copper conductors
- Made from aluminum for high strength and high conductivity
- Prefilled with oxide inhibitor to prevent oxidation and keep out moisture
- All lugs marked with conductor sizes and die references for easy identification



SAM 500-4N

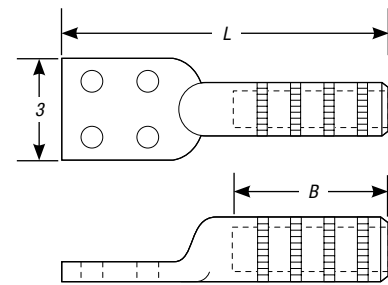

CAT. NO.	CONCENTRIC	COMPACT	ACSR	L	B	INSTALLING DIES	
SAM 3/0-4N*	3/0	—	—	8 ¹ / ₈	3 ³ / ₁₆	1 ¹ / ₁₆ , 300, 14A, 106, 317	
SAM 4/0-4N*	4/0	—	4/0	8 ¹ / ₈	3 ³ / ₁₆		
SAM 250-4N*	250	—	—	8 ¹ / ₈	3 ³ / ₁₆		
SAM 300-4N*	300	—	—	7 ⁷ / ₈	3 ²¹ / ₆₄		
SAM 350-4N*	336.4–350	—	266.8 (26/7), 336.4 (18/1)	7 ⁷ / ₈	3 ²¹ / ₆₄		
SAM 400-4N*	397.5–400	—	336.4 (30/7), 397.5 (18/1)	7 ⁷ / ₈	3 ²¹ / ₆₄		
SAM 500-4N*	500	—	—	8 ¹ / ₄	3 ³ / ₁₆		
SAM 600-4N*	556.5–600	—	—	8 ¹ / ₄	3 ³ / ₁₆		
SAL 500-4N*	500	—	477 (18/1)	8 ¹ / ₄	3 ³ / ₈		140H, 301, 342, 1 ¹ / ₂
SAL 600-4N	600	—	477 (24/7, 30/7)	7 ⁷ / ₈	3 ³ / ₈		
SAL 650-4N	600, 636, 650	—	556.5 (24/7, 26/7)	7 ⁷ / ₈	3 ³ / ₈		
SAL 750-4N	700–750	—	636 (26/7)	9	4 ¹ / ₃₂		
SAL 800-4N	700–800	954	636 (26/7)	8 ³ / ₄	4 ¹ / ₃₂		
SAL 1000-4N	1000	1000	795 (30/19), 874 (54/7)	8 ³ / ₄	4 ¹ / ₃₂		
SAL 1033-4N	1033	—	900 (54/7), 954 (45/7)	9	4 ¹ / ₃₂		

* Designates two-piece welded design.

Aluminum Lugs

If you need rain protection, these lugs have you covered.

Aluminum Shrouded One-Hole Lugs — Common Die Series

- Rainshield protection for insulated cables prevents rainwater from entering cable
- Entire conductor range installed with three common dies to reduce your die inventory
- Made from aluminum for high strength and high conductivity
- Dual-rated for use with aluminum and copper conductors
- Connector bores coated with oxide inhibitor to prevent oxidation
- Marked with conductor sizes and die references for easy identification
- Meets or exceeds ANSI C119.4 specifications

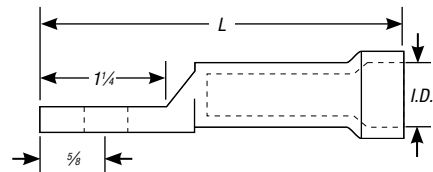
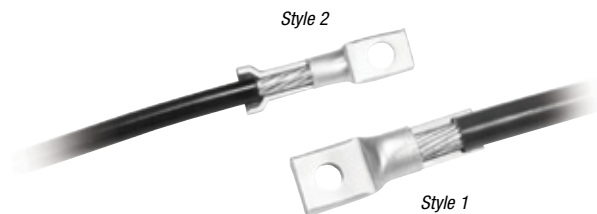

CAT. NO.	CONDUCTOR SIZES		SHROUD I.D.	COMPRESSION DIE SIZE	L	STYLE
	CONCENTRIC	COMPACT				
3/8 Compression Die Series						
RSK 6-48	#6	—	.400	3/8, 8A, 243, TU, 52, BG	3/8	2
RSK 4-48	#4	#4	.450			
RSK 2-48	#2 & #1	#1	.635		3/8	1
RSK 1/0-48	1/0	2/0	.640			
840 Compression Die Series						
RSK 1/0-48	1/0	2/0	.640	840, 11A, 249, 76, TX	3/4	2
RSK 2/0-48	2/0	3/0	.750			
RSK 3/0-48	3/0	4/0	.750			
RSK 4/0-48	4/0	4/0	.750			
RSK 250-48	4/0-250	350	.812		4/16	1
RSK 350-48	350	—	.927			
1 1/8 Compression Die Series						
RSB 300-48	300	300	.927	1 1/8-1, 12A, 96, 299, 655	4/2	2
RSB 350-48	350	300	.927			

Note: For tin-plating option, add "-TN" suffix to the catalog number.

To order a terminal lug for a 3/8" stud, change a catalog number's "-48" suffix (designating a 1/2" stud) to a "-38" suffix.

To order with hardware as kits, add "-TMH" suffix to the catalog number.

Aluminum Lugs

For application in meter pans and in other metal-enclosed gear to enable easier wiring where clearances are minimal.



Aluminum Tin-Plated One-Hole Lugs

- Made from aluminum for high strength and high conductivity
- Tin plated for resistance against corrosion
- Dual-rated for use with aluminum and copper conductors
- Connector bores coated with oxide inhibitor to prevent oxidation
- All lugs marked with conductor sizes and die references for easy identification
- Meets or exceeds ANSI C119.4 specifications

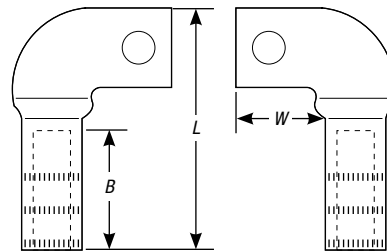

LEFT-HAND LUG CAT. NO.	RIGHT-HAND LUG CAT. NO.	CONDUCTOR SIZE			INSTALLING DIES	B	L	W
		CONCENTRIC	COMPRESSED	COMPACT				
AL 1/0-48 LTN	AL 1/0-48 RTN	1/0	1/0	2/0	¾, BG, TU	1⅜	2⅛	1⅜
AL 2/0-48 LTN	AL 2/0-48 RTN	2/0	2/0	—	1⅜, 297, TW-TY	1⅜	2⅛	1⅜
AL 3/0-48 LTN	AL 3/0-48 RTN	3/0	3/0	—	737, 467	1⅜	3¼	1⅜
AL 4/0-48 LTN	AL 4/0-48 RTN	4/0	4/0	—	840, 298, TX	1½	4	1¾
AL 250-48 LTN	AL 250-48 RTN	250	250	300	840, 324, TX	1⅝	4⅝	1¾
AL 300-48 LTN	AL 300-48 RTN	300	300	350	1, 470, TH	1⅝	4⅝	1½
AL 350-48 LTN	AL 350-48 RTN	350	350	350	1⅝-1, 299, 96	1⅝	4⅝	1½
AL 400-48 LTN	AL 400-48 RTN	400	400	400	1⅝, 472, 96	2½	5¼	1½
AL 500-48 LTN	AL 500-48 RTN	500	500	500	1⅝, 300, 106A	2½	5¼	1½
AL 750-48 LTN	AL 750-48 RTN	700-750	800	800	1⅝, 301, 140H	3¼	6⅝	3½

Note: For NEMA-drilled lugs, substitute a "-NLTN" suffix for a "-48 xTN" suffix to the catalog number.
Thus AL 350-48 RTN becomes AL 350-NLTN. NEMA drilling is 2/16" holes on 1/4" centers.

Aluminum Lugs

Save yourself a die job with these multi-range lugs.

Aluminum Multi-Range Die-Less Lugs

- Made from aluminum for high strength and high conductivity
- Tin plated for resistance against corrosion
- Dual-rated for use with aluminum and copper conductors
- Connector bores coated with oxide inhibitor to prevent oxidation
- All lugs marked with conductor sizes for easy identification



AL 4/0 NTN

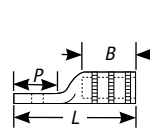

Fig. 1

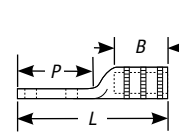

Fig. 2

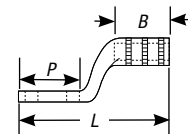

Fig. 3

CAT. NO.	CONDUCTOR RANGE ALUM. OR COPPER	TOOL	FIGURE	BOLT SIZE	B	L	P
AL 1/0-48 TN	#6 str.-1/0 str.	VC 5/VC 6	1	1/2	1 3/8	3 3/8	1 1/8
AL 1/0 NTN	#6 str.-1/0 str.		2		1 3/8	5 1/4	3/4
ASL 1/0 NTN	#6 str.-1/0 str.		3		1 3/8	5 1/4	3
AL 4/0-48 TN	#2 str.-4/0 str.		1		1 7/8	3 3/8	1 3/8
AL 4/0 NTN	#2 str.-4/0 str.		2		2	6	3 3/8
ASL 4/0 NTN	#2 str.-4/0 str.		3		2	6	3
AL 300-48 TN	1/0 str.-300	VC 6	1	1/2	2 1/4	4	1 1/8
AL 300 NTN	1/0 str.-300		2		2 1/4	6 3/8	3 3/8
AASL 300 NTN	1/0 str.-300		3		2 1/4	6 3/8	3
SAB 500-48 TN	4/0 str.-500	VC 8	1	1/2	2 1/2	4 3/8	1 1/2
SAB 500 NTN	4/0 str.-500		2		2 1/4	6 3/8	3 3/8
AASL 500 NTN	4/0 str.-500		3		2 1/2	6 3/8	2 3/8
AL 750 N 608 TN	4/0 str.-750	VC 8	2		3 3/4	8 1/4	3 3/8

Note: To order a stud size not specified here with a terminal lug, substitute a "-58" suffix (designating a 5/8" stud) for a "-48" suffix (designating a 1/2" stud) to the catalog number.

The pins you need for hassle-free terminations.

Aluminum Pin Terminals

- Made from pure electrolytic aluminum and soft-drawn, tinned, solid copper wire for the high strength and conductivity of aluminum and the flexibility of copper
- Offer bi-metallic transitions from all aluminum, ACSR and aluminum-alloy conductors to copper clamp-type equipment bushings to eliminate compatibility problems with connections

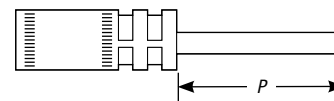

CAT. NO.	CONDUCTOR SIZE	DECIMAL RANGE		TOOL	CU PIN	P
		MIN. O.D.	MAX. O.D.			
PTA 1/0	#10 sol.-1/0 ACSR	.102	.398	VC 5/6	#2	6
PTA 4/0	#4 sol.-4/0 ACSR	.204	.563	VC 5/6	2/0	
PTA 350	2/0 str.-336.4 (18/1) ACSR	.414	.684	VC 6	4/0	

Note: For tin-plating option, add "-TN" suffix to the catalog number.
For other pin lengths, please contact your Thomas & Betts representative.

Aluminum Lugs

Compress these lugs with standard tools and dies.

Slotted-Tang Compression Terminal Lugs

- Dual-rated for use with a wide range of aluminum and copper conductors
- Prefilled with oxide inhibitor to prevent oxidation and keep out moisture
- Small boss on both sides of lug tang fits the indent on the bus, preventing the lug from rotating
- Slot enables lug to be bolted to the bus, so the bus doesn't have to be removed
- RUS Accepted

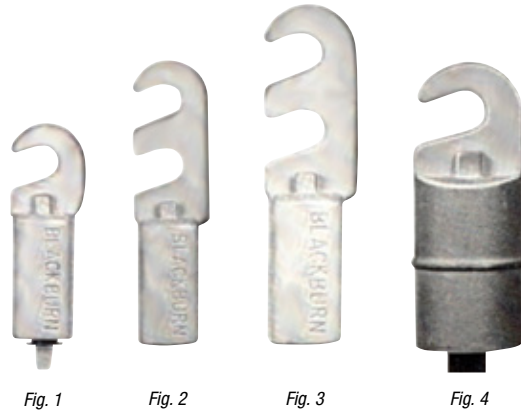

CAT. NO.	COLOR CODE	CONDUCTOR SIZE			FIG. NO.	INSTALLATION DIES	
		CONCENTRIC	COMPRESSED COMPACT	SOL.		MECH. TOOLS	HYDR. TOOLS
LAC6	Blue	#6 str.	#6	#5 sol.	1	BY37, 840	B49EA, U-K840
LAC4	Orange	#4 str.	#4	#3 sol.			
LAC3	Purple	#3 str.	—	#2 sol.			
LAC2	Red	#2 str.	#2	#1 sol.			
LAC1	White	#1 str.	#1	1/0 sol.			
LAC10	Yellow	1/0 str.	1/0	2/0 sol.	2	BY37, 840U	B49EA, K840
LAC20	Gray	2/0 str.	2/0	3/0 sol.			
LAC30	Black	3/0 str.	3/0	4/0 sol.			
LAC40	Pink	4/0 str.	4/0	—			
LAC42	Orange	#4 str.	#4	#3 sol.			
LAC32	Purple	#3 str.	—	#2 sol.			
LAC22	Red	#2 str.	#2	#1 sol.			
LAC12	White	#1 str.	#1	1/0 sol.			
LAC102	Yellow	1/0 str.	1/0	2/0 sol.	3	—	B80EA, 1.1, 655
LAC25	Green	350, 266.6	250	—			
LAC35	Brown	300, 350	350	—	4	—	B80EA, 1.1, 655
LAC50	Aqua	400, 500	500	—			
LAC125	Green	250, 266.8	250	—			
LAC135	Brown	300, 350	350	—			
LAC150	Aqua	400, 500	500	—			

Aluminum Lugs

Corrosion-resistant one- and two-hole lugs for ACSR and aluminum conductors.

Bi-Metallic Lugs

- Aluminum barrel provides high strength
- Tin-plated copper pad provides high conductivity and corrosion resistance
- Prefilled with oxide inhibitor to prevent oxidation and keep out moisture



CPL Series — One-Hole

CAT. NO.	CONDUCTOR SIZE		BOLT SIZE
	ACSR	AL	
CPL 4-48	#4	#4	1/2
CPL 2-48	#2	#2	
CPL 1/0-48	1/0	1/0	
CPL 4/0-48	4/0	4/0	

CPL-N Series — Two-Hole

CAT. NO.	CONDUCTOR SIZE		BOLT SIZE
	ACSR	AL	
CPL 4 N	#4	#4	1/2
CPL 2 N	#2	#2	
CPL 1/0 N	1/0	1/0	
CPL 2/0 N	2/0	2/0	
CPL 3/0 N	3/0	3/0	
CPL 4/0 N	4/0	4/0-250	
CPL 300 N	266.8	266.8-300	
CPL 350 N	336.4	336.4-350	
CPL 477 N	397.5	396.5-477	
CPL 556 N	477	500-556.5	
CPL 600 N	556.5	600	
CPL 800 N	605-666.6	715.5-800	
CPL 1000 N	715.5-874.5	874.5-1000	
CPL 1113 N	900-1113	1033.5-1113	
CPL 2000 N	1780-1900	2000	

Aluminum Splices

For general applications.

Aluminum Tin-Plated Straight Splices

- Made from aluminum for high strength and high conductivity
- Solid center stop ensures proper cable insertion
- Dual-rated for use with aluminum and copper conductors
- Prefilled with oxide inhibitor to prevent oxidation and keep out moisture
- All splices marked with conductor sizes and die references for easy identification
- Meet or exceed ANSI C119.4 specifications; splices with tin plating are UL® Listed through 1000 kcmil

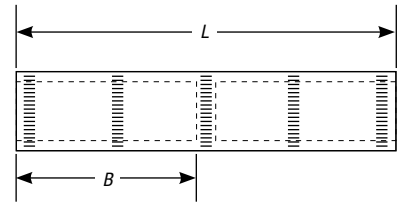

CAT. NO.	CONCENTRIC	COMPACT	ACSR	L	B	INSTALLING DIES
ASC 6	#6	—	—	1 $\frac{5}{8}$	$\frac{3}{4}$	TP, 29, 161, $\frac{5}{16}$
ASC 4	#4	—	—	2	1	TB, 37, 375, 162
ASC 2	#2	—	—	2	1 $\frac{5}{16}$	TQ, 45, 348, 163, $\frac{1}{2}$, 6A
ASC 1	#1	—	—	2	1 $\frac{5}{16}$	TQ, 45, 348, 163, $\frac{1}{2}$
ASC 1/0	1/0	—	—	2 $\frac{1}{4}$	3 $\frac{3}{32}$	TU, 52, BG, 243, $\frac{5}{8}$
ASC 2/0	2/0	—	—	2 $\frac{5}{16}$	1 $\frac{1}{2}$	TW-TY, 58, 297, $\frac{5}{8}$ -1
ASC 3/0	3/0	—	—	2 $\frac{5}{8}$	1 $\frac{1}{4}$	TV, 66, 167, 467, 10A
ASC 4/0	4/0	—	—	2 $\frac{3}{4}$	1 $\frac{5}{16}$	TX, 71H, 298, 840, 11A
ASC 250	4/0–250	300	4/0	2 $\frac{15}{16}$	1 $\frac{3}{8}$	TX, 76, 249, 840, 11A
ASC 300	266.8–300	350	266.8 (18/1)	3 $\frac{1}{8}$	1 $\frac{1}{16}$	TH, 87H, 251, 470, 1, 12A
ASC 350	336.4–350	400	266.8 (26/7), 336.4 (18/1)	3 $\frac{3}{8}$	1 $\frac{39}{64}$	96, 299, 655, 1 $\frac{1}{8}$ -1, 13A
ASC 400	397.5–400	—	336.4 (26/7), 397.5 (18/1)	3 $\frac{1}{4}$	1 $\frac{1}{4}$	96, 472, 655, 1 $\frac{1}{8}$ -1, 13A
ASC 500	477–500	600	397.5 (26/7), 477 (18/1)	3 $\frac{7}{8}$	1 $\frac{27}{32}$	106A, 300, 317, 1 $\frac{1}{16}$, 14A
ASC 600	550–600	—	477 (26/7), 556.5 (18/1)	4 $\frac{1}{8}$	1 $\frac{15}{16}$	1 $\frac{1}{16}$, 115H, 786, 936, 473
ASC 750	700–750	—	636 (26/7)	4 $\frac{11}{16}$	2 $\frac{1}{32}$	140H, 301, 342, 1 $\frac{1}{2}$
ASC 750-608*	700–750	—	636 (26/7)	4 $\frac{11}{16}$	2 $\frac{1}{32}$	125H, 608, 786, 1 $\frac{1}{2}$, 936
ASC 800	800	—	—	4 $\frac{3}{4}$	2 $\frac{1}{4}$	140H, 342, 474, 1 $\frac{1}{2}$
ASC 1000	954–1000	—	795 (26/7), 954 (45/7)	5 $\frac{1}{4}$	2 $\frac{3}{8}$	161, 292, 302, 319, 1 $\frac{3}{4}$
ASC 1250	1250	—	—	8	3 $\frac{11}{16}$	161, 727, 352, 1 $\frac{3}{8}$
ASC 1500	1500	—	—	6 $\frac{1}{2}$	3 $\frac{3}{8}$	189, 478, 728

* Not UL Listed.

Note: For splices with tin plating, add "-TN" suffix to the catalog number.
Splices with tin plating are UL Listed through 1000 kcmil.

Aluminum Splices

Splices for general applications.

Aluminum Straight Splices

- Made from aluminum for high strength and high conductivity
- Solid center stop ensures proper cable insertion
- Dual-rated for use with aluminum and copper conductors
- Connector bores coated with oxide inhibitor and capped to prevent oxidation and keep out moisture
- All splices marked with conductor sizes and die references for easy identification
- Meets or exceeds ANSI C119.4 specifications; all tin-plated splices are UL® Listed

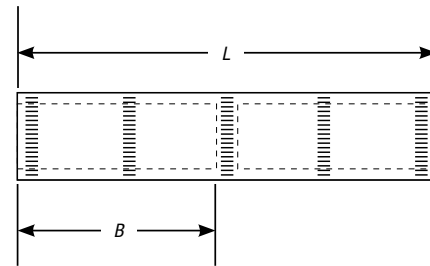

CAT. NO.	CONCENTRIC	COMPACT	ACSR	L	B	INSTALLING DIES
AC 4	#4	—	—	2¼	1	TB, 37, 375
AC 2	#2	—	—	3 ¹⁵ / ₃₂	1 ³⁷ / ₆₄	TQ, 45, 348, 163, ½
AC 1	#1	—	—	3 ¹⁵ / ₃₂	1 ³⁷ / ₆₄	TQ, 45, 348, 163, ½
AC 1/0	1/0	—	—	3 ¹ / ₁₆	1 ¹³ / ₃₂	TU, 52, BG, 243, ⅝, 8A
AC 2/0	2/0	—	—	3 ¹ / ₁₆	1 ¹³ / ₃₂	TU, 52, BG, 243, ⅝, 8A
AC 3/0	3/0	—	—	4	1¾	TV, 66, 167, 781, 247, 10A
AC 4/0	4/0	250	—	3¾	1¾	TX, 71H, 298, 840, 660, 11A
AC 250	4/0-250	—	4/0	5¼	2 ⁵ / ₁₆	TX, 76, 249, 840, 11A
AC 300	266.8-300	—	266.8 (18/1)	5¾	2 ¹ / ₁₆	TH, 87H, 251, 840, 470, 12A
AC 350	336.4-350	—	266.8 (26/7), 336.4 (18/1)	6 ⁵ / ₈	3 ¹ / ₈	96, 299, 655, 1 ¹ / ₈ -1, 13A
AC 400	397.5-400	—	336.4 (26/7), 397.5 (18/1)	7 ⁹ / ₃₂	3 ¹ / ₂	96, 472, 655, 705, 1 ¹ / ₈ -1, 13A
AC 500	477-500	600	397.5 (26/7, 30/7), 477 (18/1)	7 ¹⁹ / ₃₂	3 ³⁷ / ₆₄	106A, 300, 317, ¹⁵ / ₁₆ , 14A
AC 600	600	—	477 (26/7), 556.5 (18/1)	7 ⁷ / ₃₂	3 ⁴⁷ / ₆₄	¹⁵ / ₁₆ , 115H, 786, 936, 473
AC 750	700-750	—	636 (26/7)	8 ⁹ / ₃₂	3 ³¹ / ₃₂	140H, 301, 342, 1½
AC 800	750-800	—	636 (30/19), 715.5 (54/7)	8½	4 ¹ / ₁₆	140H, 474, 342, 724, 1½H, 1½
AC 1000	954-1000	—	795 (26/7), 954 (45/7)	9 ⁵ / ₁₆	4 ⁹ / ₃₂	161, 292, 302, 319, 1¾

Note: For tin-plating option, add "-TN" suffix to the catalog number.

Aluminum Splices

Solid center stop ensures proper cable insertion.

Aluminum Straight Reducing Splices

- Made from aluminum for high strength and high conductivity.
- Dual-rated for use with aluminum and copper conductors
- Connector bores coated with oxide inhibitor and capped to prevent oxidation
- All splices marked with conductor sizes and die references for easy identification
- Meets or exceeds ANSI C119.4 specifications:

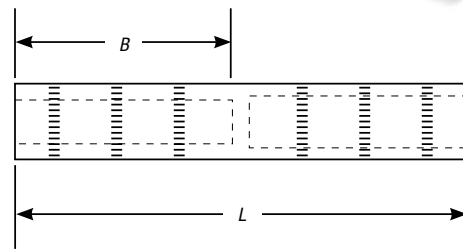

CAT. NO.	WIRE SIZE		L	B	INSTALLING DIES
	FROM	TO			
AC 2 R 4	#2	#4	4 ⁹ / ₁₆	1 ⁷ / ₈	TQ, 45, 348, 6A, ½
AC 1/0 R 2	1/0	#2	4 ⁹ / ₁₆	1 ⁷ / ₈	8A, BG, TU, ⅝
AC 2/0 R 1	2/0	#1	4 ⁹ / ₁₆	1 ⁷ / ₈	TWTY, 60, 245, 9A, ⅝ 1
AC 3/0 R 1/0	3/0	1/0	5	2	781, TU, 56
AC 4/0 R 2/0	4/0	2/0	5 ¹ / ₄	2 ¹ / ₈	TX, 71H, 298, 11A, 840
AC 250 R 3/0	250	3/0	5 ¹ / ₄	2 ¹ / ₈	840, 11A, 249, TX
AC 300 R 4/0	300	4/0	8 ³ / ₁₆	3 ¹⁷ / ₃₂	96, 299, 1 ¹ / ₈
AC 350 R 4/0	350	4/0	8 ³ / ₁₆	3 ¹⁷ / ₃₂	96, 299, 1 ¹ / ₈
AC 400 R 250	400	250	8 ⁹ / ₃₂	3 ¹¹ / ₁₆	96, 472, 1 ¹ / ₈
AC 500 R 300	500	300	8 ⁹ / ₃₂	3 ¹³ / ₁₆	106, 300, 317, 1 ¹⁵ / ₁₆
AC 500 R 350	500	350	8 ¹¹ / ₁₆	3 ¹³ / ₁₆	106, 300, 317, 1 ¹⁵ / ₁₆
AC 500 R 400	500	400	8 ⁷ / ₈	3 ¹³ / ₁₆	106, 300, 317, 1 ¹⁵ / ₁₆
AC 600 R 350	600	350	8 ⁷ / ₈	3 ¹⁵ / ₁₆	115, 473, 1 ¹⁵ / ₁₆
AC 600 R 500	600	500	9 ¹ / ₄	3 ¹⁵ / ₁₆	115, 473, 1 ¹⁵ / ₁₆
AC 750 R 500	750	500	9 ⁷ / ₈	4 ¹ / ₃₂	140, 301, 1 ¹ / ₂
AC 750 R 600	750	600	9 ⁷ / ₈	4 ⁷ / ₃₂	140, 301, 1 ¹ / ₂
AC 1000 R 500	1000	500	9 ⁷ / ₈	4 ⁷ / ₈	161, 302, 1 ³ / ₄
AC 1000 R 750	1000	750	9 ⁷ / ₈	4 ⁷ / ₈	161, 302, 1 ³ / ₄

Note: For tin-plating option, add "-TN" suffix to the catalog number.

Aluminum Splices

Splices designed for general URD applications.

Aluminum Straight Splices — Common Die Series

- Entire conductor range installed with six common dies to reduce your die inventory
- Made from aluminum for high strength and high conductivity
- Solid center stop ensures proper cable insertion
- Dual-rated for use with aluminum and copper conductors
- Connector bores coated with oxide inhibitor to prevent oxidation
- All splices marked with conductor sizes and die references easy identification
- Meets or exceeds ANSI C119.4 specifications

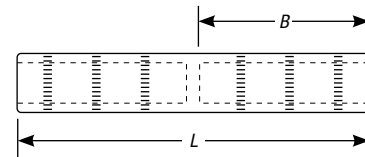

CAT. NO.	CONCENTRIC	COMPRESSED	COMPACT	SOLID	B	L	INSTALLING DIES
SAC 4	#4	#4	#4	—	1 ³ / ₃₂	3	⅝, 8A, BG, TU, 52
SAC 2	#2	#2	#1, #2	#1	1 ³ / ₃₂		CSA 22, ⅝, 8A, BG
SAC 1	#1	#1	1/0	1/0	1 ³ / ₃₂		CSA 22, ⅝, 8A, BG
SAC 1/0	1/0	1/0	2/0	2/0	1 ³ / ₃₂		CSA 22, ⅝, 8A, BG
SAC 2/0	2/0	2/0	3/0	3/0	1 ¹ / ₈	4	840, 249, TX, CSA 24
SAC 3/0	3/0	3/0	4/0	—	1 ¹ / ₈		840, 249, TX, CSA 24, 845
SAC 4/0	4/0	4/0	4/0, 250	—	1 ¹ / ₈		840, 249, TX, CSA 24, 845
SAC 250	250	250	—	—	1 ¹ / ₈	5	840, 249, TX, CSA 24, 11A
SAC 300	300	300	—	—	2 ³ / ₁₆		96, 299, 655, 1 ¹ / ₈ -1, 13A
SAC 350	350	350	—	—	2 ³ / ₁₆	5 ¹ / ₁₆	96, 299, 655, 321, 1 ¹ / ₈ -1, 13A
SAC 400	400	400	500	—	2 ³ / ₁₆		106A, 300, 317, 15A
SAC 500	477–500	—	600	—	2 ³ / ₁₆	7	106A, 300, 317, 1 ¹ / ₈ , 15A
SAC 600	600	—	—	—	3 ³ / ₁₆		1 ¹ / ₂ , 140, 301, 724
SAC 750	700–750	—	—	—	3 ³ / ₁₆		140H, 301, 342, 724, 1 ¹ / ₂
SAC 1000	1000	—	—	—	3 ³ / ₁₆	1 ¹ / ₄ , 161, 302, 292, 319	

Aluminum Splices

Reducers for general URD applications.

Aluminum Straight Reducing Splices — Common Die Series

- Install with six common dies to reduce your die inventory
- Dual-rated for use with aluminum and copper conductors
- Bores coated with oxide inhibitor to prevent oxidation
- Marked with conductor sizes and die references for easy identification
- Meets or exceeds ANSI C119.4 specifications

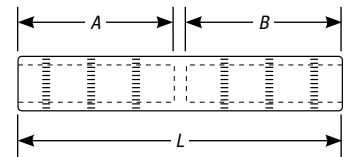

CAT. NO.	SIDE A			SIDE B			A-B	L	INSTALLING DIES
	CONCENTRIC/ COMPRESSED	COMPACT	SOLID	CONCENTRIC/ COMPRESSED	COMPACT	SOLID			
SAC 4 R 6	#4	#4	—	#6	#6	—	1 ¹ / ₁₆	3	CSA 22, 24, BG, 243
SAC 2 R 4	#2	#1, #2	#1	#4	#4	—			
SAC 1 R 2	#1	1/0	1/0	#2	#1, #2	#1			
SAC 1/0 R 4	1/0	2/0	2/0	#4	#4	—			
SAC 1/0 R 2	1/0	2/0	2/0	#2	#1, #2	#1			
SAC 1/0 R 1	1/0	2/0	2/0	#1	1/0	1/0			
SAC 2/0 R 2	2/0	3/0	3/0	#2	#1, #2	#1	1 ¹ / ₈	4	840, 249, TX, CSA 24
SAC 2/0 R 1/0	2/0	3/0	3/0	1/0	2/0	2/0			
SAC 3/0 R 1/0	3/0	4/0	—	1/0	2/0	2/0			
SAC 3/0 R 2/0	3/0	4/0	—	2/0	3/0	3/0			
SAC 4/0 R 2	4/0	250	—	#2	#1, #2	#1			
SAC 4/0 R 1/0	4/0	250	—	1/0	2/0	2/0			
SAC 4/0 R 2/0	4/0	250	—	2/0	3/0	3/0	2 ³ / ₈	5	96, 299, 655, 1 ¹ / ₈ -1, 13A
SAC 250 R 3/0	250	—	—	3/0	4/0	—			
SAC 250 R 4/0	250	—	—	4/0	250	—			
SAC 300 R 250	300	—	—	4/0-250	—	—			
SAC 350 R 2	350	—	—	#2	#1, #2	#1			
SAC 350 R 1/0	350	—	—	1/0	2/0	2/0			
SAC 350 R 2/0	350	—	—	2/0	3/0	3/0	2 ² / ₃₂	5 ¹ / ₁₆	1 ¹ / ₁₆ , 5A, 300, 106, 317
SAC 350 R 3/0	350	—	—	3/0	4/0	—			
SAC 350 R 4/0	350	—	—	4/0	250	—			
SAC 350 R 250	350	—	—	250	—	—			
SAC 500 R 2	500	—	—	#2	—	—			
SAC 500 R 1/0	500	—	—	1/0	—	—			
SAC 500 R 2/0	500	—	—	2/0	—	—	3	6 ¹ / ₄	140H, 301, 342
SAC 500 R 3/0	500	—	—	3/0	—	—			
SAC 500 R 4/0	500	—	—	4/0	250	—			
SAC 500 R 300	500	—	—	300	—	—			
SAC 500 R 350	500	—	—	350	—	—			
SAC 500 R 400	500	—	—	400	—	—			
SAC 750 R 1/0	750	—	—	1/0	—	—	3 ³ / ₈	7	161, 302, 292, 319, 1 ³ / ₄
SAC 750 R 4/0	750	—	—	4/0	250	—			
SAC 750 R 250	750	—	—	250	—	—			
SAC 750 R 350	750	—	—	350	—	—			
SAC 750 R 500	750	—	—	500	—	—			
SAC 1000 R 400	1000	—	—	400	—	—			
SAC 1000 R 500	1000	—	—	500	—	—	750	—	—
SAC 1000 R 750	1000	—	—	750	—	—			

Note: For tin-plating option, add "-TN" suffix to the catalog number.

Aluminum Splices

Built to resist corrosion and provide high strength and high conductivity.

Aluminum Tin-Plated Straight Splices — 5/8 Common Die Series

- Made from aluminum for high strength and high conductivity
- Solid center stop ensures accurate wire positioning and forces oxide inhibitor over and through conductor strands
- Most are dual-rated for use with aluminum and copper conductors
- Tin plated to resist corrosion and extend shelf life
- Prefilled with oxide inhibitor to improve contact and seal out moisture after installation
- Color-coded end caps seal splices from contaminants
- All splices marked with conductor sizes, die references and compression locations for easy identification and installation
- Meets or exceeds ANSI C119.4 specifications

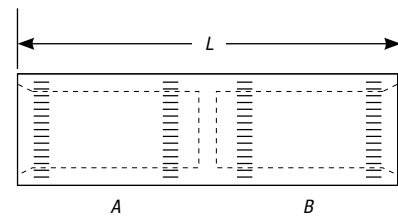

CAT. NO.	WIRE SIZE		CONDUCTOR		INSTALLING DIES	L
	A	B	A	B		
SG 88	#8	#8	AL-CU	AL-CU	5/8, 8A, BG, TU, 243	2
SG 68	#6	#8	AL-CU	AL-CU		
SG 66	#6	#6	AL-CU	AL-CU		
SG 48	#4	#8	AL-CU	AL-CU		
SG 46	#4	#6	AL-CU	AL-CU		
SG 44	#4	#4	AL-CU	AL-CU		
SG 26	#2	#6	AL-CU	AL-CU		
SG 24	#2	#4	AL-CU	AL-CU		
SG 22	#2	#2	AL-CU	AL-CU		
SG 11	#1	#1	AL-CU	AL-CU		
SG 106	1/0	#6	AL-CU	AL-CU		
SG 104	1/0	#4	AL-CU	AL-CU		
SG 102	1/0	#2	AL-CU	AL-CU		
SG 1010	1/0	1/0	AL-CU	AL-CU		
SG 206	2/0	#6	AL	AL-CU		2 1/8
SG 204	2/0	#4	AL	AL-CU		
SG 202	2/0	#2	AL	AL-CU		
SG 2010	2/0	1/0	AL	AL-CU		
SG 2020	2/0	2/0	AL	AL		

Note: For watertight protection, see the FSS 20 Flood-Seal® insulating splice cover on page F-378.

Aluminum Splices

Tapered ends enable use in high-voltage applications up to 69kV.

Aluminum Tapered Splices

- Solid center stop ensures proper cable insertion
- Dual-rated for use with aluminum and copper conductors
- Connector bores coated with oxide inhibitor to prevent oxidation
- All splices marked with die references for easy identification
- Meets or exceeds ANSI C119.4 specifications

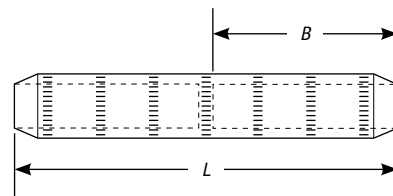

CAT. NO.	CONCENTRIC	L	B	INSTALLING DIES
ATC 3	#3	2 ²³ / ₃₂	1 ¹ / ₃₂	½, TQ, 6A, 163
ATC 2	#2	2 ²³ / ₃₂	1 ¹ / ₃₂	½, TQ, 6A, 163
ATC 1	#1	3	1 ¹³ / ₃₂	TU, 52, BG, 243, ⅝, 8A
ATC 1/0	1/0	3	1 ¹³ / ₃₂	⅝, TU, BG, 296
ATC 2/0	2/0	3 ¹ / ₁₆	1 ¹ / ₈	TW-TY, 58, 297, ⅝-1
ATC 3/0	3/0	3	1 ¹ / ₈	TV, 66, 247
ATC 4/0	4/0	3 ²³ / ₃₂	1 ²³ / ₃₂	TX, 71H, 298, 840
ATC 250	250	3 ² / ₃₂	1 ⁴ / ₆₄	TX, 76, 249, 840, 11A
ATC 300	300	4 ⁷ / ₁₆	2 ¹ / ₃₂	1, TH, 87H, 470, 251, 12A
ATC 350	350	5	2 ² / ₆₄	96, 472, 655, 1 ¹ / ₈ -1, 13A
ATC 400	400	5 ⁷ / ₃₂	2 ²⁵ / ₆₄	96, 472, 655, 705, 1 ¹ / ₈ -1, 13A
ATC 500	500	5 ¹ / ₂	2 ¹⁹ / ₃₂	1 ¹ / ₁₆ , 106A, 300, 317, 15A
ATC 600	600	5 ²⁹ / ₃₂	2 ¹ / ₁₆	115H, 786, 936, 1 ¹ / ₁₆
ATC 750	700–750	6 ²³ / ₆₄	3 ³ / ₈	140H, 301, 342, 1 ¹ / ₂
ATC 800	795–800	7 ⁷ / ₁₆	3 ¹⁵ / ₃₂	140, 1 ¹ / ₂ , 1 ¹ / ₈
ATC 1000	1000	8 ²⁷ / ₃₂	4 ⁷ / ₆₄	161, 302, 292, 319, 1 ³ / ₄
ATC 1250	1250	9 ³ / ₄	4 ¹¹ / ₁₆	161, 352, 579, 30AH
ATC 1500	1500	9 ³ / ₄	4 ¹¹ / ₁₆	189R, 478, L46ART
ATC 1750	1750	11 ¹ / ₂	5 ⁷ / ₃₂	189, 728, 38AH
ATC 2000	2000	14	6 ¹ / ₁₆	189, 478, 728

Note: For tin-plating option, add "-TN" suffix to the catalog number.

Aluminum Splices

Tapered ends enable use in high-voltage applications up to 69kV.

Aluminum Tapered Reducing Splices

- Solid center stop ensures proper cable insertion, prevents moisture migration
- Dual-rated for use with aluminum and copper conductors
- Connector bores are coated with oxide inhibitor to prevent oxidation
- All splices marked with conductor sizes and die references for easy identification
- Meets or exceeds ANSI C119.4 specifications

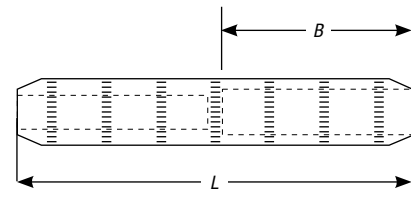

CAT. NO.	WIRE SIZE		L	B	INSTALLING DIES
	FROM	TO			
ATC 2 R 4	#2	#4	2 $\frac{1}{2}$	1 $\frac{3}{8}$	$\frac{1}{2}$
ATC 1/0 R 4	1/0	#4	3	1 $\frac{1}{16}$	
ATC 1/0 R 2	1/0	#2	3	1 $\frac{1}{16}$	
ATC 2/0 R 2	2/0	#2	4	1 $\frac{1}{8}$	
ATC 2/0 R 1/0	2/0	1/0	4	1 $\frac{1}{8}$	
ATC 3/0 R 1/0	3/0	1/0	4	1 $\frac{1}{8}$	
ATC 4/0 R 1/0	4/0	1/0	4	1 $\frac{1}{8}$	249, 840, TX, 76, 11A
ATC 4/0 R 2/0	4/0	2/0	4	1 $\frac{1}{8}$	
ATC 4/0 R 2	4/0	#2	4	1 $\frac{1}{8}$	
ATC 250 R 3/0	250	3/0	4	1 $\frac{1}{8}$	
ATC 350 R 2	350	#2	4 $\frac{1}{16}$	2 $\frac{3}{8}$	
ATC 350 R 1/0	350	1/0	4 $\frac{1}{16}$	2 $\frac{3}{8}$	
ATC 350 R 2/0	350	2/0	4 $\frac{1}{16}$	2 $\frac{3}{8}$	655, 299, 1-18-1, 96, 13A
ATC 350 R 3/0	350	3/0	4 $\frac{1}{16}$	2 $\frac{3}{8}$	
ATC 350 R 4/0	350	4/0	4 $\frac{1}{16}$	2 $\frac{3}{8}$	
ATC 350 R 250	350	250	4 $\frac{1}{16}$	2 $\frac{3}{8}$	
ATC 500 R 2	500	#2	5 $\frac{1}{2}$	2 $\frac{1}{16}$	
ATC 500 R 1/0	500	1/0	5 $\frac{1}{2}$	2 $\frac{1}{16}$	
ATC 500 R 2/0	500	2/0	5 $\frac{1}{2}$	2 $\frac{1}{16}$	
ATC 500 R 4/0	500	4/0	5 $\frac{1}{2}$	2 $\frac{1}{16}$	300, 317, 1 $\frac{1}{16}$, 106, 15A
ATC 500 R 250	500	250	5 $\frac{1}{2}$	2 $\frac{1}{16}$	
ATC 500 R 300	500	300	5 $\frac{1}{2}$	2 $\frac{1}{16}$	
ATC 500 R 350	500	350	5 $\frac{1}{2}$	2 $\frac{1}{16}$	
ATC 500 R 350-608	500	350	5 $\frac{1}{2}$	2 $\frac{1}{16}$	125H, 608, 786, 936
ATC 750 R 2	750	#2	9 $\frac{1}{2}$	4 $\frac{1}{2}$	
ATC 750 R 1/0	750	1/0	9 $\frac{1}{2}$	4 $\frac{1}{2}$	
ATC 750 R 4/0	750	4/0	9 $\frac{1}{2}$	4 $\frac{1}{2}$	301, 1 $\frac{1}{2}$, 140, 342
ATC 750 R 350	750	350	9 $\frac{1}{2}$	4 $\frac{1}{2}$	
ATC 750 R 500	750	500	9 $\frac{1}{2}$	4 $\frac{1}{2}$	
ATC 750 R 500-608	750	500	9 $\frac{1}{2}$	4 $\frac{1}{2}$	125H, 608, 786, 936
ATC 1000 R 500	1000	500	9 $\frac{1}{2}$	4 $\frac{1}{2}$	
ATC 1000 R 750	1000	750	9 $\frac{1}{2}$	4 $\frac{1}{2}$	302, 161, 292, 319, 727
ATC 1250 R 750	1250	750	9 $\frac{1}{2}$	4 $\frac{1}{2}$	

Note: For tin-plating option, add "-TN" suffix to the catalog number.

Aluminum Splices

Entire conductor range is installed with six common dies.

Aluminum Tapered Splices — Common Die Series

- Solid center stop ensures proper cable insertion, prevents moisture migration
- Dual-rated for use with aluminum and copper conductors
- Connector bores are coated with oxide inhibitor to prevent oxidation
- All splices marked with die references for easy identification
- Meets or exceeds ANSI C119.4 specifications

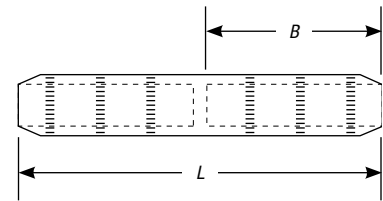

CAT. NO.	WIRE SIZE	L	B	INSTALLING DIES
SATC 4	#4	3	1 ¹ / ₁₆	52, TU, 243, 5/8, BG
SATC 2	#2		1 ¹ / ₁₆	
SATC 1	#1		1 ¹ / ₁₆	
SATC 1/0	1/0		1 ¹ / ₁₆	
SATC 2/0	2/0	4	1 ¹ / ₁₆	TX, 76, 11A, 249, 840
SATC 3/0	3/0		1 ¹ / ₁₆	
SATC 4/0	4/0		1 ⁷ / ₈	
SATC 250	250		1 ¹ / ₁₆	
SATC 300	300	5	2 ³ / ₁₆	96, 13A, 1 ¹ / ₈ -1, 299, 321, 655
SATC 350	350		2 ³ / ₁₆	
SATC 400	400	5 ¹ / ₂	2 ³ / ₈	96, 472, 655, 1 ¹ / ₈ -1, 13A
ATC 500	500		2 ³ / ₈	
SATC 750	700-750	7	3 ³ / ₈	140, 301, 342, 1 ¹ / ₂

Note: For tin-plating option, add "-TN" suffix to the catalog number.

Tees

For aluminum and copper connections, these dual-rated components suit you to a tee.

Aluminum Tees

- Made from aluminum for high strength and high conductivity
- Dual-rated for use with aluminum and copper conductors
- Connector bores coated with oxide inhibitor to prevent oxidation
- All tees marked with conductor sizes and die references for easy identification
- Meets or exceeds ANSI C119.4 specifications



AT 350-350

CAT. NO.	RUN	TAP	L	T
AT 2-4	#2	#4	5½	2½
AT 2-2		#2		
AT 1/0-4	1/0	#4		
AT 1/0-2		#2		
AT 1/0-1/0	1/0			
AT 2/0-2	2/0	#2		
AT 2/0-1/0		1/0		
AT 2/0-2/0	2/0			
AT 3/0-2	3/0	#2	6	3
AT 3/0-1/0		1/0		
AT 3/0-3/0	3/0			
AT 4/0-2	4/0	#2		
AT 4/0-1/0		1/0		
AT 4/0-2/0	2/0			
AT 4/0-4/0	4/0			
AT 250-2	250	#2	6¾	3¾
AT 250-1/0		1/0		
AT 250-2/0		2/0		
AT 250-3/0		3/0		
AT 250-250		250		
AT 300-1/0	300	1/0		
AT 300-2/0		2/0		
AT 300-4/0		4/0		
AT 300-300		300		

CAT. NO.	RUN	TAP	L	T	
AT 350-2	350	#2	6¾	2½	
AT 350-1/0		1/0		2½	
AT 350-3/0	3/0	3			
AT 350-4/0	4/0	3			
AT 350-350	350	3¾			
AT 500-1/0	500	1/0		8	3
AT 500-4/0		4/0	3		
AT 500-350	350	3¾			
AT 500-500	500	3¾			
AT 750-1/0	750	1/0	9		2½
AT 750-4/0		4/0			3
AT 750-350	350	3¾			
AT 750-500	500	3¾			
AT 750-750	750	3½			
AT 1000-4/0	1000	4/0		9¾	3¾
AT 1000-350		350	3¾		
AT 1000-500		500	5½		
AT 1000-750		750	7½		
AT 1000-1000	1000	7½			

Note: For tin-plating option, add "-TN" suffix to the catalog number.
For other available sizes, please consult your Thomas & Betts representative.

Tees

Tees available in many run and tap sizes for your high-voltage applications.

Aluminum Tapered Tees

- Made from aluminum for high strength and high conductivity
- Tapered ends enable use in high-voltage applications up to 69kV
- Dual-rated for use with aluminum and copper conductors
- Connector bores coated with oxide inhibitor to prevent oxidation
- All tees marked with conductor sizes and die references for easy identification
- Meets or exceeds ANSI C119.4 specifications

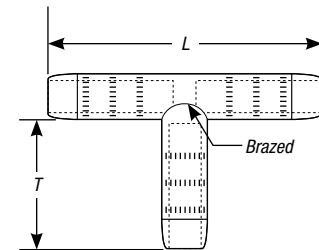

CAT. NO.	RUN	TAP	L	T
ATT 2-4	#2	#4	4¼	2½
ATT 2-2		#2		2½
ATT 1/0-4	1/0	#4	5½	2½
ATT 1/0-2		#2		2½
ATT 1/0-1/0	2/0	1/0	6	2½
ATT 2/0-2		#2		2½
ATT 2/0-1/0	2/0	1/0	6	2½
ATT 2/0-2/0		2/0		2½
ATT 3/0-2	3/0	#2	6%	3
ATT 3/0-1/0		1/0		3
ATT 3/0-3/0	4/0	3/0	6%	3
ATT 4/0-2		#2		2½
ATT 4/0-1/0	4/0	1/0	6%	2½
ATT 4/0-2/0		2/0		2½
ATT 4/0-4/0	250	4/0	6%	3
ATT 250-2		#2		3
ATT 250-1/0	250	1/0	6%	3
ATT 250-2/0		2/0		3
ATT 250-3/0	300	3/0	6%	3
ATT 250-250		250		3
ATT 300-1/0	300	1/0	6%	3½
ATT 300-2/0		2/0		3½
ATT 300-4/0	300	4/0	6%	3½
ATT 300-300		300		3½

CAT. NO.	RUN	TAP	L	T
ATT 350-2	350	#2	6%	2½
ATT 350-1/0		1/0		2½
ATT 350-3/0	400	3/0	7¾	3
ATT 350-4/0		4/0		3
ATT 350-350	500	350	8	3¼
ATT 400-1/0		1/0		4
ATT 400-4/0	400	4/0	7¾	4
ATT 400-400		400		4
ATT 500-1/0	500	1/0	8	4
ATT 500-4/0		4/0		3
ATT 500-350	750	350	9	3½
ATT 500-500		500		5½
ATT 750-1/0	750	1/0	9	3
ATT 750-4/0		4/0		3
ATT 750-350	1000	350	9%	3½
ATT 750-500		500		5½
ATT 750-750	1000	750	9%	4
ATT 1000-4/0		4/0		3½
ATT 1000-350	1000	350	9%	3½
ATT 1000-500		500		5½
ATT 1000-750	1500	750	14	6
ATT 1000-1000		1000		6
ATT 1500-1500	1500	1500	14	6

Note: For tin-plating option, add "-TN" suffix to the catalog number.
For other available sizes, please consult your Thomas & Betts representative.

Tees

Tees available in many run and tap sizes for various copper conductors.

Copper Tin-Plated Tees

- Made from tin-plated copper for high conductivity, resistance to corrosion
- All tees marked with conductor sizes and die references for easy identification



250 T 250

CAT. NO.	CONDUCTOR SIZE	
	RUN	TAP
2 T 2	#2	#2
1/0 T 6	1/0	#6
1/0 T 4		#4
1/0 T 2		#2
1/0 T 1		#1
1/0 T 1/0		1/0
2/0 T 6	2/0	#6
2/0 T 4		#4
2/0 T 2		#2
2/0 T 1		#1
2/0 T 1/0		1/0
2/0 T 2/0	2/0	
3/0 T 1/0	3/0	1/0
3/0 T 3/0		3/0
4/0 T 2	4/0	#2
4/0 T 1		#1
4/0 T 1/0		1/0
4/0 T 2/0		2/0
4/0 T 4/0		4/0
250 T 2	250	#2
250 T 1		#1
250 T 1/0		1/0
250 T 2/0		2/0
250 T 4/0		4/0
250 T 250	250	
300 T 300	300	300

CAT. NO.	CONDUCTOR SIZE	
	RUN	TAP
350 T 1/0	350	1/0
350 T 2/0		2/0
350 T 4/0		4/0
350 T 350		350
400 T 1/0	400	1/0
400 T 2/0		2/0
400 T 4/0		4/0
400 T 250		250
400 T 300		300
400 T 350	350	
400 T 400	400	
500 T 1/0	500	1/0
500 T 2/0		2/0
500 T 4/0		4/0
500 T 250		250
500 T 350		350
500 T 400	400	
500 T 500	500	
600 T 2/0	600	2/0
600 T 4/0		4/0
600 T 350		350
600 T 500		500
600 T 600	600	
750 T 350	750	350
750 T 500		500
750 T 750		750
1000 T 500	1000	500
1000 T 1000		1000

Tees

Tapered ends enable use in high-voltage applications up to 69kV.

Copper Tin-Plated Tapered Tees

- Produced from seamless copper tubing for high conductivity
- Tin-plated to resist corrosion

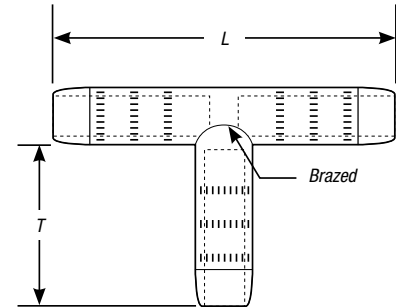

CAT. NO.	RUN	TAP	L	T	
TT 2-2	#2	#2	3 ¹ / ₁₆	1 ¹ / ₂	
TT 1/0-6	1/0	#6	3 ³ / ₁₆	1 ¹ / ₂	
TT 1/0-4		#4	3 ¹ / ₁₆	1 ¹ / ₂	
TT 1/0-2		#2	3 ³ / ₈	1 ¹ / ₂	
TT 1/0-1		#1	3 ¹ / ₁₆	1 ¹ / ₂	
TT 1/0-1/0		1/0	4	1 ¹ / ₂	
TT 2/0-6		2/0	#6	3 ²⁹ / ₃₂	1 ¹ / ₂
TT 2/0-4	#4		3 ³ / ₃₂	1 ¹ / ₂	
TT 2/0-2	#2		4 ¹ / ₃₂	1 ¹ / ₂	
TT 2/0-1	#1		4 ³ / ₃₂	1 ¹ / ₂	
TT 2/0-1/0	1/0		4 ⁵ / ₃₂	1 ¹ / ₂	
TT 2/0-2/0	2/0		4 ⁵ / ₃₂	1 ¹ / ₂	
TT 3/0-1/0	3/0	1/0	4 ⁷ / ₁₆	1 ³ / ₄	
TT 3/0-3/0		3/0	4 ⁷ / ₁₆	1 ³ / ₄	
TT 4/0-2	4/0	#2	4 ³ / ₁₆	1 ³ / ₄	
TT 4/0-1		#1	4 ³ / ₁₆	1 ³ / ₄	
TT 4/0-1/0		1/0	4 ¹ / ₄	1 ³ / ₄	
TT 4/0-2/0		2/0	4 ⁵ / ₁₆	1 ³ / ₄	
TT 4/0-4/0		4/0	4 ⁷ / ₁₆	1 ³ / ₄	
TT 250-2		250	#2	4 ¹ / ₄	1 ³ / ₄
TT 250-1	#1		4 ¹ / ₄	1 ³ / ₄	
TT 250-1/0	1/0		4 ⁵ / ₁₆	1 ³ / ₄	
TT 250-2/0	2/0		4 ³ / ₈	1 ³ / ₄	
TT 250-4/0	4/0		4 ¹ / ₂	1 ³ / ₄	
TT 250-250	250		4 ⁹ / ₁₆	1 ³ / ₄	
TT 300-300	300		300	4 ⁹ / ₁₆	1 ³ / ₄

Note: For other available sizes, please consult your Thomas & Betts representative.

CAT. NO.	RUN	TAP	L	T
TT 350-1/0	350	1/0	5 ³⁷ / ₆₄	2 ¹ / ₁₆
TT 350-2/0		2/0	5 ³⁷ / ₆₄	2 ¹ / ₁₆
TT 350-4/0		4/0	5 ²⁹ / ₃₂	2 ¹ / ₁₆
TT 350-350	350	350	5 ²⁹ / ₃₂	2 ¹ / ₁₆
TT 400-1/0	400	1/0	5 ²¹ / ₃₂	2 ³ / ₈
TT 400-2/0		2/0	5 ²¹ / ₃₂	2 ³ / ₈
TT 400-4/0		4/0	5 ²⁵ / ₃₂	2 ³ / ₈
TT 400-250		250	5 ²⁷ / ₃₂	2 ³ / ₈
TT 400-300		300	5 ²⁹ / ₃₂	2 ³ / ₈
TT 400-400		400	6 ¹ / ₃₂	2 ³ / ₈
TT 500-1/0	500	1/0	6 ²³ / ₆₄	2 ¹⁹ / ₃₂
TT 500-2/0		2/0	6 ²³ / ₆₄	2 ¹⁹ / ₃₂
TT 500-4/0		4/0	6 ¹⁵ / ₃₂	2 ¹⁹ / ₃₂
TT 500-250		250	6 ¹⁷ / ₃₂	2 ¹⁹ / ₃₂
TT 500-350		350	6 ²¹ / ₃₂	2 ¹⁹ / ₃₂
TT 500-400		400	6 ²³ / ₃₂	2 ¹⁹ / ₃₂
TT 500-500	500	6 ²³ / ₃₂	2 ¹⁹ / ₃₂	
TT 600-2/0	600	2/0	7 ³ / ₁₆	3 ³ / ₃₂
TT 600-4/0		4/0	7 ⁷ / ₁₆	3 ³ / ₃₂
TT 600-350		350	7 ⁷ / ₁₆	3 ³ / ₃₂
TT 600-500		500	7 ¹¹ / ₁₆	3 ³ / ₃₂
TT 600-600		600	7 ⁷ / ₈	3 ³ / ₃₂
TT 750-350		350	9 ¹ / ₂	4 ¹ / ₄
TT 750-500	750	500	9 ¹ / ₂	4 ¹ / ₄
TT 750-750		750	9 ¹ / ₂	4 ¹ / ₄
TT 1000-500	1000	500	9 ¹ / ₂	4 ¹ / ₄
TT 1000-1000		1000	9 ¹ / ₂	4 ¹ / ₄

Tees

Get permanent compression on the tap and be able to disconnect in the future.

Copper Tin-Plated Clamp Tee Connectors

- Constructed of cast copper and seamless copper tubing for high strength and high conductivity
- Tin plated to resist corrosion

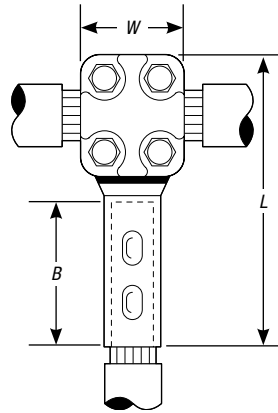

CAT. NO.	CONDUCTOR SIZE		B	L	W
	RUN	TAP			
2131-1	750	2/0 str.	1½	4¾	2¼
2131-2		4/0 str.	1¾	5	
2131-3		250	1¾	5	
2131-4		350	2	5¾	
2131-5		500	2¼	5¾	
2131-6		750	2¾	6¼	
2131-7	1000	2/0 str.	1½	4¾	
2131-8		4/0 str.	1¾	5	
2131-9		250	1¾	5	
2131-10		350	2	5¾	
2131-11		500	2¼	5¾	
2131-12		750	2¾	6¼	
2131-13	1500	1000	3	6¾	
2131-14		2/0 str.	1½	4¾	
2131-15		4/0 str.	1¾	5	
2131-16		250	1¾	5	
2131-17		350	2	5¾	
2131-18		500	2¼	5¾	
2131-19	750	2¾	6¼		
2131-20	1000	3	6¾		
2131-21	1500	3¾	6¾		
2131-22	2000	3¾	8	2½	

Tees

Ring bus and cable ring bus applications now have reliable connect and disconnect points.

Aluminum and Copper NEMA Lug Tee Taps for Cable Buses

- ANLTT Series for aluminum mains and NLTT Series for copper mains — choose the taps that match your system
- Multiple options available to accommodate all sizes of standard NEMA drilled compression lugs
- Tin plated to resist corrosion



NLTT 1000

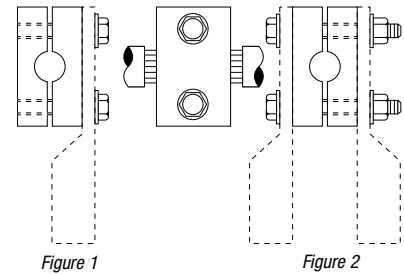

Tin-Plated Aluminum NEMA Lug Tee Taps

CAT. NO.	MAIN CONDUCTOR	FIGURE NUMBER/TAPS	WIDTH
ANLTT 4/0	4/0	2	1½
ANLTT 350	350		1½
ANLTT 500	500		1½
ANLTT 750	750		1¾
ANLTT 1000	1000		1¾
ANLTT 1500	1500		2½
ANLT 4/0	4/0	1	1½
ANLT 350	350		1½
ANLT 500	500		1½
ANLT 750	750		1¾
ANLT 1000	1000		1¾
ANLT 1500	1500		2½

Tin-Plated Copper NEMA Lug Tee Taps

CAT. NO.	MAIN CONDUCTOR	FIGURE NUMBER/TAPS	WIDTH
NLTT 4/0	4/0	2	1½
NLTT 350	350		1½
NLTT 500	500		1½
NLTT 750	750		1¾
NLTT 1000	1000		1¾
NLTT 1500	1500		2½
NLT 4/0	4/0	1	1½
NLT 350	350		1½
NLT 500	500		1½
NLT 750	750		1¾
NLT 1000	1000		1¾
NLT 1500	1500		2½

Note: For insulating covers, see [page F-378](#).
For sizes not listed, please consult your Thomas & Betts representative.