

GF contactors for DC switching

The new compact and efficient way to switch 1500 V DC for PV solar power plants

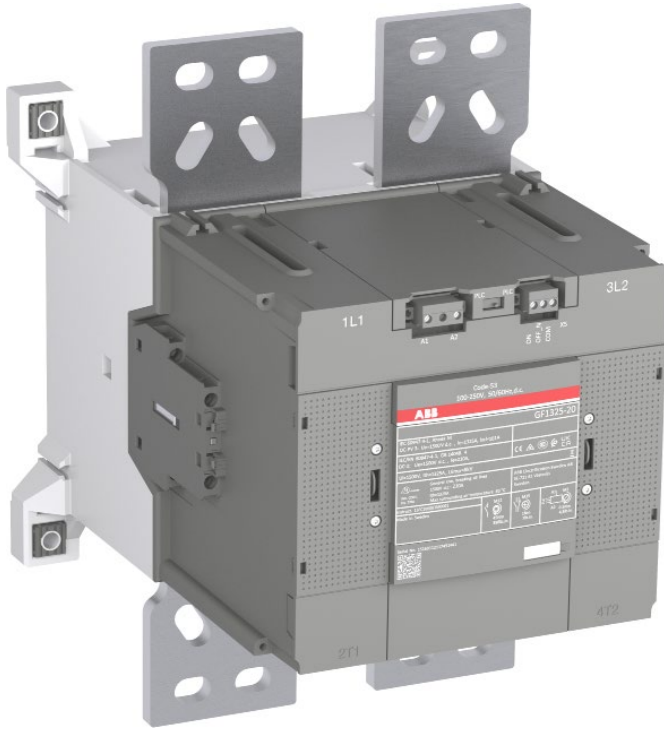

GF contactors for DC switching

The compact and efficient way of DC switching



The renewable energy industry is continuously striving towards increasing its efficiency in order to compete with traditional power sources. Photovoltaic (PV) solar power is one of the sources leading the way. In moving from 1000 V DC to 1500 V DC, costs of utility-scale power plants are greatly reduced.

The GF range of contactors expands ABB's current AF and GAF PV solar product offering by adding contactor switching capabilities for 1500 V DC.



Energy Efficiency

GF contactors offer tailored solutions to enable remote, automatic and energy efficient switching of 1500 V DC circuits in central PV inverter optimization. The GF contactors are built with ABB's standard low energy electronic coils for safe and controlled operation.



Continuous operation

The GF contactor features AF technology with continuous voltage and current control during the contactors operation. This ensures distinct, safe and energy efficient operations even in unstable networks. Voltage sags, dips or surges pose no threat. The GF contactor secures application uptime.



Speed up your projects

ABB's GF contactor complies with all major international standards. It features AC/DC controlled wide voltage range coils together with easily accessible coil terminals to make easier and quicker product selection and installation.

GF contactor range

The compact and efficient way of DC switching

Easy installation

GF contactors are designed for easy installation. Coil terminals and PLC control terminals are easily identified and accessed from the front of the contactor.

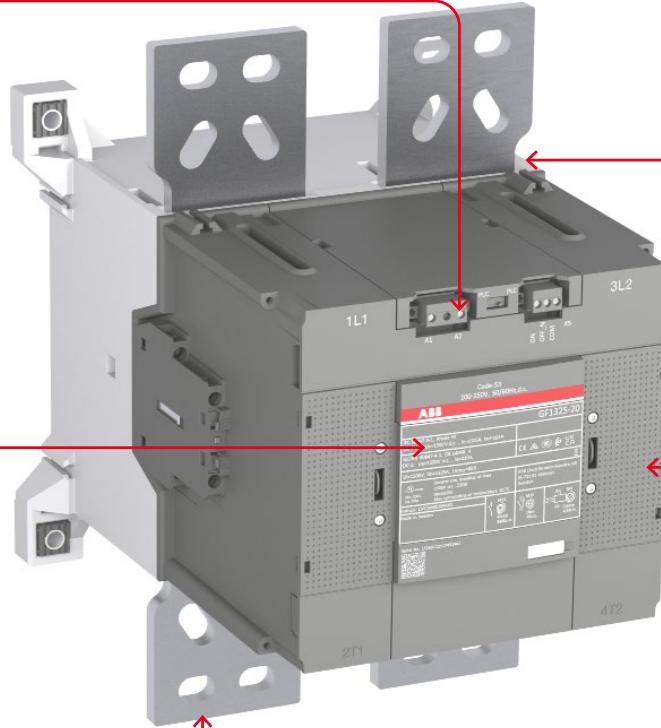

AF technology

GF contactors feature AF technology that ensures controlled, distinct and energy efficient operation of the contactor. Only two coils to cover 24 ... 60 V AC / DC and 100 ... 250 V AC / DC.

New IEC rating

DC-PV3 and DC-PV4 are two new contactor utilization categories introduced by IEC in 2018. Both are specifically tailored for PV solar applications. As a technical pioneer, ABB offers the GF contactor as the first ever DC-PV3 rated contactor.

Bidirectional design

The GF's two pole bidirectional design allows it to break both plus and minus, through the entire current range. Each pole is rated for 750 V DC.

Up to 1325 A 1500 V DC-PV3

The new GF range of DC contactors extends up to 1325 A for DC-PV3.

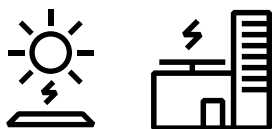

Switching DC in PV Plants

Contactors are typically selected for applications that need automatic remote control and switching. In a central PV inverter it can be necessary to switch the DC side in order to disconnect PV strings for output optimization. Grid codes sometime require a central PV inverter to be used for grid stabilization at night, this requires all PV panels to be disconnected on the DC side.



GF contactors allow remote and energy efficient switching in DC applications. By bringing contactor switching capabilities to 1500 V DC there are now additional options for PV inverter manufacturers to solve DC switching. Together with breakers and switch disconnects, ABB now have the most complete DC switching portfolio available for PV solar power.

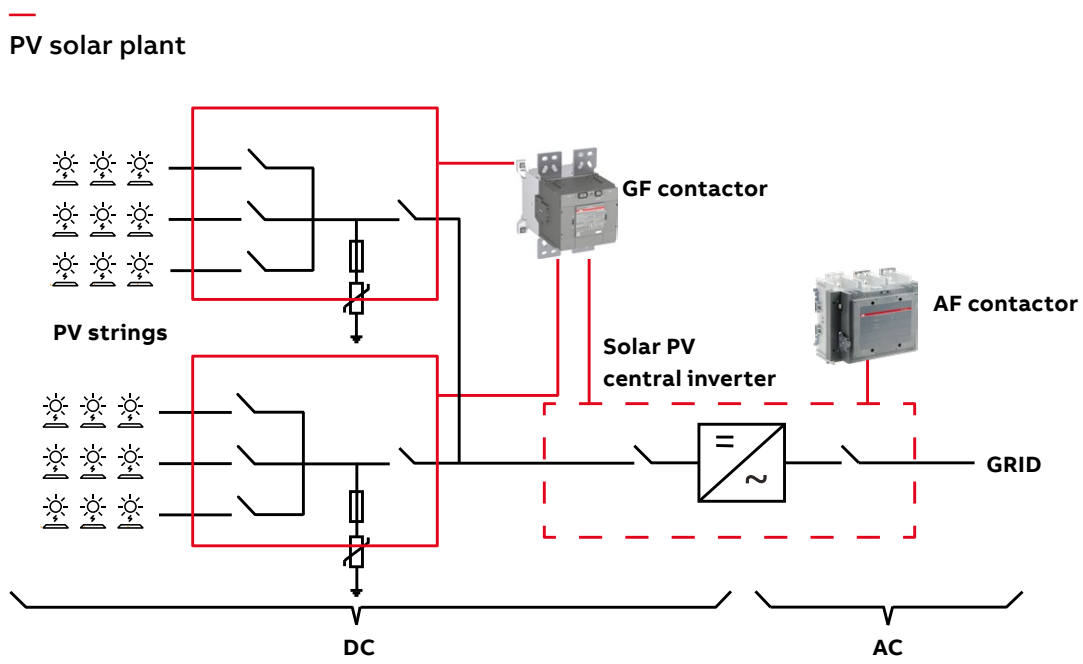

GF875 ... GF1325 contactors

875 to 1325 A DC-PV3

AC / DC operated with 2 N.O. + 2 N.C. auxiliary contacts

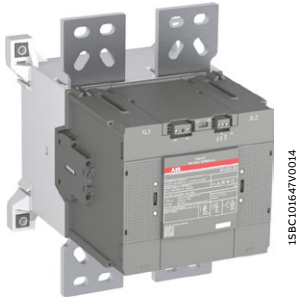

1SBC101647V0014

GF1325-20-22

GF875 ... GF1325 contactors are specifically designed for 1500 V DC PV solar central inverters. These contactors are of the block type design with 2 main poles. The main poles are fitted with special arcing contacts enabling bi-directional breaking of currents up to 750 V DC per pole.

- control circuit: AC or DC operated with electronic coil interface accepting a wide control voltage range (e.g. 100...250 V DC), only 2 coils to cover control voltages between 24 ... 60 V AC / DC and 100 ... 250 V AC / DC.
 - can manage large control voltage variations
 - reduced panel energy consumption
 - very distinct closing and opening
 - can withstand short voltage dips and voltage sags.
- built-in surge suppression

IEC	UL/CSA	Rated control circuit voltage U _c		Auxiliary contacts fitted	Type	Order code	Weight
		V 50/60 Hz	V DC				
Rated operational current □ ≤ 40 °C 1500 V DC-PV3 A	General use rating □ ≤ 40 °C 1500 V DC A						Pkg (1 pce) kg
875	210	24...60	24...60	2 2	GF875-20-22-51	1SFL617731R5122	14.3
		100...250	100...250	2 2	GF875-20-22-53	1SFL617731R5322	14.3
1050	210	24...60	24...60	2 2	GF1050-20-22-51	1SFL637731R5122	14.3
		100...250	100...250	2 2	GF1050-20-22-53	1SFL637731R5322	14.3
1325	210	24...60	24...60	2 2	GF1325-20-22-51	1SFL647731R5122	14.3
		100...250	100...250	2 2	GF1325-20-22-53	1SFL647731R5322	14.3

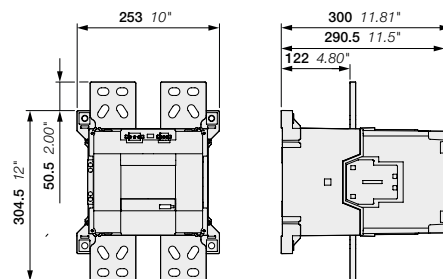

GF875, GF1050, GF1325

Main dimensions mm, inches

GF875 ... GF1325 contactors

Technical data

Main pole - Utilization characteristics according to IEC

Contactors types	AC / DC operated	GF875	GF1050	GF1325
Standards		IEC 60947-1 / 60947-4-1 and EN 60947-1 / 60947-4-1		
Rated operational voltage U _e max.		1500 V DC		
Conventional free-air thermal current I _{th} acc. to IEC 60947-4-1				
For air temperature close to contactor	$\theta \leq 60\text{ °C}$	875 A	1050 A	1325 A
	$\theta \leq 70\text{ °C}$	650 A	850 A	1050 A
With conductor cross-sectional area		600 mm ²	800 mm ²	1000 mm ²
DC-PV3 Utilization category for air temperature close to contactor U _e max. ≤ 1500				
	I _{sc1}	210 A	210 A	101 A
	$\theta \leq 60\text{ °C}$	875 A	1050 A	1325 A
	$\theta \leq 70\text{ °C}$	650 A	850 A	1050 A
DC-PV4 Utilization category for air temperature close to contactor U _e max. ≤ 1500				
	I _{sc1}	210 A	210 A	101 A
	$\theta \leq 60\text{ °C}$	325 A	390 A	490 A
Maximum electrical switching frequency		15 cycles/h		

Main pole - Utilization characteristics according to UL / CSA

Contactors types	AC / DC operated	GF875	GF1050	GF1325
Standards		UL 60947-4-1		
Thermal current I _{th}		875 A	1050 A	1325 A
DC general use acc. to UL60947-4-1, U _e max. ≤ 1500		210 A	210 A	210 A

General technical data

Contactors types	AC / DC operated	GF875	GF1050	GF1325
Rated insulation voltage U _i acc. to IEC 60947-4-1		1500 V		
acc. to UL 60947-4-1		1500 V		
Rated impulse withstand voltage U _{imp} .				
Main contacts		8 kV		
Coil terminal		4 kV		
Ambient air temperature close to contactor				
Operation		-40 to +70 °C		
Storage		-40 to +70 °C		
Climatic withstand		acc. to IEC 60068-2-30		
Maximum operating altitude (without derating)		2000 m		
Rated short-time withstand current I _{cw} at 40 °C ambient temp. in free air from a cold state (1)				
	1 s	6218 A	7600 A	9500 A
	10 s	5184 A	6336 A	7920 A
	30 s	4150 A	5207 A	6340 A
	1 min	3109 A	3800 A	4750 A
	15 min	1139 A	1392 A	1740 A
Mechanical durability				
Number of operating cycles		50 000		
Max. switching frequency		15 cycles/h		

(1) Ratings are stated in DC.

GF875 ... GF1325 contactors

Technical data

Magnet system characteristics

Contactor types	AC / DC operated	GF875	GF1050	GF1325
Coil operating limits acc. to IEC 60947-4-1	AC or DC supply	At $\bar{\bar{\tau}} \leq 70^\circ\text{C}$ $0.85 \times U_c \text{ min} \dots 1.1 \times U_c \text{ max}$.		
Rated control circuit voltage U_c Coil Consumption				
AC control voltage				
24...60 V AC 50/60Hz	Max. pull-in value	885 VA		
	Max. holding value	11 VA		
100...250 V AC 50/60Hz	Max. pull-in value	1300 VA		
	Max. holding value	11 VA		
DC control voltage				
24...60 V DC	Max. pull-in value	560 W		
	Max. holding value	12 W		
100...250 V DC	Max. pull-in value	1050 W		
	Max. holding value	3.5 W		
Drop-out voltage		55 % of $U_c \text{ min}$.		
Dips withstand $-20^\circ\text{C} \leq \bar{\bar{\tau}} \leq +60^\circ\text{C}$		20 ms		
Operating time				
Coil supply between A1 - A2				
Between coil energization and:	Main contact opening	50...120 ms		
Between coil de-energization and:	Main contact closing	33...70 ms		
Control input for PLC's				
Between coil energization and:	Main contact closing	40...90 ms		
Between coil de-energization and:	Main contact opening	10...30 ms		

Mounting characteristics and conditions for use

Contactor types	AC / DC operated	GF875	GF1050	GF1325
Mounting positions				
Control voltage / Ambient temperature				
Mounting positions	1, $1 \pm 30^\circ$, 2, 3, 4, 5 at $\bar{\bar{\tau}} \leq 70^\circ\text{C}$	0.85 x $U_c \text{ min} \dots 1.1 \times U_c \text{ max}$.		
	6	Unauthorized		
Fixing by screws		4 x M5		

GF875 ... GF1325 contactors

Technical data

Connecting characteristics

Contactor types	AC / DC operated	GF875	GF1050	GF1325
Main terminals Flat type				
Connection capacity (min. ... max.)				
Main conductors (poles)				
Bars or lugs	$L \leq$	100 mm		
	$\varnothing >$	12 mm		
Connection capacity acc. to UL/CSA	1 or 2 x	busbars only		
Tightening torque	Recommended	45 Nm / 398 lb.in		
	Max.	49 Nm		
Auxiliary conductors				
Rigid solid	1 x	1...4 mm ² (coil terminals : 2.5 mm ²)		
	2 x	1...4 mm ² (coil terminals : 1.5 mm ²)		
Flexible with ferrule	1 x	0.75...2.5 mm ²		
	2 x	0.75...2.5 mm ²		
Lugs	$L \leq$	8 mm		
	$l >$	3.7 mm		
Connection capacity acc. to UL/CSA	1 or 2 x	AWG 18...14		
Tightening torque	Recommended	1.00 Nm / 9 lb.in		
	Max.	1.20 Nm		
Degree of protection acc. to IEC 60947-1 / EN 60947-1 and IEC 60529 / EN 60529				
Main terminals		IP00		
Coil terminals		IP00		
Screw terminals				
Main terminals		M12		
		Screws and bolts		
Coil terminals (delivered in open position)		M3.5		
	Screwdriver type	Flat \varnothing 5.5 mm / Pozidriv 2		

Accessories

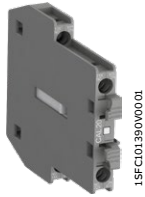

CAL20-11

The auxiliary contact blocks are used for the operation of auxiliary circuits and control circuits for standard industrial environments.

Types of auxiliary contact blocks for side mounting:

- CAL 2-pole block, with instantaneous N.O. + N.C. contacts.

For clipping onto the right- and/or left-hand side of the contactors.

The CAL20-11B is a second block for mounting in addition to a first CAL20-11 block, right- and/or left-hand of the GF875 ... GF1325 contactors.

The auxiliary contact blocks are equipped with screw type connecting terminals delivered open, protected against accidental direct contact and bear the corresponding function marking.

For contactors	Auxiliary contacts	Type	Order code	Pkg qty	Weight (1 pce)
					kg

Side-mounted instantaneous auxiliary contact blocks

GF875, GF1050, GF1325	1 1	CAL20-11	1SFN010920R1011	1	0.040
	1 1	CAL20-11B	1SFN010920R3011	1	0.040

Auxiliary contact blocks for GF875 ... GF1325 contactors







Technical data

Type	CAL20	
Contact utilization characteristics according to IEC		
Standards	IEC 60947-5-1 and EN 60947-5-1	
Rated insulation voltage U_i acc. to IEC 60947-5-1	690 V	
Rated impulse withstand voltage U_{imp} .	6 kV	
Rated operational voltage U_e max.	24...690 V AC	
Conventional thermal current I_{th} - $\vartheta \leq 40$ °C	16 A	
Rated frequency (without derating)	50/60 Hz	
I_e / Rated operational current AC-15 acc. to IEC 60947-5-1	24-127 V 50/60 Hz	6 A
	220-240 V 50/60 Hz	4 A
	380-440 V 50/60 Hz	3 A
	500-690 V 50/60 Hz	2 A
Making capacity acc. to IEC 60947-5-1	10 x I_e AC-15	
Breaking capacity acc. to IEC 60947-5-1	10 x I_e AC-15	
I_e / Rated operational current DC-13 acc. to IEC 60947-5-1	24 V DC	3 A / 72 W
	48 V DC	1.5 A / 72 W
	72 V DC	1 A / 72 W
	110 V DC	0.55 A / 60 W
	125 V DC	0.55 A / 69 W
	220 V DC	0.3 A / 69 W
	250 V DC	0.3 A / 75 W
Short-circuit protection device gG type fuse	10 A	
Rated short-time withstand current I_{cw} $\vartheta = 40$ °C	for 1.0 s	100 A
	for 0.1 s	140 A
Minimum switching capacity with failure rate acc. to IEC 60947-5-4	24 V / 50 mA	
Power dissipation per pole at 6 A	≤ 10 -6	
Mechanical durability	0.15 W	
Number of operating cycles	3 millions	
Max. switching frequency	300 cycles/h	
Max. electrical switching frequency	AC-15	300 cycles/h
	DC-13	300 cycles/h

Contact utilization characteristics according to UL / CSA

Standards	UL 508, CSA C22.2 N°14
Max. operational voltage	600 V AC, 250 V DC
Pilot duty	A600, Q300
AC thermal rated current	10 A
AC maximum volt-ampere making	7200 VA
AC maximum volt-ampere breaking	720 VA
DC thermal rated current	2.5 A
DC maximum volt-ampere making-breaking	69 VA

Connecting characteristics

Connection capacity (min. ... max.)		
	Solid / stranded	1 x 1...4 mm ²
		2 x 1...4 mm ²
	Flexible with non insulated ferrule	1 x 0.75...2.5 mm ²
		2 x 0.75...2.5 mm ²
	Flexible with insulated ferrule	1 x 0.75...2.5 mm ²
		2 x 0.75...2.5 mm ²
	Lugs	L \leq 8 mm
		L $>$ 3.7 mm
Connection capacity acc. to UL/CSA	1 or 2 x	AWG18...14
Stripping length	9 mm	
Tightening torque	1 Nm	
Degree of protection acc. to IEC 60947-1 / EN 60947-1 and IEC 60529 / EN 60529	IP20	
Screw terminals	Delivered in open position, screws of unused terminals must be tightened	
All terminals	M3.5	
Screwdriver type	Flat \varnothing 5.5 / Pozidriv 2	



—

ABB AB

Electrification Business

Low Voltage Products and Systems

Protection & Connection

SE-721 61 Västerås / Sweden

**You can find the address of your local sales organization
on the ABB home page**



<http://www.abb.com/lowvoltage>



We reserve the right to make technical changes or modify the contents of this document without prior notice. ABB does not accept any responsibility whatsoever for potential errors or possible lack of information in this document.

We reserve all rights in this document and in the subject matter and illustrations contained therein. Any reproduction, disclosure to third parties or utilization of its contents – in whole or in parts – is forbidden without prior written consent of ABB.

Copyright© 2020 ABB - All rights reserved