

San Ace 120AD

ACDC Fan

9AD type

Features

High Static Pressure and High Airflow

This fan delivers a maximum static pressure of 62 Pa and a maximum airflow of 2.35 m³/min.⁽¹⁾

Long Life

The expected life has increased by 2.4 times compared with our current model.⁽²⁾

Wide Operating Voltage Range

This fan has an input voltage range of 100 to 240 VAC, supporting both 100 and 200 VAC systems.

Low Noise and Energy Saving

The PWM control enables the control of fan speed, contributing to lowering noise and improving energy efficiency of equipment.

(1) For models 9AD1201P4H001 and 9AD1201H4002

(2) Current model: 120 x 120 x 25 mm *San Ace 120 AC Fan* (model: 109S085) at a frequency of 60 Hz.



120 x 120 x 25 mm

Specifications

The models listed below **have ribs and pulse sensors with PWM control function**. For models without ribs, append "1" to the end of model numbers.

Model no.	Rated voltage [V]	Operating voltage range [V]	Frequency [Hz]	PWM duty cycle* [%]	Rated current [A]	Rated input [W]	Rated speed [min ⁻¹]	Max. airflow [m ³ /min] [CFM]	Max. static pressure [Pa] [inchH ₂ O]	SPL [dB(A)]	Operating temperature [°C]	Expected life [h]
9AD1201P4H001	100 to 240	90 to 264	50/60	100	0.06	3.4	3000	2.35 83	62 0.249	40	-20 to +70	60000/60°C (90000/40°C)
				30	0.02	0.7	900	0.7 24.7	6.6 0.03	14		

* PWM frequency is 25 kHz. Models without ratings for 0% PWM duty cycle have zero speed at 0%. When control terminal is open, speed is the same as at 0% duty cycle.

The models listed below **have ribs and no sensors**. For models without ribs, append "1" to the end of model numbers.

Model no.	Rated voltage [V]	Operating voltage range [V]	Frequency [Hz]	Rated current [A]	Rated input [W]	Rated speed [min ⁻¹]	Max. airflow [m ³ /min] [CFM]	Max. static pressure [Pa] [inchH ₂ O]	SPL [dB(A)]	Operating temperature [°C]	Expected life [h]
9AD1201H4002	100 to 240	90 to 264	50/60	0.06	3.4	3000	2.35 83	62 0.249	40	-20 to +70	60000/60°C (90000/40°C)
9AD1201M4002				0.04	1.6	2250	1.76 62	35 0.140	34		
9AD1201L4002				0.03	1.1	1800	1.41 49	22 0.088	26		

Note: Models with the following sensor specifications are also available as options: **Low-speed sensor**

Common Specifications

- Material Frame: Plastic (Flammability: UL 94V-0), Impeller: Plastic (Flammability: UL 94V-0)
- Expected life Refer to specifications
(L10 life: 90% survival rate for continuous operation in free air at 60°C, rated voltage)
Expected life at 40°C is for reference only.
- Motor protection function Locked rotor burnout protection
- Dielectric strength 50/60 Hz, 2500 VAC, for 1 second (between lead wire conductors and frame)
50/60 Hz, 1500 VAC, for 1 minute (between input lead wire (L,N) conductors and other lead wire conductors)
- Insulation resistance 10 MΩ min. at 500 VDC
(between lead wire conductors and frame, between input lead wire (L,N) conductors and other lead wire conductors)
- Sound pressure level (SPL) A-weighted sound pressure level (SPL) at 1 m away from the air inlet.
- Operating temperature Refer to specifications (Non-condensing)
- Storage temperature -30 to +70°C (Non-condensing)
- Lead wire **AC power input** L: Orange N: Gray
Sensor Yellow **Control** Brown **GND** Black
(For models without sensors, there is no sensor or control wiring.)
- Mass 180 g

Note 1: Take safety measures not to touch this product (including lead wires) while the power is on.

Note 2: Please ensure appropriate insulation within the final product because of functional insulation between input leads wire (L,N) and other lead wire conductors.

Airflow - Static Pressure Characteristics

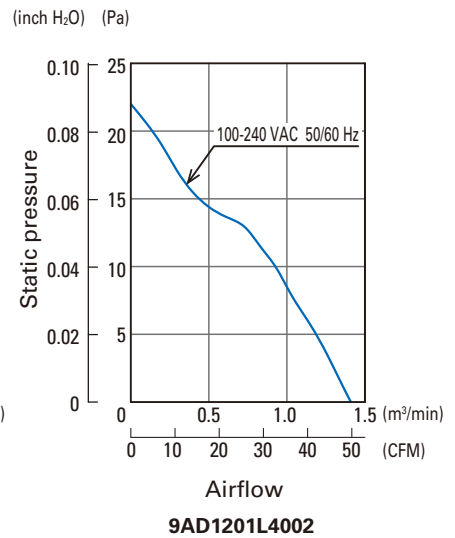
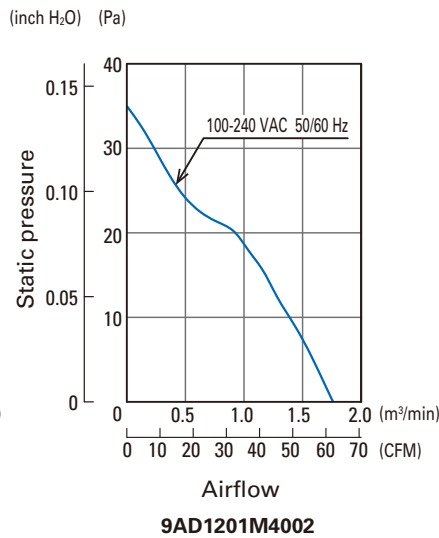
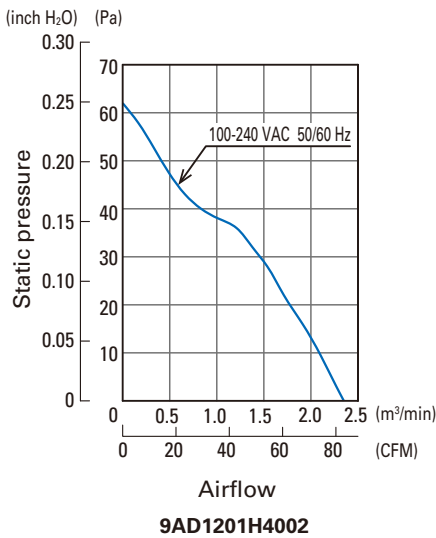
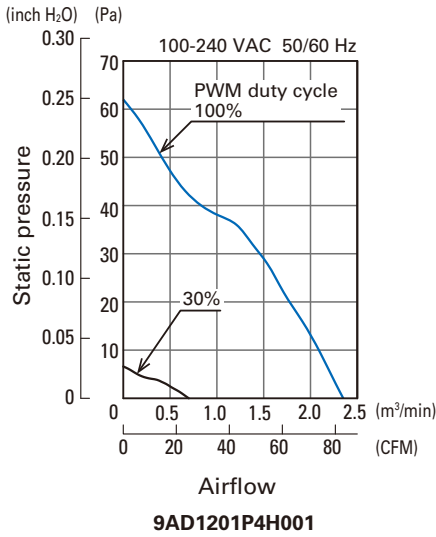

PWM Duty - Speed Characteristics Example

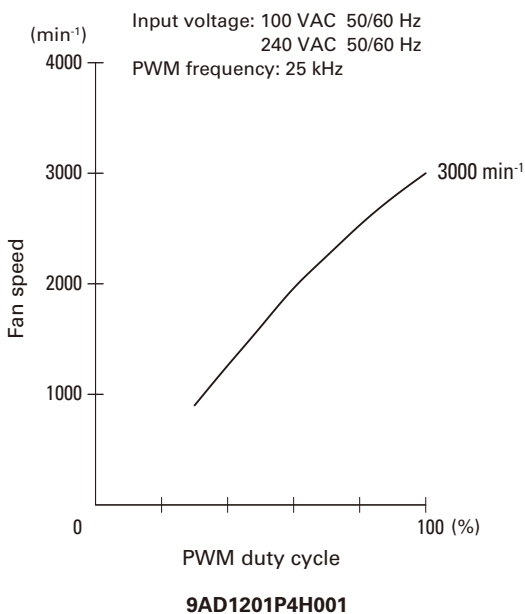

PWM Input Signal Example

Input signal waveform

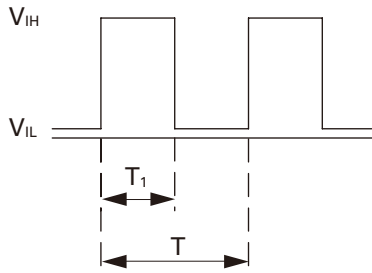

$V_{IH} = 4.75 \text{ to } 5.25 \text{ V}$ $V_{IL} = 0 \text{ to } 0.4 \text{ V}$
 PWM duty cycle (%) = $\frac{T_1}{T} \times 100$ PWM frequency 25 (kHz) = $\frac{1}{T}$
 Current source (I_{source}) = 1.0 mA max. (when control voltage is 0 V)
 Current sink (I_{sink}) = 10 mA max. (when control voltage is 5.25 V)

When the PWM control terminal is open, the fan speed is the same as the speed at 0% PWM duty cycle.

Example of Connection Schematic

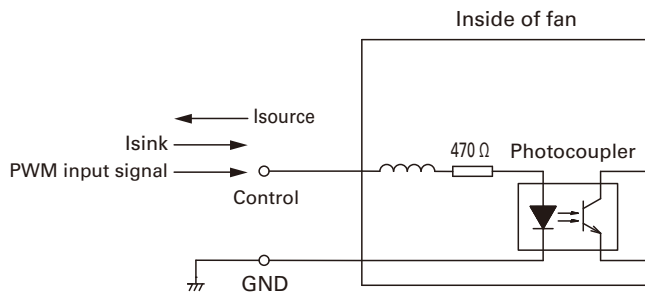

Specifications for Pulse Sensors

Output circuit: Open collector

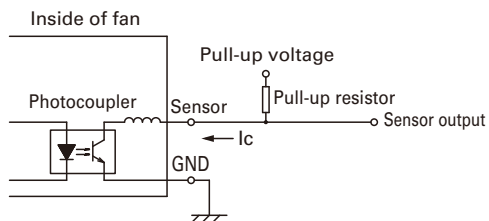

$V_{CE} = +60 \text{ V max.}$
 $I_c = 10 \text{ mA max. [} V_{OL} = V_{CE} \text{ (SAT)} = 1.2 \text{ V max.]}$

Output waveform (Need pull-up resistor)

In case of steady running

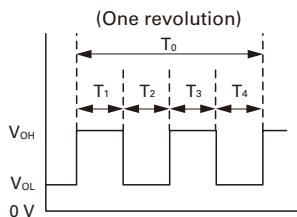

$T_{1 \text{ to } 4} \doteq (1/4) T_0$
 $T_{1 \text{ to } 4} \doteq (1/4) T_0 = 60/4N \text{ (s)}$
 $N = \text{Fan speed (min}^{-1}\text{)}$

Dimensions (unit: mm) (Ribbed frame with pulse sensor with PWM control function)

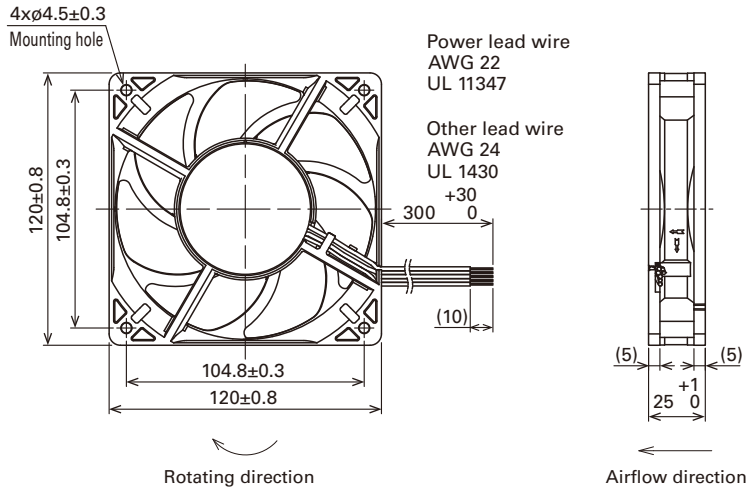

Reference Dimensions of Mounting Holes and Vent Opening (unit: mm)

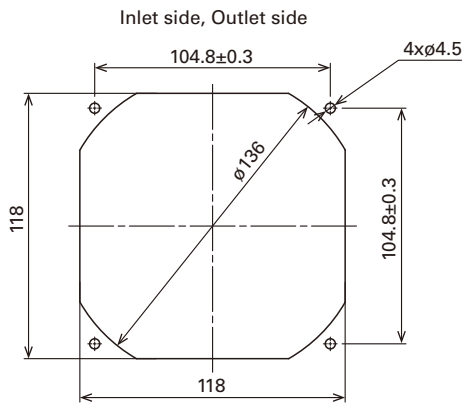

Options

Finger guards

Model no.: 109-019E, 109-019K

Resin finger guards

Model no.: 109-1000G

Resin filter kits

Model no.: 109-1000F13 (13PPI), 109-1000F20 (20PPI)
109-1000F30 (30PPI), 109-1000F40 (40PPI)

Notice

- Please read the "Safety Precautions" on our website before using the product.
- The products shown in this catalog are subject to Japanese Export Control Law. Diversion contrary to the law of exporting country is prohibited.
- For protecting fan bearings against electrolytic corrosion near strong electromagnetic noise sources, we provide effective countermeasures such as Electrolytic Corrosion Proof Fans and EMC guards. Contact us for details.

SANYO DENKI CO., LTD. 3-33-1 Minami-Otsuka, Toshima-ku, Tokyo 170-8451, Japan TEL: +81 3 5927 1020

<https://www.sanyodenki.com/>

The names of companies and/or their products specified in this catalog are the trade names, and/or trademarks and/or registered trademarks of such respective companies. San Ace, SANUPS, and SANMOTION are trademarks of SANYO DENKI CO., LTD.

Specifications are subject to change without notice.

CATALOG No. C1140B002 '24.2