

Hitachi Electromagnetic Contactors & Switches (up to 660 VAC)







ELECTROMAGNETIC CONTACTORS AND SWITCHES

CONTENTS

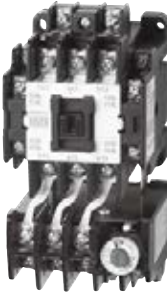

ELECTROMAGNETIC CONTACTORS AND SWITCHES	4
1. TYPES AND MODEL ARRANGEMENTS OF ELECTROMAGNETIC CONTACTORS AND SWITCHES	4
2. FEATURES OF NEW ELECTROMAGNETIC CONTACTORS AND SWITCHES (HS series).	5
3. FEATURES OF STANDARD TYPE ELECTROMAGNETIC CONTACTORS AND SWITCHES (H series).	7
4. RATINGS AND SPECIFICATIONS	10
4-1 Standard Models	10
4-2 Thermal Overload Relays	12
4-3 Electromagnetic Switches with 2E Thermal Overload Relay	14
4-4 DC Operated Electromagnetic Contactors	16
4-5 Latched Electromagnetic Contactors	18
4-6 Contactor Relays	20
5. STANDARD TYPE ELECTROMAGNETIC CONTACTORS AND SWITCHES	22
5-1 Coil Specifications.	22
5-2 Performance	22
5-3 Application for the International Standards	22
5-4 Normal Service Conditions	22
5-5 Selection	23
5-6 Cautions	27
5-7 Appearance and Dimensions	28
6. THERMAL OVERLOAD RELAYS	37
6-1 Construction	37
6-2 Tripping Characteristics	38
6-3 Application	39
6-4 Appearance and Dimensions	41
7. ELECTROMAGNETIC SWITCHES WITH 2E THERMAL OVERLOAD RELAY (OVERLOAD AND PHASE-FAILURE PROTECTION).	43
7-1 Phase-Failure Protection Effect of 2E Thermal Overload Relays	43
7-2 Appearance and Dimensions	43
8. DC OPERATED ELECTROMAGNETIC CONTACTORS	44
8-1 Operating Principle of Double Coil	44
8-2 Dimensions	44
9. LATCHED ELECTROMAGNETIC CONTACTORS.	45
9-1 Explanation of Operation	45
9-2 Dimensions	45
10. AUTOMATIC STAR-DELTA STARTERS (3-CONTACTORS TYPE)	47
10-1 Ratings and Specifications	47
10-2 Connection Diagram	48
10-3 Dimensions	48
11. CONTACTOR RELAYS	49
11-1 Application for the International Standards	49
11-2 Coil Ratings	49
11-3 Contact Arrangement Diagram	50
11-4 Dimensions and Mass.	50
12. OPTIONS	51
12-1 Aux. Contact Block, Safety Cover and Mechanical Interlock Unit	51
12-2 Coil Surge Absorber	52
13. OLD PRODUCTS (BACKLOG)	53
14. MAINTENANCE	56
K-TYPE MANUAL SWITCHES	58
PUSH BUTTONS (FOR OPERATING OF MAGNETIC CONTACTORS AND SWITCHES)	59

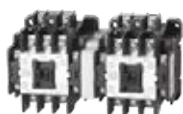
ELECTROMAGNETIC CONTACTORS AND SWITCHES

1. TYPES AND MODEL ARRANGEMENTS OF ELECTROMAGNETIC CONTACTORS AND SWITCHES

	Electromagnetic Contactors		Electromagnetic Switches			
			Without Enclosure		With Enclosure	
Non-reversible Type		HS □ □ 8-50 frame		HS □ □ -T 8-50 frame		SHS □ □ -T 10-50 frame
		H □ □ 65C-800C frame		H □ □ -T 65C-600C frame		SH □ □ -T 65C-600C frame
Reversible Type 20-800C frame (:provided mechanical interlock)		HS □ □ -R 10-50 frame		HS □ □ -RT 10-50 frame		SHS □ □ -RT 10-50 frame
		H □ □ -R 65C-800C frame		H □ □ -RT 65C-600C frame		SH □ □ -RT 65C-600C frame

Contactor Relays

XS4 	X □ □  3-8 contacts (5 types)
---	---

Thermal Overload Relays

 12-600A (9 types)	TR □ □ - □ □ (Electromagnetic Switches with Thermal Overload Relay H □ □ -T H □ □ -TK with 2E Thermal Overload Relay)
---	---

DC Operated Electromagnetic Contactors

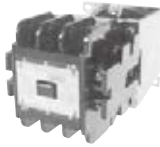
 10-800C frame	H □ □ -G
--	-----------------

Latched Electromagnetic Contactors

 10-600C frame	H □ □ -L
--	-----------------

Heavy Load Electromagnetic Contactors

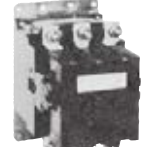
 10-200N frame	H □ □ -H
--	-----------------

HS series – New ELECTROMAGNETIC CONTACTORS AND SWITCHES

2. FEATURES OF NEW ELECTROMAGNETIC CONTACTORS AND SWITCHES (HS series)

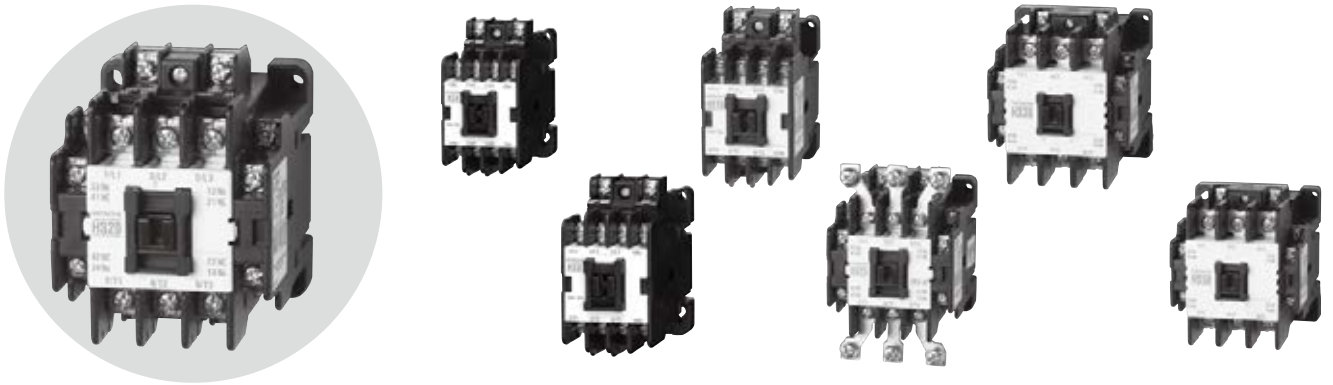

ELECTROMAGNET RESISTANT TO VOLTAGE FLUCTUATIONS

The contactor maintains stable conducting performance even when the power supply voltage drops when started under load.

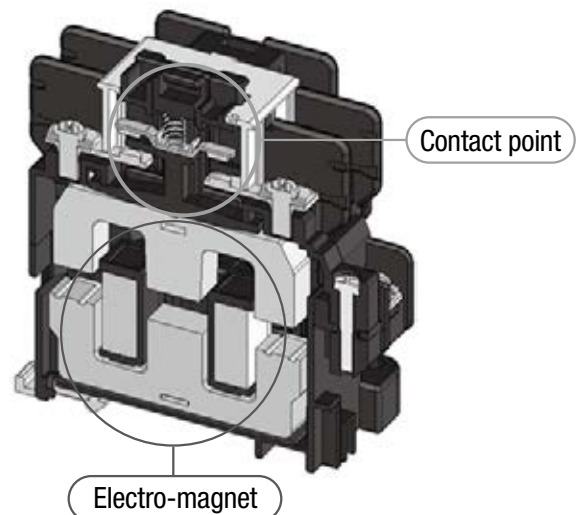
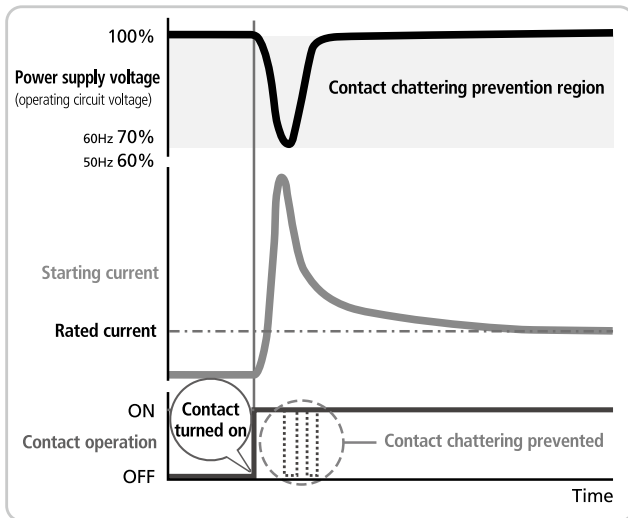

New shock-absorbing structure

Immediately before collision, the movable core and the fixed core move in the same direction to absorb the shock.

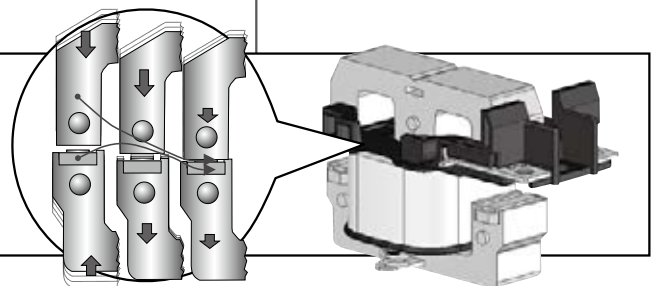

Stable operation

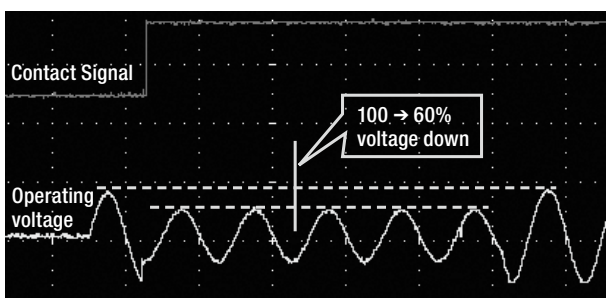

During contact chattering

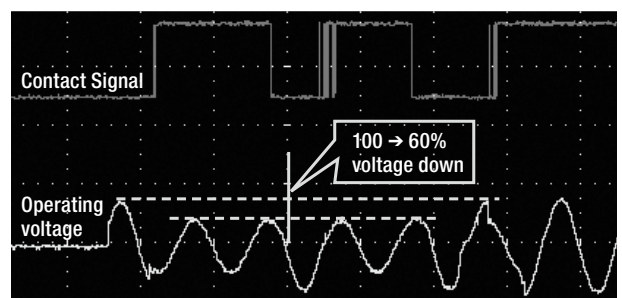

IMPROVED ENVIRONMENTAL PERFORMANCE

Reduced power consumption

The HS series reduces power consumption by operating coils with 20A to 50A frames.

Frame	20A	25A	35A	50A
Power consumption	86%	86%	95%	95%

(compared with conventional Hitachi IES products)

Amount of materials used reduced, recyclable materials increased

The HS series improves environmental performance through miniaturization to reduce product weight and with indications of material names for easier recycling.



Example of indication for resin used

IMPROVED USABILITY by Miniaturization and an Enhanced Auxiliary Contact Unit

15% height reduction

Improved magnet and contact efficiency greatly decreases the height from the mounting surface for 20A to 50A frames.

Improved inching performance

The capability of the 10A frame has been upgraded to 2.2 kW and that of the 20A frame to 3.7 kW.

220VAC, 50% inching rate 50%, 100,000-operation service life (AC-4)

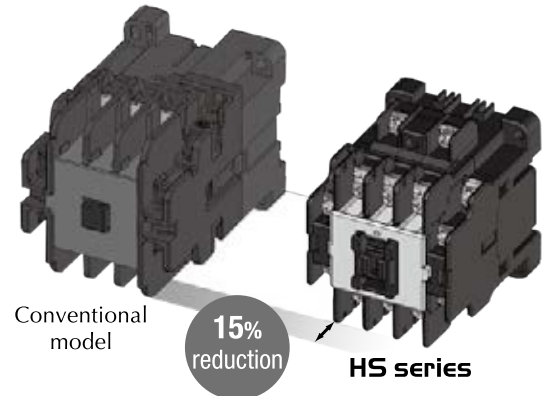
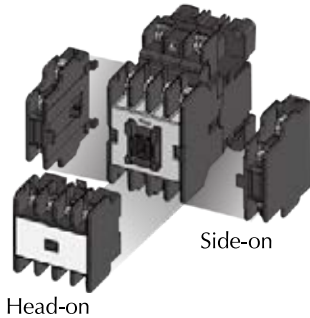

Enhanced auxiliary contact unit

In addition to the side-on type, a head-on type is available, further improving usability.

You can easily mount the side-on type with one hand (patent pending).

IMPROVED RELIABILITY AND SAFETY

Minimum load to 20V 5mA on the auxiliary contact

The HS series uses a highly reliable twin contact to open or close the contact of a micro load circuit.

Mechanical durability of 8 million operations

The HS series uses a new shock absorbing structure to improve durability.

Safe contact opening

(the auxiliary b-contact is turned off during welding of the main contact)

The HS series complies with the requirements for control functions for failures specified in EN60204 for electrical equipment of industrial machinery.

Fireproof materials used

Resin-molded parts use UL-approved fireproof materials to help improve system reliability.

Protective cover (option)

You can opt for a protective cover applicable to the IP20.

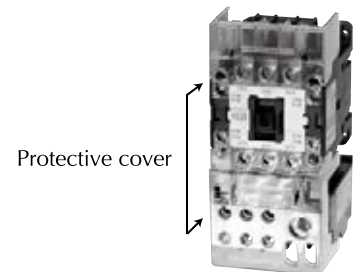

COMPLIES WITH VARIOUS INTERNATIONAL STANDARDS

The HS series either complies with or expects to comply with various domestic and international standards.

JIS	IEC	VDE	EN	CE	TÜV	UL-CSA	CCC
Compliant					Awaiting certification		

H series – STANDARD TYPE ELECTROMAGNETIC CONTACTORS AND SWITCHES

3. FEATURES OF STANDARD TYPE ELECTROMAGNETIC CONTACTORS AND SWITCHES (H series)

C-SERIES LINE-UP (65A TO 800A FRAME)

- **International standards approval.**
Conforms to IEC 60947-4-1, BS, DIN and VDE standards (H65C to H800C). Adapt to CE-Marking (H65C to H125C).
- **Applicable to use for crane and hoist due to shortened breaking time of contactors.**

EASILY CERTAIN THE OPERATION BY COLOR INDICATOR

Color-indicators enable certain discrimination of moving.

Contactors

Color of indicator changes from green to red after the contactor is closed (H65C to H800C).

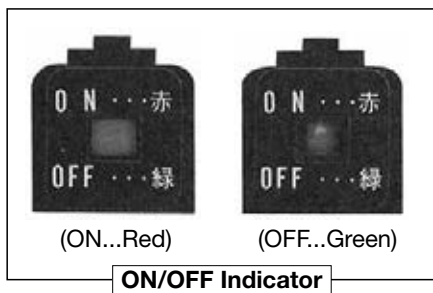

Thermal overload relays

Color of indicator changes from black to yellow if the thermal overload relay was tripped (All models).

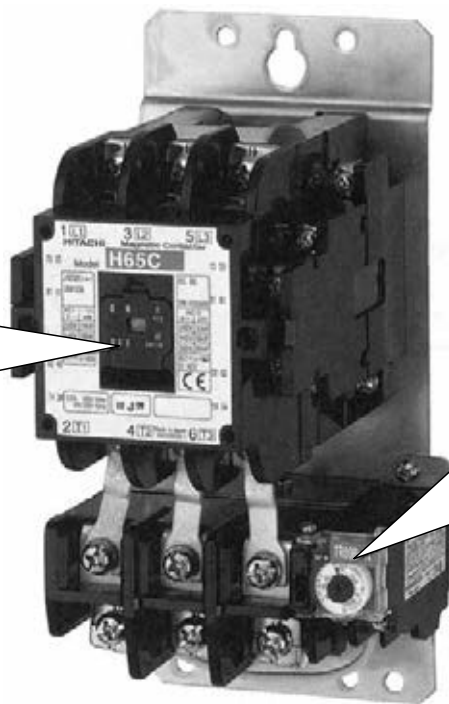
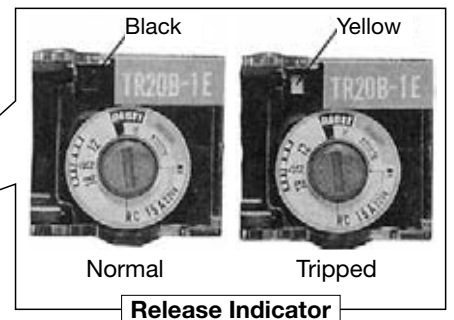

NOISELESS ELECTRO-MAGNET COIL

Electromats excited on DC will not permit buzzing (H150C to H800C).



Stop buzzing

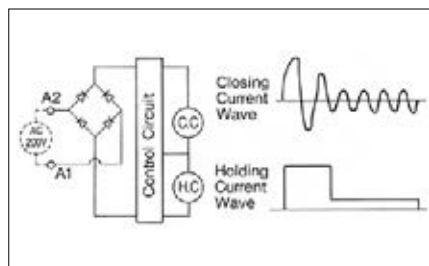

Built-in coil surge absorber

Built-in coil surge absorber prevents generation of surge voltage.

Voltage drop

Even if the operating voltage suddenly drops 65% of the rated voltage of contactors, contactors certainly keep on position without chattering.

HIGH SAFETY

Preventive mechanism for mal-operation, phase separator, etc.

■ Preventive mechanism of careless operation

● Contactors
Sequence check rod will be operated when the indicator is opened (H65C to H800C).

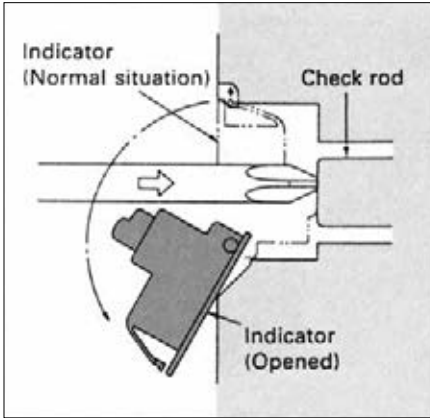

● Thermal overload relays “Cover” prevents the touch to release test lever (All models).

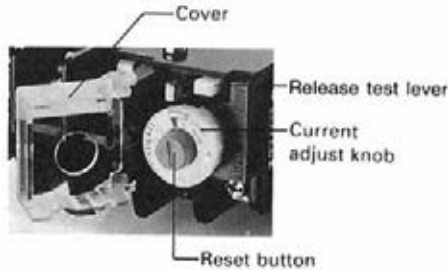

■ Free arc space

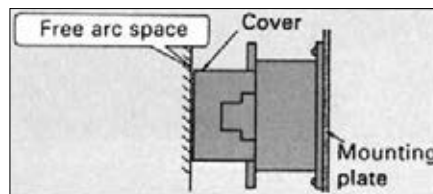

■ Phase separator

Additional phase separator (H80C to H800C).
Phase separators will be attached to the contactor.

■ Mechanical interlock

(Reversible type: over H65C)
Mechanical interlock is also attached to reversible contactor.

■ Safety cover (option)

Easy attachment (H65C to H800C).
Live parts will be covered by safety cover, and it improves safety.

HIGH RELIABILITY

Highly reliable contacts enable direct connection to the electronic circuits.

■ Auxiliary contacts of contactors

Rolling twin contacts assure high contact reliability (All models).

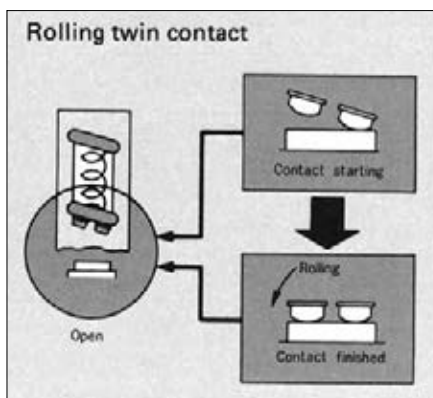

■ Signal contacts of thermal overload relays

Signal contacts of thermal overload relays are 1NO 1NC (All models).

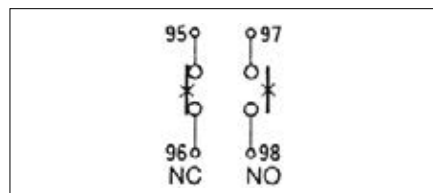

■ Auxiliary contact block (H65C to H400C)

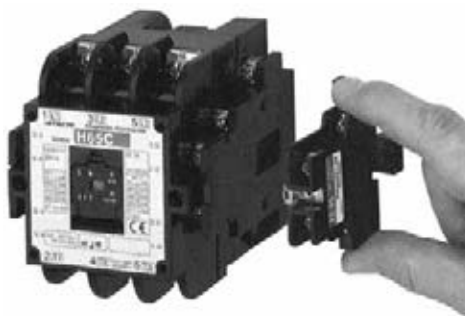

■ Coil surge absorber

Coil surge absorber will be installed by “Single Snap Action” (H65C to H125C), and H150C and above, it is constructed in coil assembly.



EASY MAINTENANCE AND INSPECTION

■ Quick contact inspection

Access to contacts is done by unfastening two screws and removing the cover.

■ Easy contact replacement

Contact can be removed/replaced by single snap action without taking off the contact spring (H80C to H400C).

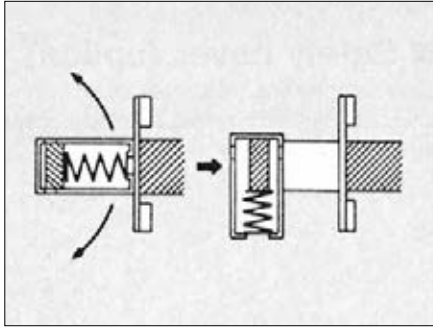

■ Easy wiring

- Adoption of washer-based self-up screw.
- Main terminal screw: up to H65C.
- Operation terminal screw: all models.
- Flat terminals built-in rugged studs facilitate connection of wires with a single spanner (H100C to H600C).



■ Front indication of nameplate



THERMAL OVERLOAD RELAYS

Plentiful products enable easy selection of motor protection.

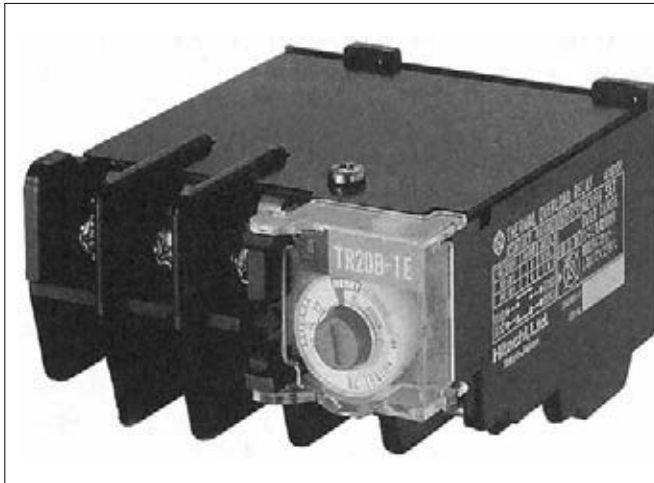

FRAME \ CATEGORY	Standard relay with overload protection (1E)	Relay with overload and single phasing protection (2E)
12B	applicable	applicable
20B	applicable	applicable
25B	applicable	applicable
50B	applicable	applicable
80B	applicable	applicable
150B	applicable	applicable
250B	applicable	applicable
400B	applicable	applicable
600B	applicable	applicable

■ Optional accessories

- Reset release...12B, 20B - 600B
- Safety cover...20B, 50B, 80B (except with CT)

■ Numbers of heat elements

- 1E...normally 2 Heat Elements. 3 Heat Elements type is also available as option.
- 2E...3 Heat Elements.

IEC STANDARD

Contactors and thermal overload relays conform to the IEC standard.

4. RATINGS AND SPECIFICATIONS

4.1 Standard Models



Item			Frame	8	10	20	25	35	50	65C	80C	100C	125C	150C	200C	250C	300C	400C	600C	800C																																														
Model	Electromagnetic contactor	without enclosure	Non-reversible	HS8	HS10	HS20	HS25	HS35	HS50	H65C	H80C	H100C	H125C	H150C	H200C	H250C	H300C	H400C	H600C	H800C																																														
		Reversible	—	HS10-R	HS20-R	HS25-R	HS35-R	HS50-R	—	H65C-R	H80C-R	H100C-R	H125C-R	H150C-R	H200C-R	H250C-R	H300C-R	H400C-R	H600C-R	H800C-R																																														
	Electromagnetic switch with 1E Thermal Overload Relay	without enclosure	Non-reversible	HS8-T	HS10-T	HS20-T	HS25-T	HS35-T	HS50-T	—	H65C-T	H80C-T	H100C-T	H125C-T	H150C-T	H200C-T	H250C-T	H300C-T	H400C-T	H600C-T	—																																													
			Reversible	—	HS10-RT	HS20-RT	HS25-RT	HS35-RT	HS50-RT	—	H65C-RT	H80C-RT	H100C-RT	H125C-RT	H150C-RT	H200C-RT	H250C-RT	H300C-RT	H400C-RT	H600C-RT	—																																													
		with enclosure	Non-reversible	—	SHS10-T	SHS20-T	SHS25-T	SHS35-T	SHS50-T	—	SH65C-T	SH80C-T	SH100C-T	SH125C-T	SH150C-T	SH200C-T	SH250C-T	SH300C-T	SH400C-T	SH600C-T	—																																													
			Reversible	—	SHS10-RT	SHS20-RT	SHS25-RT	SHS35-RT	SHS50-RT	—	SH65C-RT	SH80C-RT	SH100C-RT	SH125C-RT	SH150C-RT	SH200C-RT	SH250C-RT	SH300C-RT	SH400C-RT	SH600C-RT	—																																													
Thermal overload relay			TR12B-1E	TR20B-1E	TR25B-1E	TR50B-1E			—	TR80B-1E	TR150B-1E			TR250B-1E			TR400B-1E		TR600B-1E	—																																														
Rated insulation voltage (Ui)			690V							660V																																																								
Max. rated capacity of motor	JIS, JEM	Rated operational current (AC3)	200–220VAC	11A	13A	20 (18) A	26A	35A	50 (48) A	65A	80A	100A	125A	150A	180A	240A	300A	400A	600A	800A (AC2)																																														
			380–440VAC	7A	9A	17A	36A	32A	47A	65A	80A	100A	125A	150A	180A	240A	300A	400A	600A	800A (AC2)																																														
			500–550VAC	6A	9A	17A	20A	26A	37A	52A	72A	72A	80A	145A	145A	250A	350A	500A	—																																															
		Three-phase motor (AC3)	200–220VAC	2.2kW	2.7kW	4 (3.7) kW	5.5kW	7.5kW	11kW	15kW	19kW	25kW	30kW	37kW	45kW	55kW	60kW	75kW	110kW	150kW	200kW (AC2)																																													
	380–440VAC		2.7kW	4kW	7.5kW	11kW	15kW	22kW	30kW	37kW	50kW	60kW	75kW	90kW	120kW	150kW	200kW	300kW	400kW (AC2)																																															
	IEC	Rated operational current (AC3)	220–240VAC	11A	13A	22A	27A	40A	50A	65A	80A	105A	126A	150A	182A	240A	300A	400A	600A	800A (AC2)																																														
			380–440VAC	9A	12A	22A	26A	40A	50A	65A	80A	100A	125A	150A	180A	240A	300A	400A	600A	800A (AC2)																																														
	Single-phase motor (AC3)	Rated operational current (AC3)	200–220VAC	2.5kW	3.5kW	5.5kW	7.5kW	11kW	15kW	18.5kW	22kW	30kW	37kW	45kW	55kW	75kW	90kW	115kW	160kW	200kW (AC2)																																														
			380–440VAC	4kW	5.5kW	11kW	11kW	18.5kW	22kW	30kW	37kW	50kW	60kW	75kW	90kW	120kW	150kW	200kW	300kW	400kW (AC2)																																														
	Inching (AC4)	Rated operational current (AC3)	100–110VAC	0.4kW	0.5kW	0.9kW	1.2kW	1.7kW	—	—	—	—	—	—	—	—	—	—	—	—																																														
200–220VAC			0.8kW	1kW	1.8kW	—	—	—	—	—	—	—	—	—	—	—	—	—	—																																															
Rated capacity for resistance load (AC1)	(Electrical durability 0.5 million times) JIS, JEM and IEC	200–220VAC	20A	20A	32A	35A	50A	70A	80A	120A	135A	150A	200A	260A	300A	350A	420A	600A	800A (0.1 million times)																																															
		380–440VAC	20A	20A	32A	35A	50A	70A	80A	120A	135A	150A	200A	260A	300A	350A	420A	600A	800A (0.1 million times)																																															
Rated thermal current (Ith)	without enclosure	20A	20A	32A	35A	50A	70A	80A	120A	135A	150A	200A	260A	300A	350A	420A	600A	800A																																																
Open thermoelectric current (Ith)	with enclosure	15A	15A	26A	35A	44A	60A	65A	80A	100A	125A	150A	180A	240A	300A	400A	600A	—																																																
Characteristics of operation coil	Coil burden (max.) 50/60Hz	At power-on	100/90VA	100/90VA	100/90VA	100/90VA	135/125VA	135/125VA	220/190VA	490/420VA			400/400VA	480/480VA		1600/1600VA		1800/1800VA																																																
		After power-on	12/11VA	12/11VA	12/11VA	12/11VA	15/14VA	15/14VA	18/14VA	50/40VA			8/8VA	9/9VA		10/10VA		14/14VA																																																
	Coil consumption (mean)		3W					4.3W					6W	9.5W			7W	8W		8W																																														
	Pick-up voltage (% of rated voltage) (mean)		70%	70%	70%	70%	70%	70%	75%	75%			70%	70%		70%		70%																																																
	Drop-out voltage (% of rated voltage) (mean)		55%	55%	60%	60%	60%	60%	58%	58%			45%	45%		35%		35%																																																
Operating time (reference value)	At power-on	10–20ms							10–20ms	10–25ms			30–50ms	30–50ms		35–60ms		40–70ms																																																
		10–35ms							10–30ms	10–30ms			20–40ms	20–45ms		20–45ms		20–50ms																																																
Auxiliary contact specification	Type of constant		Twin contact							Twin contact																																																								
	Numbers	Standard	1N0 or 1NC		1N01NC or 2N02NC		2N02NC			2N02NC						3N03NC			4N04NC																																															
		Maximum	Four contacts can be added to the standard specification. Head-on2P: 2N0, 1N01NC, 2NC (Not applicable for the machine mounted with the side-on unit) Head-on4P: 4N0, 3N01NC, 2N02NC (Not applicable for the machine mounted with the side-on unit) Side-on2P: 1N01NC (Not applicable for the machine mounted with the head-on unit)																																																															
Rated operational current		<table border="1"> <thead> <tr> <th colspan="2">AC-12</th> <th colspan="3">AC-15</th> <th colspan="2">DC-12</th> <th colspan="3">DC-13</th> <th rowspan="2">Minimum rating</th> </tr> <tr> <th>110V</th> <th>220V</th> <th>110V</th> <th>220V</th> <th>440V</th> <th>110V</th> <th>220V</th> <th>110V</th> <th>220V</th> <th>440V</th> </tr> </thead> <tbody> <tr> <td>10A</td> <td>8A</td> <td>6A</td> <td>3A</td> <td>1.5A</td> <td>2.5A</td> <td>1A</td> <td>1.5A</td> <td>0.55A</td> <td>0.27A</td> <td>20V 5mA</td> </tr> </tbody> </table>										AC-12		AC-15			DC-12		DC-13			Minimum rating	110V	220V	110V	220V	440V	110V	220V	110V	220V	440V	10A	8A	6A	3A	1.5A	2.5A	1A	1.5A	0.55A	0.27A	20V 5mA	<table border="1"> <thead> <tr> <th colspan="3">AC-15</th> <th colspan="2">DC L/R≤40ms</th> <th rowspan="2">Minimum rating</th> </tr> <tr> <th>200–220V</th> <th>380–440V</th> <th>500–550V</th> <th>48V</th> <th>110V</th> </tr> </thead> <tbody> <tr> <td>2A</td> <td>1A</td> <td>0.75A</td> <td>0.7A</td> <td>0.3A</td> <td>24V 10mA</td> </tr> </tbody> </table>						AC-15			DC L/R≤40ms		Minimum rating	200–220V	380–440V	500–550V	48V	110V	2A	1A	0.75A	0.7A	0.3A	24V 10mA
AC-12		AC-15			DC-12		DC-13			Minimum rating																																																								
110V	220V	110V	220V	440V	110V	220V	110V	220V	440V																																																									
10A	8A	6A	3A	1.5A	2.5A	1A	1.5A	0.55A	0.27A	20V 5mA																																																								
AC-15			DC L/R≤40ms		Minimum rating																																																													
200–220V	380–440V	500–550V	48V	110V																																																														
2A	1A	0.75A	0.7A	0.3A	24V 10mA																																																													
With mechanical interlock		Provided as standard																																																																
IEC 35-mm rail mounting mechanism		Provided as standard																																																																
Durability	Mechanical	8 million times																																																																
	Electrical	2 million times			1.5 million times			1 million times			1 million times						0.5 million times																																																	
Available voltage range of operational coil		24–550V							24–550V						100–440V																																																			

- Notes:
- The ratings of the 200V class in the parenthesis when frames 20 and 50 are provided with an enclosure.
 - The rated thermal current applies to electromagnetic contactors.
 - The pick-up and drop-out voltages apply to 200V 60Hz power source. In case of 50Hz, the figures for frame H65C–125C are about 10% smaller and for frame H150C–800C are about the same.
 - Application of Category AC3 and AC2 to the reversible electromagnetic contactors and switches shall be limited to regular reversible operation in which a motor starts reverse rotation after it has once stopped. Category AC4 is applicable when the motor starts reverse rotation before it has completely stopped.
 - Operating time is a reference value where 200V 50Hz is applied to AC 200V coil. Operating time varies with coil voltage, frequency and phase so it is unsuitable for timing use.

- Testing conditions of electrical durability (Category AC3):
The making and breaking currents and operating frequency of the electrical durability are tested as shown in the right drawing according to test conditions of JIS C8201-4-1, JEM 1038 and IEC 60947-4-1.

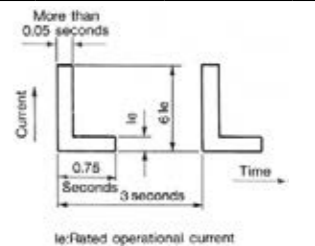

4.2 Thermal Overload Relays

Type		Standard type (1E) thermal overload relays (Overload and lock protections)									2E thermal overload relays (Overload, lock and phase-failure protections)														
Frame		12B	20B	25B	50B	80B	150B	250B	400B	600B	12B	20B	25B	50B	80B	150B	250B	400B	600B						
Model		TR12B-1E	TR20B-1E	TR25B-1E	TR50B-1E	TR80B-1E	TR150B-1E	TR250B-1E	TR400B-1E	TR600B-1E	TR12B-2E	TR20B-2E	TR25B-2E	TR50B-2E	TR80B-2E	TR150B-2E	TR250B-2E	TR400B-2E	TR600B-2E						
Heater specifications	Type of heater (Center RC value) (A)	0.2	0.3	0.2	0.3	20	9	20	80	(140)	(140)	(140)	0.2	0.3	0.2	0.3	20	9	20	80	(140)	(140)	(140)		
		0.5	0.8	0.5	0.8	22	11	28	105	(240)	(240)	(240)	0.4	0.5	0.4	0.5	22	11	28	105	(180)	(180)	(180)		
		1.2	1.4	1.2	1.4	15	15	40	130	(380)	(380)	(380)	0.6	0.8	0.6	0.8	15	15	40	130	(240)	(240)	(240)		
		2.4	3.8	2.4	3.8		20	55	(500)				1.0	1.2	1.0	1.2		20	55	(300)	(300)				
		5.0	6.8	5.0	6.8	28	67	40	55	TR20B-1E with CT (ratio 100:1) The figure in the parenthesis is the current of primary side.	1.4	1.8	1.4	1.8	28	67	40	55	TR20B-2E with CT (ratio 100:1) The figure in the parenthesis is the current of primary side.	1.4	1.8	1.4	1.8	(380)	(380)
		9	11	9	11	40	55				2.4	3.0	2.4	3.0	40	55				6.8	9.0	6.8	9.0	(500)	
*Numbers of Heat Elements		2	2	2	2	2	2				2	2	2	2	2	2				2	2	2	2	2	2
Heat Element consumption VA (VA/1 phase)		1.9	1.9	1.9	4.1	7.6	7.6	1.9	1.9	1.9	1.9	1.9	1.9	4.1	7.6	7.6	1.9	1.9	1.9	1.9	1.9	1.9			
External dimensions (mm)		A	45	63	63	85	102.5	102.5	148	164	230	45	63	63	85	102.5	102.5	148	164	230					
		B	71	45	54	45	55	87	120	135	179	71	45	54	45	55	87	129	135	179					
		C (Height to reset button)	78.5	72.5	72.5	73.5	73.5	73.5	167	167	170	78.5	72.5	72.5	73.5	73.5	73.5	167	167	170					
Net mass (kg)		0.1	0.15	0.17	0.25	0.36	0.37	2.0	2.0	5.0	0.1	0.15	0.17	0.25	0.36	0.37	2.0	2.0	5.0						
Terminal screw diam.	Main circuit	M3.5	M4	M4 (Line) M5 (Load)	M5	M6	M6 (Line) M8 (Load)	M10	M12	M12	M3.5	M4	M4 (Line) M5 (Load)	M5	M6	M6 (Line) M8 (Load)	M10	M12	M12						
	Operating circuit	M3.5	M3.5	M3.5	M3.5	M3.5	M3.5	M3.5	M3.5	M3.5	M3.5	M3.5	M3.5	M3.5	M3.5	M3.5	M3.5	M3.5	M3.5						
Contact Specifications	Type of contact		1NO1NC									1NO1NC													
	Arrangement																								
	Rated insulation voltage		AC660V									AC660V													
	Rated thermal current (A)		NC contact : 3, NO contact : 2									NC contact : 3, NO contact : 2													
	Rated operational current (A) (Values in parenthesis for automatic reset)	AC (AC15)	110V	NC contact : 3 (1), NO contact : 2 (0.5)									NC contact : 3 (1), NO contact : 2 (0.5)												
			220V	NC contact : 2 (1), NO contact : 1 (0.5)									NC contact : 2 (1), NO contact : 1 (0.5)												
			440V	NC contact : 1 (0.3), NO contact : 0.5 (0.2)									NC contact : 1 (0.3), NO contact : 0.5 (0.2)												
550V			NC contact : 1 (0.3), NO contact : 0.5 (0.2)									NC contact : 1 (0.3), NO contact : 0.5 (0.2)													
DC L/R ≤ 40ms		24V	NC contact : 1 (0.4), NO contact : 0.5 (0.2)									NC contact : 1 (0.4), NO contact : 0.5 (0.2)													
		48V	NC contact : 0.5 (0.2), NO contact : 0.2 (0.1)									NC contact : 0.5 (0.2), NO contact : 0.2 (0.1)													
	110V	NC contact : 0.2 (0.1), NO contact : 0.1 (0.05)									NC contact : 0.2 (0.1), NO contact : 0.1 (0.05)														
Minimum rating		***NC contact : 20V 5mA, NO contact : 20V 5mA									***NC contact : 20V 5mA, NO contact : 20V 5mA														
Reset method		**both a Manual and Automatic reset									**both a Manual and Automatic reset														
Separate mounting		option	standard	option	standard	option	refer Note 4)			option	standard	option	standard	option	refer Note 4.										
Option	Reset release	option									option														
	Lamp unit	—	option	—	option	—	—	—	—	—	—	option	—	—	—	—	—	—	—						
	Safety cover	—	option	—	option	—	—	—	—	—	—	—	option	—	—	—	—	—	—						
	Separate (DIN rail) mounting unit	option	—	—	—	—	—	—	—	—	—	option	—	—	—	—	—	—	—						
Applicable electromagnetic contactor		H8C	H20	H25	H35	H65C	H100C	H200C	H300C	H600C	H8C	H20	H25	H35	H65C	H100C	H200C	H300C	H600C						
		H10C	HS20	HS25	H50	H80C	H125C	H250C	H400C	H10C	HS20	HS25	H50	H80C	H125C	H250C	H400C								
		H11			HS35		H150C			H11			HS35		H150C										
		H12			HS50					H12			HS50												
		HS8, HS10									HS8, HS10														
Conforming standard		JIS C8201-4-1, JEM1038, IEC 60947-4-1, BS, VDE (3 Heat Elements only)									JIS, JEM, IEC, NEMA, VDE, BS														

Notes:

- In case of mounting for Electromagnetic Contactor H25, HS25 and required 15A or less RC value, applied 20B frame with extension terminals.
- In case of mounting for Electromagnetic Contactor H100C-150C and required 67A or less RC value, applied 80B frame with extension terminals.
- If 25B or 150B frame is mounted separately, ordering form shall be "Type" + "RC value" + "Separate Mounting". And 25B or 150B frame with Extension Terminals for both Load and Line terminals is supplied.
- For separate mounting of 150B frame and above rating, TR400B-□ separate mounting type is supplied.
- *3 Heat Elements type is available for standard type with 2 Heat Elements.
- Marked ☆ TR250B-TR600B-□ are Type names for TR20B-□ with CT (ratio 100:1)
On the Relay mounted to Electromagnetic Contactor at factory, marked ☆ Type name is not indicated.
- ** Relay is set in manual reset when shipped from factory.
- ***Please note that the thermal overload relay is not applicable in the installation site where any vibration/impact happens.

4.3 Electromagnetic Switches with 2E Thermal Overload Relay

<Electromagnetic contactor> <Electromagnetic switch> <Electromagnetic contactor With 2E thermal overload relay> <Electromagnetic switch>
 Non-reversible ... **HS** **-TK** **SHS** **-TK** Non-reversible ... **H** **-TK** **SH** **-TK**
 Reversible ... **HS** **-RTK** **SHS** **-RTK** Reversible ... **H** **-RTK** **SH** **-RTK**

Item				Frame	8	10	20	25	35	50	65C	80C	100C	125C	150C	200C	250C	300C	400C	600C						
Model	Electromagnetic switch with 2E thermal overload relay	without enclosure	Non-reversible	—	HS10-TK	HS20-TK	HS25-TK	HS35-TK	HS50-TK		H65C-TK	H80C-TK	H100C-TK	H125C-TK	H150C-TK	H200C-TK	H250C-TK	H300C-TK	H400C-TK	H600C-TK						
			Reversible	—	HS10-RTK	HS20-RTK	HS25-RTK	HS35-RTK	HS50-RTK		H65C-RTK	H80C-RTK	H100C-RTK	H125C-RTK	H150C-RTK	H200C-RTK	H250C-RTK	H300C-RTK	H400C-RTK	H600C-RTK						
		with enclosure	Non-reversible	—	SHS10-TK	SHS20-TK	SHS25-TK	SHS35-TK	SHS50-TK		SH65C-TK	SH80C-TK	SH100C-TK	SH125C-TK	SH150C-TK	SH200C-TK	SH250C-TK	SH300C-TK	SH400C-TK	SH600C-TK						
			Reversible	—	SHS10-RTK	SHS20-RTK	SHS25-RTK	SHS35-RTK	SHS50-RTK		SH65C-RTK	SH80C-RTK	SH100C-RTK	SH125C-RTK	SH150C-RTK	SH200C-RTK	SH250C-RTK	SH300C-RTK	SH400C-RTK	SH600C-RTK						
Thermal overload relay				TR12B-2E	TR20B-2E	TR25B-2E	TR50B-2E			TR80B-2E			TR150B-2E			TR250B-2E			TR400B-2E		TR600B-2E					
Rated insulation voltage (Ui)				690V						660VAC																
Max. rated capacity of motor	JIS, JEM () with enclosure	Rated operational current (AC3)	200–220VAC	11A	13A	20(18)A	26A	35A	50(48)A		65A	80A	100A	125A	150A	180A	240A	300A	400A	600A						
			380–440VAC	7A	9A	17A	36A	32A	47A		65A	80A	100A	125A	150A	180A	240A	300A	400A	600A						
			500–550VAC	6A	9A	17A	20A	26A	37A		52A	72A	72A	72A	80A	145A	145A	250A	350A	500A						
		Three-phase motor (AC3)	200–220VAC	2.2kW	2.7kW	4(3.7)kW	5.5kW	7.5kW	11kW		15kW	19kW	25kW	30kW	37kW	45kW	60kW	75kW	110kW	150kW						
			380–440VAC	2.7kW	4kW	7.5kW	11kW	15kW	22kW		30kW	37kW	50kW	60kW	75kW	90kW	120kW	150kW	200kW	300kW						
			500–550VAC	2.7kW	5.5kW	7.5kW	11kW	15kW	22kW		30kW	45kW	45kW	45kW	55kW	90kW	90kW	160kW	200kW	300kW						
	IEC	Rated operational current (AC3)	220–240VAC	11A	13A	22A	27A	40A	50A		65A	80A	105A	126A	150A	182A	240A	300A	400A	600A						
			380–440VAC	9A	12A	22A	26A	40A	50A		65A	80A	100A	125A	150A	180A	240A	300A	400A	600A						
		Three-phase motor (AC3)	200–220VAC	2.5kW	3.5kW	5.5kW	7.5kW	11kW	15kW		18.5kW	22kW	30kW	37kW	45kW	55kW	75kW	90kW	115kW	160kW						
			380–440VAC	4kW	5.5kW	11kW	11kW	18.5kW	22kW		30kW	37kW	50kW	60kW	75kW	90kW	120kW	150kW	200kW	300kW						
Single-phase motor (AC3) JIS, JEM and IEC	100–110VAC	0.4kW	0.5kW	0.9kW	1.2kW	1.7kW	—		—	—	—	—	—	—	—	—	—	—	—							
	200–220VAC	0.8kW	1kW	1.8kW	—	—	—		—	—	—	—	—	—	—	—	—	—	—							
Inching (AC4) (Inching ratio 50%, electrical durability 0.1 million times) JIS, JEM and IEC	200–220VAC	1.5kW	2.2kW	3.7kW	3.7kW	5.5kW	7.5kW		9kW	13kW	13kW	13kW	22kW	30kW	37kW	45kW	55kW	75kW								
	380–440VAC	2.2kW	3.7kW	5.5kW	5.5kW	7.5kW	11kW		15kW	19kW	19kW	19kW	30kW	37kW	45kW	55kW	55kW	75kW								
Characteristics of operation coil	Coil burden (max.) 50/60Hz	At power-on	100/90VA	100/90VA	100/90VA	100/90VA	135/125VA	135/125VA		220/190VA	490/420VA			400/400VA			480/480VA			1600/1600VA		1800/1800VA				
		After power-on	12/11VA	12/11VA	12/11VA	12/11VA	15/14VA	15/14VA		18/14VA	50/40VA			8/8VA			9/9VA			10/10VA		14/14VA				
	Coil consumption (mean)			3W				4.3W				6W		9.5W			7W			8W			8W		13W	
	Pick-up voltage (% of rated voltage) (mean)			70%				70%				75%		75%			70%			70%			70%		70%	
	Drop-out voltage (% of rated voltage) (mean)			55%				55%				60%				60%				60%				60%		60%
	Operating time (reference value)			At power-on			10–20ms				10–20ms		10–25ms			30–50ms			30–50ms			35–60ms		40–70ms		
After power-on				10–35ms				10–30ms		10–30ms			20–40ms			20–45ms			20–45ms		20–50ms					
Auxiliary contact specification	Type of constant			Twin contact						Twin contact																
	Numbers	Standard	1N0 or 1NC		1N01NC or 2N02NC		2N02NC			2N02NC						3N03NC						4N04NC				
		Maximum	Four contacts can be added to the standard specification. Head-on2P: 2N0, 1N01NC, 2NC (Cannot be mounted on the same body with the side-on unit at the same time) Head-on4P: 4N0, 3N01NC, 2N02NC (Cannot be mounted on the same body with the side-on unit at the same time) Side-on2P: 1N01NC (Cannot be mounted on the same body with the head-on unit at the same time)																							
Rated operational current			AC-12		AC-15			DC-12		DC-13		Minimum rating		AC-15			DC L/R≤40ms			Minimum rating						
			110V	220V	110V	220V	440V	110V	220V	110V	220V	440V			200–220V	380–440V	500–550V	48V	110V							
			10A	8A	6A	3A	1.5A	2.5A	1A	1.5A	0.55A	0.27A	20V 5mA		2A	1A	0.75A	0.7A	0.3A	24V 10mA						
With mechanical interlock				Provided as standard																						
IEC 35-mm rail mounting mechanism				Provided as standard																						
Durability	Mechanical			8 million times																						
	Electrical			2 million times				1.5 million times				1 million times				1 million times				0.5 million times						
Available voltage range of operational coil				24–550V																						
												24–550V				100–440V										

- Notes:
- The ratings of Max. rated capacity of motor in the parenthesis are provided with an enclosure.
 - The pick-up and drop-out voltage apply to 200V, 60Hz power source. In case of 50Hz, the figures for frame 8C–125C are about 10% smaller and figures for frame 150C–600C are about the same.
 - Application of Category AC3 and AC2 to the reversible electromagnetic switches shall be limited to regular reversible operation in which a motor starts reverse rotation after it has once stopped. Category AC4 is applicable when the motor starts reverse rotation before it has completely stopped. And the contactors used for reversible operation, they must be electrically interlocked using by mutual NC auxiliary contacts.
 - Since operating time depends on coil voltage, frequency or phase etc., the switches must not be applied for timing use.

4.4 DC Operated Electromagnetic Contactors

Non-reversible ... H □ -G
Reversible ... H □ -RG

Item		Frame	10	11	20	25	35	50	65C		80C	100C	125C	150C	200C	250C	300C	400C	600C	800C	
Model	Non-reversible		H10-G	H11-G	H20-G	H25-G	H35-G	H50-G	H65C-G		H80C-G	H100C-G	H125C-G	H150C-G	H200C-G	H250C-G	H300C-G	H400C-G	H600C-G	H800C-G	
	Reversible		—	H11-RG	H20-RG	H25-RG	H35RG	H50-RG	H65C-RG		H80C-RG	H100C-RG	H125C-RG	H150C-RG	H200C-RG	H250C-RG	H300C-RG	H400C-RG	H600C-RG	H800C-RG	
Rated insulation voltage (Ui)			660VAC								660VAC										
Max. rated capacity of motor	Rated operational current (AC3)	200–220VAC	12A	12A	20A	26A	35A	50A	65A		80A	100A	125A	150A	180A	240A	300A	400A	600A	800A (AC2)	
		380–440VAC	9A	9A	17A	24A	32A	47A	65A		80A	100A	125A	150A	180A	240A	300A	400A	600A	800A (AC2)	
		500–550VAC	8A	8A	12A	12A	26A	37A	52A		72A	72A	72A	80A	145A	145A	250A	350A	500A	—	
	Single-phase motor (AC3) JIS, JEM and IEC	100–110VAC	0.4kW	0.4kW	0.75kW	—	—	—	—		—	—	—	—	—	—	—	—	—	—	—
		200–220VAC	0.75kW	0.75kW	—	—	—	—	—		—	—	—	—	—	—	—	—	—	—	—
	Three-phase motor (AC3)	200–220VAC	2.5kW	2.5kW	4kW	5.5kW	7.5kW	11kW	15kW		19kW	25kW	30kW	37kW	45kW	60kW	75kW	110kW	150kW	—	
		380–440VAC	4kW	4kW	7.5kW	11kW	15kW	22kW	30kW		37kW	50kW	60kW	75kW	90kW	120kW	150kW	200kW	300kW	—	
		500–550VAC	4kW	4kW	7.5kW	7.5kW	15kW	22kW	30kW		45kW	45kW	45kW	55kW	90kW	90kW	160kW	200kW	300kW	—	
	Three-phase motor (AC2)	200–220VAC	2.5kW	2.5kW	4kW	5.5kW	7.5kW	11kW	15kW		19kW	25kW	30kW	37kW	45kW	60kW	75kW	110kW	150kW	200kW	
		380–440VAC	4kW	4kW	7.5kW	11kW	15kW	22kW	30kW		37kW	50kW	60kW	75kW	90kW	120kW	150kW	200kW	300kW	400kW	
500–550VAC		4kW	4kW	7.5kW	7.5kW	15kW	22kW	30kW		45kW	45kW	45kW	55kW	90kW	90kW	160kW	200kW	300kW	—		
Inching (AC4) (Inching ratio 50%, electrical durability 0.1 million times) JIS, JEM and IEC	200–220VAC	1.5kW	1.5kW	2.2kW	3.7kW	5.5kW	7.5kW	9kW		13kW	13kW	13kW	22kW	30kW	37kW	45kW	45kW	55kW	—		
	380–440VAC	2.2kW	2.2kW	3.7kW	5.5kW	7.5kW	11kW	15kW		19kW	19kW	19kW	30kW	37kW	45kW	55kW	55kW	75kW	—		
Rated capacity for resistance load (AC1) (Electrical durability 0.5 million times) JIS, JEM and IEC	200–220VAC	20A	20A	32A	35A	50A	70A	80A		120A	135A	150A	200A	260A	300A	350A	420A	600A	800A (0.1 million times)		
	380–440VAC	20A	20A	32A	35A	50A	70A	80A		120A	135A	150A	200A	260A	300A	350A	420A	600A	800A (0.1 million times)		
Rated thermal current (Ith)	without enclosure	20A	20A	32A	35A	50A	70A	80A		120A	135A	150A	200A	260A	300A	350A	420A	600A	800A		
Type of coil			Direct-input coil								Double coil										
Characteristics of operation coil (at 20°C cold start)	Coil burden (max.)	At power-on	11W		15W		18W		22W		300W			340W		380W		1400W		1400W	
		After power-on	11W		15W		18W		22W		4W			6W		7W		9W		12W	
	Time constant	At power-on	28ms		45ms		55ms		60ms		16ms			20ms		30ms		45ms		55ms	
		At release	28ms		45ms		55ms		60ms		40ms			65ms		85ms		90ms		105ms	
	Pick-up voltage (% of rated voltage) (mean)	55%	60%	60%	55%	55%	68%	70%	70%	70%	70%	70%	70%	70%	70%	70%	70%	70%	70%		
	Drop-out voltage (% of rated voltage) (mean)	22%	23%	17%	19%	20%	20%	20%	20%	20%	20%	20%	20%	20%	20%	20%	20%	20%	20%		
	Operating time 100VDC (reference value)	At power-on	25–30ms	25–30ms	35–40ms	40–45ms	50–55ms	25–40ms	30–50ms	30–50ms	35–60ms	35–60ms									
At release		15–20ms	10–15ms	20–25ms	20–25ms	20–25ms	40–50ms	20–40ms	20–45ms	20–45ms	25–50ms										
Auxiliary contact specification	Type of constant		Twin contact								Twin contact										
	Numbers	Standard	1NO	1NO1NC	1NO1NC	2NO2NC		2NO1NC ☆			2NO2NC		3NO3NC		4NO4NC						
Maximum		1NO	1NO1NC	2NO2NC (AX-20 is disabled)		2NO2NC (AX-20 is disabled)			4NO3NC ☆ (in case of reversible type; 3NO2NC)			4NO4NC (in case of reversible type; 3NO3NC)		4NO4NC							
Durability	Mechanical	10 million times							5 million times			5 million times		1 million times	1million times						
	Electrical	1 million times							1 million times			0.5 million times		0.5 million times	0.1 million times						
Available voltage range of operational coil			24–220V								24–220V			100–220V							

Notes:

1) Rating of Auxiliary Contact

Rated operational current					Rated thermal current	Minimum rating
AC (AC15)			DC L/R≤40ms			
200–220V	380–440V	500–550V	48V	110V		
2A	1A	0.75A	0.7A	0.3A	10A	24V 10mA

2) Since operating time depends on coil voltage etc., the contactor must not be applied for timing use.

3) When rectifier is used in the operating power source circuit, DC side must be interrupted.

If AC side of the circuit is interrupted, the drop-out time becomes longer because the rectifier constructs closed circuit with coil.

4) As a NC contact (wrap NC contact) of H80C–H125C-G is used for changing of coil, available numbers of auxiliary contacts are reduced.

Where marked (☆) and self-holding NO contact is included in the numbers.

4.5 Latched Electromagnetic Contactors

<AC operation> <DC operation>
 Non-reversible ... H □ -L H □ -LG
 Reversible ... H □ -RL H □ -RLG

Item		Frame	10	11	20	25	35	50	65C	80C	100C	125C	150C	200C	250C	300C	400C	600C		
Model	AC operation	Non-reversible	H10-L	H11-L	H20-L	H25-L	H35-L	H50-L	H65C-L	H80C-L	H100C-L	H125C-L	H150C-L	H200C-L	H250C-L	H300C-L	H400C-L	H600C-L		
		Reversible	—	H11-RL	H20-RL	H25-RL	H35-RL	H50-RL	H65C-RL	H80C-RL	H100C-RL	H125C-RL	H150C-RL	H200C-RL	H250C-RL	H300C-RL	H400C-RL	H600C-RL		
	DC operation	Non-reversible	H10-LG	H11-LG	H20-LG	H25-LG	H35-LG	H50-LG	H65C-LG	H80C-LG	H100C-LG	H125C-LG	H150C-LG	H200C-LG	H250C-LG	H300C-LG	H400C-LG	H600C-LG		
		Reversible	—	H11-RLG	H20-RLG	H25-RLG	H35-RLG	H50-RLG	H65C-RLG	H80C-RLG	H100C-RLG	H125C-RLG	H150C-RLG	H200C-RLG	H250C-RLG	H300C-RLG	H400C-RLG	H600C-RLG		
Rated insulation voltage (Ui)			660VAC							660VAC										
Max. rated capacity of motor	Rated operational current (AC3)	200–220VAC	12A	20A	26A	35A	50A	65A		80A	100A	125A	150A	180A	240A	300A	400A	600A		
		380–440VAC	9A	17A	24A	32A	47A	65A		80A	100A	125A	150A	180A	240A	300A	400A	600A		
		500–550VAC	8A	12A	12A	26A	37A	52A		72A	72A	72A	80A	145A	145A	250A	350A	500A		
	Single-phase motor (AC3) JIS, JEM and IEC	100–110VAC	0.4kW	0.75kW	—	—	—	—		—	—	—	—	—	—	—	—	—		
		200–220VAC	0.75kW	—	—	—	—	—		—	—	—	—	—	—	—	—	—		
	Three-phase motor (AC3)	200–220VAC	2.5kW	4kW	5.5kW	7.5kW	11kW	15kW		19kW	25kW	30kW	37kW	45kW	60kW	75kW	110kW	150kW		
		380–440VAC	4kW	7.5kW	11kW	15kW	22kW	30kW		37kW	50kW	60kW	75kW	90kW	120kW	150kW	200kW	300kW		
		500–550VAC	4kW	7.5kW	7.5kW	15kW	22kW	30kW		45kW	45kW	45kW	55kW	90kW	90kW	160kW	200kW	300kW		
	Three-phase motor (AC2)	200–220VAC	2.5kW	4kW	5.5kW	7.5kW	11kW	15kW		19kW	25kW	30kW	37kW	45kW	60kW	75kW	110kW	150kW		
		380–440VAC	4kW	7.5kW	11kW	15kW	22kW	30kW		37kW	50kW	60kW	75kW	90kW	120kW	150kW	200kW	300kW		
		500–550VAC	4kW	7.5kW	7.5kW	15kW	22kW	30kW		45kW	45kW	45kW	55kW	90kW	90kW	160kW	200kW	300kW		
	Rated capacity for resistance load (AC1) (Electrical durability 0.5 million times) JIS, JEM and IEC		200–220VAC	20A	32A	35A	50A	70A	80A		120A	135A	150A	200A	260A	300A	350A	420A	600A	
		380–440VAC	20A	32A	35A	50A	70A	80A		120A	135A	150A	200A	260A	300A	350A	420A	600A		
Rated thermal current (Ith)		without enclosure	20A	32A	35A	50A	70A	80A		120A	135A	150A	200A	260A	300A	350A	420A	600A		
Characteristics of operation coil (at 20°C cold start)	AC operation	Closing coil	Coil burden	45VA	140VA	165VA	220VA		700VA	400VA	480VA	2800VA	8200VA							
			Operating time (reference value) (ms)	10–15ms	15–25ms	15–25ms	15–25ms		15–30ms	30–50ms	30–50ms	20–40ms	30–40ms							
		Tripping coil	Coil burden	55VA	130VA	130VA	130VA		350VA	500VA	700VA	400VA	700VA							
			Operating time (reference value) (ms)	9–13ms	20–30ms	20–30ms	20–30ms		20–30ms	20–80ms	50–100ms	30–40ms	35–45ms							
	DC operation	Closing coil	Coil burden	50W	130W	100W	130W		225W	340W	380W	650W	680W							
			Operating time (reference value) (ms)	10–15ms	15–25ms	15–25ms	15–25ms		30–40ms	30–50ms	30–50ms	40–60ms	80–100ms							
		Tripping coil	Coil burden	65W	135W	135W	135W		300W	600W	630W	350W	480W							
			Operating time (reference value) (ms)	10–15ms	20–30ms	20–30ms	20–30ms		20–30ms	30–40ms	30–40ms	40–50ms	50–65ms							
Auxiliary contact specification	Type of constant		Twin contact							Twin contact										
	Numbers	Standard	—	1NC	1NO2NC							1NO2NC							3NO3NC	
		Maximum	—	1NC	3NO4NC (in case of reversible type: 2NO3NC)							3NO4NC (in case of reversible type: 2NO3NC)							3NO4NC	3NO3NC
Mechanical interlock unit (reversible)		—	—	Provided as standard							Provided as standard									
DIN rail mounting (non-reversible)		Provided as standard							—											
Durability	Mechanical		1 million times							0.25 million times							0.25 million times			
	Electrical		0.5 million times							0.1 million times							0.05 million times			
Available voltage range of operational coil		24–220V							100–220V							100–220V				

Notes:

1) Rating of Auxiliary Contact

Rated operational current					Rated thermal current	Minimum rating
AC (AC15)			DC L/R≤40ms			
200–220V	380–440V	500–550V	48V	110V		
2A	1A	0.75A	0.7A	0.3A	10A	24V 10mA

2) Numbers of the auxiliary contacts are not included a NO contact for cutting off power source of tripping

3) Since operating time depends on coil voltage, frequency, phase etc., the contactors must not be applied for timing use.

4.6 Contactor Relays

Model		XS4	
Numbers of contact		4 contacts	
Contact configuration (standard)		4a, 3a1b, 2a2b	
Contact configuration (maximum)		Four contacts can be added to the standard specification. Head-on 4 contacts: 4a, 3a1b, 2a2b Head-of 2 contacts: 2a, 1a1b, 2b Side-on 2 contacts: 1a1b	
Rated insulation voltage		690VAC	
Open thermoelectric current (Ith)		10A	
Rated usable current	Resistance load (AC-12)	110VAC	10A
		220VAC	8A
		440VAC	5A
		550VAC	5A
	Coil load (AC-15)	110VAC	6A
		220VAC	3A
		440VAC	1.5A
		550VAC	1.4A
	Resistance load (DC-12)	24VDC	5A
		48VDC	3A
		110VDC	2.5A
		220VDC	1A
	Coil load (DC-13)	24VDC	3A
48VDC		1.5A	
110VDC		0.55A	
220VDC		0.27A	
Minimum applicable rating		20V 5mA	
Operation coil characteristics	Coil capacity (average)	at power-on	100/90VA
		after power-on	12/11VA
	Coil loss (average)		3W
	Operating voltage (%/200 V, 60 Hz)		70%
	Release voltage (%/200 V, 60 Hz)		59%
Operating time (%/200 V, 60 Hz)	at power-on	10–20ms	
	at release	10–35ms	
IEC 35-mm rail mounting mechanism		Provided as standard	
Durability	Mechanical	8 million times	
	Electrical	0.5 million times	

Notes:

- 1) The contactor relay (XS4) is equipped with standard twin contact.
- 2) The head-on unit and the side-on unit cannot be mounted on the same body at the same time.
- 3) Since operating time depends on coil voltage, frequency, phase etc., the contactors must not be applied for timing use.

■ Auxiliary Contact Unit

Model		SXH-2	SXH-4	SXS-2
Type		Head-on		Side-on
Contact configuration (standard)		2a, 1a1b, 2b	4a, 3a1b, 2a2b	1a1b
Open thermoelectric current (Ith)		10A		
Rated usable current	Resistance load (AC-12)	110VAC	10A	
		220VAC	8A	
	Coil load (AC-15)	110VAC	6A	
		220VAC	3A	
		440VAC	1.5A	
	Resistance load (DC-12)	110VDC	2.5A	
		220VDC	1A	
	Coil load (DC-13)	48VDC	1.5A	
		110VDC	0.55A	
		220VDC	0.27A	
Minimum applicable rating		20V 5mA		

Notes:

- 1) The head-on unit and the side-on unit cannot be mounted on the same body at the same time.

Item				Numbers of contact	4 contacts		5 contacts					
Model				DC operation type	Latched type		DC operation type	Latched type				
					X4-G	X4-L			X5-G	X5-L		
						X4-LG		X5-LG				
Contact configuration				4a, 3a1b, 2a2b	3a* 2a1b 1a2b	5a, 4a1b, 3a2b, 2a3b	4a* 3a1b 2a2b 1a3b					
Rated insulation voltage				660VAC								
Rated thermal current (I _{th} (): more than 2 units, closely mounting)				15 (3) A	15 (3) A	15 (3) A	15 (3) A					
Contact Rating				Type	AC15	200–220VAC	3A	3A	3A	3A		
						380–440VAC	3A	3A	3A	3A		
						500–550VAC	2A	2A	2A	2A		
				DC L/R≤40ms	48VDC	1A	1A	1A	1A			
					110VDC	0.4A	0.4A	0.4A	0.4A			
					220VDC	0.2A	0.2A	0.2A	0.2A			
Minimum applicable rating				48V, 10mA		48V, 10mA						
Operation coil characteristics				Coil burden (max.) AC200V 50/60Hz, DC100V	at power-on	11W	—	11W	—			
					after power-on	11W	—	11W	—			
				Coil loss (average) (%/200 V, 60 Hz)				11W	—	11W	—	
				Operating voltage (%/200 V, 60 Hz)				50%	—	55%	—	
				Release voltage (%/200 V, 60 Hz)				19%	—	21%	—	
				Operating time (%/200 V, 60 Hz)				at power-on	15–25ms	—	25–30ms	—
								at release	15–20ms	—	10–15ms	—
				Latched type	AC operation	closing coil	Coil burden		45VA		45VA	
							Operating time (reference value)		10–15ms		10–15ms	
					Tripping coil	Coil burden		55VA		55VA		
Operating time (reference value)		9–13ms				9–13ms						
DC operation	closing coil	Coil burden			50W		50W					
		Operating time (reference value)			10–15ms		10–15ms					
	Tripping coil	Coil burden		65W		65W						
		Operating time (reference value)		10–15ms		10–15ms						
IEC 35-mm rail mounting mechanism				—	Provided as standard	—						
Durability				Mechanical		1 million times		1 million times				
				Electrical		0.5 million times		0.5 million times				
Available voltage range of operational coil				24–220V	24–440V	24–220V	24–440V					
					24–220V		24–220V					

Notes:

- Numbers of the auxiliary contacts for latched type are not included a NO contact for cutting off the power source of tripping coil (marked*).
- Since operating time depends on coil voltage, frequency, phase etc., the contactors are not applied for timing use.

5 STANDARD TYPE ELECTROMAGNETIC CONTACTORS AND SWITCHES

5.1 Coil Specifications

■ Standard Specification Table of Coil

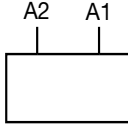
Frame	Specifications	Voltage / Frequency	Coil tap	Terminal code
8-50		100V 50Hz / 100-110V 60Hz	Common tap for 50Hz, 60Hz	
		200V 50Hz / 200-220V 60Hz		
		380-400V 50Hz / 400-440V 60Hz		
65-125		100V 50Hz / 100-110V 60Hz		
		200V 50Hz / 200-220V 60Hz		
		400V 50Hz / 400-440V 60Hz		
150-800		100-110V 50Hz / 60Hz		
		200-220V 50Hz / 60Hz		
		400-440V 50Hz / 60Hz		

■ Rated Operational Voltage and Color Classification of Coil

Color of outer wrapping and lead wire (COMMON line)	Rated operational voltage and frequency	
	8-50	65-125
Yellow	100V 50Hz / 100-110V 60Hz	
White	200V 50Hz / 200-220V 60Hz	
Red	380-400V 50Hz / 400-440V 60Hz	400V 50Hz / 400-440V 60Hz
Blue	Exclusive coil for all voltages* and frequencies used other than the above.	

NOTES:

1) For example, 200-220V, 60Hz includes all those of voltages between 200V and 220V. In case no special request is received, shipment will be made under the standard coil voltage indication even in case of 210V, 60Hz.

2) *	Frame	Manufacturable voltage range
	8-125C	24V-550V
	150C-800C	100V-440V

5.2 Performance

All models of Hitachi magnetic switches and contactors conform to the international standard (IEC 60947-4-1).

Frame	Making capacity*	Breaking capacity*	Applicable operating frequency	Durability	
				Electrical	Mechanical
8, 10	Not less than 10 times rated current	Not less than 8 times rated current	1200 operations per hour	2 million times	8 million times
20-50				1.5 million times	8 million times
65-200				1 million times	5 million times
250-600				0.5 million times	5 million times

NOTES: * Conform to category AC3 of IEC 60947-4-1

5.3 Application for the International Standards

Rated insulation voltage (V)	IEC 60947-4-1	BS	VDE	UL	CSA
150	All Frames	All Frames	All Frames	Authorization is required.	
250					
300					
380					
500					
600					
690 (H series: 660V)					

NOTES: This table shows application of the standard electromagnetic contactor.

5.4 Normal Service Condition

(1) Ambient temperature:

without enclosure	-5°C - 55°C
with enclosure	-5°C - 40°C

(2) Relative humidity: 45% - 85%

(3) Altitude: 2,000m or lower

(4) Atmosphere: must be free from corrosive gas, combustible gas, dust, vapor, salt etc.

(5) Environment: must be free from excessive vibration or shock.

5.5 Selection

■ Application of Cases Including Inching and Plugging (Category AC4)

In equipment and machinery which include inching and plugging (negative-phase braking), make and break of large starting rush current of motor will occur frequently. Category AC4 is applied for such usage. The rating of electromagnetic contactor is AC3. However, Category AC4 can be applied by lowering the rating.

Application examples for motors when assuming that starting rush current (inching current) of the motor is about 6 times that of the rated operational current are shown in **TABLE 1** and **TABLE 2**.

TABLE 1 INCHING (AC4)

Motor capacity (kW)	Inching ratio 50%				Inching ratio 75–100%					
	Electrical durability 0.1 million times		Electrical durability 0.5 million times		Electrical durability 0.1 million times		Electrical durability 0.5 million times			
	200–220V	380–440V	200–220V	380–440V	200–220V	380–440V	200–220V	380–440V		
0.1	HS10	HS10	HS10	HS10	HS10	HS10	HS10	HS10		
0.2									HS20	HS20
0.4										
0.75			HS35	HS25			HS20	HS20		
1.5										
2.2	HS20	HS20	H65C	HS35	HS20	HS20	HS50	HS35		
3.7										
5.5	HS35	HS25	H80C	HS50	H65C	HS35	H150C	H65C		
7.5										
9	H65C	HS50	H150C	H80C	H80C	HS50	H200C	H80C		
11										
13	H80C	H65C	H200C	H150C	H150C	H80C	H250C	H150C		
15										
18.5	H150C	H80C	H250C	H200C	H200C	H150C	H400C	H200C		
22										
30	H200C	H150C	H300C	H200C	H250C	H200C	H600C	H300C		
37										
37	H250C	H200C	H600C	H300C	H300C	H300C	—	H600C		
45										
55	H600C	H300C	—	—	—	—	—	—		
75										
75	—	H600C	—	—	—	—	—	—		

TABLE 2 PLUGGING (AC4)

Motor capacity (kW)	Plugging			
	Electrical durability 0.1 million times		Electrical durability 0.5 million times	
	200–220V	380–440V	200–220V	380–440V
0.2	HS10-R	HS10-R	HS10-R	HS10-R
0.4				
0.75			HS20-R	HS20-R
1.5				
2.2	HS20-R	HS20-R	HS35-R	HS35-R
3.7				
5.5	HS35-R	HS35-R	H80C-R	HS50-R
7.5				
11	H65C-R	HS50-R	H150C-R	H65C-R
15				
18.5	H80C-R	H65C-R	H200C-R	H80C-R
22				
30	H150C-R	H80C-R	H300C-R	H150C-R
37				
37	H200C-R	H150C-R	H400C-R	H200C-R
45				
45	H250C-R	H200C-R	H600C-R	H300C-R
75				
75	H300C-R	H200C-R	—	H400C-R
—				
—	H600C-R	H300C-R	—	H600C-R
—				
—	—	H600C-R	—	—

NOTES:

- Inching ratio (%) means $\frac{\text{Inching operation}}{\text{Inching operation} + \text{Normal operation (Category AC3)}} \times 100(\%)$
- Please enquire when using high inching frequency machine tools, hoists, cranes, etc., with an inching ratio of about 75–100%.

■ Application to AC Resistance Load

Category AC1 is applied when using a resistance load which does not necessitate consideration of rush current at starting such as the incandescent light, electric heater, etc.

Application of electromagnetic contactor to Category AC1 is shown in Table 3.

TABLE 3

Type	Category AC1 rating			
	Rated operational current (A)		Three-phase heater capacity (kW)	
	200–220V	380–440V	200–220V	380–440V
HS8, HS10	20 (15)	20 (15)	6 (5)	12 (10)
HS20	32 (26)	32 (26)	10 (9)	20 (18)
HS25	35 (33)	35 (33)	12 (12)	24 (24)
HS35	50 (44)	50 (44)	17 (15)	34 (30)
HS50	70 (60)	70 (60)	24 (20)	48 (40)
H65C	80 (65)	80 (65)	27 (22)	54 (45)
H80C	120 (80)	120 (80)	40 (27)	80 (55)
H100C	135 (100)	135 (100)	46 (34)	92 (69)
H125C	150 (125)	150 (125)	50 (43)	100 (86)
H150C	200 (150)	200 (150)	65 (60)	130 (100)
H200C	260 (200)	260 (200)	90 (60)	180 (120)
H250C	300 (240)	300 (240)	100 (80)	200 (160)
H300C	350 (300)	350 (300)	120 (100)	240 (200)
H400C	420 (400)	420 (400)	145 (135)	290 (270)
H600C	600 (600)	600 (600)	200 (200)	410 (410)
H800C	800	800	270	540

Notes:

- 1) The electrical durability is 0.5 million times.
- 2) Category AC1 is not applied to loads such as of mercury lamps where a large rush current flows at starting, and uses where resistance load is controlled at the primary side of the transformer.
- 3) Values of () are applied to Enclosure type.

■ Application to Capacitor Load

When a phase advancing capacitor circuit for improving the power factor is closed, a large in-rush current corresponding to the circuit impedance flows. **TABLE 4** shows the two cases of applications of the electromagnetic contactor: one is when a series reactor is installed to suppress the voltage or current

distortion due to installation of a capacitor so that the capacitor's in-rush current is 10 times or less, and the other is when no series reactor is installed so that the in-rush current is 20 times or less.

TABLE 4

Type	Three-phase (with a 6% series reactor)				Three-phase (with no series reactor)				Single-phase (with no series reactor); the contact are two poles in series			
	200–220V		380–440V		200–220V		380–440V		200–220V		380–440V	
	kvar	A	kvar	A	kvar	A	kvar	A	kvar	A	kvar	A
H10C, H11	4.2	12	6	9	3	9	4	6	1.8	9	2.4	6
H20	6.9	20	12	17	5	14	8	12	2.8	14	4.8	12
H25	9	26	16	23	7	20	12	17	4	20	6.8	17
H35	12	35	22	32	10	29	18	26	5.5	28	10.5	26
H50	17	49	32	46	13	38	26	38	7.5	38	15	38
H65C	22	64	42	61	18	52	35	51	10	50	20	50
H80C	27	78	51	74	22	64	45	65	12	60	26	65
H100C	32	92	64	92	29	84	55	79	16	80	31	78
H125C	36	104	72	104	34	98	70	101	19	95	40	100
H150C	48	139	96	139	44	127	88	127	25	125	50	125
H200C	62	179	120	173	53	153	105	152	30	150	60	150
H250C	65	188	130	188	65	188	130	188	37	185	75	188
H300C	84	242	180	260	80	231	160	231	46	230	92	230
H400C	109	315	200	289	100	289	200	289	57	285	115	288
H600C	159	459	300	433	150	433	300	433	86	430	173	433

Notes:

- 1) When no series reactor is provided, the in-rush current crest value is less than 20 times the capacitor's rated current and the durability is about 200,000 times.
- 2) The durability when a series reactor is provided is equivalent to category AC3 rating.

Application to Star-delta Starting

In star-delta starting, the motor coils are initially connected in star for acceleration of the load, when the motor's phase voltage is reduced to $1/\sqrt{3}$ (about 58%), then switched to delta when the load is up to speed and operated at full voltage.

1. Phase current protection method

A thermal overload relay is included in the delta connection to protect the motor by detecting a phase current. This method has the advantage over the line current protection method in that a thermal overload relay having a small RC value can be applied (an electromagnetic switch set can be used).

Example of the use as a star-delta starter

Type of load	Example of load	Life
No load	Lathe, drilling machine, etc. Spherical machinery, centrifugal pump, etc., which starts with the valve closed Pneumatic machinery, blower, etc., which starts with the shutter closed	500 thousand times
Square torque load Inertial load	Fluid machinery and pneumatic machinery Dehydrator, crank press, etc.	50 thousand times

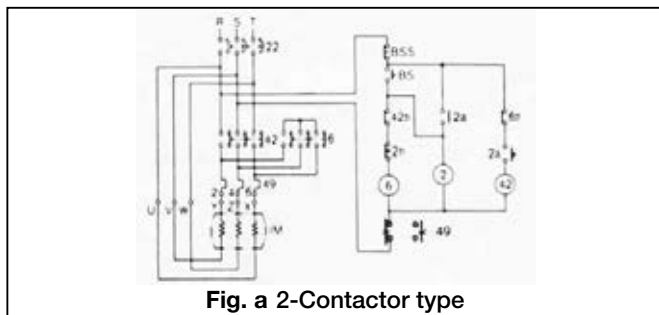
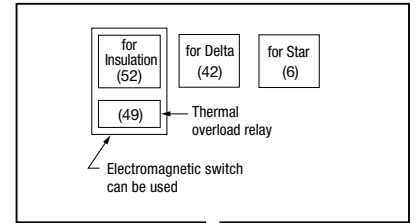
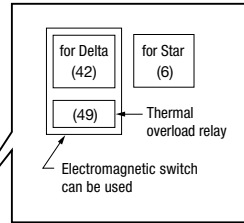

Fig. a 2-Contactor type

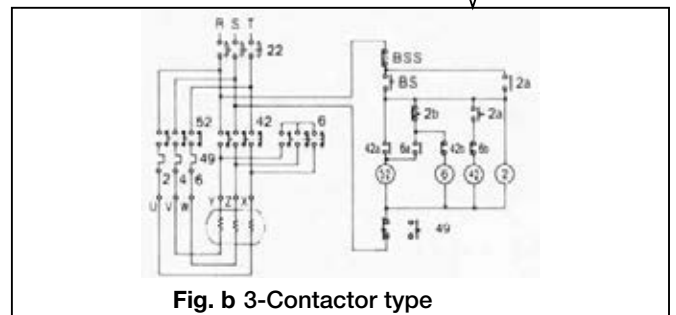

Fig. b 3-Contactor type

TABLE 5 Star-delta Starters of Phase Current Protection Method

Voltage	Max. motor capacity (kW)	Components							
		2-Contactor type		3-Contactor type			Electromagnetic switch with thermal overload relay (49)		
		Contactor for starting (6)	Switch for operation (42+49)	Switch for insulation (52+49)	Contactor for operation (42)	Contactor for starting (6)	RC (A)	Adjustable range (A)	Type
200V	5.5	H20	B) H20-TK	B) H20-TK	H20	H20	15	12-18	TR20B-2E
	7.5		B) H25-TK	B) H25-TK	H25				
	11		B) H35-TK	B) H35-TK	H35				
	15	H25	B) H50-TK	B) H50-TK	H50	H25	28	22-34	TR50B-2E
	18.5		H65C-TK	H65C-TK	H65C				
	22	H35	H80C-TK	H80C-TK	H80C	H35	40	32-48	TR80B-2E
	30		H100C-TK	H100C-TK	H100C				
	37	H65C	H125C-TK	H125C-TK	H125C	H65C	80	65-95	TR150B-2E
	45		H150C-TK	H150C-TK	H150C				
	55	H80C	H200C-TK	H200C-TK	H200C	H80C	105	90-120	TR250B-2E
	75		H300C-TK	H300C-TK	H300C				
	90	H125C	H400C-TK	H400C-TK	H400C	H125C	1.4 (140)	(110-180)	TR400B-2E
	110		H200C	H200C	H200C				
	132	H150C	H250C-TK	H250C-TK	H250C	H150C	2.4 (240)	(170-290)	TR250B-2E
150	H300C		H300C	H300C					
400V	5.5	H20	B) H20-TK	B) H20-TK	H20	H20	6.8	5-8	TR20B-2E
	7.5		B) H25-TK	B) H25-TK	H25				
	11		B) H35-TK	B) H35-TK	H35				
	15	H25	B) H50-TK	B) H50-TK	H50	H25	15	12-18	TR50B-2E
	18.5		H65C-TK	H65C-TK	H65C				
	22	H35	H80C-TK	H80C-TK	H80C	H35	20	16-24	TR80B-2E
	30		H100C-TK	H100C-TK	H100C				
	37	H50	H125C-TK	H125C-TK	H125C	H50	28	22-34	TR150B-2E
	45		H150C-TK	H150C-TK	H150C				
	55	H65C	H200C-TK	H200C-TK	H200C	H65C	40	32-48	TR250B-2E
	75		H300C-TK	H300C-TK	H300C				
	90	H80C	H400C-TK	H400C-TK	H400C	H80C	55	45-65	TR400B-2E
	110		H200C	H200C	H200C				
	132	H100C	H250C-TK	H250C-TK	H250C	H100C	80	65-95	TR150B-2E
	150		H300C-TK	H300C-TK	H300C				
	190	H125C	H400C-TK	H400C-TK	H400C	H125C	105	90-120	TR250B-2E
260	H200C		H200C	H200C					
	H150C	H250C-TK	H250C-TK	H250C	H150C	1.4 (140)	(110-170)	TR400B-2E	
		H300C-TK	H300C-TK	H300C					
	H200C	H400C-TK	H400C-TK	H400C	H200C	1.8 (180)	(140-220)	TR250B-2E	
		H250C-TK	H250C-TK	H250C					
	H300C	H200C	H200C	H200C	H300C	2.4 (240)	(200-80)	TR400B-2E	
		H300C	H300C	H300C					

Notes:

- Before use, adjust the current value using the thermal overload relay adjustment knob for the rated motor current x 0.58.
- The listed RC values are examples of a standard motor. Select an RC value which is closest to the rated motor current x 0.58.

2. Line current protection method

A thermal overload relay is included in the main circuit to protect the motor by detecting a line current.

Choose an electromagnetic contactor for star connection, an electromagnetic contactor for delta connection, and a thermal overload relay from Table 6-12. In addition, choose an electromagnetic contactor for insulation for a 3-contactor type.

Fig. a and Fig. b show connection examples.

Notes
 A 3-contactor type which does not apply a voltage to the motor coil is recommended while the motor is halted. For a 2-contactor type, it is recommended to install a switch (such as a FFB) on the primary side to open the switch circuit while the motor is halted.

Code (No.) of Components

No.	Components	Code	Components
2	Timer	IM	Motor
6	Contactor for starting	BS	Push button (start)
22	Fuse-free Circuit breaker	BSS	Push button (stop)
42	Contactor for operation	a	Contact which closes when the coil is energized
49	Thermal overload relay	b	Contact which opens when the coil is energized
52	Contactor for insulation		

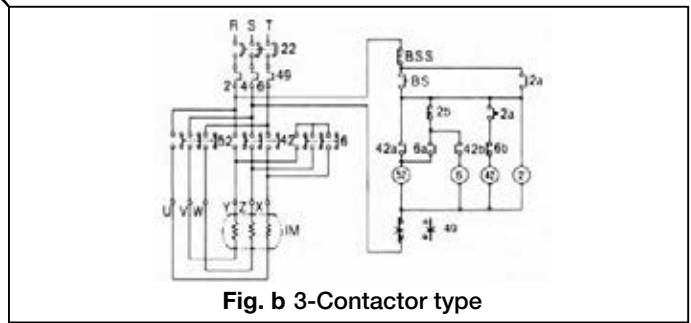
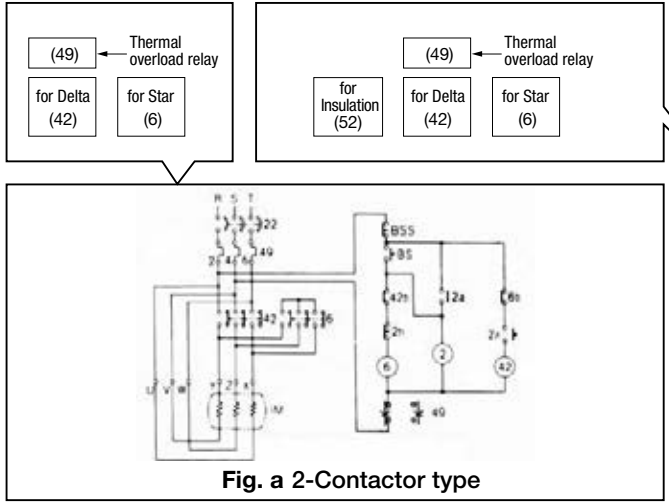

TABLE 6 Star-delta Starters of Line Current Protection Method

Voltage	Max. motor capacity (kW)	Components					
		Contactor for insulation (52)	Contactor for starting (6)	Contactor for operation (42)	Thermal overload relay (49)	RC (A)	Adjustable range (A)
200V	5.5	H20	H20	H20	For installing TR25B-2E solely	20	16-24
	7.5	H25		H25		TR50B-2E	28
	11	H35		H35	TR80B-2E		40
	15	H50	H25	H50		55	45-65
	18.5		H35		67	55-80	
	22	H65C	H50	H65C	For installing TR150B-2E solely	80	65-95
	30	H80C				H80C	105
	37	H100C	H65C	H100C	For installing TR400B-2E solely	130	110-150
	45	H125C		H125C		1.4(140)	(110-170)
	55	H150C	H80C	H150C	1.8(180)	(140-220)	
	75	H200C	H125C	H200C	2.4(240)	(200-280)	
	90	H250C	H150C	H250C	3.0(300)	(240-360)	
	110	H300C	H200C	H300C	5.0(500)	(300-450)	
	132	H400C	H250C	H400C			
150	H300C						
400V	5.5	H20	H20	H20	TR20B-2E	9	7-11
	7.5					15	12-18
	11			H25	H25	For installing TR25B-2E solely	20
	15	28	22-34				
	18.5	H35	H25	H35	TR50B-2E	40	32-48
	22	H50	H35	H50		TR80B-2E	55
	30				67		55-80
	37	H65C	H65C	H65C	For installing TR150B-2E solely	80	65-95
	45	H80C				H80C	105
	55	H100C	H80C	H100C	For installing TR400B-2E solely	130	110-150
	75	H125C				H125C	1.4(140)
	90	H150C	H125C	H150C	1.8(180)	(140-220)	
	110	H200C	H200C	H200C	For installing TR400B-2E solely	2.4(240)	(200-280)
	132	H250C				3.0(300)	(240-360)
	150	H300C	H300C	H300C	For installing TR400B-2E solely	3.8(380)	(300-450)
	190	H400C				5.0(500)	(400-600)
260							

Notes: If the motor current is different from the RC value above, adjust it using the adjustment knob.

5.6 Cautions

■ Allowable Installation Angle

Normal installation is made on the perpendicular plane as shown in Fig. b. As shown in Fig. a, the installation position with an inclination of up to 15° to the left and right and back and forth is permissible.

Limited to models of frames HS8–125C, side installation, in the condition where it is turned 90° in counterclockwise direction from the normal installation position, can also be made as shown in Fig. c, but in unavoidable cases. However, its life will be shortened by about 20%.



Fig. a Allowable installation angle



Fig. b Normal installation



Fig. c Side installation

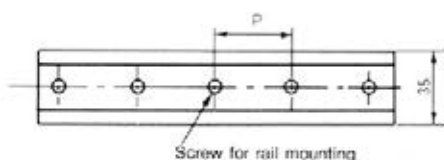
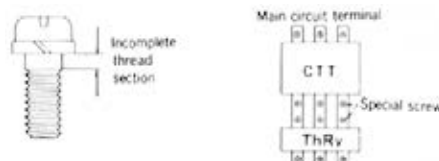

Fig. d



■ Cautions of Rail Mounting Type

- (1) Interval of screws for rail mounting
Interval of screws for rail mounting – as shown in Fig. d – shall be as follows.
 - Contactor relays and HS8–12 frame: $P \geq 300\text{mm}$
 - 20–50 frame: $P \geq 200\text{mm}$
- (2) Mounting space of switches
Mounting space of switches – as shown in Fig. e – shall be as follows.
 - Contactor relay: $\ell \geq 0\text{mm}$
 - Contactor switch: $\ell \geq 5\text{mm}$
- (3) Side installation is not allowed as shown in Fig. f.

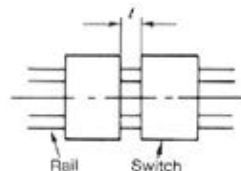

Fig. e

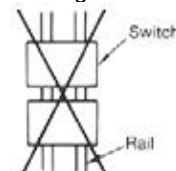

Fig. f

■ Applicable Wires and Suitable Tightening Torques





Frame	Specifications		Main circuit					Operating circuit					Contactor				
	Motor capacity 200V Class (kW)	Rated operational current 200V Class (A)	Terminal screw (mm)		Connectable wire (mm ²)	Maximum width of usable solderless terminal (mm)	Suitable tightening torque (N·m)		Terminal screw (mm)		Connectable wire (mm ²)	Maximum width of usable solderless terminal (mm)	Suitable tightening torque (N·m)		Mounting screw		Suitable tightening torque (N·m)
			Electro- magnetic contactor	Thermal overload relay			Electro- magnetic contactor	Thermal overload relay	Electro- magnetic contactor	Thermal overload relay			Electro- magnetic contactor	Thermal overload relay	Screw diameter (mm)	Number of screws	
8	2.2	11	M3.5	($\phi 1.6$) 2	7.8	1	M3.5	($\phi 1.6$) 2	7.8	1	M4	2	1.5				
10	2.5	12	M3.5	($\phi 1.6$) 2	7.8	1	M3.5	($\phi 1.6$) 2	7.8	1	M4	2	1.5				
20	4	20	M4	($\phi 2$) 3.5	9	1.5	M3.5	($\phi 1.6$) 2	7.8	1	M4	2	1.5				
25	5.5	26	M5	($\phi 2.6$) 8	10	3.5	M3.5	($\phi 1.6$) 2	7.8	1	M4	2	1.5				
35	7.5	35	M5	($\phi 3.2$) 14	12.5	3.5	M3.5	($\phi 1.6$) 2	7.8	1	M4	2	1.5				
50	11	50	M5	14	12.5	3.5	M3.5	($\phi 1.6$) 2	7.8	1	M4	2	1.5				
65C	15	65	M6	22	16.5	5	M3.5	($\phi 1.6$) 2	7.8	1	M4	2	1.5				
80C	19	80	M6	60	22	5	M3.5	($\phi 1.6$) 2	7.8	1	M5	2	3.5				
100C	25	100	M8 bolt	60	22	14	M3.5	($\phi 1.6$) 2	7.8	1	M5	2	3.5				
125C	30	125	M8 bolt	60	22	14	M3.5	($\phi 1.6$) 2	7.8	1	M6	2	5				
150C	37	150	M8 bolt	80	27	14	M3.5	($\phi 1.6$) 2	7.8	1	M6	2	5				
200C	45	180	M10 bolt	—	150	37	25	—	M3.5	($\phi 1.6$) 2	7.8	1	M8 bolt	4	14		
250C	60	240	M10 bolt	—	150	37	25	—	M3.5	($\phi 1.6$) 2	7.8	1	M8 bolt	4	14		
300C	75	300	M12 bolt	—	200	44	45	—	M3.5	($\phi 1.6$) 2	7.8	1	M8 bolt	4	14		
400C	110	400	M12 bolt	—	200	44	45	—	M3.5	($\phi 1.6$) 2	7.8	1	M8 bolt	4	14		
600C	150	600	M12 bolt	—	325	55	45	—	M4 M3.5 (coil)	M3.5	($\phi 1.6$) 2	7.8	1.5 1	1	M10 bolt	4	25
800C	200 (AC2)	800 (AC2)	M16 bolt (M12×2)	—	325	55	45	—	M4 M3.5 (coil)	—	($\phi 1.6$) 2	7.8	1.5 1	—	M10 bolt	4	25

Notes:

- 1) Except for certain special cases, the following are used for wiring of operating circuit electric wires, circuits of auxiliary contacts, etc.
 - Single wire: 1.6–600V polyvinyl chloride wire
 - Standard wire: 1.25 or 2 mm² 600V polyvinyl chloride wire
- 2) The adequate tightening torque in the former unit (kgf·cm) is ten times the values in the table above.

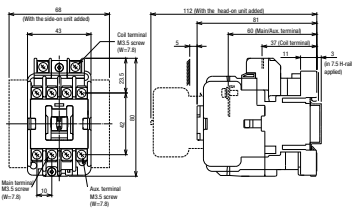
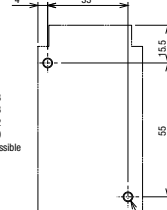
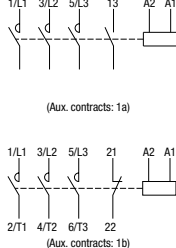
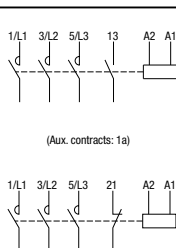
5.7 Appearance and Dimensions

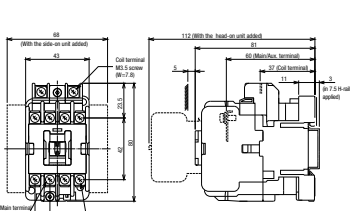
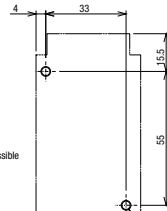
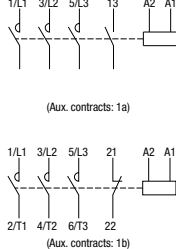
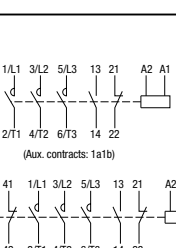
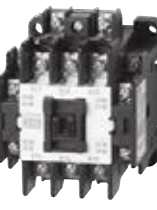
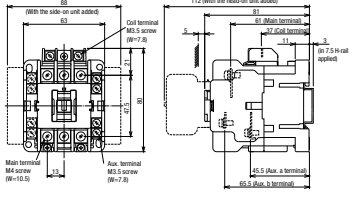
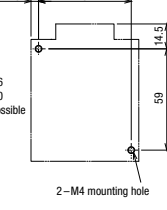
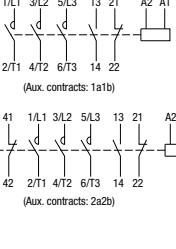
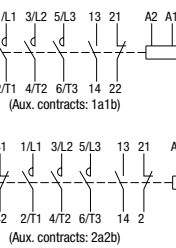
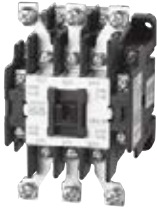
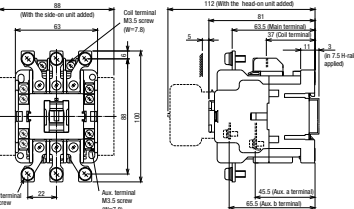
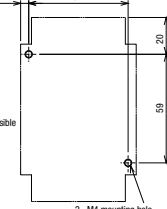
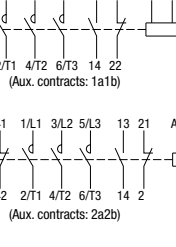
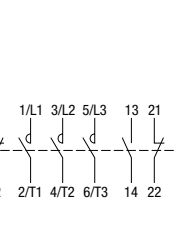

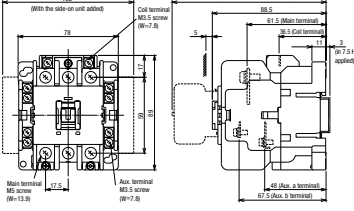
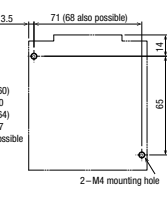
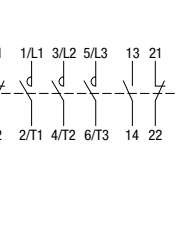





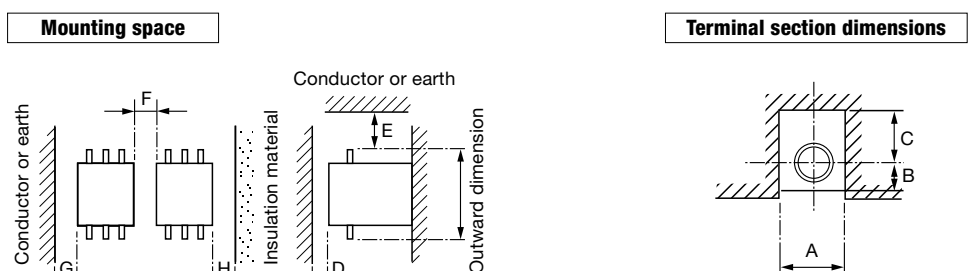

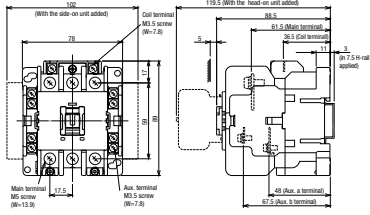
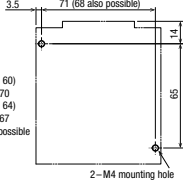
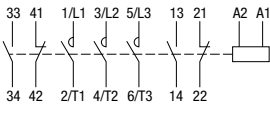
■ Non-Reversible Electromagnetic Contactors without Enclosure

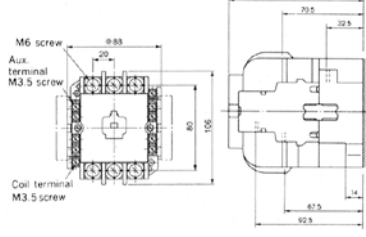
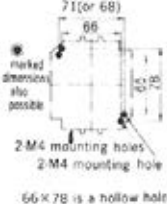
Appearance	Dimensions (mm) (Product mass)	Drilling plan	Contact arrangement	Terminal section dimensions (mm)										
 <p>HS8</p>	 <p>(0.34kg)</p>	 <p>30 x 48 34 x 48 34 x 52 35 x 50 also possible</p> <p>2-M4 mounting hole</p>	 <p>(Aux. contracts: 1a)</p>  <p>(Aux. contracts: 1b)</p>	<table border="1"> <tr> <td rowspan="3">Main circuit</td> <td>Terminal screw</td> <td>M3.5</td> </tr> <tr> <td rowspan="3">Terminal dimensions</td> <td>A</td> <td>7.8</td> </tr> <tr> <td>B</td> <td>3.3</td> </tr> <tr> <td>C</td> <td>5.4</td> </tr> </table>	Main circuit	Terminal screw	M3.5	Terminal dimensions	A	7.8	B	3.3	C	5.4
				Main circuit		Terminal screw	M3.5							
Terminal dimensions	A	7.8												
	B	3.3												
	C	5.4												
<table border="1"> <tr> <td rowspan="3">Operating circuit</td> <td>Terminal screw</td> <td>M3.5</td> </tr> <tr> <td rowspan="3">Terminal dimensions</td> <td>A</td> <td>8.3</td> </tr> <tr> <td>B</td> <td>4.4</td> </tr> <tr> <td>C</td> <td>4.1</td> </tr> </table>	Operating circuit	Terminal screw	M3.5	Terminal dimensions	A	8.3	B	4.4	C	4.1				
Operating circuit		Terminal screw	M3.5											
		Terminal dimensions	A		8.3									
	B		4.4											
C	4.1													
 <p>HS10</p>	 <p>(0.34kg)</p>	 <p>30 x 48 34 x 48 34 x 52 35 x 50 also possible</p> <p>2-M4 mounting hole</p>	 <p>(Aux. contracts: 1a)</p>  <p>(Aux. contracts: 1b)</p>	<table border="1"> <tr> <td rowspan="3">Main circuit</td> <td>Terminal screw</td> <td>M3.5</td> </tr> <tr> <td rowspan="3">Terminal dimensions</td> <td>A</td> <td>7.8</td> </tr> <tr> <td>B</td> <td>3.3</td> </tr> <tr> <td>C</td> <td>5.4</td> </tr> </table>	Main circuit	Terminal screw	M3.5	Terminal dimensions	A	7.8	B	3.3	C	5.4
				Main circuit		Terminal screw	M3.5							
Terminal dimensions	A	7.8												
	B	3.3												
	C	5.4												
<table border="1"> <tr> <td rowspan="3">Operating circuit</td> <td>Terminal screw</td> <td>M3.5</td> </tr> <tr> <td rowspan="3">Terminal dimensions</td> <td>A</td> <td>8.3</td> </tr> <tr> <td>B</td> <td>4.4</td> </tr> <tr> <td>C</td> <td>4.1</td> </tr> </table>	Operating circuit	Terminal screw	M3.5	Terminal dimensions	A	8.3	B	4.4	C	4.1				
Operating circuit		Terminal screw	M3.5											
		Terminal dimensions	A		8.3									
	B		4.4											
C	4.1													
 <p>HS20</p>	 <p>(0.41kg)</p>	 <p>54 x 56 54 x 60 also possible</p> <p>2-M4 mounting hole</p>	 <p>(Aux. contracts: 1a1b)</p>  <p>(Aux. contracts: 2a2b)</p>	<table border="1"> <tr> <td rowspan="3">Main circuit</td> <td>Terminal screw</td> <td>M4</td> </tr> <tr> <td rowspan="3">Terminal dimensions</td> <td>A</td> <td>10.6</td> </tr> <tr> <td>B</td> <td>5.3</td> </tr> <tr> <td>C</td> <td>7.5</td> </tr> </table>	Main circuit	Terminal screw	M4	Terminal dimensions	A	10.6	B	5.3	C	7.5
				Main circuit		Terminal screw	M4							
Terminal dimensions	A	10.6												
	B	5.3												
	C	7.5												
<table border="1"> <tr> <td rowspan="3">Operating circuit</td> <td>Terminal screw</td> <td>M3.5</td> </tr> <tr> <td rowspan="3">Terminal dimensions</td> <td>A</td> <td>8.3</td> </tr> <tr> <td>B</td> <td>4.4</td> </tr> <tr> <td>C</td> <td>4.1</td> </tr> </table>	Operating circuit	Terminal screw	M3.5	Terminal dimensions	A	8.3	B	4.4	C	4.1				
Operating circuit		Terminal screw	M3.5											
		Terminal dimensions	A		8.3									
	B		4.4											
C	4.1													
 <p>HS25</p>	 <p>(0.47kg)</p>	 <p>54 x 56 54 x 60 also possible</p> <p>2-M4 mounting hole</p>	 <p>(Aux. contracts: 1a1b)</p>  <p>(Aux. contracts: 2a2b)</p>	<table border="1"> <tr> <td rowspan="3">Main circuit</td> <td>Terminal screw</td> <td>M5</td> </tr> <tr> <td rowspan="3">Terminal dimensions</td> <td>A</td> <td>10</td> </tr> <tr> <td>B</td> <td>6</td> </tr> <tr> <td>C</td> <td>6</td> </tr> </table>	Main circuit	Terminal screw	M5	Terminal dimensions	A	10	B	6	C	6
				Main circuit		Terminal screw	M5							
Terminal dimensions	A	10												
	B	6												
	C	6												
<table border="1"> <tr> <td rowspan="3">Operating circuit</td> <td>Terminal screw</td> <td>M3.5</td> </tr> <tr> <td rowspan="3">Terminal dimensions</td> <td>A</td> <td>8.3</td> </tr> <tr> <td>B</td> <td>4.4</td> </tr> <tr> <td>C</td> <td>4.1</td> </tr> </table>	Operating circuit	Terminal screw	M3.5	Terminal dimensions	A	8.3	B	4.4	C	4.1				
Operating circuit		Terminal screw	M3.5											
		Terminal dimensions	A		8.3									
	B		4.4											
C	4.1													
 <p>HS35</p>	 <p>(0.53kg)</p>	 <p>(from 60) 65 x 70 (from 64) 65 x 67 also possible</p> <p>2-M4 mounting hole</p>		<table border="1"> <tr> <td rowspan="3">Main circuit</td> <td>Terminal screw</td> <td>M5</td> </tr> <tr> <td rowspan="3">Terminal dimensions</td> <td>A</td> <td>13.9</td> </tr> <tr> <td>B</td> <td>7</td> </tr> <tr> <td>C</td> <td>6.8</td> </tr> </table>	Main circuit	Terminal screw	M5	Terminal dimensions	A	13.9	B	7	C	6.8
				Main circuit		Terminal screw	M5							
Terminal dimensions	A	13.9												
	B	7												
	C	6.8												
<table border="1"> <tr> <td rowspan="3">Operating circuit</td> <td>Terminal screw</td> <td>M3.5</td> </tr> <tr> <td rowspan="3">Terminal dimensions</td> <td>A</td> <td>8.3</td> </tr> <tr> <td>B</td> <td>4.4</td> </tr> <tr> <td>C</td> <td>4.1</td> </tr> </table>	Operating circuit	Terminal screw	M3.5	Terminal dimensions	A	8.3	B	4.4	C	4.1				
Operating circuit		Terminal screw	M3.5											
		Terminal dimensions	A		8.3									
	B		4.4											
C	4.1													

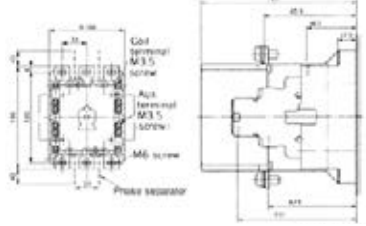
Note: Do not operate with the cover removed (Check by removing the cover only when inspecting the contact and always be sure to securely push in the cover after checking).

Model	Dimensions					Minimum mounting space (mm)				
	D	E	F	G	H	D	E	F	G	H
HS8	5	15	5	10	5	5	15	5	10	5
HS10	5	15	5	10	5	5	15	5	10	5
HS20	5	15	5	10	5	5	15	5	10	5
HS25	5	15	5	10	5	5	15	5	10	5
HS35	5	15	5	10	5	5	15	5	10	5

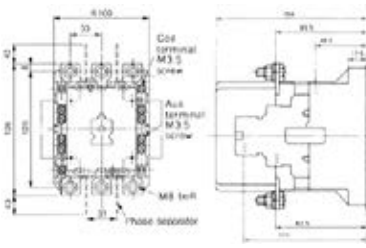
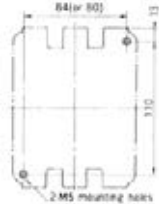

Appearance	Dimensions (mm) (Product mass)	Drilling plan	Contact arrangement	Terminal section dimensions (mm)																				
 <p>HS50</p>	 <p>(0.53kg)</p>	 <p>2-M4 mounting hole</p>		<table border="1"> <tr> <td rowspan="3">Main circuit</td> <td>Terminal screw</td> <td>M5</td> </tr> <tr> <td rowspan="3">Terminal dimensions</td> <td>A</td> <td>13.9</td> </tr> <tr> <td>B</td> <td>7</td> </tr> <tr> <td>C</td> <td>6.8</td> </tr> <tr> <td rowspan="3">Operating circuit</td> <td>Terminal screw</td> <td>M3.5</td> </tr> <tr> <td rowspan="3">Terminal dimensions</td> <td>A</td> <td>8.3</td> </tr> <tr> <td>B</td> <td>4.4</td> </tr> <tr> <td>C</td> <td>4.1</td> </tr> </table>	Main circuit	Terminal screw	M5	Terminal dimensions	A	13.9	B	7	C	6.8	Operating circuit	Terminal screw	M3.5	Terminal dimensions	A	8.3	B	4.4	C	4.1
Main circuit	Terminal screw	M5																						
	Terminal dimensions	A	13.9																					
		B	7																					
C		6.8																						
Operating circuit	Terminal screw	M3.5																						
	Terminal dimensions	A	8.3																					
		B	4.4																					
C		4.1																						
 <p>H65C</p>	 <p>(1.2kg)</p>	 <p>2-M4 mounting holes 66x78 is a hollow hole</p>	 <p>These contacts are added in case of aux. contacts 4N04NC.</p>	<table border="1"> <tr> <td rowspan="3">Main circuit</td> <td>Terminal screw</td> <td>M6</td> </tr> <tr> <td rowspan="3">Terminal dimensions</td> <td>A</td> <td>16.5</td> </tr> <tr> <td>B</td> <td>8</td> </tr> <tr> <td>C</td> <td>8</td> </tr> <tr> <td rowspan="3">Operating circuit</td> <td>Terminal screw</td> <td>M3.5</td> </tr> <tr> <td rowspan="3">Terminal dimensions</td> <td>A</td> <td>7.8</td> </tr> <tr> <td>B</td> <td>5.5</td> </tr> <tr> <td>C</td> <td>4.5</td> </tr> </table>	Main circuit	Terminal screw	M6	Terminal dimensions	A	16.5	B	8	C	8	Operating circuit	Terminal screw	M3.5	Terminal dimensions	A	7.8	B	5.5	C	4.5
Main circuit	Terminal screw	M6																						
	Terminal dimensions	A	16.5																					
		B	8																					
C		8																						
Operating circuit	Terminal screw	M3.5																						
	Terminal dimensions	A	7.8																					
		B	5.5																					
C		4.5																						
 <p>H80C</p>	 <p>(2.0kg)</p>	 <p>2 M5 mounting holes</p>	 <p>These contacts are added in case of aux. contacts 4N04NC.</p>	<table border="1"> <tr> <td rowspan="3">Main circuit</td> <td>Terminal screw</td> <td>M6</td> </tr> <tr> <td rowspan="3">Terminal dimensions</td> <td>A</td> <td>22</td> </tr> <tr> <td>B</td> <td>8</td> </tr> <tr> <td>C</td> <td>11</td> </tr> <tr> <td rowspan="3">Operating circuit</td> <td>Terminal screw</td> <td>M3.5</td> </tr> <tr> <td rowspan="3">Terminal dimensions</td> <td>A</td> <td>7.8</td> </tr> <tr> <td>B</td> <td>5</td> </tr> <tr> <td>C</td> <td>4.5</td> </tr> </table>	Main circuit	Terminal screw	M6	Terminal dimensions	A	22	B	8	C	11	Operating circuit	Terminal screw	M3.5	Terminal dimensions	A	7.8	B	5	C	4.5
Main circuit	Terminal screw	M6																						
	Terminal dimensions	A	22																					
		B	8																					
C		11																						
Operating circuit	Terminal screw	M3.5																						
	Terminal dimensions	A	7.8																					
		B	5																					
C		4.5																						
 <p>H100C, H125C</p>	 <p>(2.2kg)</p>	 <p>2 M5 mounting holes</p>	 <p>These contacts are added in case of aux. contacts 4N04NC.</p>	<table border="1"> <tr> <td rowspan="3">Main circuit</td> <td>Terminal screw</td> <td>M8 bolt</td> </tr> <tr> <td rowspan="3">Terminal dimensions</td> <td>A</td> <td>22</td> </tr> <tr> <td>B</td> <td>8</td> </tr> <tr> <td>C</td> <td>11</td> </tr> <tr> <td rowspan="3">Operating circuit</td> <td>Terminal screw</td> <td>M3.5</td> </tr> <tr> <td rowspan="3">Terminal dimensions</td> <td>A</td> <td>7.8</td> </tr> <tr> <td>B</td> <td>5</td> </tr> <tr> <td>C</td> <td>4.5</td> </tr> </table>	Main circuit	Terminal screw	M8 bolt	Terminal dimensions	A	22	B	8	C	11	Operating circuit	Terminal screw	M3.5	Terminal dimensions	A	7.8	B	5	C	4.5
Main circuit	Terminal screw	M8 bolt																						
	Terminal dimensions	A	22																					
		B	8																					
C		11																						
Operating circuit	Terminal screw	M3.5																						
	Terminal dimensions	A	7.8																					
		B	5																					
C		4.5																						



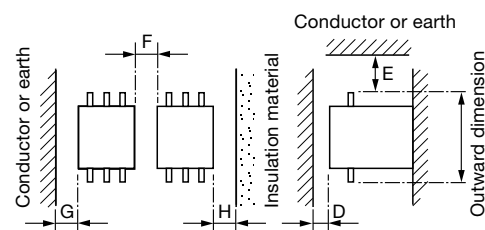

Model	Dimensions					Minimum mounting space (mm)				
	D	E	F	G	H	D	E	F	G	H
HS50	5	15	5	10	5	5	15	5	10	5
H65C	1	15	5	10	5	1	15	5	10	5
H80C	1	15	10	10	10	1	15	10	10	10
H100C, H125C	1	15	10	10	10	1	15	10	10	10

Mounting space

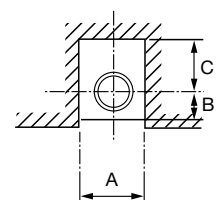

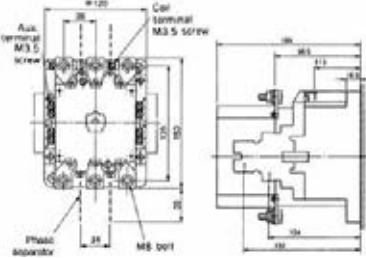
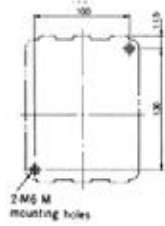
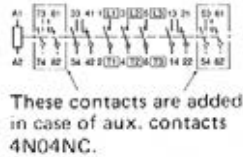
Terminal section dimensions

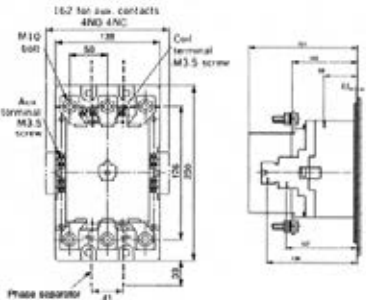
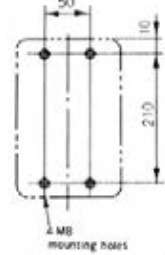
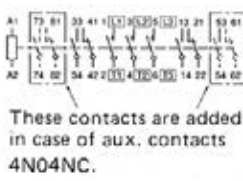
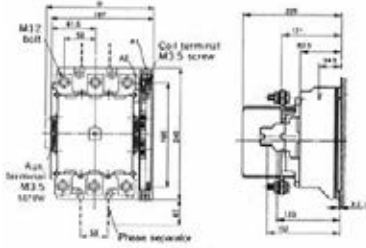
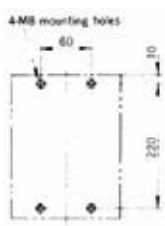
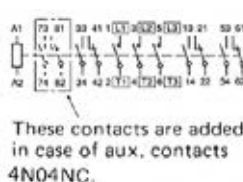
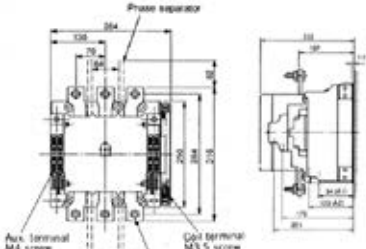
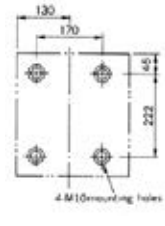

Appearance	Dimensions (mm) (Product mass)	Drilling plan	Contact arrangement	Terminal section dimensions (mm)		
 <p>H150C</p>	 <p>(3.3kg)</p>	 <p>2 M6 M mounting holes</p>	 <p>These contacts are added in case of aux. contacts 4N04NC.</p>	Main circuit	Terminal screw	M8 bolt
					Terminal dimensions	A
B	10					
Operating circuit	Terminal screw	M3.5				
	Terminal dimensions	A	7.8			
		B	6			
C	4.5					
 <p>H200C, H250C</p>	 <p>(5.5kg)</p>	 <p>4 M6 mounting holes</p>	 <p>These contacts are added in case of aux. contacts 4N04NC.</p>	Main circuit	Terminal screw	M10 bolt
					Terminal dimensions	A
B	12.5					
Operating circuit	Terminal screw	M3.5				
	Terminal dimensions	A	7.8			
		B	6			
C	4.5					
<p>H300C, H400C</p>	 <p>(9.7kg)</p>	 <p>4 M8 mounting holes</p>	 <p>These contacts are added in case of aux. contacts 4N04NC.</p>	Main circuit	Terminal screw	M12 bolt
					Terminal dimensions	A
B	15					
Operating circuit	Terminal screw	M3.5				
	Terminal dimensions	A	7.8			
		B	6			
C	4.5					
<p>H600C</p>	 <p>(22kg)</p>	 <p>4 M10 mounting holes</p>		Main circuit	Terminal screw	M12 bolt
					Terminal dimensions	A
B	16					
Operating circuit	Terminal screw	M4				
	Terminal dimensions	A	9			
		B	7.2			
C	5					

Type	Dimensions		Minimum mounting space (mm)			
	D	E	F	G	H	
H150C	1	15	10	10	10	
H200C, H250C	1	20	10	10	10	
H300C, H400C	1	30	10	10	10	
H600C	1	50	10	10	10	

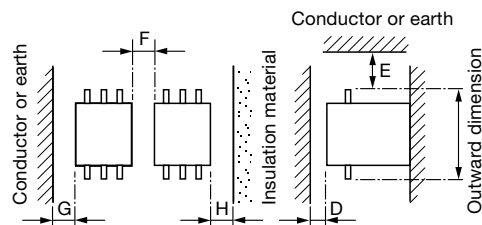

Mounting space

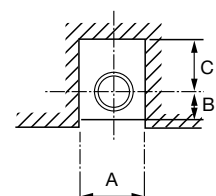

Terminal section dimensions

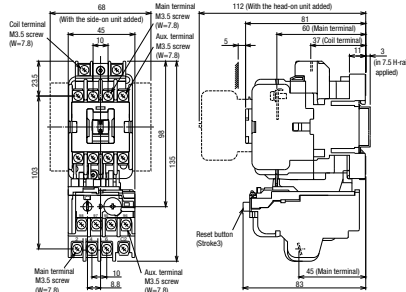
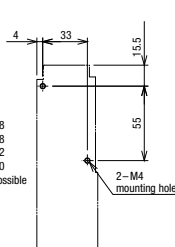
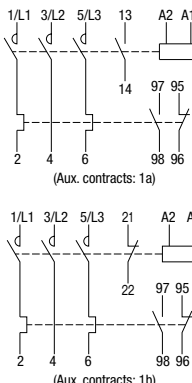

■ Non-Reversible Electromagnetic Switches without Enclosure

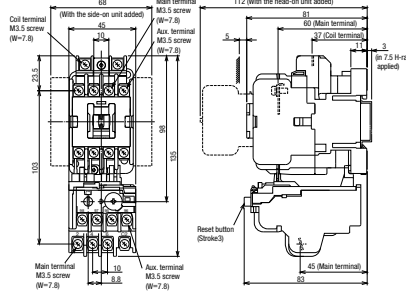
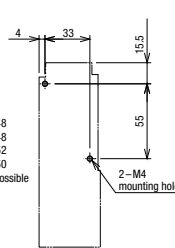
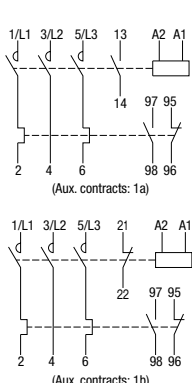
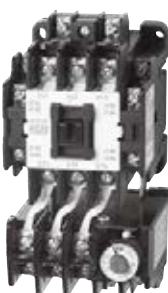
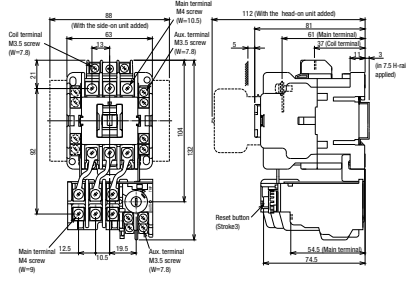
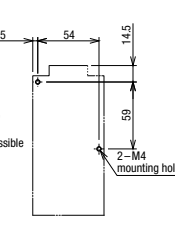
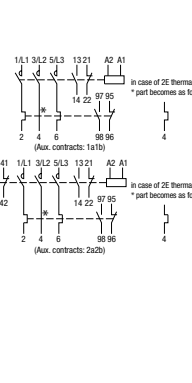
Appearance	Dimensions (mm) (Product mass)	Drilling plan	Contact arrangement	Terminal section dimensions (mm)				
				Electro-magnetic contactor	Thermal overload relay			
 <p>HS8-T</p>	 <p>(0.45kg)</p>	 <p>30 x 48 34 x 48 34 x 52 35 x 50 also possible</p> <p>2-M4 mounting hole</p>	 <p>(Aux. contracts: 1a)</p>	Main circuit	Terminal screw	M3.5	M3.5	
					Terminal dimensions	A	7.8	7.8
						B	3.3	6
				C		5.4	4.5	
Operating circuit	Terminal screw	M3.5	M3.5					
	Terminal dimensions	A	8.3	7.6				
		B	4.4	4				
C		4.1	4.5					
 <p>HS10-T</p>	 <p>(0.45kg)</p>	 <p>30 x 48 34 x 48 34 x 52 35 x 50 also possible</p> <p>2-M4 mounting hole</p>	 <p>(Aux. contracts: 1a)</p>	Main circuit	Terminal screw	M3.5	M3.5	
					Terminal dimensions	A	7.8	7.8
						B	3.3	6
				C		5.4	4.5	
Operating circuit	Terminal screw	M3.5	M3.5					
	Terminal dimensions	A	8.3	7.6				
		B	4.4	4				
C		4.1	4.5					
 <p>HS20-T</p>	 <p>(0.57kg)</p>	 <p>54 x 56 54 x 60 also possible</p> <p>2-M4 mounting hole</p>	 <p>(Aux. contracts: 1a1b) (Aux. contracts: 2a2b)</p>	Main circuit	Terminal screw	M4	M4	
					Terminal dimensions	A	10.6	9
						B	5.3	9
				C		7.5	5	
Operating circuit	Terminal screw	M3.5	M3.5					
	Terminal dimensions	A	8.3	7.8				
		B	4.4	4				
C		4.1	4.5					



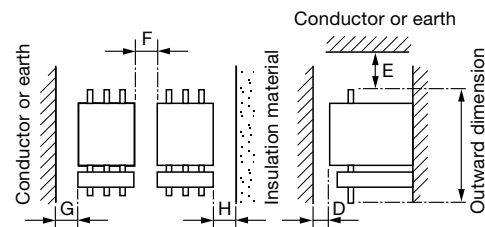

Type	Dimensions					Minimum mounting space (mm)				
	D	E	F	G	H	D	E	F	G	H
HS8-T	5	15	5	10	5	5	15	5	10	5
HS10-T	5	15	5	10	5	5	15	5	10	5
HS20-T	5	15	5	10	5	5	15	5	10	5

Mounting space

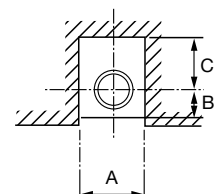

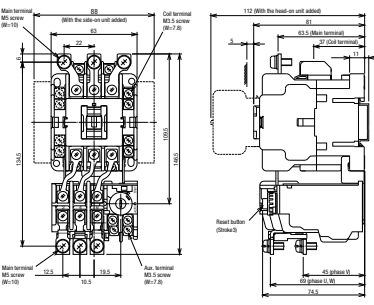
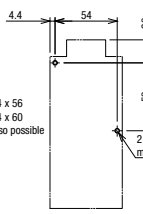
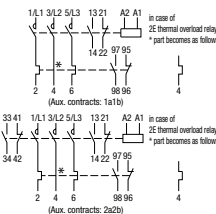
Terminal section dimensions

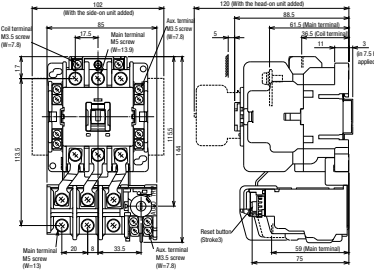
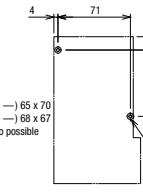
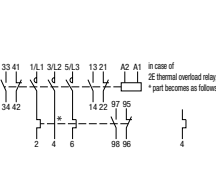

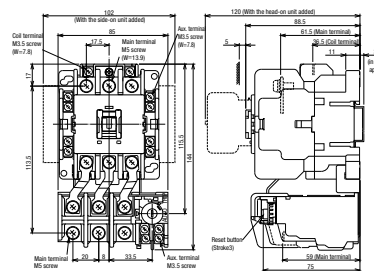
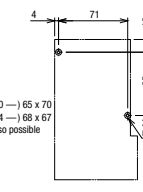
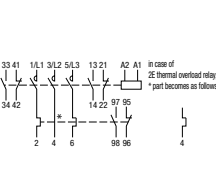
Appearance	Dimensions (mm) (Product mass)	Drilling plan	Contact arrangement	Terminal section dimensions (mm)			
				Electro-magnetic contactor	Thermal overload relay		
 <p>HS25-T</p>	 <p>(0.63kg)</p>	 <p>54 x 56 54 x 60 also possible</p>		Main circuit	Terminal screw	M5	M5
					Terminal dimensions	A	10
B	6	6					
C	6	5.5					
Operating circuit	Terminal screw	M3.5	M3.5				
		Terminal dimensions	A	8.3	7.8		
			B	4.4	4		
C	4.1		4.5				
 <p>HS35-T</p>	 <p>(0.79kg)</p>	 <p>(60 —) 65 x 70 (64 —) 68 x 67 also possible</p>		Main circuit	Terminal screw	M5	M5
					Terminal dimensions	A	13.9
B	7	6.5					
C	6.8	7					
Operating circuit	Terminal screw	M3.5	M3.5				
		Terminal dimensions	A	8.3	7.8		
			B	4.4	4		
C	4.1		4.5				
 <p>HS50-T</p>	 <p>(0.79kg)</p>	 <p>(60 —) 65 x 70 (64 —) 68 x 67 also possible</p>		Main circuit	Terminal screw	M5	M5
					Terminal dimensions	A	13.9
B	7	6.5					
C	6.8	7					
Operating circuit	Terminal screw	M3.5	M3.5				
		Terminal dimensions	A	8.3	7.8		
			B	4.4	4		
C	4.1		4.5				





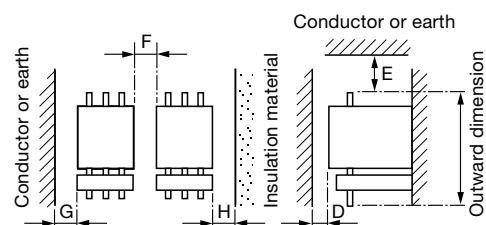

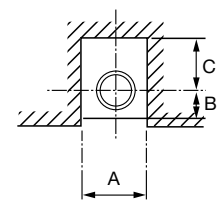

Type	Dimensions					Minimum mounting space (mm)				
	D	E	F	G	H	D	E	F	G	H
HS25-T	5	15	5	10	5	5	15	5	10	5
HS35-T	5	15	5	10	5	5	15	5	10	5
HS50-T	5	15	5	10	5	5	15	5	10	5

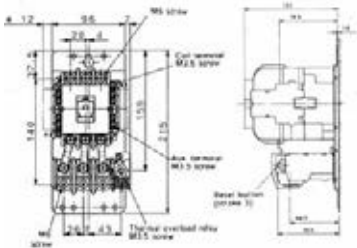
Mounting space

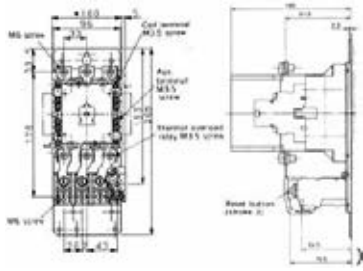
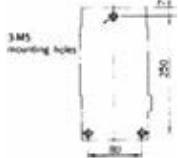

Terminal section dimensions

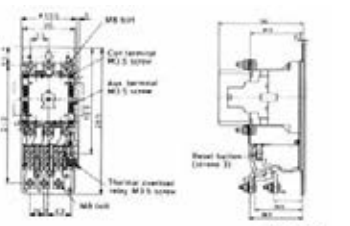
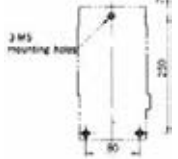

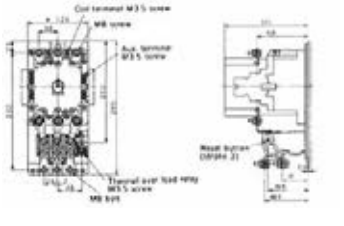
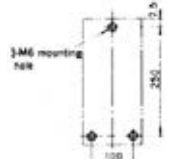
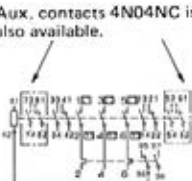
Appearance	Dimensions (mm) (Product mass)	Drilling plan	Contact arrangement	Terminal section dimensions (mm)			
				Electro-magnetic contactor	Thermal overload relay		
 <p>H65C-T</p>	 <p>(1.9kg)</p>	 <p>3 M5 mounting holes</p>	 <p>Aux. contacts 4N04NC is also available.</p>	Main circuit	Terminal screw	M6	M6
					Terminal dimensions	A	16.5
B	8	8.5					
C	8	8					
Operating circuit	Terminal screw	M3.5	M3.5				
	Terminal dimensions	A	7.8	7.8			
B		5.5	4				
C		4.5	4.5				
 <p>H80C-T</p>	 <p>(2.8kg)</p>	 <p>3 M5 mounting holes</p>	 <p>Aux. contacts 4N04NC is also available.</p>	Main circuit	Terminal screw	M6	M6
					Terminal dimensions	A	22
B	8	8.5					
C	11	8					
Operating circuit	Terminal screw	M3.5	M3.5				
	Terminal dimensions	A	7.8	7.8			
B		5	4				
C		4.5	4.5				
 <p>H100C-T H125C-T</p>	 <p>(3.0kg)</p>	 <p>3 M5 mounting holes</p>	 <p>Aux. contacts 4N04NC is also available.</p>	Main circuit	Terminal screw	M8 bolt	M8 bolt
					Terminal dimensions	A	22
B	8	10					
C	11	13					
Operating circuit	Terminal screw	M3.5	M3.5				
	Terminal dimensions	A	7.8	7.8			
B		5	4				
C		4.5	4.5				
 <p>H150C-T</p>	 <p>(3.9kg)</p>	 <p>3 M6 mounting holes</p>	 <p>Aux. contacts 4N04NC is also available.</p>	Main circuit	Terminal screw	M8 bolt	M8 bolt
					Terminal dimensions	A	27
B	10	10					
C	9.5	13					
Operating circuit	Terminal screw	M3.5	M3.5				
	Terminal dimensions	A	7.8	7.8			
B		6	4				
C		4.5	4.5				

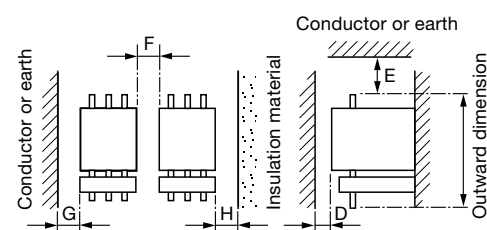

Type	Dimensions					Minimum mounting space (mm)				
	D	E	F	G	H	D	E	F	G	H
H65C-T	1	15	5	10	5	1	15	5	10	5
H80C-T	1	15	10	10	10	1	15	10	10	10
H100C-T H125C-T H150C-T	1	15	10	10	10	1	15	10	10	10

Mounting space

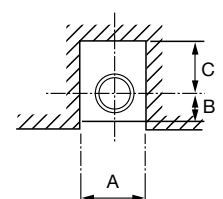

Terminal section dimensions

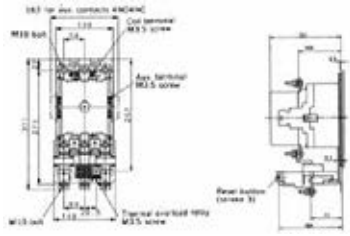
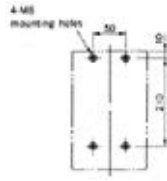
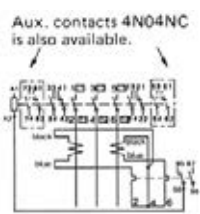
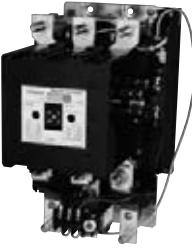
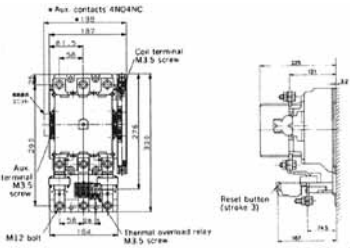
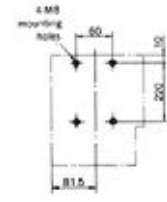
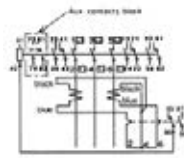

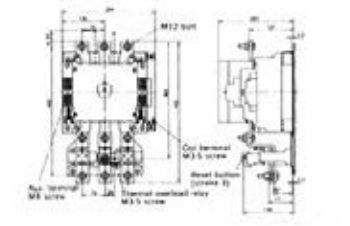
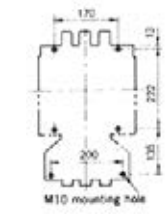
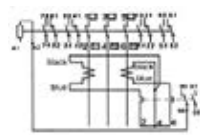
Appearance	Dimensions (mm) (Product mass)	Drilling plan	Contact arrangement	Terminal section dimensions (mm)			
				Terminal section	Electro-magnetic contactor	Thermal overload relay	
 <p>H200C-T H250C-T</p>	 <p>(7.2kg)</p>		 <p>Aux. contacts 4N04NC is also available.</p>	Main circuit	Terminal screw	M12 bolt	—
					Terminal dimensions	A	37
B	12.5	—					
Operating circuit	Terminal dimensions	Terminal screw	M3.5	M3.5			
		A	7.8	7.8			
		B	6	4			
C	4.5	4.5					
 <p>H300C-T H400C-T</p>	 <p>(12kg)</p>			Main circuit	Terminal screw	M10 bolt	—
					Terminal dimensions	A	44
B	15	—					
C	20	—					
Operating circuit	Terminal dimensions	Terminal screw	M3.5	M3.5			
		A	7.8	7.8			
		B	6	4			
C	4.5	4.5					
 <p>H600C-T</p>	 <p>(28kg)</p>			Main circuit	Terminal screw	M12 bolt	—
					Terminal dimensions	A	55
B	16	—					
C	28	—					
Operating circuit	Terminal dimensions	Terminal screw	M4	M3.5			
		A	9	4			
		B	7.2	4			
C	5	4.5					

Type	Dimensions				
	D	E	F	G	H
H200C-T H250C-T	1	20	10	10	10
H300C-T H400C-T	1	30	10	10	10
H600C-T	1	50	10	10	10

Mounting space

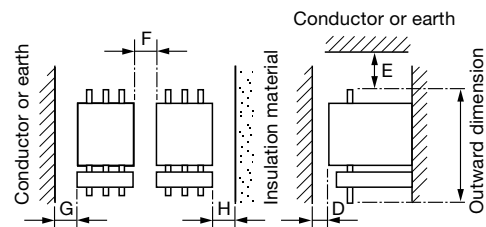

Terminal section dimensions

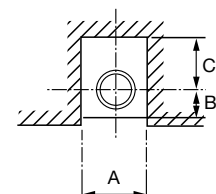

■ Reversible Electromagnetic Contactors without Enclosure

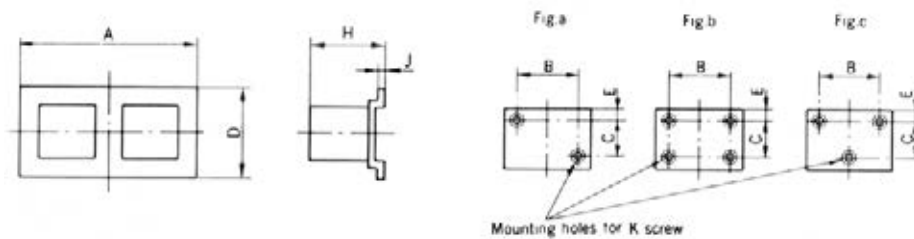

Model	Dimensions (mm)				Drilling plan (mm)					Mass (kg)
	A	D	H	J	Fig.	B	C	E	K	
HS10-R	84	71.5	95.5	17	a	73	54	5.5	2-M4	0.62
HS20-R	172	90	101.5	1.6	c	155	75	7.5	3-M4	1.2
HS25-R	172	100	101.5	1.6	c	155	75	7.5	3-M4	1.3
HS35-R	200	120	114	1.6	c	180	100	7.5	3-M5	2
HS50-R	200	120	114	1.6	c	180	100	7.5	3-M5	2
H65C-R	200	120	123	1.6	c	180	100	7.5	3-M5	2.9
H80C-R	240	170	160	1.6	c	220	150	10	3-M6	5.0
H100C-R H125C-R	240	170	160	1.6	c	220	150	10	3-M6	5.1
H150C-R	280	200	171	2.3	c	260	150	10	3-M6	6.2
H200C-R H250C-R	330	290	198	3.2	c	300	260	15	3-M8	14
H300C-R H400C-R	385	300	244	3.2	c	340	270	15	3-M8	25
H600C-R	578	316	258	25	b	480	278	19	4-M10	53
H800C-R	578	380	258	25	b	480	278	51	4-M10	53

■ Reversible Electromagnetic Switches without Enclosure

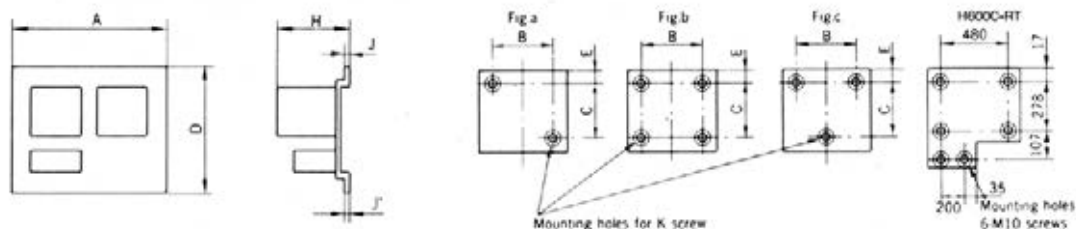

Model	Dimensions (mm)				Drilling plan (mm)					Mass (kg)
	A	D	H	J (J')	Fig.	B	C	E	K	
HS10-RT	84	128	95.5	17	a	73	54	5.5	2-M4	0.68
HS20-RT	172	135	101.5	1.6	c	155	75	7.5	3-M4	1.45
HS25-RT	172	144	101.5	1.6	c	155	75	7.5	3-M4	1.5
HS35-RT	200	158	114	1.6	c	180	100	7.5	3-M5	2.4
HS50-RT	200	158	114	1.6	c	180	100	7.5	3-M5	2.4
H65C-RT	200	186	123	1.6	c	180	170	7.5	3-M5	3.1
H80C-RT	240	228	160	1.6	c	220	210	10	3-M6	5.8
H100C-RT H125C-RT	240	247	160	1.6	c	220	210	10	3-M6	6.4
H150C-RT	280	277	171	2.3	c	260	240	10	3-M6	9.2
H200C-RT H250C-RT	330	341	198	3.2	c	300	260	15	3-M8	18
H300C-RT H400C-RT	385	360	244	3.2	c	340	270	15	3-M8	30
H600C-RT	578	453	258	25	—	—	—	—	—	58

■ Electromagnetic Switches without Enclosure

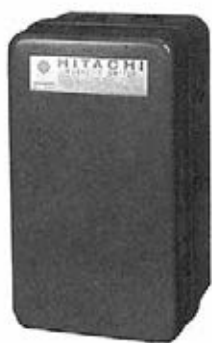

SHS35-T

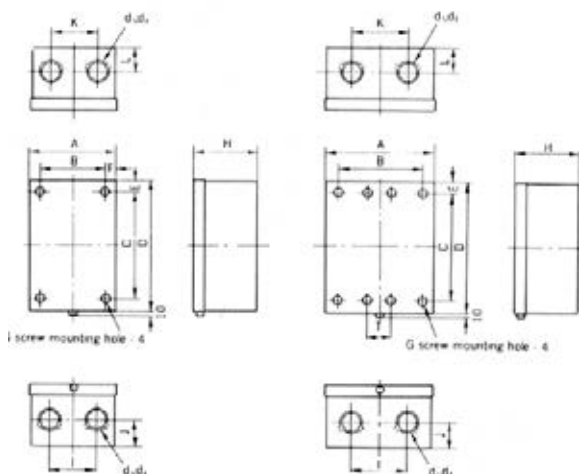

Color of enclosure

Munsell Code
5Y7/1

Frame	Model	Mass (kg)	Dimensions (mm)														
			A	B	C	D	E	F	G	H	I	J	K	L	T	d ₁	d ₂
10	*1 SHS10-T	0.68	85	65	140	165	12.5	7.5	M4×4	112	35	25	35	25	—	22	—
20	SHS20-T	1.4	110	75	140	175	17.5	17.5	M5×4	114	35	30	35	30	—	22	—
25	SHS25-T	2.6	150	105	210	255	22.5	22.5	M5×4	130	50	40	50	40	—	22	28
35	SHS35-T	2.8															
50	SHS50-T	2.8															
65C	SH65C-T	4.6	206	160	290	336	23	23	M6×4	165	100	80	100	100	—	35	45
80C	*2 SH80C-T	5.1															
100C	*2 SH100C-T	7.5	235	185	385	435	25	25	M8×4	200	120	90	120	105	—	45	52
125C	*2 SH125C-T	12	285	185	385	560	88	50	M8×4	225	120	95	120	120	—	55	65
150C	*2 SH150C-T	13															
200C	*2 SH200C-T	14															
250C	*2 SH250C-T	14.5															
300C	*2 SH300C-T	25															
400C	*2 SH400C-T	25	340	208	515	690	63	66	M10×4	258	160	107	160	107	—	62	78
600C	*2 SH600C-T	55	603	500	800	950	75	50	M12×4	400	280	202	280	202	—	100	120
10B	B)SH10B-RT	1.5	110	75	140	175	17.5	17.5	M5×4	114	35	30	35	30	—	22	—
10	SHS10-RT	2.0	160	130	135	167	16	15	M4×4	97	90	25	100	25	—	22	—
20	SHS20-RT	2.3	195	160	140	175	17.5	17.5	M5×4	116.5	80	30	120	30	—	22	—
25	SHS25-RT	4.3	235	190	210	255	22.5	22.5	M5×4	130	120	40	140	40	—	22	28
35	SHS35-RT	4.5															
50	SHS50-RT	4.5															
65C	SH65C-RT	8.5	340	270	290	336	23	35	M6×4	165	100	80	100	100	—	35	45
80C	SH80C-RT	10.5															
100C	SH100C-RT	13	415	365	385	435	25	25	M8×4	211	120	90	120	105	—	45	52
125C	SH125C-RT	24	460	365	385	560	88	48	M8×4	225	120	95	120	120	—	55	65
150C	SH150C-RT	24															
200C	SH200C-RT	29															
250C	SH250C-RT	29															
300C	SH300C-RT	53															
400C	SH400C-RT	53	604	474	515	690	64	58	M10×8	258	160	107	160	107	58	62	78
600C	SH600C-RT	115	973	870	800	950	75	50	M12×8	400	280	202	280	202	110	100	120

Notes:

- 1) *1 With plastic enclosure (Other frames: steel enclosure)
- 2) *2 With phase barrier as standard.

6 THERMAL OVERLOAD RELAYS

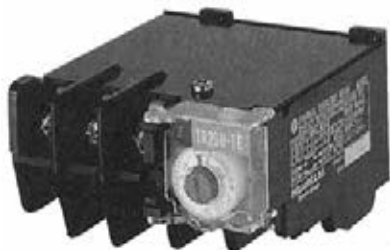

TR20B-1E

<Features>

- 1. IEC Standard Satisfied**
These thermal overload relays conform to the IEC Standard, and provide perfect motor protection.
- 2. Automatic and manual reset**
Automatic and manual reset can be easily set with a screwdriver.
- 3. Easy to Use**
All controls are located on the front.
A trip indicator is provided.

■ Type

- 1E Thermal Overload Relay...standard relay with overload protection
- 2E Thermal Overload Relay...relay with overload and single phasing protection (same size as 1E relay)

6.1 Construction

Internal Construction of 1E Thermal Overload Relay

Notes: Test trip shall be done by operating Test trip lever only, Trip indicator must not be operated.

Internal Construction of 2E Thermal Overload Relay
(External construction is exactly the same as the standard type)

<2E THERMAL OVERLOAD RELAY OPERATING MECHANISM>

The bending difference between on-phase and off-phase bimetals is available for protection of single phase failure.

Three phase action	Trip bar A, trip bar B and differential lever C move to the left as one unit as if they were one trip bar, and open the contact. This movement is same as that of the conventional thermal overload relay.
Single phase action	Trip bar B does not move due to the off-phase bimetal and trip bar A only moves to the left. At this movement, the differential lever C revolves counter-clock-wise and opens the contact.

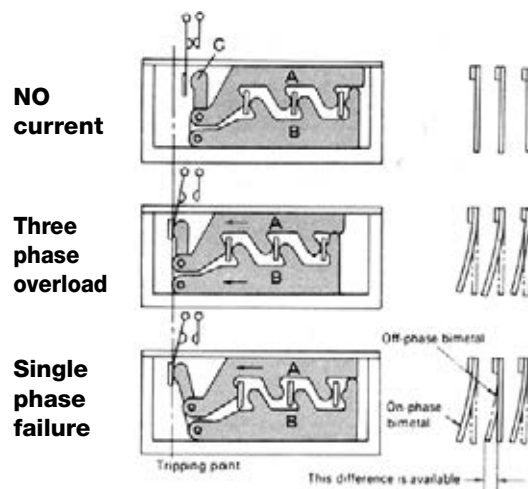

6.2 Tripping Characteristics

■ Standard (1E) Thermal Overload Relay

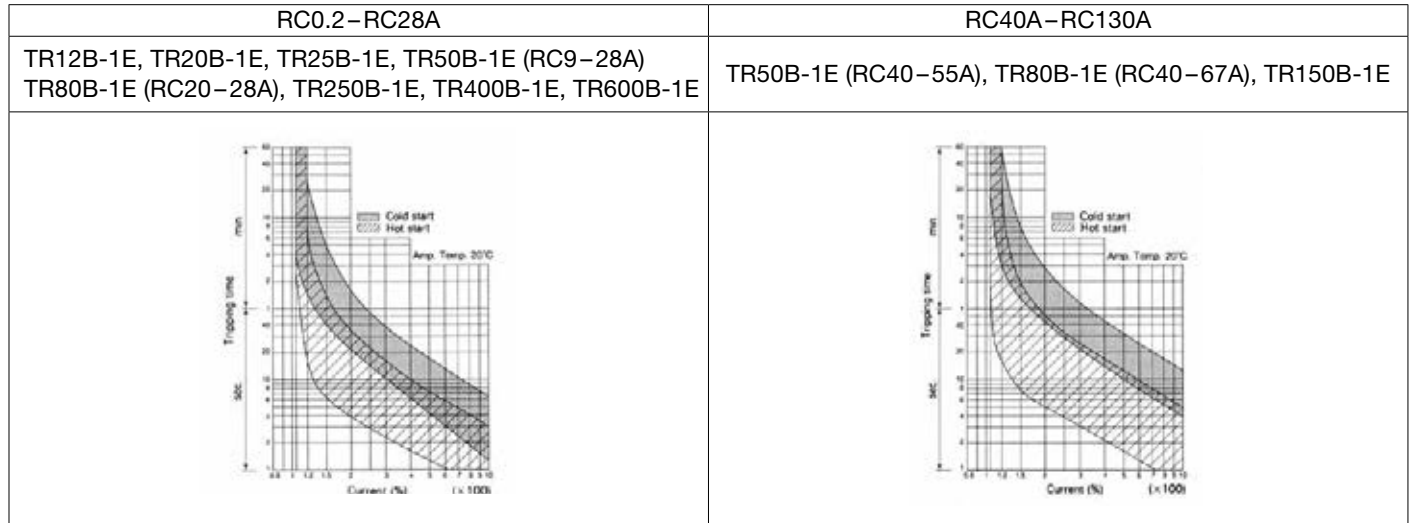

■ 2E Thermal Overload Relay

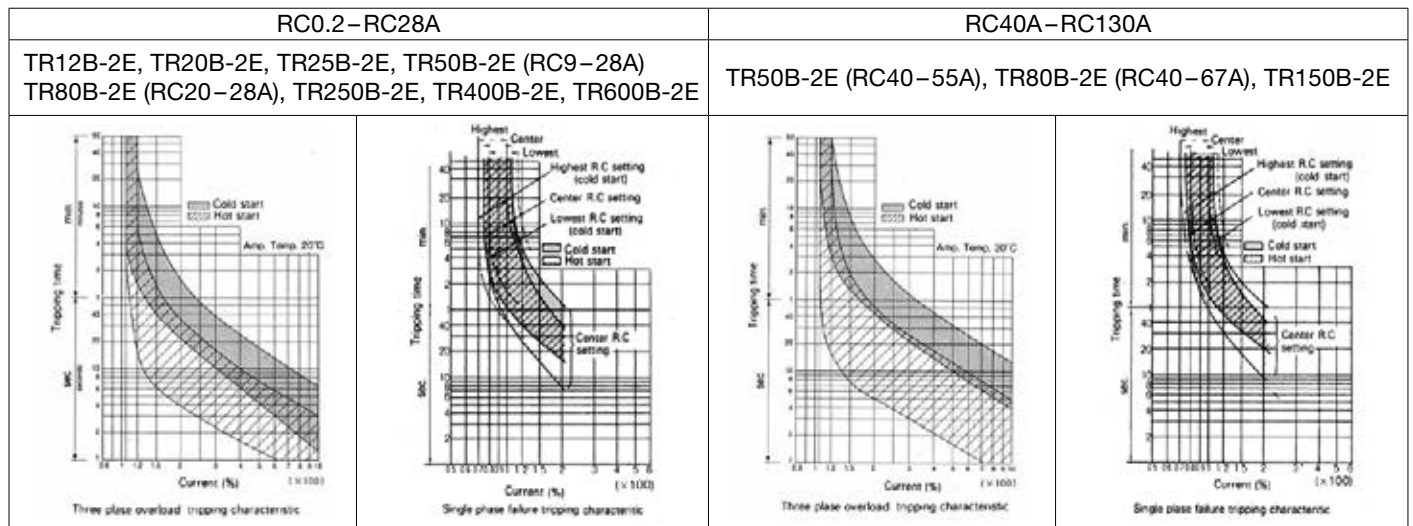

Cold Start: When overcurrent flows in a start where the thermal relay bimetals are not affected by current.

Hot Start: When overcurrent flows where the thermal relay bimetals are heated by current during motor running or restart.

■ Ambient Temperature Characteristics

The tripping characteristics are approximately constant under any ambient temperature so that compensating calculation is not necessary.

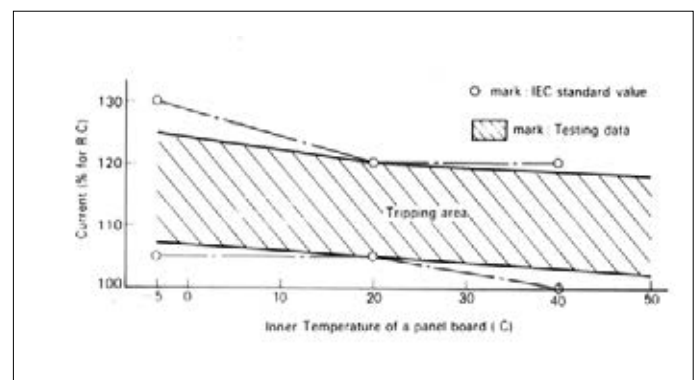

6.3 Application

■ Standard (1E) Thermal Overload Relay

HITACHI three phase squirrel-cage motor 4P for general purpose				Thermal overload relay		
500V 50Hz	400V 50Hz (60Hz)	380V 50Hz	200V 50Hz (60Hz)	RC (A)		Applicable range for each Model
				Center value	Adjustable range	
				0.2	0.16–0.24	TR12B-1E TR20B-1E
				0.3	0.22–0.38	
				0.5	0.38–0.62	
				0.8	0.6–1.0	
0.4kW 1.0A	0.4kW 1.1A (1.0A)	0.4kW 1.3A	0.2kW 1.2A (1.1A)	1.2	0.9–1.5	
0.75kW 1.5A			0.3kW 1.6A (1.5A)	1.4	1.1–1.8	
1.5kW 2.6A	0.75kW 1.9A (1.7A)	0.75kW 2.0A	0.4kW 2.3A (2.0A)	2.4	1.7–2.9	
2.2kW 3.7A	1.5kW 3.3A (3.0A)	1.5kW 3.5A	0.75kW 3.5A (3.2A)	3.8	2.8–4.4	
	2.2W 4.5A (4.2A)	2.2kW 4.8A		5	4–6	
3.7kW 5.8A	3.7kW 7.2A (7.0A)	3.7kW 7.5A	1.5kW 6.5A (6.0A)	6.8	5–8	
5.5kW 8.4A			2.2W 9.0A (8.5A)	9	7–11	TR25B-1E TR50B-1E
7.5kW 11.5A	5.5kW 11.5A (10.5A)	5.5kW 11A		11	9–13	
11kW 16A	7.5kW 14A (13.5A)	7.5kW 14.5A	3.7kW 14.5A (14A)	15	12–18	TR80B-1E
15kW 22A	11kW 20A (19.5A)	11kW 21A	5.5kW 23A (21A)	20	16–24	
				22	18–26	
18.5kW 27A	15kW 26A (26A)	15kW 28A	7.5kW 28A (27A)	28	22–34	
22kW 32A	18.5kW 34A (32A)	18.5kW 35A	11kW 42A (40A)	40	32–48	
30kW 42A	22kW 39A (37A)	22kW 42A		40	32–48	
				55	45–65	
37kW 52A	30kW 55A (52A)	30kW 55A	15kW 55A (52A)	55	45–65	
	37kW 68A (65A)	37kW 68A	18.5kW 68A (65A)	67	55–80	
	45kW 80A (80A)	45kW 85A	22kW 82A (78A)	80	65–95	
	55kW 98A (95A)	55kW 100A	30kW 110A (105A)	105	90–120	TR150B-1E
	75kW 130A (130A)		37kW 135A (130A)	130	110–150	
	90kW 160A (155A)		45kW 165A (160A)	1.4 (140)	(110–180)	TR20B-1E with CT (ratio 100:1)
	110kW 190A (185A)		55kW 195A (190A)	2.4 (140)	(170–290)	
	132kW 225A (220A)		75kW 260A (260A)	3.8 (380)	(280–440)	
			90kW 320A (310A)			
			110kW 380A (370A)			
			132kW 450A (440A)	5 (500)	(400–600)	TR250B-1E TR400B-1E TR600B-1E

Notes:

- 1) Be sure to adjust the setting current on the adjusting knob of the thermal overload relay to the rated current value (RC) of the motor employed (The setting current must be within indicated value.).
- 2) The figure in the parenthesis of center value (RC) is the current of primary side.

■ Standards for Thermal Overload Relay

The standard (1E) thermal overload relay and 2E thermal overload relay conform to the JIS, JEM and IEC standards in the table.

Standard	JIS C8201-4-1				JEM 1356				IEC 60947-4-1					
	Ambient temperature	Non-operation	Operation		Ambient temperature	Non-operation	Operation		Ambient temperature	Non-operation	Operation			
Overload relay operation	Standard type and 2E thermal overload relays	40°C	100%	120% within 2hours		40°C	100%	120% within 2hours		40°C	100%	120% within 2hours		
		20°C	105%	120% within 2hours		20°C	105%	120% within 2hours		20°C	105%	120% within 2hours		
		-5°C	105%	130% within 2hours		-5°C	105%	130% within 2hours		-5°C	105%	130% within 2hours		
		20°C	100%	150% within 2minutes (Class10A) within 4minutes (Class10) within 8minutes (Class20)		20°C	100%	200% within 2minutes		20°C	100%	150% within 2minutes (Class10A) within 4minutes (Class10) within 8minutes (Class20)		
		—	720% within 2–10seconds (Class10A) within 4–10seconds (Class10) within 6–10seconds (Class20)			—	200% within 2–30seconds			—	720% within 2–10seconds (Class10A) within 4–10seconds (Class10) within 6–10seconds (Class20)			
Phase-failure operation	Standard type thermal overload relays	—	—	—		20°C	3 elements 2 elements	100% 100% 100% (2 poles)	132% (2 poles only) 144% (1 pole only) 144% (1 pole only)	within 2 hours	20°C	105% (All poles)	1 pole 0% and 132% to balance poles	within 2 hours
		2E thermal overload relays	20°C	100% (2 poles) 90% (1 pole)	115% (2 poles) 0% (1 pole)	within 2 hours	20°C	90% (1 pole)	115% (2 poles) 0% (1 pole)		20°C	100% (2 poles) 90% (1 pole)	115% (2 poles) 0% (1 pole)	

Notes: Values (%) in the table indicate multiples against the rated current.

■ 2E Thermal Overload Relay

HITACHI three phase squirrel-cage motor 4P for general purpose				Thermal overload relay		
500V 50Hz	400V 50Hz (60Hz)	380V 50Hz	200V 50Hz (60Hz)	RC (A)		Applicable range for each type
				Center value	Adjustable range	
				0.2	0.16-0.24	TR12B-2E TR20B-2E
				0.3	0.24-0.36	
				0.4	0.32-0.48	
				0.5	0.4-0.6	
				0.6	0.5-0.7	
				0.8	0.7-0.9	
0.4kW 1.0A				1.0	0.8-1.2	
	0.4kW 1.1A (1.0A)	0.4kW 1.3A	0.2kW 1.2A (1.1A)	1.2	1.0-1.4	
0.75kW 1.5A			0.3kW 1.6A (1.5A)	1.4	1.1-1.7	
	0.75kW 1.9A (1.7A)			1.8	1.4-2.2	
1.5kW 2.6A		0.75kW 2.0A	0.4kW 2.3A (2.0A)	2.4	2.0-2.8	
				3.0	2.4-3.6	
2.2kW 3.7A	1.5kW 3.3A (3.0A)	1.5kW 3.5A	0.75kW 3.5A (3.2A)	3.8	3.0-4.5	
3.7kW 5.8A	2.2kW 4.5A (4.2A)	2.2kW 4.8A		5.0	4.0-6.0	
	3.7kW 7.2A (7.0A)	3.7kW 7.5A	1.5kW 6.5A (6.0A)	6.8	5.5-8.0	
5.5kW 8.4A			2.2kW 9.0A (8.5A)	9.0	7.0-11	
7.5kW 11.5A	5.5kW 11.5A (10.5A)	5.5kW 11A		11	9-13	
11kW 16A	7.5kW 14A (13.5A)	7.5kW 14.5A	3.7kW 14.5A (14A)	15	12-18	
15kW 22A	11kW 20A (19.5A)	11kW 21A	5.5kW 23A (21A)	20	16-24	
				22	18-26	
18.5kW 27A	15kW 26A (26A)	15kW 28A	7.5kW 28A (27A)	28	22-34	
22kW 32A	18.5kW 34A (32A)	18.5kW 35A	11kW 42A (40A)	40	32-48	
30kW 42A	22kW 39A (37A)	22kW 42A		40	32-48	
				55	45-65	
37kW 52A	30kW 55A (52A)	30kW 55A	15kW 55A (52A)	55	45-65	
	37kW 68A (65A)	37kW 68A	18.5kW 68A (65A)	67	55-80	
	45kW 80A (80A)	45kW 85A	22kW 82A (78A)	80	65-95	
	55kW 98A (95A)	55kW 100A	30kW 110A (105A)	105	90-120	
	75kW 130A (130A)		37kW 135A (130A)	130	110-150	
	90kW 160A (155A)		45kW 165A (160A)	1.4 (140)	(110-170)	
	110kW 190A (185A)		55kW 195A (190A)	1.8 (180)	(140-220)	
	132kW 225A (220A)		75kW 260A (260A)	2.4 (240)	(200-280)	
			90kW 320A (310A)	3.0 (300)	(240-360)	
			110kW 380A (370A)	3.8 (380)	(300-450)	
			132kW 450A (440A)	5 (500)	(400-600)	

Notes:

- 1) Be sure to adjust the setting current on the adjusting knob of the thermal overload relay to the rated current value (RC) of the motor employed (The setting current must be within indicated value).
- 2) The figure in the parenthesis of center value (RC) is the current of primary side.





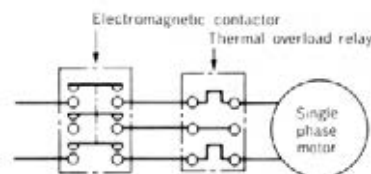



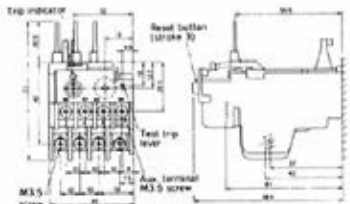

■ Application for Single-phase Motor

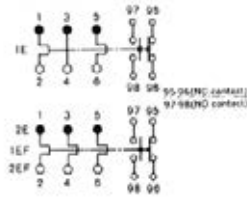
Single-phase motor 100V		Standard type (1E) thermal overload relay			Thermal overload relay application method	
Capacity (kW)	Hitachi single-phase motor current (A) (Reference)	Thermal overload relay RC value (A)		Type application range		
		Center value	Setting current width			
0.035	1.2-1.4	1.4	1.1-1.8	TR12B-1E (RC 1.4-11.4) TR20B-1E (RC 1.4-15A)		
0.065	2.2-2.5	2.4	1.7-2.9			
0.1	3.0-3.8	3.8	2.8-4.4			
0.2	4.1-6.3	6.8	5.8			
0.25	5.4-6.7					
0.3	6.4-7.1	9	7-11			
0.4	5.8-9.6					
0.55	8-9.5					
0.75	10.5-15.5	11	9-13			
		15	12-18			

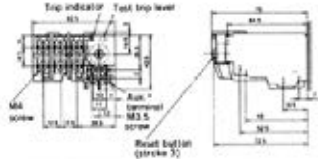
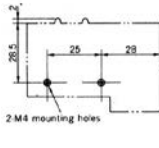
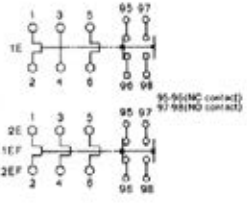

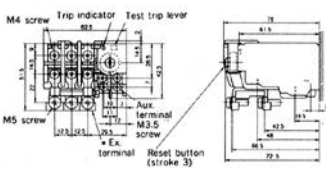
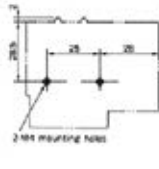
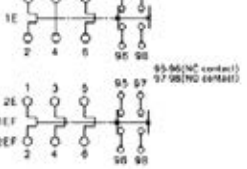
Notes: Set the current value of the thermal overload relay with adjusting knob after confirming the current of the applying motor.

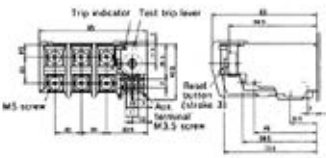
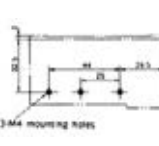
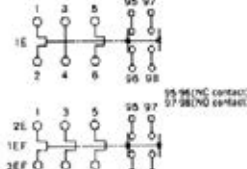

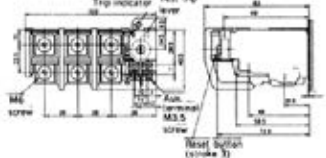
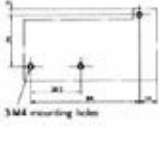
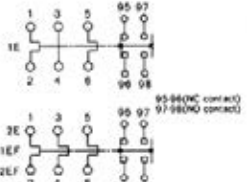

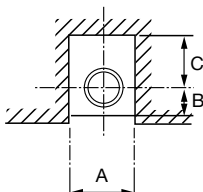

6.4 Appearance and Dimensions

Appearance	Dimensions (mm) (Product mass)	Drilling plan	Contact arrangement	Terminal section dimensions (mm)		
 <p>TR12B-1E TR12B-2E TR12B-1EF TR12B-2EF</p>	 <p>(0.1kg)</p>			Main circuit	Terminal screw	M3.5
					Terminal dimensions	A
B	6					
C	4.5					
Main circuit	Operating circuit	Terminal screw	M3.5	Terminal dimensions	A	7.8
					B	4
C	4.5					
 <p>TR20B-1E TR20B-2E TR20B-1EF TR20B-2EF</p>	 <p>(0.15kg)</p>	 <p>2-M4 mounting holes</p>		Main circuit	Terminal screw	M4
					Terminal dimensions	A
B	5 (7.4)					
C	5 (5)					
Main circuit	Operating circuit	Terminal screw	M3.5	Terminal dimensions	A	7.8
					B	4
C	4.5					
 <p>TR25B-1E TR25B-2E TR25B-1EF TR25B-2EF</p>	 <p>(0.17kg)</p>	 <p>2-M4 mounting holes</p>		Main circuit	Terminal screw	M5 (M4)
					Terminal dimensions	A
B	6 (7.4)					
C	8.5 (5)					
Main circuit	Operating circuit	Terminal screw	M3.5	Terminal dimensions	A	7.8
					B	4
C	4.5					
 <p>TR50B-1E TR50B-2E TR50B-1EF TR50B-2EF</p>	 <p>(0.25kg)</p>	 <p>3-M4 mounting holes</p>		Main circuit	Terminal screw	M5
					Terminal dimensions	A
B	6.5 (10)					
C	7 (7)					
Main circuit	Operating circuit	Terminal screw	M3.5	Terminal dimensions	A	7.8
					B	4
C	4.5					
 <p>TR80B-1E TR80B-2E TR80B-1EF TR80B-2EF</p>	 <p>(0.36kg)</p>	 <p>3-M4 mounting holes</p>		Main circuit	Terminal screw	M6
					Terminal dimensions	A
B	8.5 (10.5)					
C	8 (9)					
Main circuit	Operating circuit	Terminal screw	M3.5	Terminal dimensions	A	7.8
					B	4
C	4.5					

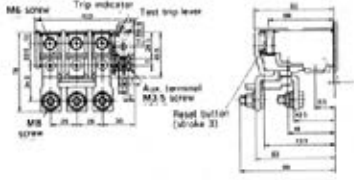
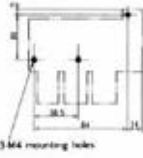
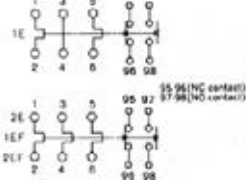
Terminal section dimensions

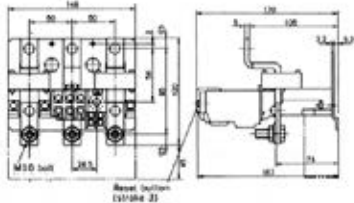
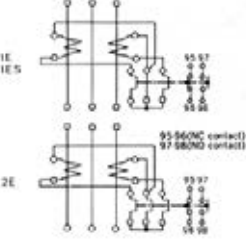
Values shown in parenthesis in the main circuit terminal dimensions are values of the power side.

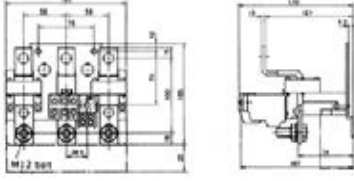
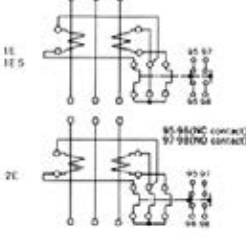

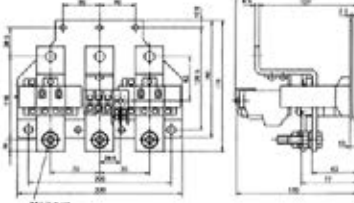
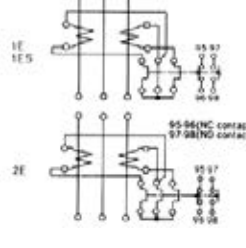
Appearance	Dimensions (mm) (Product mass)	Drilling plan	Contact arrangement	Terminal section dimensions (mm)										
 <p>TR150B-1E TR150B-2E TR150B-1EF TR150B-2EF</p>	 <p>(0.37kg)</p>	 <p>3 M4 mounting holes</p>		<table border="1"> <tr> <td rowspan="3">Main circuit</td> <td>Terminal screw</td> <td>M8 (M6)</td> </tr> <tr> <td rowspan="3">TR150B-2E</td> <td>A</td> <td>22 (16.5)</td> </tr> <tr> <td>B</td> <td>8 (10.5)</td> </tr> <tr> <td>C</td> <td>11 (9)</td> </tr> </table>	Main circuit	Terminal screw	M8 (M6)	TR150B-2E	A	22 (16.5)	B	8 (10.5)	C	11 (9)
				Main circuit		Terminal screw	M8 (M6)							
TR150B-2E	A	22 (16.5)												
	B	8 (10.5)												
	C	11 (9)												
<table border="1"> <tr> <td rowspan="3">Operating circuit</td> <td>Terminal screw</td> <td>M3.5</td> </tr> <tr> <td rowspan="3">Terminal dimensions</td> <td>A</td> <td>7.8</td> </tr> <tr> <td>B</td> <td>4</td> </tr> <tr> <td>C</td> <td>4.5</td> </tr> </table>	Operating circuit	Terminal screw	M3.5	Terminal dimensions	A	7.8	B	4	C	4.5				
Operating circuit		Terminal screw	M3.5											
		Terminal dimensions	A		7.8									
	B		4											
C	4.5													
 <p>TR250B-1E TR250B-2E TR250B-1ES</p>	 <p>(2.0kg)</p>	<p>For mounting to H200, H250</p>		<table border="1"> <tr> <td rowspan="3">Main circuit</td> <td>Terminal screw</td> <td>M10 bolt</td> </tr> <tr> <td rowspan="3">Terminal dimensions</td> <td>A</td> <td>37</td> </tr> <tr> <td>B</td> <td>12.5</td> </tr> <tr> <td>C</td> <td>16</td> </tr> </table>	Main circuit	Terminal screw	M10 bolt	Terminal dimensions	A	37	B	12.5	C	16
				Main circuit		Terminal screw	M10 bolt							
Terminal dimensions	A	37												
	B	12.5												
	C	16												
<table border="1"> <tr> <td rowspan="3">Operating circuit</td> <td>Terminal screw</td> <td>M3.5</td> </tr> <tr> <td rowspan="3">Terminal dimensions</td> <td>A</td> <td>7.8</td> </tr> <tr> <td>B</td> <td>4</td> </tr> <tr> <td>C</td> <td>4.5</td> </tr> </table>	Operating circuit	Terminal screw	M3.5	Terminal dimensions	A	7.8	B	4	C	4.5				
Operating circuit		Terminal screw	M3.5											
		Terminal dimensions	A		7.8									
	B		4											
C	4.5													
 <p>TR400B-1E TR400B-2E TR400B-1ES</p>	 <p>(2.0kg)</p>	<p>For mounting to H300, H400</p>		<table border="1"> <tr> <td rowspan="3">Main circuit</td> <td>Terminal screw</td> <td>M12 bolt</td> </tr> <tr> <td rowspan="3">Terminal dimensions</td> <td>A</td> <td>44</td> </tr> <tr> <td>B</td> <td>15</td> </tr> <tr> <td>C</td> <td>20</td> </tr> </table>	Main circuit	Terminal screw	M12 bolt	Terminal dimensions	A	44	B	15	C	20
				Main circuit		Terminal screw	M12 bolt							
Terminal dimensions	A	44												
	B	15												
	C	20												
<table border="1"> <tr> <td rowspan="3">Operating circuit</td> <td>Terminal screw</td> <td>M3.5</td> </tr> <tr> <td rowspan="3">Terminal dimensions</td> <td>A</td> <td>7.8</td> </tr> <tr> <td>B</td> <td>4</td> </tr> <tr> <td>C</td> <td>4.5</td> </tr> </table>	Operating circuit	Terminal screw	M3.5	Terminal dimensions	A	7.8	B	4	C	4.5				
Operating circuit		Terminal screw	M3.5											
		Terminal dimensions	A		7.8									
	B		4											
C	4.5													
 <p>TR600B-1E TR600B-2E TR600B-1ES</p>	 <p>(5.0kg)</p>			<table border="1"> <tr> <td rowspan="3">Main circuit</td> <td>Terminal screw</td> <td>M12 bolt</td> </tr> <tr> <td rowspan="3">Terminal dimensions</td> <td>A</td> <td>55</td> </tr> <tr> <td>B</td> <td>16</td> </tr> <tr> <td>C</td> <td>28</td> </tr> </table>	Main circuit	Terminal screw	M12 bolt	Terminal dimensions	A	55	B	16	C	28
				Main circuit		Terminal screw	M12 bolt							
Terminal dimensions	A	55												
	B	16												
	C	28												
<table border="1"> <tr> <td rowspan="3">Operating circuit</td> <td>Terminal screw</td> <td>M3.5</td> </tr> <tr> <td rowspan="3">Terminal dimensions</td> <td>A</td> <td>7.8</td> </tr> <tr> <td>B</td> <td>4</td> </tr> <tr> <td>C</td> <td>4.5</td> </tr> </table>	Operating circuit	Terminal screw	M3.5	Terminal dimensions	A	7.8	B	4	C	4.5				
Operating circuit		Terminal screw	M3.5											
		Terminal dimensions	A		7.8									
	B		4											
C	4.5													

Notes:

1) Changing Reset Method

Normally, relay is set in manual reset.

The change to automatic reset is done easily as shown in the following diagram.

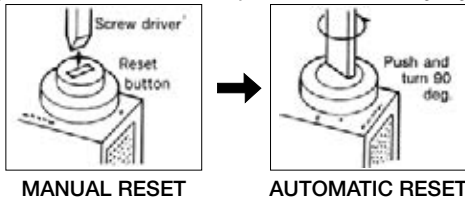

2) Opening Cover for Current Adjusting Knob

Turn protection cover by pulling up the projection with a finger.

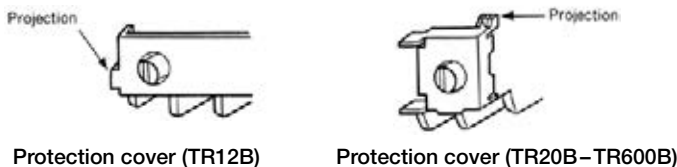

7. ELECTROMAGNETIC SWITCHES WITH 2E THERMAL OVERLOAD RELAY (OVERLOAD AND PHASE-FAILURE PROTECTION)



HS20-TK

The 2E thermal overload relay has the following features in comparison to the conventional semiconductor type 2E relay.

<Features>

1. The size has been drastically reduced so that the mounting area is only about 40% and the weight about 30% of the conventional 2E relay.
2. Price has also been drastically reduced to about 40%.
3. Mounting and wiring have been facilitated.

ELECTROMAGNETIC CONTACTOR

The electromagnetic contactor which has high efficiency and long life is used.

2E THERMAL OVERLOAD RELAY

With this design, a sensitive phase-failure protection function has been added to the 3-element thermal overload relay. It is the smallest thermal overload relay available. Besides this, it possesses stabilized characteristics features and many merits such as independent installation capability, handling convenience, safety, etc.

7.1 Phase-Failure Protection Effect of 2E Thermal Overload Relays

In case of smaller capacity motors, 3-element thermal overload relay can protect the motor from burn-out due to phase-failure operation.

However, since motors above medium capacity have a tendency that due to the rotor construction, the temperature rises remarkably at time of phase-failure, 1E thermal overload relay cannot protect the motor.

Nevertheless, when the 2E thermal overload relay is used even in such a case, protection at time of phase-failure can be ensured as it will operate before the motor temperature becomes high, as shown in the table below, by the action of the built-in differential phase-failure detection mechanism (Please refer to page 37: the principle of the differential phase-failure detection mechanism.).

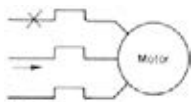
Operation	Thermal overload relay	Motor capacity (200V, kW)	Temperature rise of motor at thermal overload relay operation		
			0.5	1	1.5
Three-phase 	1E or 2E thermal overload relay	0.2-132	*The temperature rise at three-phase overload operation of each motor is made 1.		
Phase-failure 	1E thermal overload relay	0.75	[Bar chart showing temperature rise > 1.5]		
		3.7	[Bar chart showing temperature rise > 1.5]		
		11	[Bar chart showing temperature rise > 1.5]		
		55	[Bar chart showing temperature rise > 1.5]		
		132	[Bar chart showing temperature rise > 1.5]		
	1E thermal overload relay	0.75	[Bar chart showing temperature rise < 1.5]		
		3.7	[Bar chart showing temperature rise < 1.5]		
		11	[Bar chart showing temperature rise < 1.5]		
		55	[Bar chart showing temperature rise < 1.5]		
		132	[Bar chart showing temperature rise < 1.5]		

The 2E thermal overload relay operates before the motor temperature becomes high.

7.2 Appearance and Dimensions

Since dimensions are the same as the standard type electromagnetic switch (those without K at the end), see pages 31 to 34 for non-reversible type frames without enclosure and page

35 for reversible type frames without enclosure. Moreover see page 36 for frames with enclosure.

8. DC OPERATED ELECTROMAGNETIC CONTACTORS

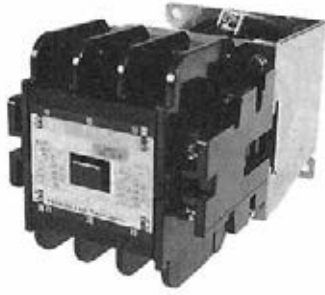

H35-G

<Features>

1. The compact design drastically reduces the mounting space to the control panel.
2. DC exciting type is noiseless.
3. Direct input type without external resistors for models up to 65C frame.

8.1 Operating Principle of Double Coil

<p>H80C-G-H125C-G</p> <p>Remarks: C.C.: Closing coil H.C.: Holding coil</p>	<p>The double coil is a coil which has 2 coils, closing coil CC and holding coil HC are wound on the coil bobbin. In explaining the operation by the left diagram circuit, it becomes as below.</p> <p>(1) When BSa is closed, current flows as $(\oplus) \rightarrow BSS \rightarrow BSa \rightarrow 52NC \rightarrow CC \rightarrow (\ominus)$ and only CC coil is excited and picked up.</p> <p>(2) When picked up, the changeover NC contact opens, and current flows as $(\oplus) \rightarrow BSS \rightarrow 52NO \rightarrow HC \rightarrow CC \rightarrow (\ominus)$ and both coils of HC and CC are excited. After pick-up, the internal resistance of HC is large in comparison to that of CC so current decreases and watt loss of the coil is reduced.</p>	<p>H150C-G-H800C-G</p> <p>Change between closing coil (CC) and holding coil (HC) is controlled by the provided control circuit.</p>
---	--	---

8.2 Dimensions

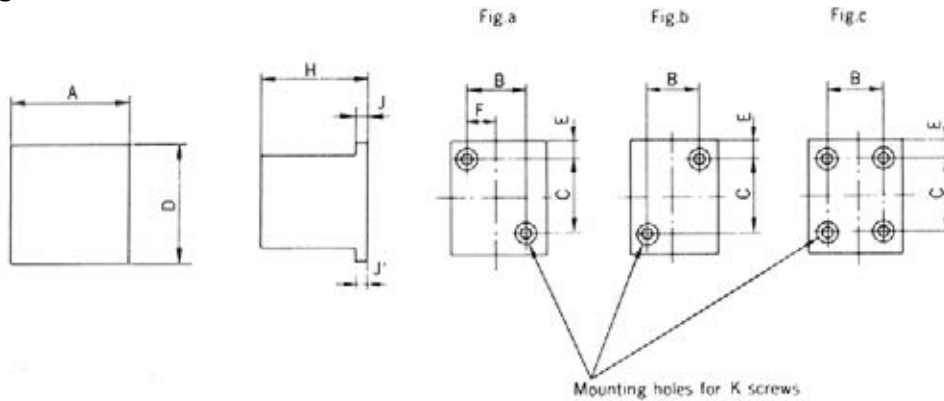

Model	Dimension (mm)				Drilling plan (mm)						Mass (kg)
	A	D	H	J (J')	Fig.	B	C	E	F	K	
H10-G	44	65	108	2.3	a	33	55	5	17	2-M4	0.5
H11-G	53	65	108	2.3	a	33	55	5	17	2-M4	0.58
H20-G	64	70	123	2.3	a	54	59	5.5	—	2-M4	1.02
H25-G	64	100	123	2.3	a	54	59	20.5	—	2-M4	1.08
H35-G H50-G	82	90	128.5	2.3	a	71	65	12.5	—	2-M4	1.7
H65C-G	88	106	147	2.3	a	71	65	20.5	—	2-M4	2.1
H80C-G H100C-G H125C-G	100 *(124)	136	154	17.5	b	84	110	13	—	2-M5	2.2
H150C-G	120 *(144)	153	165	17	b	100	130	11.5	—	2-M6	3.3
H200C-G H250C-G	138 *(162)	230	191	2.3	c	50	210	10	—	4-M8	5.5
H300C-G H400C-G	187 **(199)	240	225	3.2	c	60	220	10	—	4-M8	9.7
H600C-G	284	316	232	3.2	c	170	222	46	—	4-M10	22

Notes: * Auxiliary contacts 4N03NC ** Auxiliary contacts 4N04NC

9. LATCHED ELECTROMAGNETIC CONTACTORS

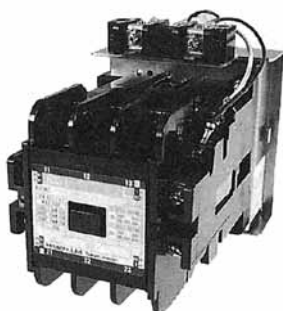

H35-L

<Features and Applications>

1. After the contact has been closed, the contactor has kept been in closed position mechanically, so that it cannot be released due to service interruption, momentary service interruption, voltage drop, etc. This contactor is most suitable such important circuits or memory circuits related to chemical plants, spinning machines, etc. which must be protected against its release particularly due to momentary service interruption or voltage drop.
2. Capable of being remote-controlled, and at ordinary times, free from power consumption of coil or humming. Ideal applications of the contactor are to distribution board circuits for facilities of buildings like hospitals, supermarkets, etc., automatic control circuits of street lights, motor load of display show-cases, etc. which are not often switched on and off or are continuously used for a long time.
3. In case of the reversible type, one with mechanical interlock can be manufactured. This is suitable for emergency power source changeover.
4. Self cut-off contact is equipped for both closing and tripping coils.
5. In an emergency, manual break is possible.

9.1 Explanation of Operation

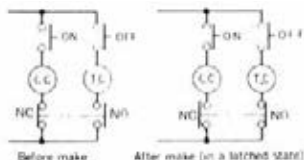

Explanation of Operation:

ON: Making by means of excitation of CC, which can be held mechanically. After making, the contact NO is in "ON" state, and the contact NC is in "OFF" state.

OFF: Releasing by means of excitation of TC. After release, the contact NO returns to "OFF", and the contact NC, to "ON". The contacts NO and NC are built in.

Notes: The ON and OFF contacts should be interlocked.

9.2 Dimensions

■ Non-reversible type

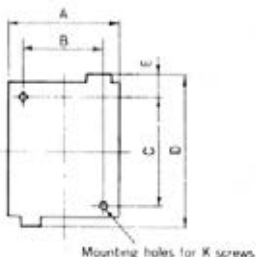

H10-L-H65C-L

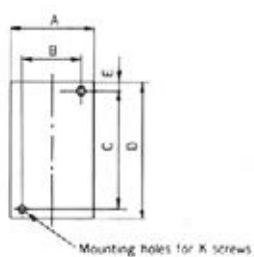

H80C-L-H150C-L

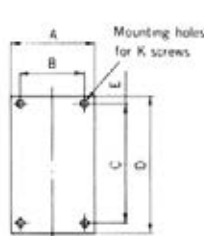

H200C-L-H600C-L

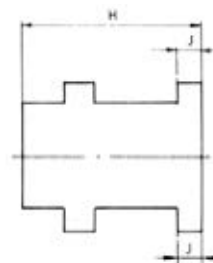

Model	Dimension (mm)								Mass (kg)
	A	B	C	D	E	H	J (J')	K	
H10-L	49	33	55	65	5	130	10	M4 X 2	0.4
H11-L	55	33	55	65	5	130	10	M4 X 2	0.42
H20-L	72	54	59	108 (122)	33.5 (47.5)	127	42	M4 X 2	0.85
H25-L	72	54	59	113 (127)	33.5 (47.5)	127	42	M4 X 2	0.9
H35-L	88	71	65	116 (130)	34.5 (48.5)	139	45	M4 X 2	1.2
H50-L	91	70	65	127 (141)	34.5 (48.5)	145	44	M4 X 2	1.65
H80C-L	107	84	110	153 (154)	25.5 (26.5)	188	51	M5 X 2	2.7
H100C-L									
H125C-L									
H150C-L	134	100	130	194	43.5	201	53	M6 X 2	4.0
H200C-L	154	115	185	235	30	225	36	M8 X 4	8.0
H250C-L									
H300C-L	170	60	320	340	10	227	5.5	M8 X 4	11.7
H400C-L									
H600C-L	270	170	322	389	46	235	7.7 (5.5)	M10 X 4	28.0

Notes: () DC operated Model H□□□-LG.

■ Reversible type

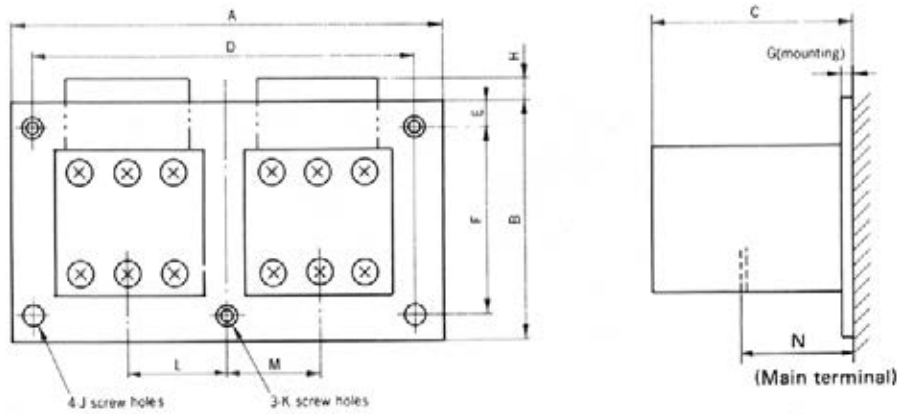

Model	Dimension (mm)													Mass (kg)
	A	B	C	D	E	F	G	H	J	K	L	M	N	
H11-RL	120	90	135	90	7.5	75	1.2	—	M4	—	31	33	71	1.0
H20-RL	172	110	133	155	5	100	1.6	— (13.5)	M4	—	41	41	95	2.0
H25-RL	172	110	133	155	5	100	1.6	— (13.5)	M4	—	41	41	*96, 76	2.1
H35-RL H50-RL	200	120	144	185	7.5	105	1.6	2 (16)	M5	—	53.5	47.5	106	2.7
H65C-RL	200	120	151	185	7.5	105	1.6	2 (16)	M5	—	53.5	53.5	107	3.6
H80C-RL H100C-RL H125C-RL	240	170	194	220	10	150	1.6	—	—	M6	59.5	59.5	125	6.1
H150C-RL	280	226	207	260	10	206	2.3	—	—	M6	76.5	62.5	139	10
H200C-RL H250C-RL	330	290	232	300	15	620	3.2	—	—	M8	78.5	78.5	143	19
H300C-RL H400C-RL	360	380	251	320	10	360	9.2	—	M8	—	94	94	147	26
H600C-RL	540	413	258	480	18	378	25	—	M10	—	135	135	163	67

- Notes:
 1) () DC operated Model H□□□-RLG.
 2) *96 R, T, U, W phase
 76 S, V phase

10. AUTOMATIC STAR-DELTA STARTERS (3-CONTACTORS TYPE)

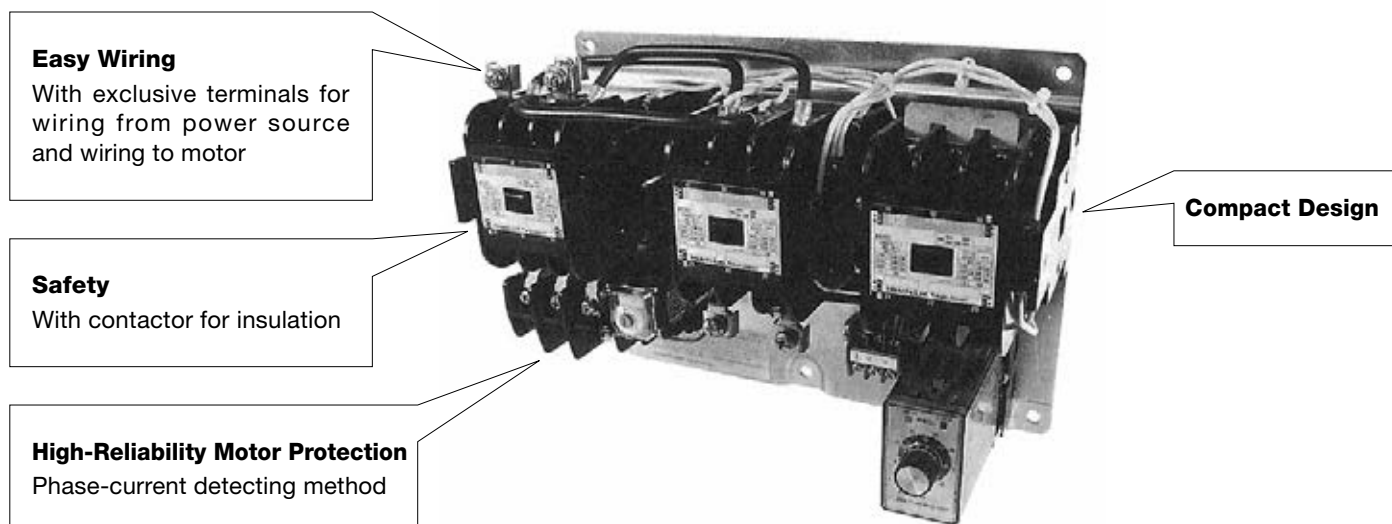

Easy Wiring

With exclusive terminals for wiring from power source and wiring to motor

Safety

With contactor for insulation

High-Reliability Motor Protection

Phase-current detecting method

Compact Design

10.1 Ratings and Specifications

Voltage	Frame	Model		Motor capacity (AC3) (kW)	Components				
		Without enclosure	With enclosure		Contactor		Thermal overload relay		
					Insulation operation	Starting	Model	RC (A)	Adjustable range
200–220V	5	Y-5	SY-5	5.5	H20	H20	TR20B-2E	15	12–18
	7	Y-7	SY-7	7.5	H25	H20	TR20B-2E	15	12–18
	11	Y-11	SY-11	11	H35	H20	TR50B-2E	28	22–34
	15	Y-15	SY-15	15	H50	H25	TR50B-2E	28	22–34
	19	Y-19	SY-19	18.5	H50	H35	TR50B-2E	40	32–48
	22	Y-22	SY-22	22	H65C	H35	TR80B-2E	55	45–65
	30	Y-30	SY-30	30	H80C	H50	TR80B-2E	67	55–80
	37	Y-37	SY-37	37	H100C	H65C	TR150B-2E	80	65–95
	45	Y-45	SY-45	45	H125C	H65C	TR150B-2E	80	65–95
	55	Y-55	SY-55	55	H150C	H80C	TR150B-2E	105	90–120
	75	Y-75	SY-75	75	H200C	H125C	TR250B-2E	1.4 (140)	(110–170)
380–440V	11	Y4-11	SY4-11	11	H20	H20	TR20B-2E	9	7–11
	15	Y4-15	SY4-15	15	H25	H20	TR20B-2E	15	12–18
	19	Y4-19	SY4-19	18.5	H35	H25	TR50B-2E	20	16–24
	22	Y4-22	SY4-22	22	H50	H35	TR50B-2E	20	16–24
	30	Y4-30	SY4-30	30	H50	H35	TR50B-2E	28	22–34
	37	Y4-37	SY4-37	37	H65C	H50	TR80B-2E	40	32–48
	45	Y4-45	SY4-45	45	H65C	H65C	TR80B-2E	40	32–48
	55	Y4-55	SY4-55	55	H80C	H65C	TR80B-2E	55	45–65
	75	Y4-75	SY4-75	75	H100C	H80C	TR150B-2E	80	65–95
	90	Y4-90	SY4-90	90	H125C	H100C	TR150B-2E	80	65–95
	110	Y4-110	SY4-110	110	H150C	H125C	TR150B-2E	105	90–120

Notes:

- 1) Set thermal overload relay to the figure – rated current of motor x 0.58 – before operation.
- 2) Timer is set at 10 seconds, do not set at more than 15 seconds to prevent mal-operation of thermal overload relay at starting.
- 3) When using a 400V class star-delta starter at the operating voltage of 400 V, the starter should be a lock-up circuit using a push button. For an automatic operation using a sequencer or the like, change the operation circuit voltage to 200 or 100 V.

10.2 Connection Diagram

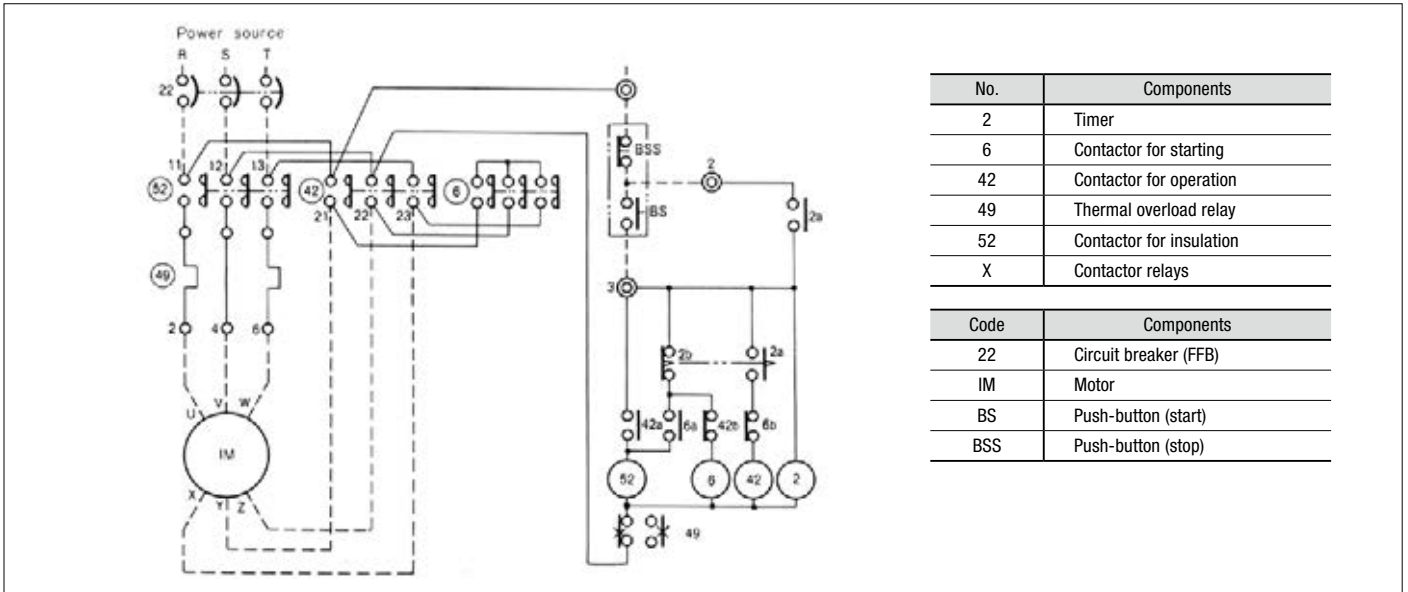

10.3 Dimensions

(1) Without enclosure

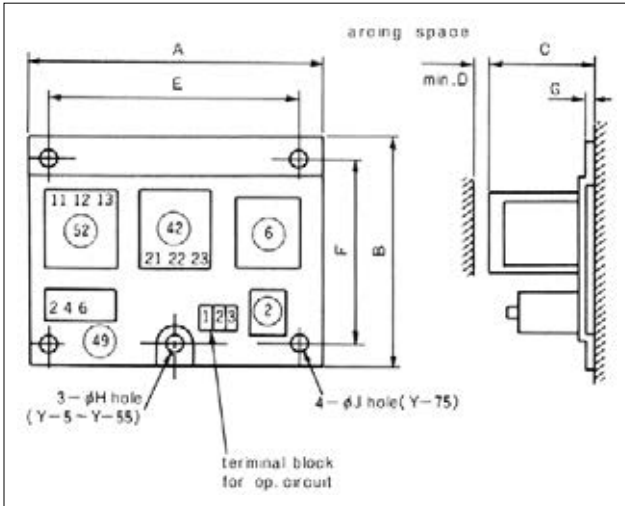

() In case of switch of 380–440V

Frame	220–240V	380–440V	Dimensions (mm)				Drilling plan (mm)					Mass (kg)	
			A	B	C	D	E	F	G	H	J		
5.5	11												2.5 (3.8)
7.5	15		240	181 (200)	102 (101)	0	220	150	1.6	7	—		4.2 (5.2)
11	18.5												4.5 (5.4)
15	22												5.5 (6.5)
18.5	30		280	200 (235)	114 (112)	0	260	180	200 (235)	7	—		4.5 (5.4)
22	37												5.5 (6.5)
30	45												8.5 (10)
37	55		330	290	123 (122)	1	300	260	290	9	—		9 (10.5)
45	75												11 (12.5)
—	90		370	300	161 (124)	1	340	270	300	9	—		12 (13.5)
55	110												12 (13.5)
75	—		460	380	172	1	430	350	380	—	9		22

(2) With enclosure

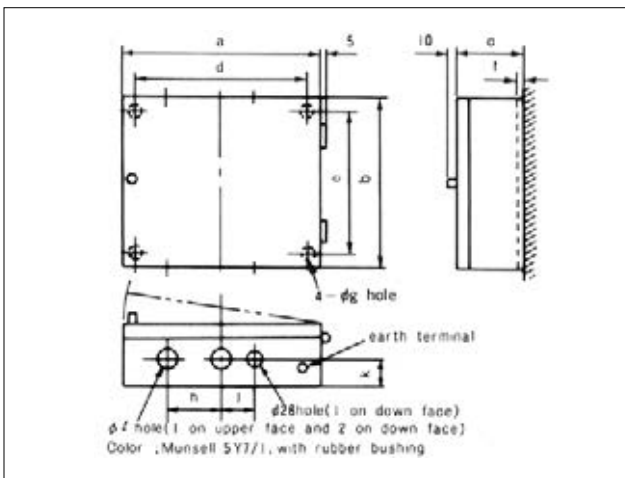

Frame	220–240V	380–440V	Dimensions (mm)				Drilling plan (mm)						Mass (kg)	
			a	b	c	d	e	f	g	h	j	k		l
5.5	11													6.8 (8.1)
7.5	15		270	270	150	200	230	1.6	6	80	40	70	28	9.7 (10.7)
11	18.5													10 (10.9)
15	22													11 (12)
18.5	30		320	320	150	250	250	1.6	7	100	60	80	42	10 (10.9)
22	37													11 (12)
30	45													16.3 (17.8)
37	55		370	400	180	300	350	1.6	9	100	70	90	42	16.8 (18.3)
45	75													21.5 (23.0)
—	90		420	500	190	350	400	1.6	9	120	90	100	64	22.5 (24.0)
55	110													22.5 (24.0)
75	—		520	570	230	400	450	1.6	9	170	100	100	64	36.5

Notes: For switches with enclosure, push-buttons and/or pilot lights can be supplied on request.

11. CONTACTOR RELAYS



XS4

<Features>

1. Self-Up Screw

All models employ Hitachi's exclusive "self-up" screws with a seat for easy wiring.

2. High Reliability

Since the XS4 employs highly-reliable twin contacts as standard, a minimum application load of 20V 5mA is made possible.

3. Enhanced Auxiliary Contact Unit

The XS4 can have up to 8 contacts by mounting the auxiliary contact unit. The head-on unit and the side-on unit cannot be mounted on the same body at the same time.

11.1 Application for the International Standards

Rated insulation voltage (V)	IEC 60947-4-1	NEMA	BS	VDE	UL	CSA
150	All Frames	All Frames	All Frames	All Frames	Authorization is required.	
250						
300						
380		/		All Frames	/	/
500						
600						
660, 690						

11.2 Coil Ratings

■ Standard type (AC operation)

Designation	Rated operational voltage	Color of coil outer wrapping	Terminal code
100 VAC	100V 50Hz/100 – 110V 60Hz	Yellow	
200 VAC	200V 50Hz/200 – 220V 60Hz	White	
400 VAC	380 – 400V 50Hz/400 – 440V 60Hz	Red	
100 VAC	Can be made within the range of 24V – 550V of other than those above.	Blue	

Notes: The latch's pick-up and tripping coil is of 30 seconds rating for both AC operation and DC operation.

11.3 Contact Arrangement Diagram

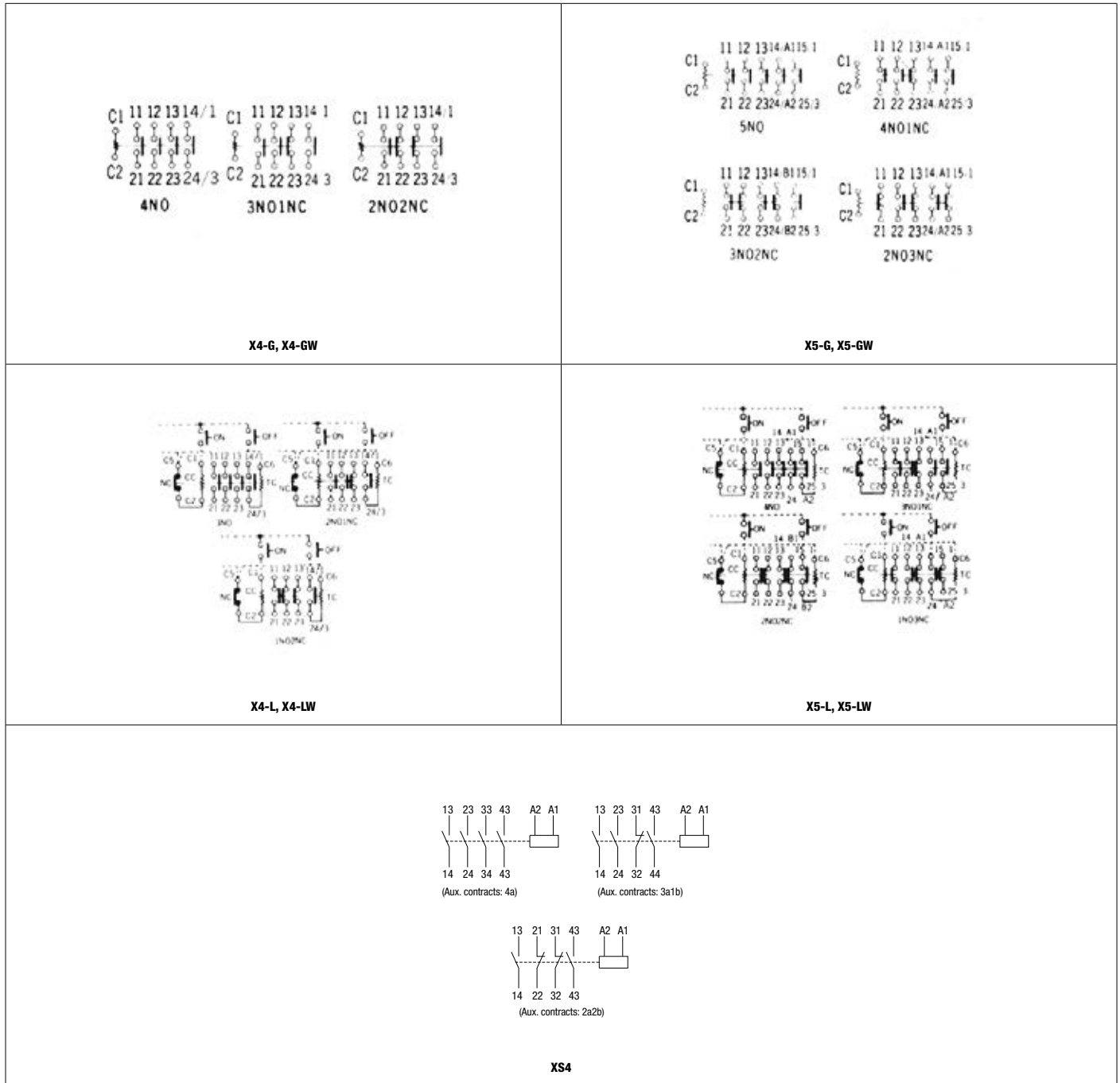

11.4 Dimensions and Mass

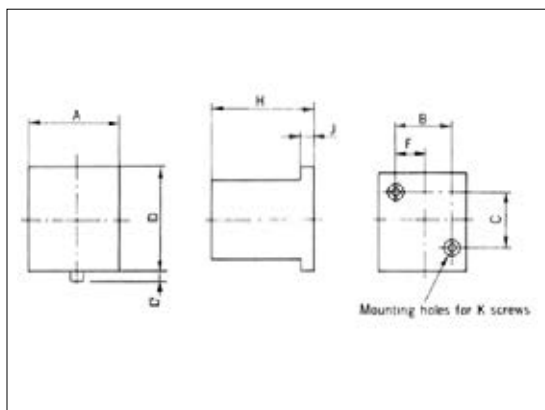



Model	Dimension (mm)				Drilling plan (mm)				Mass (kg)
	A	D (D')	H	J	B	C	F	K	
X4G, X4-GW	44	65	107	2.3	33	55	17	2-M4	0.54
X5G, X5-GW	53	65	108	2.3	33	55	17	2-M4	0.57
X4-L, X4-LW	49	65	130	10	33	55	16.5	2-M4	0.4
X5-L, X5-LW	55	65	130	10	33	55	16.5	2-M4	0.42
XS4	43	80	81	11	33	55	17.5	2-M4	0.34

12. OPTIONS

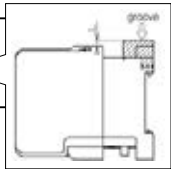
12.1 Aux. Contact Block, Safety Cover and Mechanical Interlock Unit

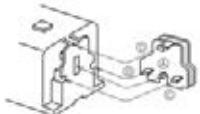
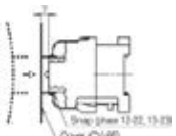
HS series						
Item	Model	Configuration	Rating	Applicable model		Mounting
Auxiliary contact block	SXS-2	Contact configuration 1a1b	Rated operational current (AC15) 220V 3A 440V 1.5A Open thermoelectric current (Ith) 10A	XS4 HS8-50		Assemble the unit referring to the instruction manual that comes with the unit.
	SXH-2	Contact configuration 2a 1a1b 2b				
	SXH-4	Contact configuration 4a 3a1b 2a2b				
Coil surge absorber	CS-50	—	AC 250V Suppressed surge voltage: 600 V (peak) or less	XS4 HS8-50		Snap it into the groove of the case. L=0mm
Safety cover	TCS-10, TCS-10T	TC type	—	XS4, 8, 10 frame		
	TCS-20, TCS-20T		—	20 frame		
	TCS-25, TCS-25T		—	25 frame		
	TCS-50, TCS-50T		—	35, 50 frame		
	CVS-10	CV type	—	XS4, 8, 10 frame (non-reversible)		
	CVS-25		—	20, 25 frame		
	CVS-50		—	35, 50 frame		
	CVS-10R		—	10 frame (reversible)		
	FPS-S2	FP type	—	SXS-2		
	FPS-H2		—	SXH-2		
FPS-H4	—		SXH-4			
Mechanical-Interlock unit	RI-50	—	—	10-50 (reversible)		Refer to the instruction manual.

H series						
Item	Model	Configuration	Rating	Applicable model		Mounting
Auxiliary contact block	AX-20	Contact configuration 1a1b	Rated operational current (AC15) 220V 2A 440V 1A Rated thermal current 10A	20, 25, 35, 50 frame	Notes: Cannot be applied to the DC operated contactor (H□□□-G)	 Example of AX-20 Insert protrusions a, b and c into the corresponding holes until the engaging element snaps into the hole.
	AX-65			65C frame		
	AX-80			80C, 100C, 125C, 150C, 200C, 250C, 300C, 400C frame		
Coil surge absorber	CS-8	—	AC 250V Suppressed surge voltage: 600 V (peak) or less	X3, X4, X5, X6, X8, 8C, 10C, 10B, 11, 12, 20, 25, 35, 50, 65C frame	—	Snap it into the groove of the case. L=2-6mm
	CS-80			80C, 100C, 125C frame		
Coil drive unit	CX-20	—	—	20, 25, 35, 50 frame		Install CX-20 in the same way as AX-20. (above)
Safety cover	CV-8E	—	—	8C, 10C frame	—	Example of CV-8E Bend the cover and insert it in the direction of the arrows to snap it into the main unit.  Screw to the cover of the electromagnetic contactor. Dedicated tapping screws are provided.
	CV-11E			11 frame		
	CV-20			20, 25 frame		
	CV-35			35, 50 frame		
	CV-65			65C frame		
	CV-80, CV-80T			80C, 100C, 125C frame		
	CV-150, CV-150T			150C frame		
	CV-200, CV-200T			200C, 250C frame		
	CV-300, CV-300T			300C, 400C frame		
	CV-600, CV-600T			600C, 800C frame		
Thermal overload relay	CV-T20B	—	—	Thermal overload relay	20B frame	Align the notch of the cover with the protrusion of the thermal overload relay and push it.
	CV-T50B			50B frame		
	CV-T80B			80B frame		
Reset release	RR-350	—	Dimension 350mm	Thermal overload relay 20B, 25B, 50B, 80B, 150B frame		Put the reset-release cap onto the current-adjustment knob of the thermal overload relay.
	RR-500		Dimension 500mm			
	RR-600		Dimension 600mm			
Mechanical-Interlock unit	RI-20	—	—	Reversible type of 20, 25, 35, 50 frame		Snap the convex of the interlock unit into the concave of the electromagnetic contactor. Assemble the unit referring to the instruction manual that comes with the unit. 
	RI-65	—	—	Reversible type of 65C frame		
Unit for installing the thermal overload relay solely	ST-12B	—	—	Thermal overload relay 12B frame		

12.2 Coil Surge Absorber



CS-8



H10C with CS-8

<Features>

1. High reliability
2. Easy mounting to contactors and switches.

Generally, in the semiconductor circuits, an external noise may cause an unexpected malfunction. When operating the contactor, the coil generates a sharp surge voltage with the result that the peak voltage may reach higher than 4kV and the frequency higher than 5kHz.

This is radiated as noise to the outside, and it is difficult to prevent such noise even if a protective element is placed in the semiconductor circuit. Therefore, it is necessary to take measures against occurrence of noise from the coil. Connect coil surge absorber to the coil of the contactor in parallel. Then, the noise generated from the coil can be reduced.

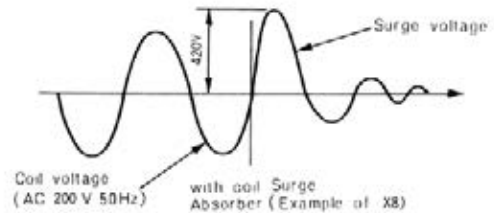
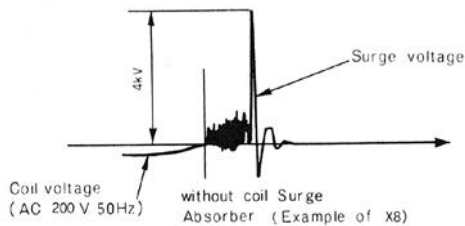

■ Ratings and Specifications

Model	Rated Voltage	Applicable models	Suppressed surge voltage (max.)
CS-50	AC250V	XS4, HS8-HS50	600V Peak
CS-8		X3, X4, X5, X6, X8 H8C, H10C, H10B-R, H11, H12, H20, H25, H35, H50, H65C	
CS-80		H80C, H100C, H125C	

■ Dimensions

CS-8, CS-50, CS-80

(): CS-50 []: CS-80 (CS-8, CS-50:10g, CS-80:20g)

EXAMPLE OF CONNECTION







Connect to the coil terminals of contactor

: Coil Surge Absorber

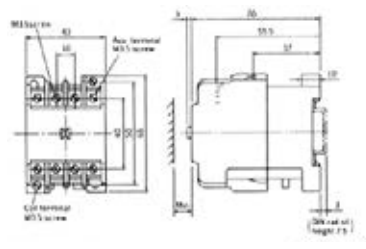
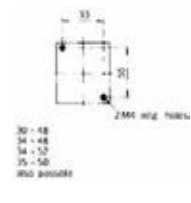
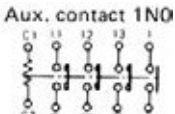
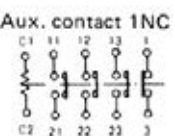
Model	Mounting	Dimensions
CS-50		No change in the size
CS-8 CS-80		ℓ = 2-6mm

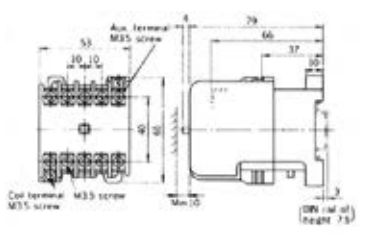
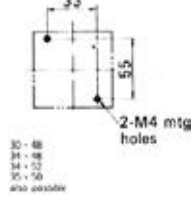
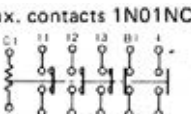
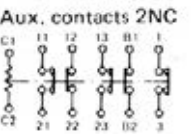
13. OLD PRODUCTS (BACKLOG)

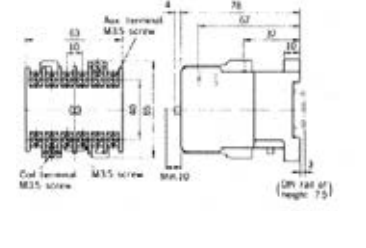
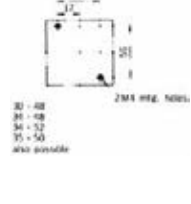
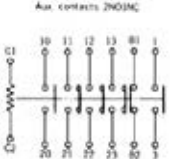
■ Non-Reversible Electromagnetic Contactors without Enclosure

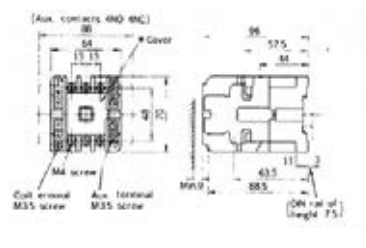
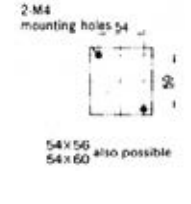
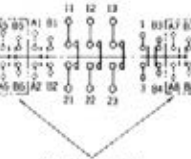
Appearance	Dimensions (mm) (Product mass)	Drilling plan	Contact arrangement	Terminal section dimensions (mm)
 <p>H8C, H10C</p>	 <p>(0.25kg)</p>	 <p>2-M4 mtg. holes</p>	<p>Aux. contact 1NO</p>  <p>Aux. contact 1NC</p> 	<p>Main circuit</p> <p>Terminal screw M3.5</p> <p>Terminal dimensions</p> <p>A 7,8</p> <p>B 5</p> <p>C 4,8</p>
				<p>Operating circuit</p> <p>Terminal screw M3.5</p> <p>Terminal dimensions</p> <p>A 7,8</p> <p>B 5</p> <p>C 4,8</p>
 <p>H11</p>	 <p>(0.32kg)</p>	 <p>2-M4 mtg. holes</p>	<p>Aux. contacts 1NO1NC</p>  <p>Aux. contacts 2NC</p> 	<p>Main circuit</p> <p>Terminal screw M3.5</p> <p>Terminal dimensions</p> <p>A 7,8</p> <p>B 5</p> <p>C 4,8</p>
				<p>Operating circuit</p> <p>Terminal screw M3.5</p> <p>Terminal dimensions</p> <p>A 7,8</p> <p>B 5</p> <p>C 4,8</p>
 <p>H12</p>	 <p>(0.49kg)</p>	 <p>2-M4 mtg. holes</p>	<p>Aux. contacts 2NO1NC</p> 	<p>Main circuit</p> <p>Terminal screw M3.5</p> <p>Terminal dimensions</p> <p>A 7,8</p> <p>B 5</p> <p>C 4,8</p>
				<p>Operating circuit</p> <p>Terminal screw M3.5</p> <p>Terminal dimensions</p> <p>A 7,8</p> <p>B 5</p> <p>C 4,8</p>
 <p>H20</p>	 <p>(0.49kg)</p>	 <p>2-M4 mounting holes 54</p> <p>54x56 also possible</p>	 <p>Aux. contact block</p>	<p>Main circuit</p> <p>Terminal screw M4</p> <p>Terminal dimensions</p> <p>A 9</p> <p>B 4,5</p> <p>C 5,5</p>
				<p>Operating circuit</p> <p>Terminal screw M3.5</p> <p>Terminal dimensions</p> <p>A 7,8</p> <p>B 5,5</p> <p>C 4,8</p>

Model	Dimensions					Minimum mounting space (mm)				
	D	E	F	G	H	D	E	F	G	H
H8C, H10C	10	15	5	10	5	10	15	5	10	5
H11	10	15	5	10	5	10	15	5	10	5
H12	10	15	5	10	5	10	15	5	10	5
H20	9	15	5	10	5	9	15	5	10	5



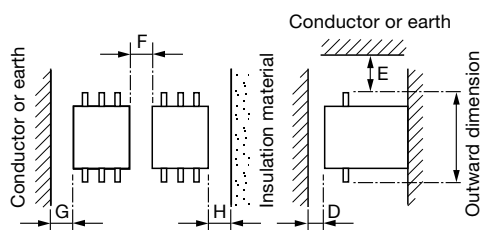

Mounting space

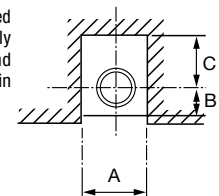

Notes:
Do not operate with the cover removed (Check by removing the cover only when inspecting the contact and always be sure to securely push in the cover after checking).

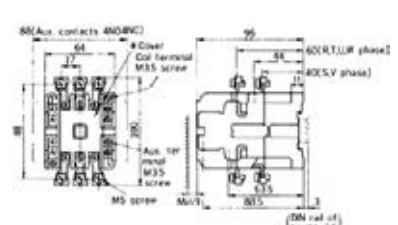
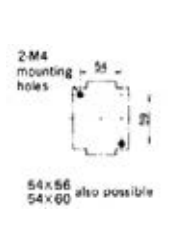
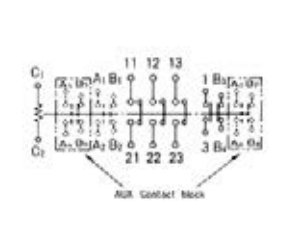
Terminal section dimensions

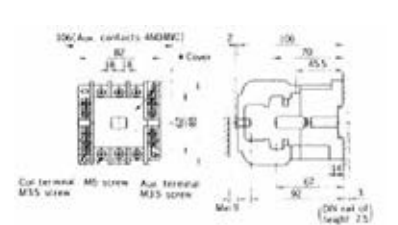
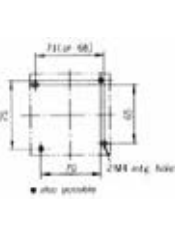
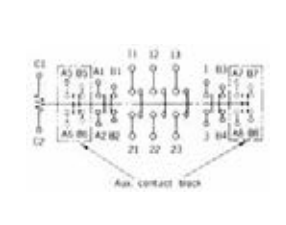

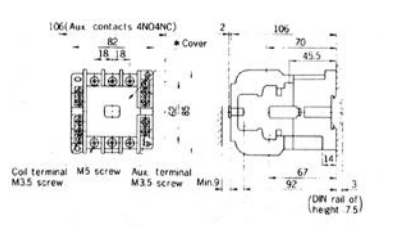
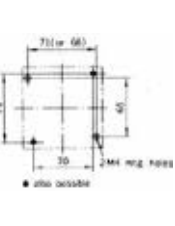
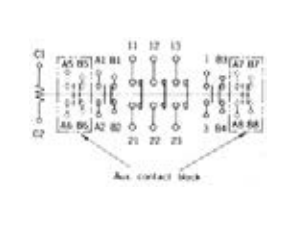
Appearance	Dimensions (mm) (Product mass)	Drilling plan	Contact arrangement	Terminal section dimensions (mm)		
 H25	 (0.53kg)	 2 M4 mounting holes 54x56 also possible	 Aux. Contact Block	Main circuit	Terminal screw	M5
					Terminal dimensions	A
B	6					
Operating circuit	Terminal screw	M3.5				
		Terminal dimensions	A	7.8		
			B	5.5		
C	4.8					
 H35	 (0.77kg)	 2 M4 mtg. holes also possible	 Aux. Contact Block	Main circuit	Terminal screw	M5
					Terminal dimensions	A
B	6					
Operating circuit	Terminal screw	M3.5				
		Terminal dimensions	A	7.8		
			B	5.5		
C	4.8					
 H50	 (0.77kg)	 2 M4 mtg. holes also possible	 Aux. Contact Block	Main circuit	Terminal screw	M5
					Terminal dimensions	A
B	6					
Operating circuit	Terminal screw	M3.5				
		Terminal dimensions	A	7.8		
			B	5.5		
C	4.8					

Model	Dimensions					Minimum mounting space (mm)				
	D	E	F	G	H	D	E	F	G	H
H25	9	15	5	10	5	9	15	5	10	5
H35	9	15	5	10	5	9	15	5	10	5
H50	9	15	5	10	5	9	15	5	10	5



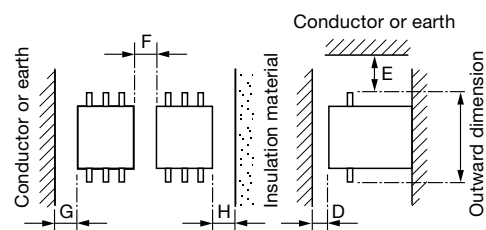



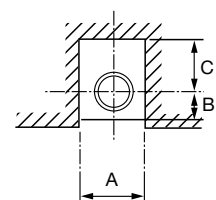

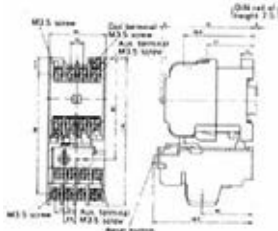

Mounting space

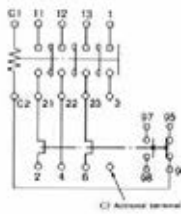

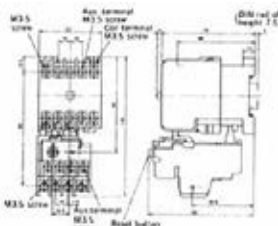
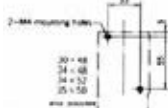
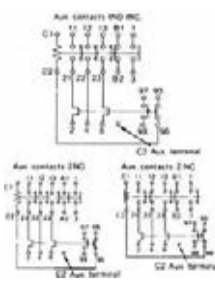
Terminal section dimensions

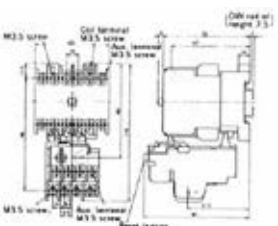

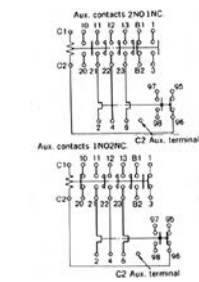
■ Non-Reversible Electromagnetic Switches without Enclosure

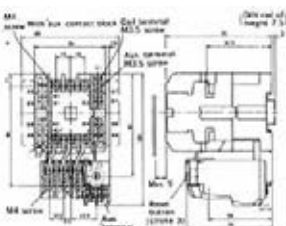
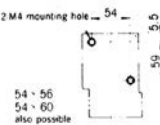
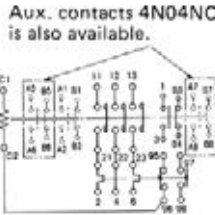
Appearance	Dimensions (mm) (Product mass)	Drilling plan	Contact arrangement	Terminal section dimensions (mm)			
				Terminal screw	Electro-magnetic contactor	Thermal overload relay	
 <p>B) H8-T B) H10C-T</p>	 <p>(0.34kg)</p>			Main circuit	Terminal screw	M3.5	M3.5
					Terminal dimensions	A	7.8
B	5	6					
C	4.8	4.5					
Operating circuit	Terminal screw	M3.5	M3.5				
		Terminal dimensions	A	7.8	7.6		
B	5		4				
C	4.8		4.5				
 <p>B) H11-T</p>	 <p>(0.41kg)</p>			Main circuit	Terminal screw	M3.5	M3.5
					Terminal dimensions	A	7.8
B	5.5	6					
C	4.8	4.5					
Operating circuit	Terminal screw	M3.5	M3.5				
		Terminal dimensions	A	7.8	7.6		
B	5.5		4				
C	4.8		4.5				
 <p>B) H12-T</p>	 <p>(0.65kg)</p>			Main circuit	Terminal screw	M3.5	M3.5
					Terminal dimensions	A	7.8
B	5.5	6					
C	4.8	4.5					
Operating circuit	Terminal screw	M3.5	M3.5				
		Terminal dimensions	A	7.8	7.6		
B	5.5		4				
C	4.8		4.5				
 <p>B) H20-T</p>	 <p>(0.65kg)</p>		 <p>Aux. contacts 4N04NC is also available.</p>	Main circuit	Terminal screw	M4	M4
					Terminal dimensions	A	9
B	4.5	9					
C	5.5	5					
Operating circuit	Terminal screw	M3.5	M3.5				
		Terminal dimensions	A	7.8	7.8		
B	5.5		4				
C	4.8		4.5				

Model	Dimensions					Minimum mounting space (mm)				
	D	E	F	G	H	D	E	F	G	H
B) H8-T B) H10C-T	10	15	5	10	5	10	15	5	10	5
B) H11-T	10	15	5	10	5	10	15	5	10	5
B) H12-T	10	15	5	10	5	10	15	5	10	5
B) H20-T	9	15	5	10	5	9	15	5	10	5

Mounting space

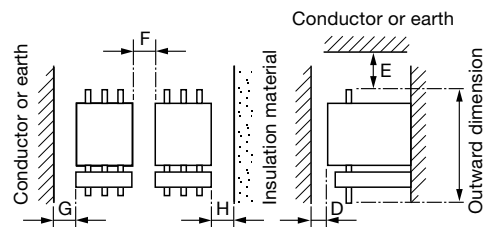

Terminal section dimensions

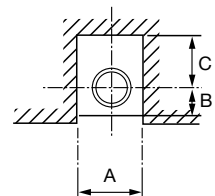

14. MAINTENANCE

• Maintenance of Contacts

Contacts are sometimes subjected to blackening during usage due to oxide and sulfide films. However, use them as they are because they have absolutely no effect on the performance.

• Maintenance of Coil

The allowable voltage regulation as specified in the standard is 85–110% of the rating.

When the voltage is too high, the impulse becomes great in case of closing and not only does it adversely affect each part but the coil becomes overheated and the coil life is shortened.

When the voltage is too low, a humming sound emanates from the magnet due to insufficient closing force of the magnet or a melting phenomenon occurs as the contacting force of the contactor weakens. Therefore, care should be taken that it is only used in the allowable voltage range.

• Tightening of Screws

Since screws will become loosened over a long period of time due to vibrations, etc., be sure to check screws of each section about once a month. When used with the screw loose, the section will overheat and cause troubles.

• Contact Surface of Electromagnet

It will become the cause of beats when dust accumulates or rust forms on the contact surface.

- When dust accumulates on the contact surface:

Clean the surface by wiping with a cloth.

- When rust forms on the contact surface:

Place sandpaper on a flat table and rub the rusted contact surface lightly and evenly on the sandpaper with the rusted surface facing downward.

• Replacement Method of Contact

(Example 1) Case of H20

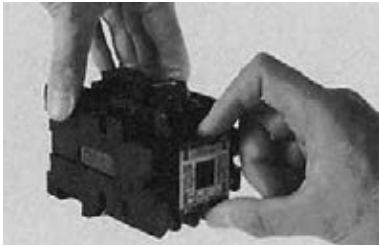

Remove the cover.



Pull out the moving contact with tweezers.

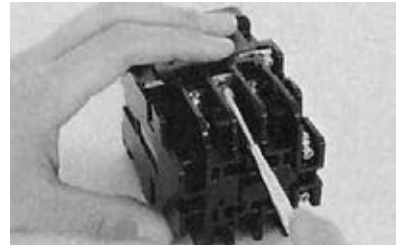

Replace the fixed contact with a screwdriver.

(Example 2) Case of H150C

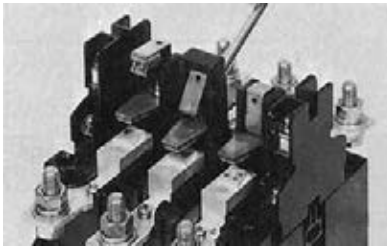

Remove the cover and turn the spring holder.

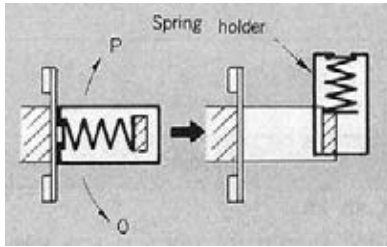

Turn the spring holder with fingers or a screwdriver by pushing to the P or O direction.

Notes: In reassembly, turn the spring holder completely back to its former position.



The moving contact can be removed when turned slightly. Remove the fixed contact with a screwdriver.

• Replacement of Coil

(Example 1) Case of H20

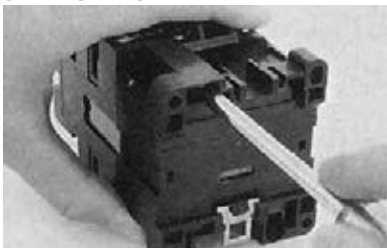

Remove case.



Remove the coil and replace with a new one.

(Example 2) Case of H150C

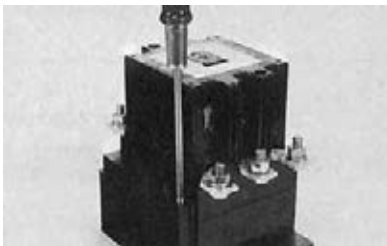

Ⓐ) Loose screws securing Insulating cover to case.

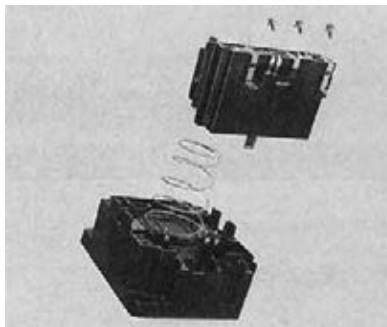

Ⓑ) After removing Insulating cover, loose 3 screws of coil terminals.

Ⓑ) Remove control unit and return spring.

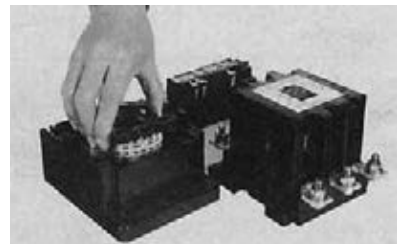

Ⓒ) Replace to prescribed coil.

Ⓒ) Reassemble in order Ⓑ)-Ⓑ)-Ⓐ)

Ⓒ) Control unit must be suit for replaced coil, and must be replaced with coil at the same time.

Ⓒ) Coil terminals for excepting 100/200V coil are Ⓒ)-Ⓑ).

Ⓒ) Secure transparent dustproof covers on both sides.

(Example 3) Case of H300C—H800C

Coil and control unit must be changed at the same time.

(A)



Remove the connecting wires (red, white, yellow) between coil and control unit. Remove the control unit.

(B)



After loosening screws, remove the holding plate. Remove the coil and replace to prescribed coil.

(C)

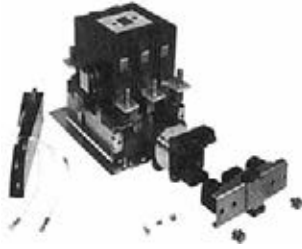

Replace the control unit which must be suit for the coil, at the same time of coil replacement.

Notes:

In case of H600C-R and H800C-R (Reversible type), mount the control unit of the contactor for forward on the left side.

(D)

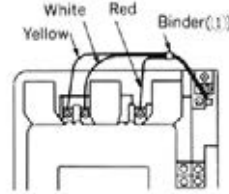

H300C, H400C

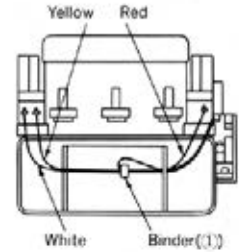

H600C, H800C

Reconnect the wires (red, white, yellow) between coil and control unit.

Notes: Bind the wires with the binder (1) packed with the control unit.

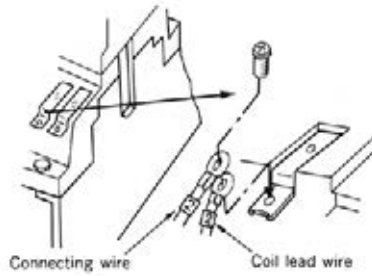

Notes:

In case of H600C, H800C, connecting wires and coil lead wires have the numbers (1, 2, and 3) at the end of wires.

Connect the wires of same number with the terminals.

(E)

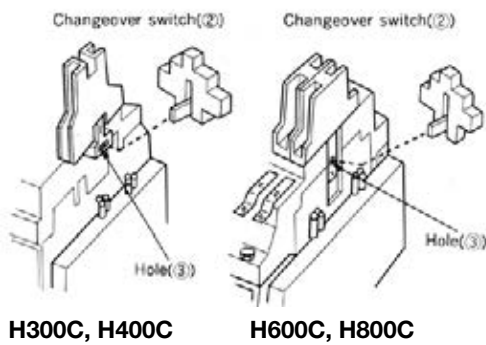

H300C, H400C

H600C, H800C

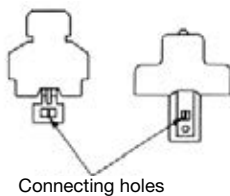

Connecting holes

On mounting the changeover switch (2) on the control unit with screw, projection of movable portion on the changeover switch must be inserted to the hole of crossbar (3) for the auxiliary contact of contactor.

Caution: Insert the projection of the changeover switch to the correct hole of auxiliary contact unit

(F)

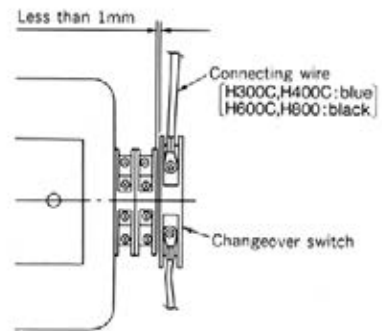

Connect the two blue wires (In case of H600C and H800C, black) with the terminals of changeover switch.

Notes:

After reassembling, adjust position of the control unit to make distance between the top of the changeover switch with the auxiliary contact unit closer than 1mm.

Notes:

- 1) The changeover switches of H600C and H800C differ from H300C and 400C'S ones. (Their shapes are the same but parts in it are not the same.)
- 2) There is the white mark on the case of H600C and H800C's changeover switch, but no mark on H300C and H400C's one.

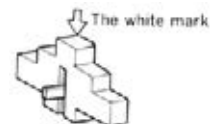

K-TYPE MANUAL SWITCHES



SK2-TB

<Features>

1. Small in Size and Light in Weight

Suitable as small-sized power switches for various kinds of industrial machines.

2. Easy Operation and Accurate Switching

■ Note

These are switches without motor protection device.

■ Specifications





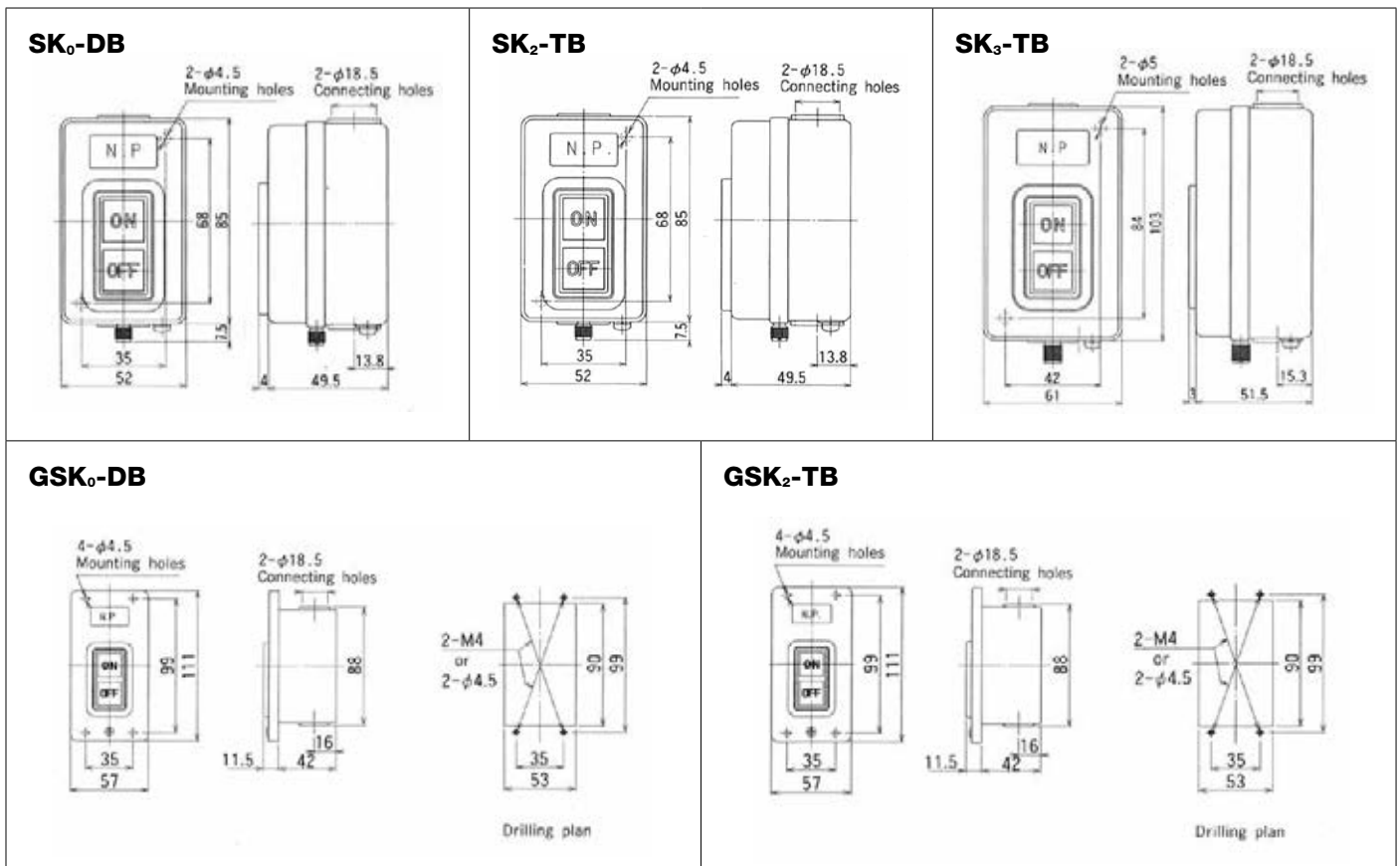







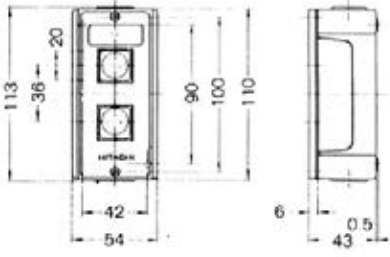

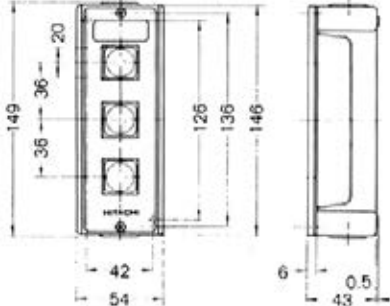

Model	No. of poles	Rated voltage (V)	Applicable motor capacity (HP) (kW)	Resistance load (A)	Mounting method	Mass (kg)
SK ₀ -DB	2	500	(1 \emptyset) 110V 0.4 (1/2) (1 \emptyset) 220V 1.1 (1 1/2)	15	Surface mounting	0.19
GSK ₀ -DB					Flush mounting	0.22
SK ₂ -TB	3	500	220V 2.2 (3) 440V 2.2 (3)	15	Surface mounting	0.19
GSK ₂ -TB					Flush mounting	0.22
SK ₃ -TB	3	500	220V 3.7 (5) 440V 3.7(5)	30	surface mounting	0.27

■ Dimensions

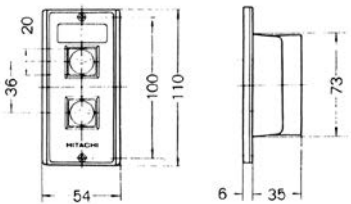
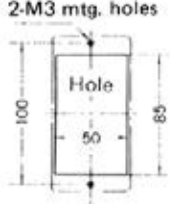

PUSH BUTTONS (FOR OPERATING OF MAGNETIC CONTACTORS AND SWITCHES)

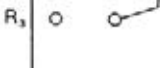
■ Appearance, Dimensions

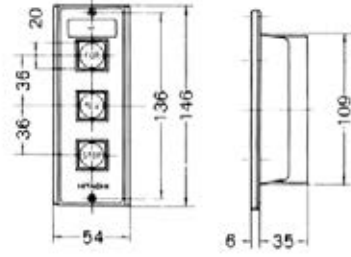
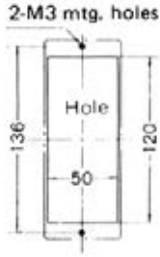
Appearance	Contact arrangement	Dimensions (mm)	Drilling plan
 <p>MB-2B</p>	<p>START</p>  <p>STOP</p> 		<p>2-M4 mtg. holes</p> 
 <p>MB-3B</p>	<p>FOR</p>  <p>REV</p>  <p>STOP</p> 		<p>2-M4 mtg. holes</p> 
 <p>GMB-2B</p>	<p>START</p>  <p>STOP</p> 		<p>2-M3 mtg. holes</p> 
 <p>GMB-3B</p>	<p>FOR</p>  <p>REV</p>  <p>STOP</p> 		<p>2-M3 mtg. holes</p> 

■ Contact Ratings

Rated voltage (V)	Rated current (A)
220	3
440	1.5

■ Durability

Electrical	Mechanical
0.5 million times	5 million times

● **Headquarters**

AKS Building, 3, Kanda Neribei-cho,
Chiyoda-ku, Tokyo, 101-0022, Japan
TEL: <81>(3)4345-6000
FAX: <81>(3)4345-6914

● **Singapore**

Hitachi Asia Ltd.

Power & Industrial Systems Group
24 Jurong Port Road, #03-05 Cwt Distripark,
Office Block, Singapore, 619097
TEL: <65>(6305)7400
FAX: <65>(6305)7401

● **Vietnam**

Hitachi Asia Ltd.(Ho Chi Minh City Office)

7th Floor, The Landmark, 5B Ton Duc Thang
Street District 1, Ho Chi Minh City
TEL: <84>(8)829-9725
FAX: <84>(8)829-9729

(Ha Noi Office)

Sun Red River Bldg, 6th Floor,
23 Phan Chu Trinh Street
Hoan Kiem District Hanoi
TEL: <84>(4)933-3123
FAX: <84>(4)933-3125

● **India**

Hitachi India Trading Pvt. Ltd.

Hindustan Times House (10th Floor)
18-20, Kasturba Gandhi Marg., New Delhi, 110001
TEL: <91>(11)331-5635, 371-2817, -3953, -3958
FAX: <91>(11)331-3742

● **Indonesia**

Hitachi Asia Ltd. (Jakarta Office)

Mid Plaza 1, 10th Floor, J.I. Jend.
Sudirman Kav. 10-11, Jakarta 10220
TEL: <62>(21)574-4313
FAX: <62>(21)574-4312

● **Malaysia**

Hitachi Asia (Malaysia) Sdn. Bhd.

Suite 17.3, Level 17, Menara IMC (Letter Box No.5)
No. 8 Jalan Sultan Ismail, 50250, Kuala Lumpur
TEL: <60>(3)201-8751
FAX: <60>(3)201-8757, -8758

● **Philippines**

Hitachi Asia Ltd. (Philippines Branch)

25th Floor, Pacific Star Building, Cor. Makati & Sen. Gil.
Puyat Ave., Makati, Metro Manila
TEL: <63>(2)819-7528, -7529
FAX: <63>(2)819-7539

● **Thailand**

Hitachi Asia (Thailand) Co., Ltd.

18th Floor, Ramaland Building, 952 Rama IV Road
Bangrak, Bangkok 10500
TEL: <66>(2)632-9292
FAX: <66>(2)632-9299

● **China**

Hitachi East Asia Ltd.

4th Floor, North Tower
World Finance Centre, Harbour City
Canton Road, Tsim Sha Tsui, Kowloon
Hong Kong
TEL: <852>2735-9218
FAX: <852>2735-3192

Hitachi China Ltd. (Beijing Office)

Room 1412, Beijing Fortune Building
5 Dong San Huan BeiLu
Chao Yang District, Beijing 100004
TEL: <86>(10)6590-8851, -8852, -8853, -8854
FAX: <86>(10)6590-8850

Hitachi (Shanghai) Trading Co., Ltd.

18th Floor, Rui Jin Building,
No.205, Maoming Road(S)
Shanghai, 200030
TEL: <86>(21)6472-1002
FAX: <86>(21)6415-8272

Taiwan Hitachi Asia Pacific Co., Ltd.

3rd Floor, Hung Kuo Building No.167
Tun-Hwa North Road, Taipei (105), Taiwan
TEL: <886>(2)2718-3666
FAX: <886>(2)2718-8180

Information in this brochure is subject to change without notice.

 **Hitachi Industrial Equipment Systems Co., Ltd.**

<http://www.hitachi-ies.co.jp/english/index.htm>

For further information, please contact your nearest sales representative.