

High Performance Multifunctional Inverters

FRENIC - MEGA Series



New Standard

FRENIC - MEGA

With the flexibility and functionality to support a wide range of applications on all types of mechanical equipment, the FRENIC-MEGA takes core capability, responsiveness, environmental awareness, and easy maintenance to the next level.

The Industry's Best Just Got Better

Inherits the excellent performance specifications and functionality of the G1 Series while providing a more stylish design.

Unrelenting pursuit of performance and functionality to further enhance adaptability.

It is time to experience the fullness of the MEGA Series world.



High basic performance

Supports vector control, sensorless vector control, dynamic torque vector control, and V/f control.

Various applications

Comes with feature-rich functionality and enhances compatibility with system networks.

FRENIC - MEGA G2 SERIES

Easy maintenance

Enhances work efficiency through simplified wiring and configuration and ensures safety and security through standard features such as preventive and predictive maintenance functions.

Environmentally resistant

Globally compliant lineup compatible with adverse atmospheres and various safety standards.



CONTENTS

Features

High basic performance	04
Various applications	06
Easy maintenance	10
Environmentally resistant	13

Main application examples

Model variations	18
------------------	----

How to read the inverter

modelerter model	18
------------------	----

Standard specifications

[Basic type]	
Three-phase 200V series	20
Three-phase 400V series	21
[EMC filter Built-in type]	
Three-phase 200V series	24
Three-phase 400V series	25

Common specifications

Terminal features	32
Basic wiring diagram	35
External dimensions	
[Basic type & EMC Filter Built-in Type]	36
[Keypad]	40

Keypad functions

Keypad operations	42
Function codes	48
Options	66
Product warranty	76

Features

High basic performance

Supports vector control, sensorless vector control, dynamic torque vector control, and V/f control.

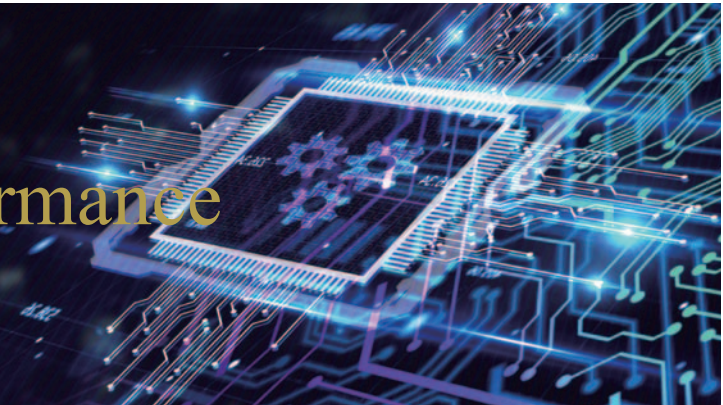

01 Faster operating speeds Expanded range

HIGH BASIC PERFORMANCE

Increases the maximum output frequency of all control systems to 599 Hz and supports applications that require high-speed rotation and minimal speed and torque fluctuations.

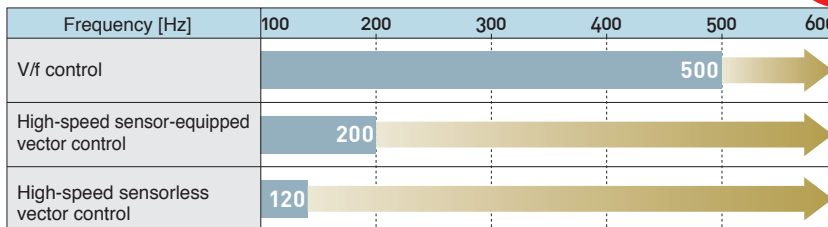

599Hz



Example Machine tools, compressors, automotive testing equipment, etc.

* Due to revised export control regulations (for frequency converters), the inverter will trip when the output frequency exceeds the upper limit of 599 Hz.

02 Enhanced response Improved speed and current

HIGH BASIC PERFORMANCE

Improves speed and current responsiveness and stabilizes product quality by substantially reducing torque ripple and rotation irregularities.

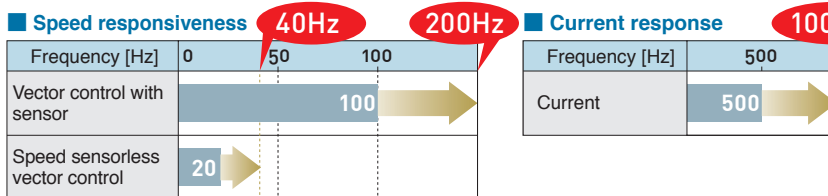

Example Wire drawing machines, metal processing machines, printing machines, etc.

03 Enhanced torque Improves the speed control range

HIGH BASIC PERFORMANCE

Stabilizes torque at low speeds and increases the accuracy of machine operations through its improved speed control range.

Speed control range		Minimum speed	Ratio	Base speed
Induction motor	During sensor-equipped V/f control	Minimum speed	1:20	Base speed
		Constant torque region	1:2	Constant output region
	During sensor-equipped Dynamic torque vector control	Minimum speed	1:200	Base speed
		Constant torque region	1:2	Constant output region
Synchronous motors	During sensorless vector control	Minimum speed	1:200	Base speed
		Constant torque region	1:2	Constant output region
	During sensor-equipped vector control	Minimum speed	1:1500	Base speed
		Constant torque region	1:16	Constant output region
Synchronous motors	During sensorless vector control	Minimum speed	1:10	Base speed
		During sensor-equipped vector control	Minimum speed	1:1500



Example Conveyance machinery, press machines, etc.

04 Advanced dynamic torque vector control

HIGH BASIC PERFORMANCE

Enhances our proprietary dynamic torque vector control with new motor constant tuning (that takes into account the voltage of the main circuit) and newly designed magnetic flux observer.

Low-speed frequency 0.3 Hz → starting torque 200%

Example of torque characteristics (typical unit: 22 kW)

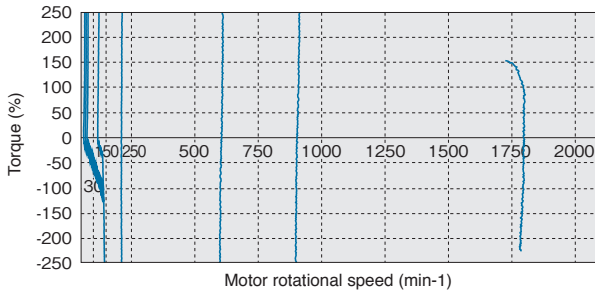

05 Strengthens ability to handle impact loads

HIGH BASIC PERFORMANCE

Achieves its class's highest level of torque responsiveness to sudden load changes. Minimizes fluctuations in motor rotational speed and suppresses vibration via magnetic flux control.

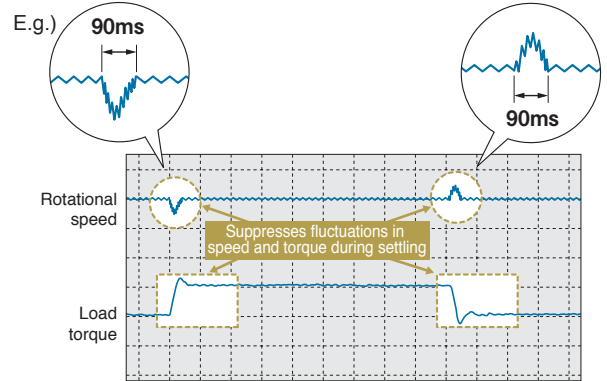

06 Can be used with any motor

HIGH BASIC PERFORMANCE

Comes with new auto-tuning features that enable multi-drive operation using our induction and synchronous motors as well as those of other companies.

* The G2 Series can replace conventional FRENIC-MEGA_GX1S Series products (synchronous motor drive types only).

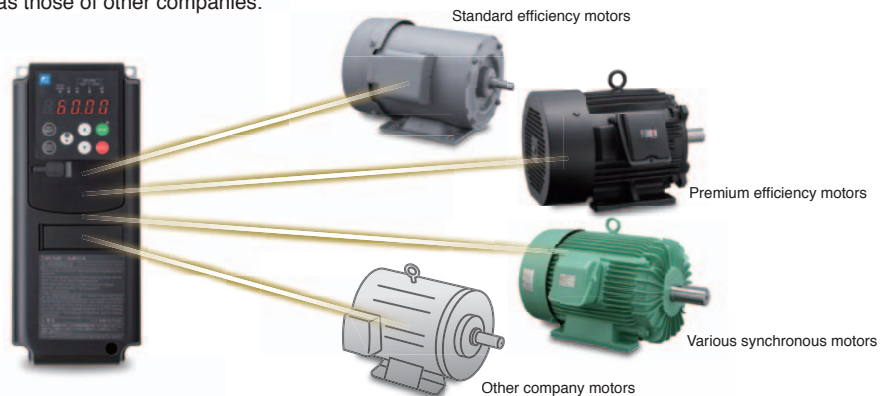

07 Expansion of standard applied motor capacity for the HND specification

HIGH BASIC PERFORMANCE

Expansion

We expanded the rated current and standard applied motor capacity (HND specification) for general loads, making it an easy replacement for our FRENIC-Eco Series (for fans and pumps).

[400 V Series]

Type (FRN□□□G2S/E-4J)	75	90	110	132	160	200	220
New HND specification							
Standard applied motor capacity [kW]	110	132	160	200	220	280	315
Rated current [A]	217	261	290	361	415	547	610

Type (FRN□□□G2S/E-4J)	75	90	110	132	160	200	220
Old HND specification							
Standard applied motor capacity [kW]	90	110	132	160	200	220	280
Rated current [A]	180	216	260	325	377	432	520

08 Expands the capacity of the built-in braking transistor type

HIGH BASIC PERFORMANCE

Enhancement

Comes standard with a larger capacity range and contributes to control panel space and cost savings.

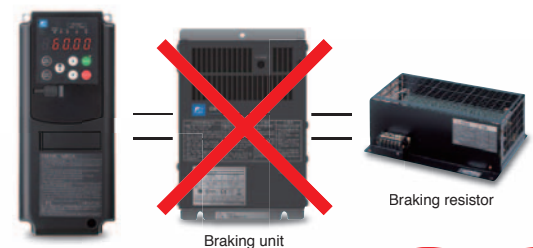

Capacity range

Output [kW]	0.4	0.75	1.5	2.2	3.7	5.5	7.5	11	15	18.5	22	30	37	45
3-phase 200 V series													22	→
3-phase 400 V series													22	→

Features

Various applications

Comes with feature-rich functionality and enhances compatibility with system networks.



01 Positioning

VARIOUS APPLICATIONS

Contributes to shortening machine tact time through high-precision positioning control for pulse string input and feedback output instructions.

Main features	
- Eight positioning data points	- Overtravel detection function
- Pulse train instruction	- Position preset function
- Origin return function	

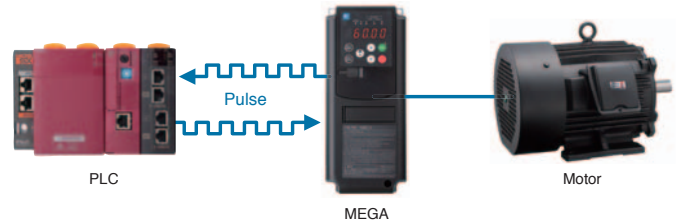

02 Orientation

VARIOUS APPLICATIONS

Capable of rotor positioning, enabling machinery to be held in place via servo locking after stoppage.

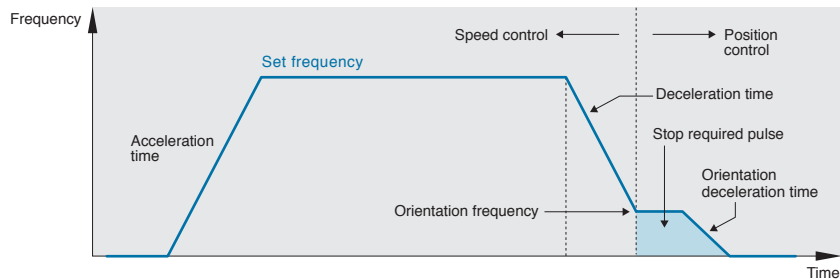

03 PID auto tuning

VARIOUS APPLICATIONS

Simplifies optimization via automatic adjustment of proportional and integral gains, resulting in shorter system start-up times.

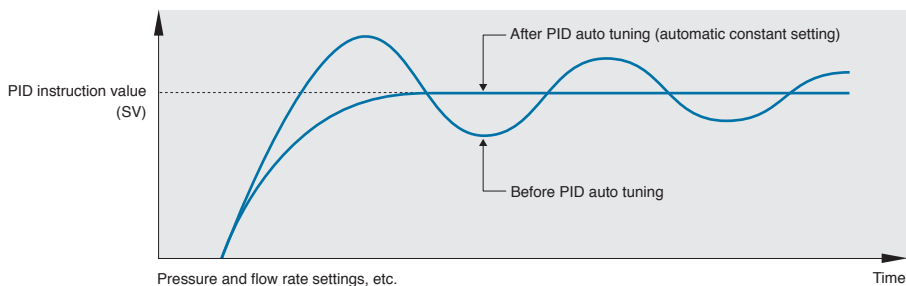

04 Load limiter

VARIOUS APPLICATIONS

Improves system reliability by stopping when excessive torque is detected and by allowing operation only in the direction opposite to that in which the excessive load was detected.

05 Load adaptive control

VARIOUS APPLICATIONS

When the actual load level is lower than the configured load level, the system can be operated at a ratio-multiplied frequency, resulting in significantly better efficiency.

06 Customizable logic functions Enhancement

VARIOUS APPLICATIONS

Customizable inverter functions to meet your own specific needs. Requires no PLC or external control equipment (relays, timers, etc.) circuits, and can be configured simply by setting and combining various parameters inside the inverter.

■ Comes with a wide variety of logic symbols and programming steps

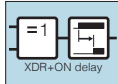
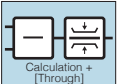
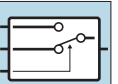
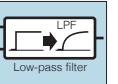
Item	FRENIC-MEGA
Logic symbol type (Logical operations, counters, timers, arithmetic operations, comparators, limiters, selectors, holders, etc.)	<p>Total of 58 digital & analog types</p> <div style="display: flex; justify-content: space-around;"> <div style="text-align: center;">  <p>XDR+ON delay T/C 0 T.P 0</p> <p>Digital operations</p> </div> <div style="text-align: center;">  <p>Calculation + [Through] U.L 0 LL 0</p> <p>Analog operations</p> </div> <div style="text-align: center;">  <p>Selection 3 Step 0</p> <p>Selector</p> </div> <div style="text-align: center;">  <p>Low-pass filter Fl TM. 0 Fix0 0</p> <p>Filter</p> </div> </div>
Number of programming steps	260 steps

* The programming tool software can be downloaded for free from our website.

■ Advantages

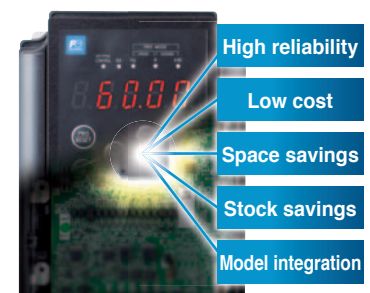

07 PID Control (with 4 PIDs) NEW

VARIOUS APPLICATIONS

Allows switching between two types of process commands and feedback values. PID control function that is easy to adjust using an anti-reset windup function to prevent overshoot of PID control and PID output limiter and integral hold/reset signal. In addition, up to three external actuators can be controlled simultaneously with motor PID control, eliminating the need for a PLC and contributing to system cost reductions.

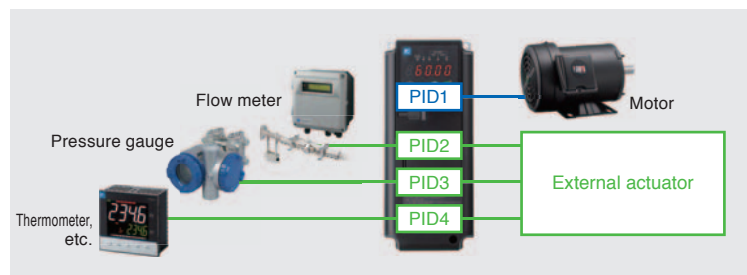

08 Linearize

VARIOUS APPLICATIONS

By controlling the pumping pressure at an appropriate value based on the flow rate and target end pressure, it maintains the discharge pressure and reduces wasteful power consumption, contributing to energy-saving effects.

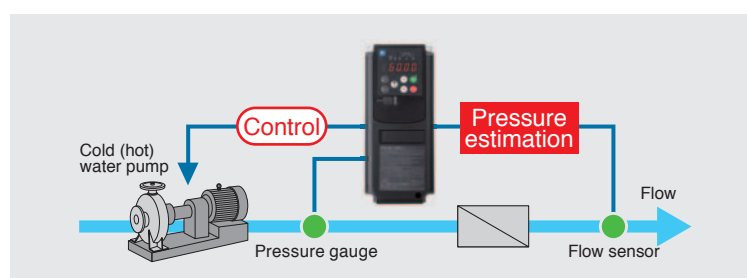

09

Cascade operation NEW

VARIOUS APPLICATIONS

Function to control multiple pumps with one inverter. Control by combining inverter-driven and commercial power-driven operation. The flow and pressure sensor signals are controlled by the PID controller built-in the inverter, and each pump is driven by commercial power or the inverter using switching signals from the inverter.

As a result, when the discharge flow rate is low, only inverter-driven operation is used, and when the discharge flow rate is high, commercial power-driven operation is used in addition to inverter-driven operation to ensure the necessary total discharge flow rate.

Inverter-driven motor fixed system

FIXED

It consists of a combination of a inverter-driven motor (M0), commercial power-driven motors (M1 to M8), and an auxiliary motor (MA). The inverter-driven motor is fixed to motor M0. When the desired discharge flow rate is not achieved with only motor M0, control is performed by sequentially adding commercial power-driven motors.

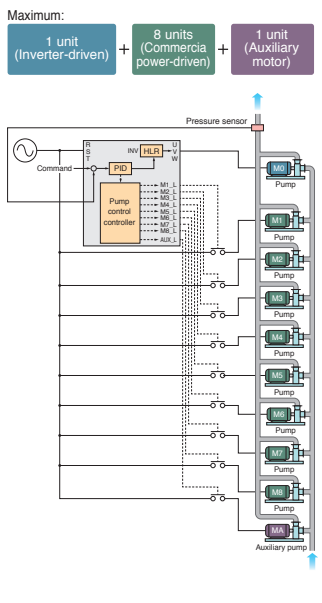

*When using the optional relay output card (OPC-RV2)

Inverter-driven motor circulation system

FLOATING

It consists of a combination of motors (M1 to M4) that can switch between inverter-driven and commercial power-driven operation, and an auxiliary motor (MA) that is driven by commercial power. Variable speed control using inverter-driven operation at startup. If the desired discharge flow rate is not achieved with only the first motor, the operation of FLOATING-1 or FLOATING-2 can be selected.

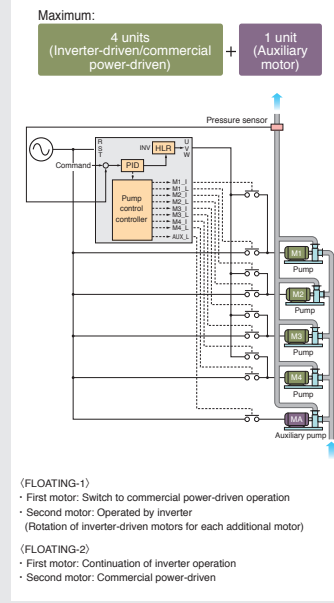

Communication link method: Rotary operation

Each inverter is connected via a communication link, eliminating the need for a controller when building systems. In addition, the communication link reduces wiring without requiring any additional options.

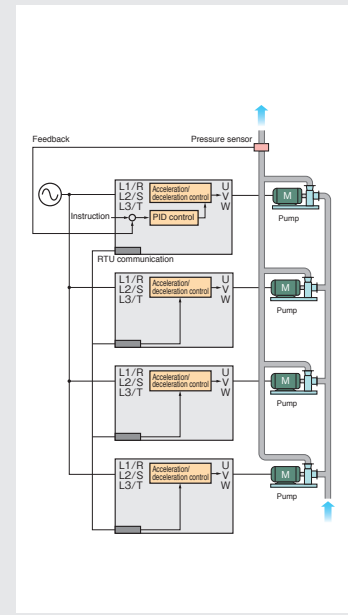

10

Constant control of temperature and pressure differences

VARIOUS APPLICATIONS

Reduces wasteful power consumption by lowering fan output when it is difficult to lower internal temperatures due to environmental factors such as the outdoor air temperature being higher than that of the cooling water. Temperature can be detected directly with the resistance temperature sensor by using an OPC-PT option card.

Note) The resistance temperature sensor needs to be purchased separately.

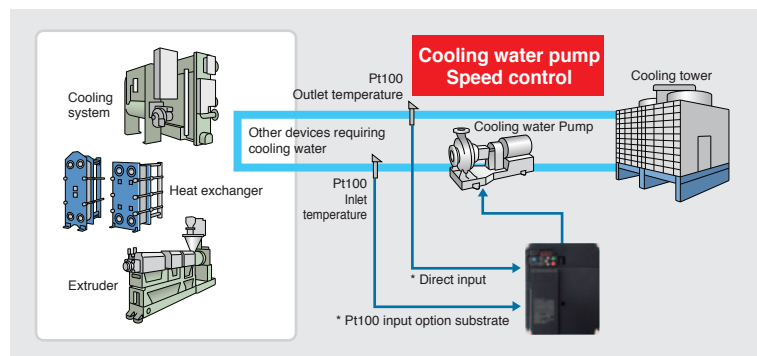

11

VARIOUS APPLICATIONS

Prevention of filter clogging

NEW

It detects filter clogging due to dust, etc., based on output current and pressure sensor values, and removes the dust through reverse rotation. In addition, an alarm is used to indicate that maintenance is required.

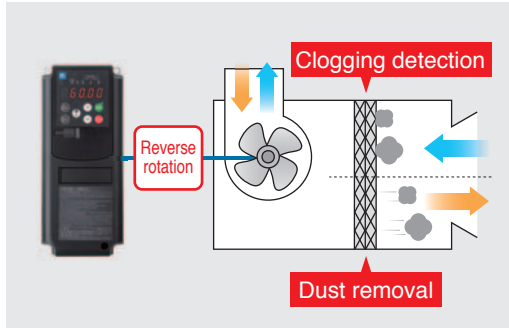

12

VARIOUS APPLICATIONS

Fire Mode

In the event of a fire or other emergency, the inverter's protective function (output shutoff) is partially ignored and operation is continued. This prevents the building from being filled with smoke and secures an evacuation passage.

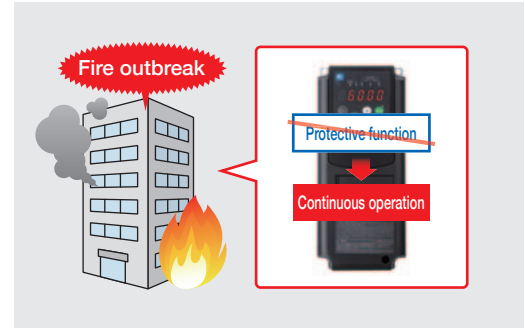

13

VARIOUS APPLICATIONS

Supports a variety of networks Option cards

Insert the option card into the connector inside the main unit.
Up to three cards can be inserted.

Optional communication card types

<ul style="list-style-type: none"> 1 DeviceNet 2 CC-Link 3 T-Link 	<ul style="list-style-type: none"> 4 PROFIBUS-DP 5 CANopen 6 SX bus 	<ul style="list-style-type: none"> 7 Ethernet (EtherNet/IP, PROFINET RT) <li style="background-color: red; color: white; padding: 2px; display: inline-block;">Coming soon (Modbus-TCP, BACnet/IP, and EtherCAT)
--	--	--

Note) There are some limitations to how option cards can be combined. Please contact us for details.

* For other types of option cards, please refer to page 70.

14

VARIOUS APPLICATIONS

Enhanced network functions Compatible with RS-485 communication (terminal block)

Comes standard with an RS-485 terminal in addition to a port (RJ-45 connector) that is shared with the keypad. Simplifies multi-drop connections via terminal connection.

Supports RS-485 terminal multi-drop connection

Compatible protocols

- Modbus-RTU
- Metasys N2 (New)
- BACnet MS/TP (Coming soon)
- Our company inverter protocol

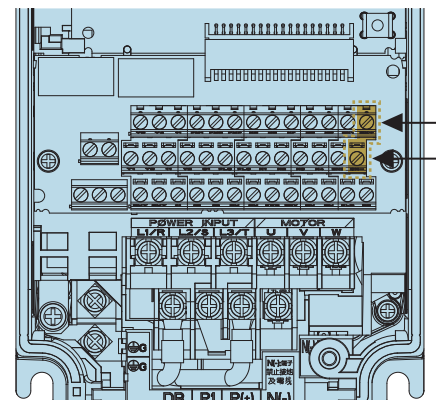

Features

Easy maintenance

Enhances work efficiency through simplified wiring and configuration and ensures safety and security through standard features such as preventive and predictive maintenance functions.



01 Same mounting dimensions

MAINTAINABILITY The appearance and mounting dimensions of the inverter are fully compatible. The 3D position and size of the main circuit screw terminals are also the same.

* Can be installed as a replacement for conventional FRENIC-MEGA_G1 series products.



02 Simple wiring

MAINTAINABILITY The control terminal block uses an industry-standard rod-shaped block (44-pole, ⊖ screw) and improves workability of wiring.

Supports replacement or mounting of conventional FRENIC-MEGA_G1 Series' round terminal blocks (35-pole ⊕ screw).

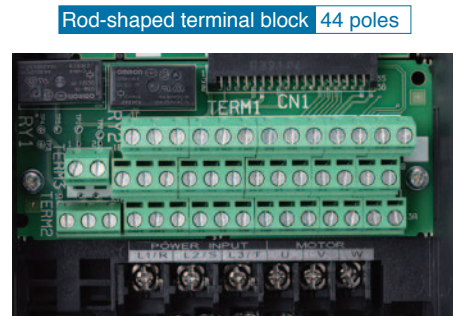

03 Easy parameter migration

MAINTAINABILITY Compatibility mode allows parameters read from the previous model to be written directly to the G2 Series.



* The previous models include FRENIC-MEGA_G1 and FRENIC-MEGA_GX1 FRENIC-Eco series products.
 * Data can be read from a touch panel (TP-E1U/TP-G1-J1) or PC loader from a conventional FRENIC-MEGA_G1 Series product and copied to the G2 Series.
 Please be assured that the function codes newly added in the G2 Series will not be changed.

04 Designed with new operation keypad

MAINTAINABILITY

Comes standard with a 7-segment 5-digit LED display whose large screen is very intuitive and enhances maintainability via improved key button operability and cursor digit control.

Standard

G2
TP-E2



G1
TP-E1U



Multi-function Option

G2
TP-A2SW



G1
TP-G1-J1



Additional features

Character display

- 7-segment, 5-digit LED display.

"M/Shift" key

- The cursor can be moved to any position.
- Can assign the same signals as the digital input terminal (X terminal).
- Can fix the assigned signal to ON by pressing and holding the key.

"M" LED display

- Can use LEDs to monitor the digital output signals of inverters.
- Y-terminal signals can be assigned to enable checking without using a conventional loader or keypad.

Additional features

Character display

- Equipped with a highly visible LCD.
- Supports a total of 20 languages, including Japanese hiragana, katakana and kanji.

0: Japanese	1: English	2: German	3: French	4: Spanish
5: Italian	6: Chinese	7: Korean*	8: Russian	9: Greek
10: Turkish	11: Polish	12: Czech	13: Swedish	14: Portuguese
15: Dutch	16: Malay	17: Vietnamese	18: Thai	19: Indonesian

* Compatible with the software version, main product ROM0500 or later and the multifunctional keypad ROM5020 or later.

USB port

- Mounts to both standard keypad and multifunctional keypad.
- Can be directly connected to a PC with a commercially available USB cable (mini B).

Clock function

- Time data can be added to the alarm history.

* Battery (CR2032 type) not included.

SD card slot

- Can store traceback data on micro SD card.

* SD card not included.

Water resistant

- The front surface and sides are IP55 protected. * The back side is IP20 protected.

Built-in Bluetooth

- Parameter changes and maintenance can be performed remotely using a mobile device.

* Radio law certified countries: Japan, Europe, North America, China, Thailand

05 Enhancement of alarm history/traceback function

MAINTAINABILITY

- Capable of displaying and saving data for the past 4 alarms, such as output voltage and output frequency at times of alarms.
 - * When using the multifunctional keypad, you can also obtain data on the time of occurrence. However, batteries are required.
- When an alarm occurs, previous waveform data can be acquired and saved.

Number of saved items

	Number of alarms
Standard keypad (TP-E2)	1
Multifunctional keypad (TP-A2SW)	100 *SD card

*The above is the number of saved tracebacks.

Features
 Main application examples
 Model variations
 Type number nomenclature
 Standard specifications
 Common specifications
 Terminal specifications
 Basic wiring diagram
 External dimensions
 Keypad
 Function codes
 Options
 Product warranty

06 Enhanced PC loader functions

MAINTAINABILITY

- The PC loader can be used by directly connecting the keypad to a PC using a commercially available USB cable (mini B).
- It makes it easy to store or check various types of information at the office, or send information and check abnormalities at

PC loader
Can operate with inverters via online connection

Remote keypad
Capable of writing information to the keypad memory

Usage examples

- At offices
- At production sites

07 Life expectancy diagnosis and maintenance functions Enhancement

MAINTAINABILITY

The keypad and PC loader make it easy to check the status of equipment and detect problems before they occur, helping to reduce production equipment maintenance time and downtime.

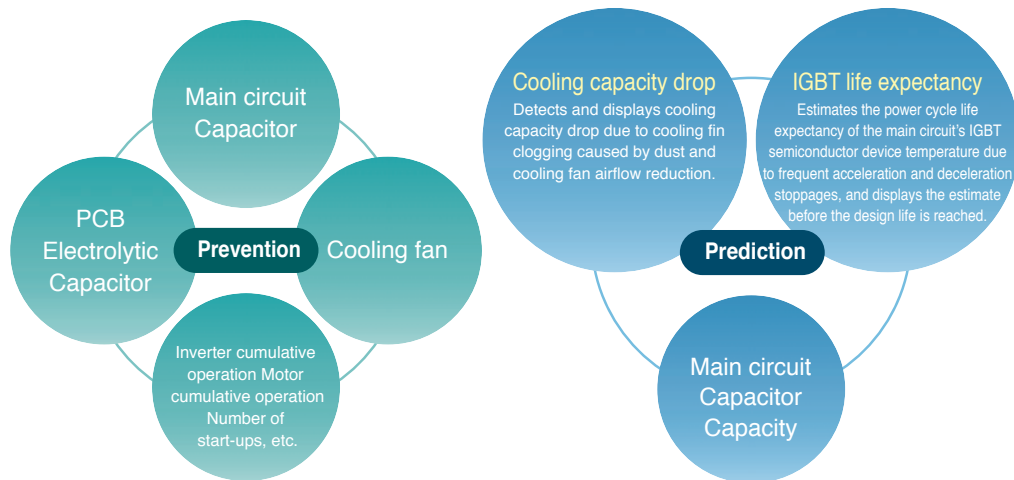

08 Long life expectancy (main components)

MAINTAINABILITY

Many of the serviceable parts inside the inverter have been designed to meet

Design life

10 years

Main circuit capacitor



PCB Electrolytic capacitor

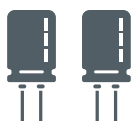

Cooling fan



* The above values refer to the design life (calculated values) and are not guaranteed values.

Life expectancy conditions Ambient temperature 40°C, load factor 100% (HHD specification), 80% (HND specification)

Features

Environmentally resistant

Globally compliant lineup compatible with adverse atmospheres and various safety standards.

01 Improves environmental resistance Enhancement

ENVIRONMENTAL RESISTANCE

- (1) Uses copper bars with Ni and Sn plating
- (2) Ambient operating temperature up to +55°C
* Derating is required when used at 50°C or higher.
- (3) Further strengthens PCB coating
(JIS C 60721-3-3/IEC 60721-3-3 Class 3C2)
* Products also available with enhanced salt-resistance and made-to-order specifications.
- (4) IP55 protection for the inverter's main cooling unit contributes to enhanced cooling outside the panel, lower costs, and downsizing.

Note) If you are using or considering using the product under the following conditions, please contact our sales department.
a. Environments containing sulfurized gas (e.g., some applications in the tire manufacturing, paper manufacturing, sewage treatment, textile industries, etc.)
b. Environments containing conductive dust and foreign objects (e.g., metal processing machines, extruders, printing machines, waste disposal machinery, etc.)
c. When using the product in non-standard environments

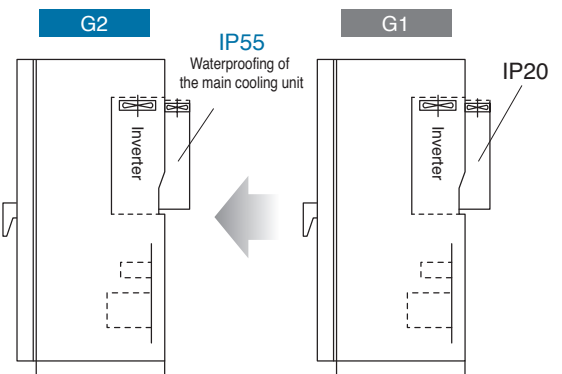

* Supports only 30 kW to 630 kW

02 Includes safety functions

ENVIRONMENTAL RESISTANCE

- Compliant with European safety standards.
(EN ISO 13849-1:2015, Cat3/PL-e IEC/EN61800-5-2:2016 SIL3 (STO))
*The zero-phase reactor built-in type does not comply with the EC Directive (CE marking).
- The inverter comes with a function that enables it to adapt to machine safety. This facilitates the design of main circuit switching devices for ensuring safe stoppages.

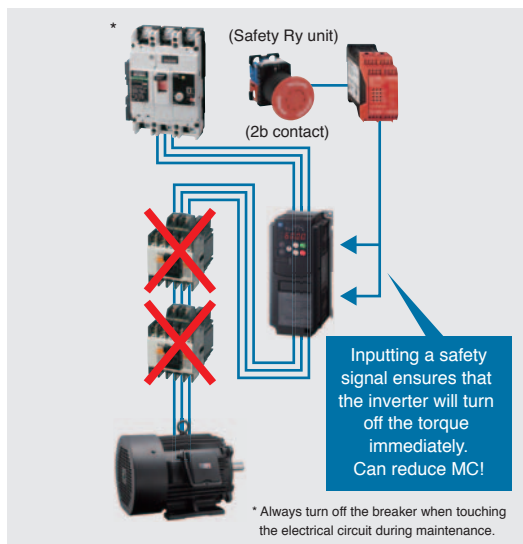

03 Compliant with the revised European RoHS Directive

ENVIRONMENTAL RESISTANCE

■ Ten environmental impact substances



- Lead, mercury, cadmium, and hexavalent chromium
- Polybrominated biphenyl (PBB)
- Polybrominated diphenyl ether (PBDE)
- Di-2-ethylhexyl phthalate (DEHP)
- Butyl benzyl phthalate (BBP)
- Di-n-butyl phthalate (DBP)
- Diisobutyl phthalate (DIBP)

04 Globally compliant

ENVIRONMENTAL RESISTANCE

Compliant with overseas safety standards.

European regions	United States/Canada
EC directive (CE marking) 	UL standard/cUL standard

*The zero-phase reactor built-in type does not comply with the EC Directive (CE marking).

Expansion of Mega Series app

Fans and pumps

Others Blowers, turbo chillers, etc.

» PID control Auto tuning function

Ensures smooth equipment startup and optimal operation adjustment through automatic PID parameter adjustment.

» Automatic energy-saving operation mode

Minimizes inverter and motor loss through automatic operation, helping to achieve equipment energy savings.

» Multi drive New auto tuning function

Enables multi-drive operation with a single inverter through induction and synchronous motor tuning.

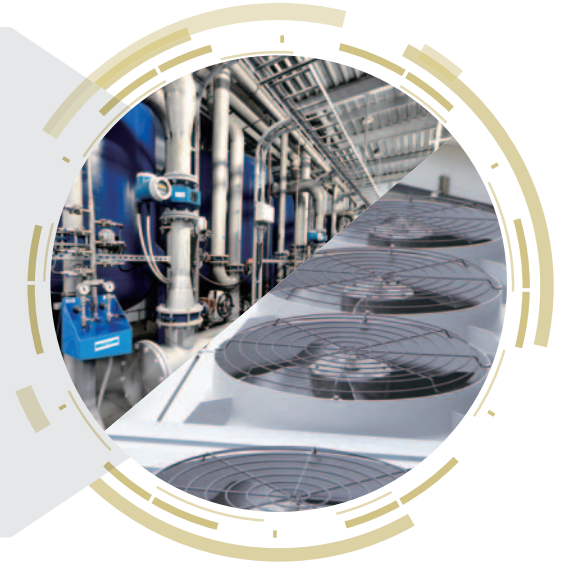

Compressors

Others Machine tools, gear pumps, etc.

» Sensorless vector control Synchronous motors

Capable of driving synchronous motors up to 599 Hz, helping to achieve equipment downsizing and energy savings.



Machine tools

Others Compressors, automobile testing instruments, etc.

» Position control Orientation functions

Enables operation and rotator stopping angle specification using tool changer positioning, allowing stopped machinery to be held in place via servo locking.

» Speed responsiveness Vector control

Reduces the effects of rotation irregularities and interference on machines through improved responsiveness (with sensor: 200 Hz; without sensor: 40 Hz).

» High-speed operation

Expands the output frequency range to 599 Hz for all control methods and shortens machining times through high-speed rotation.



Applications

Supports a wide variety of applications and is useful in various situations.



Press machines Others Forging press machines, hoisting and transporting, etc.

» High-speed responsiveness Speed and current response Vector control

Stabilizes quality by ensuring a constant rotational speed during load fluctuations through improved speed and current responsiveness.

» Regeneration avoidance function

Stabilizes operations by suppressing load fluctuation overvoltage alarms even in regenerative mode.

» Built-in braking transistor

Saves space and reduces cost of electric panels by expanding the capacity range (200 V series: 0.4 to 55 kW, 400 V series: 0.4 to 75 kW).

Winding machines Others Printing machines, wrapping machines, etc.

» High-speed responsiveness Speed and current response Vector control

Stabilizes quality by ensuring a constant rotational speed during load fluctuations through improved speed and current responsiveness.

» Stability at low speeds

Can control product quality variations even when the motor is running at low speed.

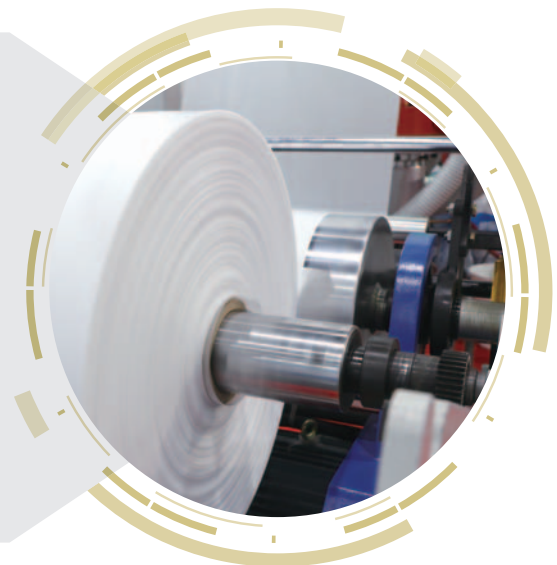

Hoists Others Cranes and multistory warehouses, etc.

» Load adaptive control Load adaptive control

When the actual load level is lower than the configured load level, the system can be operated at a ratio-multiplied speed (in terms of the configured frequency), resulting in significantly better efficiency.

» Load limiter Load limiter

Maintains safety and rescuability of suspended loads by stopping when excessive torque is detected and by allowing operation only in the direction opposite to that in which the excessive load was detected.

» Vector control Torque biasing function

Automatically incorporates the load portion into torque instructions to enable smooth start-up compensation during lifting and lowering.



Features

Main application examples

Model variations

Type number nomenclature

Standard specifications

Common specifications

Terminal specifications

Basic wiring diagram

External dimensions

Keypad

Function codes

Options

Product warranty

Main application examples

Stacker cranes

Others Elevators, escalators, etc.

» Position control function

Enables high-precision positioning control and tact time reduction through use of pulse train instructions and operations, origin return, and position preset overtravel detection.

» Brake release signals

Outputs braking signals based on inverter operating conditions to prevent cargo bed rollback and overrunning.

» Motor constant switching

Enables multi-motor switchover operation for driving, lifting, and forking applications, and reduces costs by decreasing the number of inverters in use.



Multistory parking lots

Others Cranes, hoists, etc.

» Built-in braking transistor

Saves space and reduces cost of electric panels by expanding the capacity range (200 V series: 0.4 to 55 kW, 400 V series: 0.4 to 75 kW).

» Dynamic torque vector control

Enables smooth startup by outputting powerful torque even at low speeds.

» Brake release signals

Outputs braking signals based on inverter operating conditions to prevent vehicle rollback and overrunning.



Automotive testing equipment

Others Machine tools, press machines, etc.

» Torque control **Sensor-equipped vector control**

Supports configuration of test equipment for simulating loads using torque control.

» High-speed responsiveness **Speed and current response** **Vector control**

Enables quantification of testing by ensuring a constant rotational speed during load fluctuations through improved speed and current responsiveness.

» Speed control range **Sensor-equipped vector control**

Enables high-speed motor driving rotation testing through expansion of the constant output range (1:16).

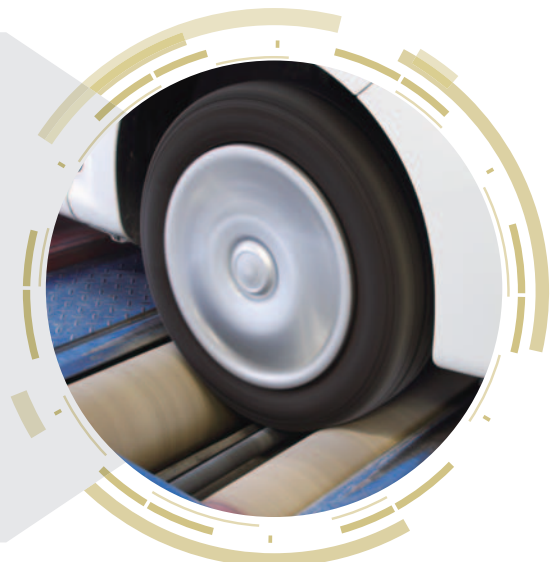



Crushing machines

» Dynamic torque vector control

Enables powerful operation even during sudden load changes and low-speed rotation.

» Life expectancy forecasting

Monitors inverter current and temperature rise to predict and detect inverter tripping and failure. Prevents equipment stoppages and reduces downtime.

» Customizable logic functions

Enables creation of customized programs (such as a program for recovering from stoppages due to jamming) by combining a wide variety of digital and analog operation blocks.

Plant related

1 Rolling mills

» High-speed responsiveness Speed and current response Vector control

Enables high-precision roller operation by ensuring a constant rotational speed during load fluctuations through improved speed and current responsiveness.

» Load inertia estimation

Estimates the theoretical acceleration and deceleration time based on the load inertia, enabling users to make optimal settings.

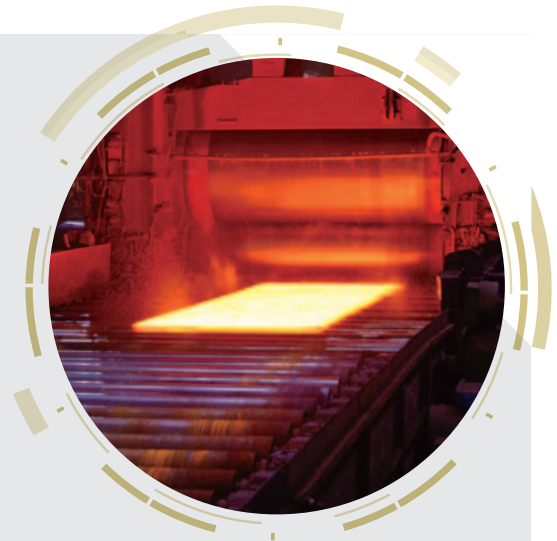

2 Kilns

» Multi-pole motor operation

Can operate motors with up to 128 poles and supports rated frequencies as low as 5 Hz.

» Life expectancy forecasting

Monitors inverter current and temperature rise to predict and detect inverter tripping and failure. Prevents device and equipment stoppages and reduces downtime.

Model Variations

Model list

HHD spec (High carrier frequency Heavy Duty) : 200%-3s, 150%-1min
 HND spec (High carrier frequency Normal Duty) : 120%-1min

Standard applied motor [kW (HP)]	Basic type					
	3-phase 400 V series				3-phase 200 V series	
	ND spec	HD spec	HND spec	HHD spec	HND spec	HHD spec
0.4(1/2)				FRN0002G2S-4G		FRN0003G2S-2G
0.75(1)				FRN0003G2S-4G		FRN0005G2S-2G
1.5(2)				FRN0004G2S-4G		FRN0008G2S-2G
2.2(3)				FRN0006G2S-4G		FRN0011G2S-2G
3.7(5)				FRN0009G2S-4G		FRN0018G2S-2G
5.5(7.5)				FRN0018G2S-4G		FRN0032G2S-2G
7.5(10)			FRN0018G2S-4G	FRN0023G2S-4G	FRN0032G2S-2G	FRN0046G2S-2G
11(15)			FRN0023G2S-4G	FRN0035G2S-4G	FRN0046G2S-2G	FRN0059G2S-2G
15(20)			FRN0035G2S-4G	FRN0041G2S-4G	FRN0059G2S-2G	FRN0075G2S-2G
18.5(25)			FRN0041G2S-4G	FRN0045G2S-4G	FRN0075G2S-2G	FRN0088G2S-2G
22(30)			FRN0045G2S-4G	FRN0060G2S-4G	FRN0088G2S-2G	FRN0115G2S-2G
30(40)			FRN0060G2S-4G	FRN0085G2S-4G	FRN0115G2S-2G	FRN0146G2S-2G
37(50)		FRN0085G2S-4G	FRN0085G2S-4G	FRN0105G2S-4G	FRN0146G2S-2G	FRN0180G2S-2G
45(60)	FRN0085G2S-4G	FRN0105G2S-4G	FRN0105G2S-4G	FRN0139G2S-4G	FRN0180G2S-2G	FRN0215G2S-2G
55(75)	FRN0105G2S-4G	FRN0139G2S-4G	FRN0139G2S-4G	FRN0179G2S-4G	FRN0215G2S-2G	FRN0288G2S-2G
75(100)	FRN0139G2S-4G	FRN0179G2S-4G	FRN0179G2S-4G	FRN0217G2S-4G	FRN0288G2S-2G	FRN0346G2S-2G
90(125)	FRN0179G2S-4G	FRN0217G2S-4G	FRN0179G2S-4G	FRN0261G2S-4G	FRN0346G2S-2G	FRN0432G2S-2G
110(150)	FRN0217G2S-4G	FRN0261G2S-4G	FRN0217G2S-4G	FRN0290G2S-4G	FRN0432G2S-2G	
132(200)	FRN0261G2S-4G	FRN0290G2S-4G	FRN0261G2S-4G	FRN0376G2S-4G		
160(250)	FRN0290G2S-4G	FRN0376G2S-4G	FRN0290G2S-4G	FRN0431G2S-4G		
200(300)	FRN0376G2S-4G	FRN0431G2S-4G	FRN0376G2S-4G	FRN0547G2S-4G		
220(350)	FRN0431G2S-4G	FRN0547G2S-4G	FRN0431G2S-4G	FRN0610G2S-4G		
250(400)		FRN0610G2S-4G				
280(400)	FRN0547G2S-4G		FRN0547G2S-4G	FRN0739G2S-4G		
315(450)	FRN0610G2S-4G	FRN0739G2S-4G	FRN0610G2S-4G	FRN0840G2S-4G		
355(500)		FRN0840G2S-4G	FRN0739G2S-4G	FRN1039G2S-4G		
400(600)	FRN0739G2S-4G	FRN1039G2S-4G	FRN0840G2S-4G	FRN1169G2S-4G		
450(700)	FRN0840G2S-4G	FRN1169G2S-4G				
500(800)			FRN1039G2S-4G	FRN1385G2S-4G		
560(900)	FRN1039G2S-4G	FRN1385G2S-4G	FRN1169G2S-4G			
630(900)	FRN1169G2S-4G		FRN1385G2S-4G	FRN1480G2S-4G		
710(1200)	FRN1385G2S-4G	FRN1480G2S-4G	FRN1480G2S-4G			
800(1300)	FRN1480G2S-4G					

Standard applied motor [kW (HP)]	EMC filter built-in type			
	3-phase 400 V series			
	ND spec	HD spec	HND spec	HHD spec
0.4(1/2)				FRN0002G2E-4G
0.75(1)				FRN0003G2E-4G
1.5(2)				FRN0004G2E-4G
2.2(3)				FRN0006G2E-4G
3.7(5)				FRN0009G2E-4G
5.5(7.5)				FRN0018G2E-4G
7.5(10)			FRN0018G2E-4G	FRN0023G2E-4G
11(15)			FRN0023G2E-4G	FRN0035G2E-4G
15(20)			FRN0035G2E-4G	FRN0041G2E-4G
18.5(25)			FRN0041G2E-4G	FRN0045G2E-4G
22(30)			FRN0045G2E-4G	FRN0060G2E-4G
30(40)			FRN0060G2E-4G	FRN0085G2E-4G
37(50)		FRN0085G2E-4G	FRN0085G2E-4G	FRN0105G2E-4G
45(60)	FRN0085G2E-4G	FRN0105G2E-4G	FRN0105G2E-4G	FRN0139G2E-4G
55(75)	FRN0105G2E-4G	FRN0139G2E-4G	FRN0139G2E-4G	FRN0179G2E-4G
75(100)	FRN0139G2E-4G	FRN0179G2E-4G	FRN0179G2E-4G	FRN0217G2E-4G
90(125)	FRN0179G2E-4G	FRN0217G2E-4G	FRN0179G2E-4G	FRN0261G2E-4G
110(150)	FRN0217G2E-4G	FRN0261G2E-4G	FRN0217G2E-4G	FRN0290G2E-4G
132(200)	FRN0261G2E-4G	FRN0290G2E-4G	FRN0261G2E-4G	FRN0376G2E-4G
160(250)	FRN0290G2E-4G	FRN0376G2E-4G	FRN0290G2E-4G	FRN0431G2E-4G
200(300)	FRN0376G2E-4G	FRN0431G2E-4G	FRN0376G2E-4G	FRN0547G2E-4G
220(350)	FRN0431G2E-4G	FRN0547G2E-4G	FRN0431G2E-4G	FRN0610G2E-4G
250(400)		FRN0610G2E-4G		
280(400)	FRN0547G2E-4G		FRN0547G2E-4G	FRN0739G2E-4G
315(450)	FRN0610G2E-4G	FRN0739G2E-4G	FRN0610G2E-4G	FRN0840G2E-4G
355(500)		FRN0840G2E-4G	FRN0739G2E-4G	FRN1039G2E-4G
400(600)	FRN0739G2E-4G	FRN1039G2E-4G	FRN0840G2E-4G	FRN1169G2E-4G
450(700)	FRN0840G2E-4G	FRN1169G2E-4G		
500(800)			FRN1039G2E-4G	FRN1385G2E-4G
560(900)	FRN1039G2E-4G	FRN1385G2E-4G	FRN1169G2E-4G	
630(900)	FRN1169G2E-4G		FRN1385G2E-4G	FRN1480G2E-4G
710(1200)	FRN1385G2E-4G	FRN1480G2E-4G	FRN1480G2E-4G	
800(1300)	FRN1480G2E-4G			

How to read the inverter modeler model

FRN 0003 G 2 S - 4 G

Code	Series name	Code	Destination
FRN	FRENIC series	G	Global
Code	Applicable motor rating	Code	Input power source
0002	0.4kW (1/2HP)	4	3-phase 400V
I	I	2	3-phase 200V
1386	630kW (900HP), 710kW (1000HP)	Code	Enclosure
Code	Applicable range	S	Standard (basic type)
G	High performance, multifunctional type	E	EMC filter built-in type
Code	Order of development	2	Series

Standard Specifications

Basic type

Three-phase 200V series

Item			Specifications																																				
Type (FRN□□□□G2S-2G)			0003	0005	0008	0011	0018	0032	0046	0059	0075	0088	0115	0146	0180	0215	0288	0346	0432																				
Standard applicable motor (*1)	kW	HHD	0.4	0.75	1.5	2.2	3.7	5.5	7.5	11	15	18.5	22	30	37	45	55	75	90																				
		HND	-	-	-	-	-	7.5	11	15	18.5	22	30	37	45	55	75	90	110																				
	HP	HHD	1/2	1	2	3	5	7.5	10	15	20	25	30	40	50	60	75	100	125																				
		HND	-	-	-	-	-	10	15	20	25	30	40	50	60	75	100	125	150																				
Output ratings	Rated capacity [kVA] (*2)		HHD	1.1	1.9	3.0	4.1	6.8	10	14	18	24	28	34	45	55	68	81	109	131																			
			HND	-	-	-	-	-	12	17	22	28	33	43	55	68	81	109	131	164																			
	Rated current [A] (at Ta=50°C(122°F))		HHD	3	5	8	11	18	27	37	49	63	76	90	119	146	180	215	288	346																			
			HND	-	-	-	-	-	31.8	46.2	59.4	74.8	88	115	146	180	215	288	346	432																			
	Rated voltage [V] (*3)		Three-phase 200 to 240 V (with AVR function)											Three-phase 200 to 230 V (with AVR function)																									
	Overload current rating [A] (permissible overload time)		HHD	150% for 1 minute, 200% for 3 seconds																																			
			HND	120% for 1 minute																																			
	Ambient temperature		HHD	-10 to +55 °C [14 to 131 °F] (current derating necessary in +50 to +55 °C [122 to 131 °F] range)																																			
		HND	-10 to +55 °C [14 to 131 °F] (current derating necessary in +50 to +55 °C [122 to 131 °F] range)																																				
Rated frequency [Hz]		50/60 Hz																																					
Voltage, frequency		Three-phase 200 to 240 V, 50/60 Hz											Three-phase 200 to 230 V, 50/60 Hz																										
Voltage, frequency fluctuation		Voltage: +10 to -15% (interphase unbalance ratio: 2% or less) (*5), Frequency: +5 to -5 %																																					
Input ratings	Rated current [A] (*6)	With DCR	HHD	1.6	3.2	6.1	8.9	15.0	21.1	28.8	42.2	57.6	71.0	84.4	114	138	167	203	282	334																			
		HND	-	-	-	-	-	28.8	42.2	57.6	71	84.4	114	138	167	203	282	334	410																				
	Without DCR	HHD	3.1	5.3	9.5	13.2	22.2	31.5	42.7	60.7	80.1	97.0	112	151	185	225	270	-	-																				
	HND	-	-	-	-	-	42.7	60.7	80.1	97	112	151	185	225	270	-	-	-																					
Required power supply capacity (with DCR) [kVA] (*7)		HHD	0.6	1.2	2.2	3.1	5.2	7.4	10	15	20	25	30	40	48	58	71	98	116																				
		HND	-	-	-	-	-	10	15	20	25	30	40	48	58	71	98	116	143																				
Auxiliary control power supply voltage		Single-phase 200 to 240 V, 50/60 Hz											Single-phase 200 to 230 V, 50/60 Hz																										
Braking	Torque [%] (*8)		HHD	150	100	-	-	-	-	20	-	-	-	10 to 15	-	-	-	-	-																				
			HND	-	-	-	-	-	70	15	-	-	-	7 to 12	-	-	-	-	-																				
	Braking transistor		Built-in																	Option																			
	Minimum connectable resistance value [Ω]		100			40			24			16			12			8			6			4			2.5			2.25			2			1.6			-
	Built-in braking resistor [Ω]		100			40			20			Option																											
	Time [s]	HHD	5																																				
		HND	-																																				
	%ED	HHD	5	3	5	3	2	3	3	2	-																												
HND		-																																					
DC reactor (DCR)		HHD	Option																	Option (*9)																			
		HND	Option																	Option (*9)																			
Protective construction (IEC 60529)		IP20 enclosed type, UL open type											IP00 open type, UL open type IP55 at external side when external cooling installed																										
Cooling system		Natural cooling							Fan cooling																														
Weight [kg(lbs)]		1.7 (3.6)	1.9 (4.2)	2.6 (5.7)	2.9 (6.3)	2.9 (6.4)	5.8 (13)	6.2 (14)	5.7 (13)	11 (23)	11 (24)	12 (25)	23 (51)	31 (68)	40 (88)	42 (93)	60 (132)	97 (214)																					

(*1) Standard applicable motor indicates Fuji Electric 4-pole standard motors. Select a motor not only based on inverter output (kW), but also so that the output rated current is greater than the motor rated current.

(*2) The rated capacity indicates 220 V for the 200 V series, and 440 V for the 400 V series.

(*3) It is not possible to output a voltage higher than the power supply voltage.

(*5) Interphase unbalance ratio [%] = (Max. voltage [V] - min. voltage [V]) / Three-phase average voltage [V] x 67 (see IEC/EN 61800-3).

If using the motor with an unbalance ratio of 2 to 3%, use an AC reactor (ACR: option).

(*6) This indicates the estimated value if the power supply capacity is 500 kVA (10 times inverter capacity if inverter capacity exceeds 50 kVA), and the motor is connected to a power supply of %X = 5%.

(*7) This indicates the capacity when the motor is equipped with a DC reactor (DCR).

(*8) This is the average braking torque when performing individual operation. (This will vary based on the motor efficiency.)

(*9) When applying a motor of 75kW or more, be sure to use a DC reactor (option).

Three-phase 400V series

Item			Specification																						
Type (FRN□□□□G2S-4G)			0002	0003	0004	0006	0009	0018	0023	0035	0041	0045	0060	0085	0105	0139									
Standard applicable motor (*1)	kW	HHD	0.4	0.75	1.5	2.2	3.7	5.5	7.5	11	15	18.5	22	30	37	45									
		HND							7.5	11	15	18.5	22	30	37	45	55								
		HD																							
		ND																							
	HP	HHD	1/2	1	2	3	5	7.5	10	15	20	25	30	40	50	60									
		HND	-	-	-	-	-	10	15	20	25	30	40	50	60	75									
		HD																							
		ND																							
Output ratings	Rated capacity [kVA] (*2)		HHD	1.1	1.9	3.2	4.5	6.8	10	14	18	24	29	34	45	57	69								
			HND							13	17	26	31	34	45	57	69	85							
			HD																						
			ND																						
	Rated current [A] (at Ta=50°C(122°F))		HHD	1.5	2.5	4.2	6.0	9.0	13.5	18.5	24.5	32	39	45	60	75	91								
			HND							17.5	23	35	41	45	60	75	91	112							
	Rated current [A] (at Ta=40°C(104°F))		HD																						
	Rated voltage [V] (*3)		ND																						
	Overload current rating [A] (permissible overload time)		Three-phase 380 to 480 V (with AVR function)																						
			150% for 1 minute, 200% for 3 seconds																						
			120% for 1 minute																						
			150% for 1 minute																						
Ambient temperature		HHD	-10 to +55 °C [14 to 131 °F] (current derating necessary in +50 to +55 °C [122 to 131 °F] range)																						
		HND							-10 to +55 °C [14 to 131 °F] (current derating necessary in +50 to +55 °C [122 to 131 °F] range)																
		HD																							
		ND																							
Rated frequency [Hz]		50/60 Hz																							
Voltage, frequency		Three-phase 380 to 480 V, 50/60 Hz																							
Voltage, frequency fluctuation		Voltage: +10 to -15% (interphase unbalance ratio: within 2%)(*5), Frequency: +5 to -5 %																							
Input ratings	Rated current [A] (*6)		With DCR	HHD	0.85	1.6	3.0	4.5	7.5	10.6	14.4	21.1	28.8	35.5	42.2	57.0	68.5	83.2							
				HND							14.4	21.1	28.8	35.5	42.2	57	68.5	83.2	102						
				HD																					
				ND																					
	Without DCR	HHD	1.7	3.1	5.9	8.2	13	17.3	23.2	33	43.8	52.3	60.6	77.9	94.3	114									
		HND							23.2	33	43.8	52.3	60.6	77.9	94.3	114	140								
		HD																							
		ND																							
	Required power supply capacity (with DCR) [kVA] (*7)		HHD	0.6	1.2	2.1	3.2	5.2	7.4	10	15	20	25	30	40	48	58	71							
			HND							10	15	20	25	30	40	48	58	71							
HD																									
ND																									
Auxiliary control power supply voltage					Single-phase 380 to 480 V, 50/60 Hz																				
Torque [%] (*8)		HHD	150		100					20				10 to 15											
		HND							70			15													
		HD																							
		ND																							
Braking transistor		Built-in as standard																							
Minimum connectable resistance value [Ω]		200			160			96		64		48		32		24		16		10		9.0		8.0	
Built-in braking resistor [Ω]		720		470		160		80								Option									
Braking	Time [s]	HHD	5																						
			HND							3.7		3.4													
		HD																							
			ND																						
%ED	HHD	5			3		5		3		2		3		2										
		HND							2.2		1.4														
	HD																								
		ND																							

(*1) Standard applicable motor indicates Fuji Electric 4-pole standard motors. Select a motor not only based on inverter output (kW), but also so that the output rated current is greater than the motor rated current.

(*2) The rated capacity indicates 220 V for the 200 V series, and 440 V for the 400 V series.

(*3) It is not possible to output a voltage higher than the power supply voltage.

(*5) Interphase unbalance ratio [%] = (Max. voltage [V] - min. voltage [V])/Three-phase average voltage [V] x 67 (see IEC/EN 61800-3).

If using the motor with an unbalance ratio of 2 to 3%, use an AC reactor (ACR: option).

(*6) This indicates the estimated value if the power supply capacity is 500 kVA (10 times inverter capacity if inverter capacity exceeds 50 kVA), and the motor is connected to a power supply of %X = 5%.

(*7) This indicates the capacity when the motor is equipped with a DC reactor (DCR).

(*8) This is the average braking torque when performing individual operation. (This will vary based on the motor efficiency.)

Standard Specifications

Basic type

Three-phase 400V series

Item		Specification													
Type (FRN□□□□G2S-4G)		0002	0003	0004	0006	0009	0018	0023	0035	0041	0045	0060	0085	0105	0139
DC reactor (DCR)	HHD	Option													
	HND	Option													
	HD	-											Option		
	ND	-											Option	Option (*9)	
Protective construction (IEC 60529)		IP20 enclosed type, UL open type											IP00 open type, UL open type IP55 at external side when external cooling installed		
Cooling system		Natural cooling					Fan cooling								
Weight [kg(lbs)]		1.7 (3.7)	2.0 (4.3)	2.6 (5.8)	2.9 (6.4)	3.0 (6.6)	5.9 (13)	6.0 (13)	5.7 (13)	10 (23)	11 (23)	11 (23)	23 (51)	23 (51)	28 (62)

(*1) Standard applicable motor indicates Fuji Electric 4-pole standard motors. Select a motor not only based on inverter output (kW), but also so that the output rated current is greater than the motor rated current.

(*2) The rated capacity indicates 220 V for the 200 V series, and 440 V for the 400 V series.

(*3) It is not possible to output a voltage higher than the power supply voltage.

(*5) Interphase unbalance ratio [%] = (Max. voltage [V] - min. voltage [V]) / Three-phase average voltage [V] x 67 (see IEC/EN 61800-3).

If using the motor with an unbalance ratio of 2 to 3%, use an AC reactor (ACR: option).

(*6) This indicates the estimated value if the power supply capacity is 500 kVA (10 times inverter capacity if inverter capacity exceeds 50 kVA), and the motor is connected to a power supply of %X = 5%.

(*7) This indicates the capacity when the motor is equipped with a DC reactor (DCR).

(*8) This is the average braking torque when performing individual operation. (This will vary based on the motor efficiency.)

(*9) When applying a motor of 75kW or more, be sure to use a DC reactor (option).

Basic type

Three-phase 400V series

Item			Specification															
Type (FRN □□□□ G2S-4G)			0179	0217	0261	0290	0376	0431	0547	0610	0739	0840	1039	1169	1385	1480		
Standard applicable motor (*1)	kW	HHD	55	75	90	110	132	160	200	220	280	315	355	400	500	630		
		HND	75	110	132	160	200	220	280	315	355	400	500	560	630	710		
		HD	75	90	110	132	160	200	220	250	315	355	400	450	560	710		
		ND	90	110	132	160	200	220	280	315	400	450	560	630	710	800		
	HP	HHD	75	100	125	150	200	250	300	350	400	450	500	600	800	900		
		HND	100	150	200	200	300	350	450	500	500	600	700	800	900	1000		
		HD	100	150	150	200	250	300	350	400	450	500	600	700	900	1200		
		ND	125	150	200	200	300	350	450	500	600	700	900	900	1200	1300		
	Output ratings	Rated capacity [kVA] (*2)		HHD	85	114	137	164	198	247	287	329	396	445	495	563	731	891
				HND	114	165	198	221	275	316	416	464	495	563	731	792	891	1056
				HD	114	137	165	198	247	287	329	363	445	495	563	640	792	1056
				ND	136	165	198	221	286	328	416	464	563	640	791	890	1055	1127
Rated current [A] (at Ta=50°C(122°F))		HHD	112	150	180	216	260	325	377	432	520	585	650	740	960	1170		
		HND	150	217	261	290	361	415	547	610	650	740	960	1040	1170	1386		
Rated current [A] (at Ta=40°C(104°F))		HD	150	180	217	261	325	377	432	477	585	650	740	840	1040	1386		
		ND	179	217	261	290	376	431	547	610	739	840	1039	1169	1385	1480		
Rated voltage [V] (*3)		Three-phase 380 to 480 V (with AVR function)																
Overload current rating[A] (permissible overload time)		HHD	150% for 1 minute, 200% for 3 seconds															
		HND	120% for 1 minute															
		HD	150% for 1 minute															
		ND	120% for 1 minute															
Ambient temperature		HHD	-10 to +55 °C [14 to 131 °F] (current derating necessary in +50 to +55 °C [122 to 131 °F] range)															
		HND	-10 to +55 °C [14 to 131 °F] (current derating necessary in +50 to +55 °C [122 to 131 °F] range)															
		HD	-10 to +55 °C [14 to 131 °F] (current derating necessary in +40 to +55 °C [104 to 131 °F] range)															
		ND	-10 to +55 °C [14 to 131 °F] (current derating necessary in +40 to +55 °C [104 to 131 °F] range)															
Rated frequency [Hz]		50/60 Hz																
Voltage, frequency		Three-phase 380 to 480 V, 50/60 Hz																
Voltage, frequency fluctuation		Voltage: +10 to -15% (interphase unbalance ratio: within 2%)(*5), Frequency: +5 to -5 %																
Input ratings	Rated current [A](*6)	With DCR	HHD	102	138	164	201	238	286	357	390	500	559	628	705	881	1115	
			HND	138	201	238	286	357	390	500	559	628	705	881	990	1115	1256	
			HD	138	164	201	238	286	357	390	443	559	628	705	789	990	1256	
			ND	164	201	238	286	357	390	500	559	705	789	990	1115	1256	1415	
		Without DCR	HHD	140	-	-	-	-	-	-	-	-	-	-	-	-	-	
			HND	-	-	-	-	-	-	-	-	-	-	-	-	-	-	
			HD	-	-	-	-	-	-	-	-	-	-	-	-	-	-	
			ND	-	-	-	-	-	-	-	-	-	-	-	-	-	-	
	Required power supply capacity (with DCR) [kVA] (*7)		HHD	71	96	114	140	165	199	248	271	347	388	436	489	611	773	
			HND	96	140	165	199	248	271	347	388	436	489	611	686	773	871	
			HD	96	114	140	165	199	248	271	307	388	436	489	547	686	871	
			ND	114	140	165	199	248	271	347	388	489	547	686	773	871	981	
Auxiliary control power supply voltage		Single-phase 380 to 480 V, 50/60 Hz																
Braking	Torque [%] (*8)		HHD	10 to 15														
			HND	7 to 12														
			HD	7 to 12														
			ND	7 to 12														
	Braking transistor		Built-in			Option												
	Minimum connectable resistance value [Ω]		6.5	4.7	-													
	Built-in braking resistor [Ω]		Option															
	Time [s]		-															
	%ED		-															
	DC reactor (DCR)		HHD	Option(*9)														
			HND	Option(*9)														
			HD	Option(*9)														
		ND	Option(*9)															
Protective construction (IEC 60529)		IP00 open type, UL open type IP55 at external side when external cooling installed																
Cooling system		Fan cooling																
Weight [kg(lbs)]		31 (68)	38 (84)	60 (132)	60 (132)	89 (196)	89 (196)	116 (256)	124 (273)	221 (487)	221 (487)	291 (642)	295 (650)	450 (992)	450 (992)			

(*1) Standard applicable motor indicates Fuji Electric 4-pole standard motors. Select a motor not only based on inverter output (kW), but also so that the output rated current is greater than the motor rated current.
 (*2) The rated capacity indicates 220 V for the 200 V series, and 440 V for the 400 V series.
 (*3) It is not possible to output a voltage higher than the power supply voltage.
 (*4) Interphase unbalance ratio [%] = (Max. voltage [V] - min. voltage [V])/Three-phase average voltage [V] x 67 (see IEC/EN 61800-3).
 If using the motor with an unbalance ratio of 2 to 3%, use an AC reactor (ACR: option).
 (*5) This indicates the estimated value if the power supply capacity is 500 kVA (10 times inverter capacity if inverter capacity exceeds 50 kVA), and the motor is connected to a power supply of %X = 5%.
 (*6) This indicates the capacity with a DC reactor (DCR).
 (*7) This is the average braking torque during standalone operation. (This will vary based on the motor efficiency.)
 (*8) This is the average braking torque during standalone operation. (This will vary based on the motor efficiency.)
 (*9) When applying a motor of 75kW or more, be sure to use a DC reactor (option).

Features
Main application examples
Model variations
Type number nomenclature
Standard specifications
Common specifications
Terminal specifications
Basic wiring diagram
External dimensions
Keypad
Function codes
Options
Product warranty

Standard Specifications

EMC filter Built-in type

Three-phase 400V series

Item			Specification														
Type (FRN □□□□ G2E-4G)			0002	0003	0004	0006	0009	0018	0023	0035	0041	0045	0060	0085	0105	0139	
Standard applicable motor (*1)	kW	HHD	0.4	0.75	1.5	2.2	3.7	5.5	7.5	11	15	18.5	22	30	37	45	
		HND	-	-	-	-	-	7.5	11	15	18.5	22	30	37	45	55	
		ND	-	-	-	-	-	-	-	-	-	-	-	37	45	55	
	HP	HHD	1/2	1	2	3	5	7.5	10	15	20	25	30	40	50	60	
		HND	-	-	-	-	-	10	15	20	25	30	40	50	60	75	
		ND	-	-	-	-	-	-	-	-	-	-	-	50	60	75	
Output ratings	Rated capacity [kVA] (*2)	HHD	1.1	1.9	3.2	4.5	6.8	10	14	18	24	29	34	45	57	69	
		HND	-	-	-	-	-	13	17	26	31	34	45	57	69	85	
		HD	-	-	-	-	-	-	-	-	-	-	-	57	69	85	
		ND	-	-	-	-	-	-	-	-	-	-	-	64	80	105	
	Rated current [A] (at Ta=50°C(122°F))	HHD	1.5	2.5	4.2	6.0	9.0	13.5	18.5	24.5	32	39	45	60	75	91	
		HND	-	-	-	-	-	17.5	23	35	41	45	60	75	91	112	
	Rated current [A] (at Ta=40°C(104°F))	HD	-	-	-	-	-	-	-	-	-	-	-	75	91	112	
		ND	-	-	-	-	-	-	-	-	-	-	-	85	105	139	
	Overload current rating [A] (permissible overload time)	HDD	Three-phase 380 to 480 V (with AVR function)														
			150% for 1 minute, 200% for 3 seconds														
			120% for 1 minute														
			150% for 1 minute														
	Ambient temperature	HDD	-10 to +55 °C [14 to 131 °F] (current derating necessary in +50 to +55 °C [122 to 131 °F] range)														
			-10 to +55 °C [14 to 131 °F]														
			(current derating necessary in +50 to +55 °C [122 to 131 °F] range)														
			-10 to +55 °C [14 to 131 °F] (current derating necessary in +40 to +55 °C [104 to 131 °F] range)														
	Input ratings	Rated frequency [Hz]	50/60 Hz														
			Three-phase 380 to 480 V, 50/60 Hz														
Voltage, frequency fluctuation		Voltage: +10 to -15% (interphase unbalance ratio: within 2%)*5, Frequency: +5 to -5 %															
		Rated current [A] (*6)	With DCR	HHD	0.85	1.6	3.0	4.5	7.5	10.6	14.4	21.1	28.8	35.5	42.2	57.0	68.5
HND				-	-	-	-	-	14.4	21.1	28.8	35.5	42.2	57.0	68.5	83.2	102
ND				-	-	-	-	-	-	-	-	-	-	-	68.5	83.2	102
Without DCR			HHD	1.7	3.1	5.9	8.2	13	17.3	23.2	33	43.8	52.3	60.6	77.9	94.3	114
			HND	-	-	-	-	-	23.2	33	43.8	52.3	60.6	77.9	94.3	114	140
			ND	-	-	-	-	-	-	-	-	-	-	-	94.3	114	140
Required power supply capacity (with DCR) [kVA] (*7)		HHD	0.6	1.2	2.1	3.2	5.2	7.4	10	15	20	25	30	40	48	58	
		HND	-	-	-	-	-	10	15	20	25	30	40	48	58	71	
		ND	-	-	-	-	-	-	-	-	-	-	-	48	58	71	
Auxiliary control power supply voltage		Single-phase 380 to 480 V, 50/60 Hz															
		Torque [%] (*8)	HHD	150	100	70	70	70	70	70	70	70	70	70	70	70	70
			HND	-	-	-	-	-	70	70	70	70	70	70	70	70	70
HD			-	-	-	-	-	-	-	-	-	-	-	70	70	70	
ND			-	-	-	-	-	-	-	-	-	-	-	70	70	70	
Braking		Braking transistor	Built-in as standard														
	Minimum connectable resistance value [Ω]																
	Built-in braking resistor [Ω]	HHD	200	160	96	64	48	32	24	16	10	9.0	8.0	Option			
		HND	720	470	160	80	80	Option									
	%ED	Time [s]	HHD	5	3	2	3	2	3	2	-						
			HND	-	-	-	3.7	3.4	-								
HD			-	-	-	-	-	-									
ND			-	-	-	-	-	-									
EMC filter	Emissions: EN 61800-3:2004/A1:2012 Category C3																
	Immunity: 2nd Env.																
	Option																
DC reactor (DCR)	HHD	Option													Option		
	HND	Option													Option		
	HD	Option													Option		
	ND	Option													Option (*9)		
Protective construction (IEC 60529)	IP20 enclosed type, UL open type													IP00 open type, UL open type			
														IP55 at external side when external cooling installed			
Cooling system	Natural cooling						Fan cooling										
	Weight [kg(lbs)]	1.7 (3.7)	2.0 (4.3)	2.6 (5.8)	2.9 (6.4)	3.0 (6.6)	5.9 (13)	6.0 (13)	5.7 (13)	10 (23)	11 (23)	11 (23)	23 (51)	23 (51)	28 (62)		

(*1) Standard applicable motor indicates Fuji Electric 4-pole standard motors. Select a motor not only based on inverter output (kW), but also so that the output rated current is greater than the motor rated current.

(*2) The rated capacity indicates 220 V for the 200 V series, and 440 V for the 400 V series.

(*3) It is not possible to output a voltage higher than the power supply voltage.

(*4) Interphase unbalance ratio [%] = (Max. voltage [V] - min. voltage [V]) / Three-phase average voltage [V] x 67 (see IEC/EN 61800-3).

(*5) If using the motor with an unbalance ratio of 2 to 3%, use an AC reactor (ACR: option).

(*6) This indicates the estimated value if the power supply capacity is 500 kVA (10 times inverter capacity if inverter capacity exceeds 50 kVA), and the motor is connected to a power supply of %X = 5%.

(*7) This indicates the capacity when the motor is equipped with a DC reactor (DCR)

(*8) This is the average braking torque when performing individual operation. (This will vary based on the motor efficiency.)

(*9) When applying a motor of 75kW or more, be sure to use a DC reactor (option).

EMC filter Built-in type









Three-phase 400V series

Item		Specification															
Type (FRN □□□□ G2E-4G)		0179	0217	0261	0290	0376	0431	0547	0610	0739	0840	1039	1169	1385	1480		
Standard applicable motor (*1)	kW	HHD	55	75	90	110	132	160	200	220	280	315	355	400	500	630	
		HND	75	110	132	160	200	220	280	315	355	400	500	560	630	710	
		HD	75	90	110	132	160	200	220	250	315	355	400	450	560	710	
		ND	90	110	132	160	200	220	280	315	400	450	560	630	710	800	
	HP	HHD	75	100	125	150	200	250	300	350	400	450	500	600	800	900	
		HND	100	150	200	200	300	350	450	500	500	600	700	800	900	1000	
		HD	100	150	150	200	250	300	350	400	450	500	600	700	900	1200	
		ND	125	150	200	200	300	350	450	500	600	700	900	900	1200	1300	
Output ratings	Rated capacity [kVA] (*2)	HHD	85	114	137	164	198	247	287	329	396	445	495	563	731	891	
		HND	114	165	198	221	275	316	416	464	495	563	731	792	891	1056	
		HD	114	137	165	198	247	287	329	363	445	495	563	640	792	1056	
		ND	136	165	198	221	286	328	416	464	563	640	791	890	1055	1127	
	Rated current [A] (at Ta=50°C(122°F))	HHD	112	150	180	216	260	325	377	432	520	585	650	740	960	1170	
		HND	150	217	261	290	361	415	547	610	650	740	960	1040	1170	1386	
	Rated current [A] (at Ta=40°C(104°F))	HD	150	180	217	261	325	377	432	477	585	650	740	840	1040	1386	
		ND	179	217	261	290	376	431	547	610	739	840	1039	1169	1385	1480	
	Single-phase Input	Rated capacity [kVA] (*2)	HHD														
		Rated current [A] (at Ta=50°C(122°F))	HHD														
	Rated voltage [V] (*3)		Three-phase 380 to 480 V (with AVR function)														
	Overload current rating [A] (permissible overload time)	HHD	150% for 1 minute, 200% for 3 seconds														
HND		120% for 1 minute															
HD		150% for 1 minute															
ND		120% for 1 minute															
Ambient temperature	HHD	-10 to +55 °C [14 to 131 °F] (current derating necessary in +50 to +55 °C [122 to 131 °F] range)															
	HND	-10 to +55 °C [14 to 131 °F] (current derating necessary in +50 to +55 °C [122 to 131 °F] range)															
	HD	-10 to +55 °C [14 to 131 °F] (current derating necessary in +40 to +55 °C [104 to 131 °F] range)															
	ND	-10 to +55 °C [14 to 131 °F] (current derating necessary in +40 to +55 °C [104 to 131 °F] range)															
Rated frequency [Hz]		50/60 Hz															
Voltage, frequency		Three-phase 380 to 480 V, 50/60 Hz															
Voltage, frequency fluctuation		Voltage: +10 to -15% (interphase unbalance ratio: within 2%) (*5), Frequency: +5 to -5 %															
Input ratings	Rated current [A] (*6)	With DCR	HHD	102	138	164	201	238	286	357	390	500	559	628	705	881	
			HND	138	201	238	286	357	390	500	559	628	705	881	990	1115	1256
		Without DCR	HD	138	164	201	238	286	357	390	443	559	628	705	789	990	1256
			ND	164	201	238	286	357	390	500	559	705	789	990	1115	1256	1415
	Required power supply capacity (with DCR) [kVA] (*7)	HHD	140	-	-	-	-	-	-	-	-	-	-	-	-	-	
		HND	-	-	-	-	-	-	-	-	-	-	-	-	-	-	
		HD	-	-	-	-	-	-	-	-	-	-	-	-	-	-	
		ND	-	-	-	-	-	-	-	-	-	-	-	-	-	-	
Auxiliary control power supply voltage		Single-phase 380 to 480 V, 50/60 Hz															
Braking	Torque [%] (*8)	HHD	10 to 15														
		HND	7 to 12														
		HD	7 to 12														
		ND	7 to 12														
Braking transistor		Built-in		Option													
Minimum connectable resistance value [Ω]		6.5	4.7	-													
Built-in braking resistor [Ω]		Option															
Time [s]		-															
%ED		-															
EMC filter		Emissions: EN 61800-3:2004/A1:2012 Category C3 Immunity: 2nd Env.															
DC reactor (DCR)	HHD	Option	Optio (*9)														
	HND	Option (*9)															
	HD	Option (*9)															
	ND	Option (*9)															
Protective construction (IEC 60529)		IP00 open type, UL open type IP55 at external side when external cooling installed															
Cooling system		Fan cooling															
Weight [kg/(lbs)]		31 (68)	38 (84)	60 (132)	60 (132)	89 (196)	89 (196)	116 (256)	124 (273)	221 (487)	221 (487)	291 (642)	295 (650)	450 (992)	450 (992)		



(*1) Standard applicable motor indicates Fuji Electric 4-pole standard motors. Select a motor not only based on inverter output (kW), but also so that the output rated current is greater than the motor rated current.
 (*2) The rated capacity indicates 220 V for the 200 V series, and 440 V for the 400 V series.
 (*3) It is not possible to output a voltage higher than the power supply voltage.
 (*4) Interphase unbalance ratio [%] = (Max. voltage [V] - min. voltage [V])/Three-phase average voltage [V] x 67 (see IEC/EN 61800-3).
 If using the motor with an unbalance ratio of 2 to 3%, use an AC reactor (ACR: option).
 (*5) This indicates the estimated value if the power supply capacity is 500 kVA (10 times inverter capacity if inverter capacity exceeds 50 kVA), and the motor is connected to a power supply of %X = 5%.
 (*6) This indicates the capacity with a DC reactor (DCR).
 (*7) This is the average braking torque during standalone operation. (This will vary based on the motor efficiency.)
 (*8) This is the average braking torque during standalone operation. (This will vary based on the motor efficiency.)
 (*9) When applying a motor of 75kW or more, be sure to use a DC reactor (option).

Features
Main application examples
Model variations
Type number nomenclature
Standard specifications
Common specifications
Terminal specifications
Basic wiring diagram
External dimensions
Keypad
Function codes
Options
Product warranty

Common Specifications

Item		Explanation	Remarks	
Adjustment	Maximum output frequency	5 to 599 Hz variable setting		
	Base frequency	5 to 599 Hz variable setting (in conjunction with maximum output frequency)		
	Number of motor poles setting	2 to 128 poles		
	Starting frequency	0.1 to 60.0 Hz variable setting (0.0 Hz when performing speed sensorless vector control/vector control with speed sensor)		
Output	Carrier frequency	<ul style="list-style-type: none"> • 0.75 to 16 kHz variable setting HHD specification: 0.4 to 55 kW (type: 0003 to 0288 (200 V), type: 0002 to 0179 (400 V)) HND specification: 5.5 to 18.5 kW (type: 0032 to 0088 (200 V), type: 0018 to 0045 (400 V)) • 0.75 to 10 kHz variable setting HHD specification: 75 to 630 kW (type: 0346 to 0432 (200 V), type: 0217 to 1480 (400 V)) HND specification: 22 to 55 kW (type: 0115 to 0288 (200 V), type: 0060 to 0179 (400 V)) HD specification: 30 to 55 kW (type: 0085 to 0179 (400 V)) • 0.75 to 6 kHz variable setting HND specification: 75 to 630 kW (type: 0346 to 0432 (200 V), type: 0217 to 1480 (400 V)) HD specification: 75 to 630 kW (type: 0217 to 1480 (400 V)) ND specification: 30 to 630 kW (type: 0085 to 1480 (400 V)) <p>Note) The carrier frequency may automatically lower depending upon the ambient temperature or the output current to protect the inverter. (The automatic lowering function can be disabled.)</p>		
	Output frequency accuracy	<ul style="list-style-type: none"> • Analog setting : $\pm 0.2\%$ of maximum output frequency (at $25 \pm 10^\circ\text{C}$) ($77 \pm 18^\circ\text{F}$) • Keypad setting : $\pm 0.01\%$ of maximum output frequency (at 10 to $+50^\circ\text{C}$) ($14 \pm 22^\circ\text{F}$) 		
Synchronous motors	Frequency setting resolution	<ul style="list-style-type: none"> • Analog setting : $1/3000$ of maximum output frequency • Keypad setting : 0.01 Hz • Link setting : $1/20000$ of maximum output frequency or 0.01 Hz (fixed) 		
	When performing V/f control with sensor*1 When performing dynamic torque vector control with sensor*2	Speed control Range	<ul style="list-style-type: none"> • 1:20*1, 1:200*2 (Minimum speed: Nominal speed) • 1:2 (fixed torque area : fixed output area) 	
		Speed control accuracy	<ul style="list-style-type: none"> • Analog setting: $\pm 0.2\%$ of maximum output frequency or below (at $25 \pm 10^\circ\text{C}$) • Digital setting: $\pm 0.01\%$ of maximum output frequency or below (at 10 to $+50^\circ\text{C}$) 	
	When performing sensorless vector control	Speed control Range	<ul style="list-style-type: none"> • 1:200 (Minimum speed: Nominal speed) • 1:2 (fixed torque area : fixed output area) 	
		Speed control accuracy	<ul style="list-style-type: none"> • Analog setting: $\pm 0.5\%$ of maximum output frequency or below (at $25 \pm 10^\circ\text{C}$) • Digital setting: $\pm 0.5\%$ of maximum output frequency or below (at 10 to $+50^\circ\text{C}$) 	
	When performing vector control with sensor	Speed control Range	<ul style="list-style-type: none"> • 1:1500 (Minimum speed: Nominal speed) • 1:16 (fixed torque area : fixed output area) 	
		Speed control accuracy	<ul style="list-style-type: none"> • Analog setting: $\pm 0.2\%$ of maximum output frequency or below (at $25 \pm 10^\circ\text{C}$) • Digital setting: $\pm 0.01\%$ of maximum output frequency or below (at 10 to $+50^\circ\text{C}$) 	
	When performing sensorless vector control	Speed control Range	<ul style="list-style-type: none"> • 1:10 (Minimum speed: Nominal speed) • 1:2 (Limited by maximum output voltage) 	
		Speed control accuracy	<ul style="list-style-type: none"> • Analog setting: $\pm 0.5\%$ of nominal speed or below (at $25 \pm 10^\circ\text{C}$) • Digital setting: $\pm 0.5\%$ of nominal speed or below (at 10 to $+50^\circ\text{C}$) 	
	When performing vector control with sensor	Speed control Range	<ul style="list-style-type: none"> • 1:1500 (Minimum speed: Nominal speed) • 1:2 (Limited by maximum output voltage) 	
Speed control accuracy		<ul style="list-style-type: none"> • Analog setting: $\pm 0.2\%$ of maximum output frequency (at $25 \pm 10^\circ\text{C}$) • Digital setting: $\pm 0.01\%$ of maximum output frequency (at 10 to $+50^\circ\text{C}$) 		
Control	Control method	<ul style="list-style-type: none"> • V/f control • Dynamic torque vector control • V/f control with sensor, dynamic torque vector control with sensor • Sensorless vector control • Vector control with sensor • Sensorless vector control (synchronous motors) • Vector control with sensor (synchronous motors) 		
	Voltage/frequency characteristics	200V series	<ul style="list-style-type: none"> • The base frequency and maximum output frequency are common, and the voltage can be set between 80 and 240 V. • AVR control can be turned ON or OFF. • Non linear V/f setting (3 points): The desired voltage (0 to 240 V) and frequency (0 to 599 Hz) can be set. 	
		400V series	<ul style="list-style-type: none"> • The base frequency and maximum output frequency are common, and the voltage can be set between 160 and 500 V. • AVR control can be turned ON or OFF. • Non linear V/f setting (3 points): The desired voltage (0 to 500 V) and frequency (0 to 599 Hz) can be set. 	
	Torque boost	<ul style="list-style-type: none"> • Auto torque boost (for constant torque load) • Manual torque boost: The desired torque boost value (0.0 to 20.0%) can be set. • The applicable load can be selected (for constant torque load, quadratic-torque load) 		
	Starting torque (HHD specification)	<ul style="list-style-type: none"> • FRN0115G2S-2G/FRN0060G2-4G or below 200% or higher, • FRN0146G2S-2G/FRN0085G2-4G or above 180% or higher <p>set frequency: 0.3 Hz, when performing V/f control (base frequency: 50 Hz, slip compensation/auto torque boost)</p>		
Running operation	Key operation:	<ul style="list-style-type: none"> Start and stop with  and  keys (LED keypad) Start and stop with , , and  keys (optional multi-function keypad) 		
	External signals:	Forward (reverse) rotation, start/stop commands [2-wire/3-wire operable], (digital input) coast to stop command, external alarm, alarm reset, etc.		
	Link operation:	Operation through RS-485, field bus communication (option)		
	Run command switching :	Remote/local switching, link switching		
	[RUN] key memory :	Memorizes the state of the  key in the event of a power failure during operation using the keypad, and resumes operation after power is restored.		
Frequency setting	Keypad operation :	Using  and  keys		
	External potentiometer:	Using external frequency command potentiometer (external resistor of 1 to 5 k Ω , 1/2 W)		
	Analog input :	<ul style="list-style-type: none"> Voltage input (terminal [12], [V2], [C1] (V3 function)) 0 to ± 10 VDC (± 5 VDC)/0 to $\pm 100\%$ 0 to $+10$ VDC ($+5$ VDC)/0 to $+100\%$ ($+1$ to $+5$ VDC can also be adjusted with bias, analog input gain) Voltage input (terminal [C1] (C1 function)) 4 to 20 mA DC/0 to 100%, 0 to 20 mA DC/0 to 100% 4 to 20 mA DC/-100 to $+100\%$, 0 to 20 mA DC/-100 to $+100\%$ 		

* For details, refer to the FRENIC-MEGA (G2) User's Manual.

Item		Explanation	Remarks
Frequency setting		UP/DOWN operation: Frequency can be increased or decreased while the digital input signal is ON. The frequency recorded with digital input "STZ" can be cleared.	
		Multistep frequency selection: Selectable from 16 different frequencies (step 0 to 15)	
		Pattern operation: The inverter runs automatically according to the previously specified run time, rotation direction, acceleration/deceleration time and reference frequency. Up to 7 stages can be specified.	
		Link operation: Setting through RS-485, field bus communication (option) (built in as standard)	
		Frequency setting switching: Two types of frequency settings can be switched with an external signal (digital input). Remote/local switching, link switching	
		Auxiliary frequency setting: Can be selected by adding and entering the respective terminal [12], [C1], or [V2] inputs.	
		Operation at a specified ratio: The ratio can be set with an analog input signal..	
		Inverse operation: Can be switched from "0 to +10 VDC/0 to 100%" to "10 to 0 VDC/0 to 100%" from an external source. Can be switched from "4 to 20 mA DC/0 to 100%" to "20 to 4 mA DC/0 to 100%" from an external source. Can be switched from "0 to 20 mA DC/0 to 100%" to "20 to 0 mA DC/0 to 100%" from an external source.	
		Pulse train input: (standard) Pulse input = terminal [X6], [X7], forward/reverse pulse, pulse + rotation direction Complementary output: Max. 100 kHz Open collector output: Max. 30 kHz	
		Pulse train input: (option) PG interface option, forward/reverse pulse, pulse + rotation direction Complementary output: Max. 100 kHz Open collector output: Max. 30 kHz	
Acceleration/ deceleration time		Setting range: Setting range from 0.00 to 6000 s	
		Switching: The four types of acceleration/deceleration time can be set or selected individually (switchable during operation).	
		Acceleration/deceleration pattern: Linear acceleration/Deceleration, S curve acceleration/deceleration (weak, random (weak)), curve line acceleration/deceleration (max. acceleration/deceleration at rated output)	
		Deceleration mode (coast to stop): Shutoff of the run command lets the motor coast to a stop.	
		Forcible stop deceleration time: Deceleration stop in exclusive deceleration time by forced stop (STOP). • Dedicated acceleration/deceleration time for jogging; • It is possible to switch between acceleration/deceleration time = 0 with acceleration/deceleration operation cancel "BPS".	
Frequency limiter (upper limit and lower limit frequencies)		<ul style="list-style-type: none"> Specifies the upper and lower frequencies in Hz. Processing can be selected when the reference frequency is less than the lower limit (F16). (The output frequency will be maintained at the lower limit/motor decelerates and stops.) Setting is possible with analog input (terminal [12], [C1], [V2], [V3]). 	
Frequency/PID command bias		<ul style="list-style-type: none"> Frequency: Set between 0 and ±200% PID command: Set between 0 to ±100% 	
Analog input		<ul style="list-style-type: none"> Gain: Setting range from 0 to 400% Offset: Setting range from 5.0 to +5.0% Filter: Setting range from 0.00 to 5.00s 	
Jump frequency		Six operation points and their common jump width (0 to 30.0 Hz) can be set.	
Ready for jogging		Operation with  key (LED keypad),  or  keys (Multi function keypad), or digital contact inputs "FWD" or "REV" (Exclusive acceleration/deceleration time setting, exclusive frequency setting)	
Restart mode after momentary power failure		<ul style="list-style-type: none"> Trip immediately: Trip immediately at the time of power failure. Trip after recovery from power failure: Coast to a stop at the time of power failure and trip when the power is recovered. Trip after decelerate to stop: Deceleration stop at power failure, and trip after stoppage Continue to run: Operation is continued using the load inertia energy. Start at the frequency selected before momentary power failure: Free run at power failure and start after power recovery at the frequency selected before momentary stop. Start at starting frequency: Free run at power failure and start at the starting frequency after power recovery. Start at frequency of power recovery: Free run at power failure, and start after power recovery by searching for the speed. 	
Current limiting	Hardware current limiter	Current is limited with hardware to prevent overcurrent trip due to high-speed load fluctuations or momentary power failure which cannot be handled with software current limiting. (This limiter can be canceled.)	
	Software current limiter	Automatically reduces the frequency so that the output current becomes lower than the preset operation level. (This limiter can be canceled.) The operation can be selected (operation at constant speed only, operation when accelerating and at constant speed).	
Operation by commercial power supply		<ul style="list-style-type: none"> With commercial power selection commands ("SW50", "SW60"), the inverter outputs 50/60 Hz. Commercial switching sequence built in 	
Slip compensation		Compensates for decrease in speed according to the load.	
Droop control		Decreases the speed according to the load torque.	
Torque limit control		<ul style="list-style-type: none"> Switchable between 1st and 2nd torque limit values. Torque limiting/torque current limiting/power limiting for each quadrant Analog torque limit input 	
PID control		<ul style="list-style-type: none"> PID processor for process control/dancer control Switch normal/inverse operation Command: Keypad, analog input (terminals 12, C1, V2, V3), multi-stage setting (selectable from 3 options), RS-485 communication, fieldbus communication (optional) Feedback value: Analog input (terminals 12, C1, V2, V3) Alarm output (absolute value alarm, deviation alarm) PID feedback error detection Sensor input scaling function Sensor input conversion/calculation function Low liquid level stop function (pressurized operation possible before low liquid level stop) Automatic frequency update function for stoppage due to small water quantity Anti reset wind up function Output limiter Integration reset/hold PID constant auto tuning function for process control PID control Built-in external PID controller: 3 sets 	
Retry		<ul style="list-style-type: none"> Automatically releases the trip state and resumes operation up to the set number of times without outputting a batch alarm even if the protective function to be retried is activated. Can be set up to 20 times (configurable by function code). Can set the wait time before resetting. Can set the alarm to be retried 	



* For details, refer to the FRENIC-MEGA (G2) User's Manual.

Features
Main application examples
Model variations
Type number nomenclature
Standard specifications
Common specifications
Terminal specifications
Basic wiring diagram
External dimensions
Keypad
Function codes
Options
Product warranty

Common Specifications

Item	Explanation	Remarks
Auto search	The motor speed is estimated before startup, and the motor is started without ever stopping the motor while it is idling. (Motor constants must be tuned. Auto tuning (offline))	
Anti regenerative control (Automatic deceleration)	<ul style="list-style-type: none"> If the intermediate DC voltage/torque calculation value reach or exceed the anti regenerative control level when the motor is decelerating, the deceleration time is automatically extended to avoid an overvoltage trip. (Forced deceleration can be set at three or more times the deceleration time.) If the torque calculation value reaches or exceeds the anti regenerative control level during constant speed operation, overvoltage tripping is avoided by performing control to raise the frequency. 	
Deceleration characteristics (Improvement of braking performance)	<ul style="list-style-type: none"> The motor loss is increased during deceleration to reduce the regenerative energy in the inverter to avoid overvoltage trip. Can be set for use with AVR cancellation 	
Auto energy saving operation	Controls the output voltage to minimize the total sum of the motor loss and inverter loss. (Auto energy saving control can be turned ON and OFF from an external source with a digital input signal.)	
Overload prevention control	If the surrounding temperature or IGBT junction temperature increases due to overload, the inverter lowers the output frequency to avoid overload.	
Offline tuning	Tunes the motor while the motor is stopped or running, for setting up motor parameters.	
Offline tuning	This corrects changes in motor constants caused by temperature rise.	
Cooling fan ON OFF control	<ul style="list-style-type: none"> Detects inverter internal temperature and stops cooling fan when the temperature is low. Possible to output a fan control signal to an external device. 	
Motor 1 to 4 settings	<ul style="list-style-type: none"> Switching is possible between 4 motors. It is possible to switch between four types of specific function code data (switching is possible while the motor is running.) The following data can be set for motors 1 to 4: base frequency, rated current, torque boost, electronic thermal slip compensation.	
Universal DI	Transfers the status of an external digital signal connected with the general purpose digital input terminal to the host controller.	
Universal DO	Outputs a digital command signal sent from the host controller to the general purpose digital output terminal.	
Universal AO	Outputs an analog command signal sent from the host controller to the analog output terminal.	
Speed control	<ul style="list-style-type: none"> Selectable among the four set of the auto speed regulator (ASR) parameters. Notch filter for vibration control 	
Line speed control	Regulates the motor speed to keep the peripheral speed constant even if the roll winding diameter changes on machines such as winders and unwinders. Tension can be controlled when used in combination with PID control. (A PG option card is required.)	
Master follower operation	Two motors can be run synchronously using a pulse generator (PG). (A PG option card is required.)	
Pre excitation	Excitation is carried out to create the motor flux before starting the motor.	
Zero speed control	Performs speed control by forcibly setting the speed command to zero.	
Servo lock	Stops the motor and holds the motor in the stopped position.	
DC braking	<ul style="list-style-type: none"> Applies DC current to the motor at the operation start time or at the time of inverter stop to generate braking torque. 	
Mechanical brake control	<ul style="list-style-type: none"> It is possible to output mechanical brake control signals with the brake ON/OFF timing adjusted by the output current, torque commands, output frequency and timer. The output timing of control signals can be adjusted individually when performing Errors can be detected with mechanical brake operation check input signals. 	
Torque control	<ul style="list-style-type: none"> Analog torque command input Speed limit function is provided to prevent the motor from becoming out of control. Torque bias (with analog setting, digital setting) possible 	
Rotation direction limitation	Select either of reverse or forward rotation prevention.	
Motor condensation prevention	Current flows automatically when the motor is stopped, and the motor temperature is raised to prevent condensation.	
Customizable logic	It is possible to select or connect digital logic circuits or analog operation circuits with digital/analog I/O signals, configure a simple relay sequence, and operate it freely. (The maximum number of steps is 260)	
Battery operation	Inverters at which an undervoltage has occurred are run with the battery power. 1.5 to 37 kW (type: 0008 to 0180) (200 V class), 1.5 to 55 kW (type: 0004 to 0179) (400 V class)	
Overload stop function	When used for hoisting applications, the motor stops if the inverter detects excessive torque during ascent. After the overload is detected, operation is possible only in the descend direction.	
Load adaptive control function	If the load is lighter than the preset load level, operation can be performed at a frequency that is the set frequency multiplied by a specified ratio / the maximum allowable frequency depending on the load (e.g., vertical transportation machines, conveyors).	
Position control	<ul style="list-style-type: none"> Absolute/relative positioning is possible using a pulse encoder The stop target position can be set by the user's preferred unit system (using electronic gears) via function code (8 point) communication. Home return, Preset, Clear function, Teaching function Position regulator (APR), Position feed forward function Movable range is settable by overtravel detection and stop function 	
Orientation function	This function makes it possible for rotors such as machine tool spindles and turntables to be positioned. Stop target position can be set by a function code (8 points)	
Pump control	<ul style="list-style-type: none"> Cascade operation (drive motor fixed type: 1+8 units, drive motor circulation type: 4 units (when OPC-RY2 is used)) Operation time equalization function <ul style="list-style-type: none"> Boost function Bite prevention function <ul style="list-style-type: none"> Drought detection function Auxiliary motor control function <ul style="list-style-type: none"> Filter clogging prevention function Check valve protection function <ul style="list-style-type: none"> Large water quantity detection function High-frequency operation detection function 	
Rotary operation	Inverters can be connected to each other using RTU communication (up to 3 units)	
Wet bulb temperature estimation control	This function estimates the wet-bulb temperature in the fan control of the cooling tower and controls the fan so that the cooling water is linked with the outside air (wet-bulb) temperature to suppress unnecessary power consumption.	
Scheduled Operation	By combining with the RTC built into the multifunctional keypad (TP-A2SW), it can run/stop the inverter and output external signals. <ul style="list-style-type: none"> Can set 4 timers per week Can set holidays (20 days per year) Can correct for daylight saving time (DST) 	
Favorites function code	The function code can be registered in "Favorites" and displayed (Applicable to all function codes).	
Data initialization	All function codes and limited function codes can be initialized.(Per motor, non-communication-related, customized logic only, Favorites only)	



* For details, refer to the FRENIC-MEGA (G2) User's Manual.

	Item	Explanation	Remarks	
Control	Simulated operation mode	Sequence check is possible without inverter output.		
	Start check function	To ensure safety, the presence or absence of an operation command is checked at power-on, at alarm reset, and when switching operation command methods. An alarm is displayed if an operation command has been input.		
	Multifunction key	During the operation mode, the multifunction key "M/SHIFT" on LED keypads (TP-E2) can be used as an input method to activate the input terminal function like the X terminal.		
	Traceback	Data (user-selectable) such as frequency, voltage, current, etc., immediately before a trip can be saved and analyzed.		
Display	Running/stopping	Speed monitor (reference frequency, output frequency, motor speed, load shaft speed, line speed, and speed indication percentage), output current [A], output voltage [V], calculated torque [%], power consumption [kW], PID command value, PID feedback value, PID output, load factor [%], motor output [kW], torque current (%), magnetic flux command (%), analog input monitor, input watt hour		
	Inverter lifetime alarm	<ul style="list-style-type: none"> It is judged that the life of main circuit capacitors, electrolytic capacitors on PCBs, IGBT or the cooling fan has been reached. Life alarm information can be output externally. Ambient temperature: 40 °C Load factor: Inverter rated current of 100% (HHD specification), 80% (HND, HD, ND specification) 		
	Cumulative operating status	<ul style="list-style-type: none"> The inverter cumulative running time, cumulative input watt hours, and motor cumulative running time/start count (for each motor) is displayed. A warning is output if the maintenance time or startup count set beforehand is exceeded. 		
	Trip	Displays the cause of a trip.		
	Light alarm	The cause of light alarms is displayed.		
	During operation, when trip occurs	<ul style="list-style-type: none"> Trip history: The cause (code) of the up to the last four trips is retained and displayed. All kinds of running status data for up to the past 10 trips is retained and displayed. Date and time can be displayed in the history by using the clock function (TP-A2SW) 		
Protective functions	Overcurrent protection	Stops the inverter to protect it from overcurrent caused by an overload.		
	Short circuit protection	Stops the inverter to protect it from overcurrent caused by shorting of the output circuit.	OC 1 OC 2 OC 3	
	Ground fault protection	Detects the overcurrent caused by the ground fault of the output circuit and stops the inverter Protection may be disabled if the power is turned ON with the ground fault still occurring.		
		Detects output current zero-phase current, and stops the inverter to protect it from overcurrent caused by an output circuit ground fault. (5.5 kW or higher)	EF	
	Overvoltage protection	Stops the inverter if a DC intermediate circuit overvoltage (400V series: 800 VDC, 200V series: 400 VDC) is detected. The inverter cannot be protected if an excessively large voltage is applied by accident.	OU 1 OU 2 OU 3	
	Undervoltage protection	Stops the inverter if a drop in DC intermediate circuit voltage (400V series: 400 VDC, 200V series: 200 VDC) is detected. However, this is disabled based on the restart after momentary power failure setting. Furthermore, operation is possible (regenerative operation only) at a voltage level lower than that above when performing battery operation.	LU	
	Input phase loss protection	Stops the inverter if input voltage phase loss or interphase unbalance factor is detected. If the load is light, or when a DC reactor is connected, input phase loss may not function.	LI n	
	Output phase loss protection	Stops the inverter if inverter output phase loss is detected during operation. This protective function also functions during auto tuning and during magnetic pole position tuning. (Operation selection possible)	OPL	
	Overheat protection	Stops the inverter if a cooling fan fault, or cooling fin overheating when an overload occurs is detected.	OH 1	
		Stops the inverter if inverter unit internal charging resistor overheating is detected.	OH 3	
		Stops the inverter if inverter unit internal charging resistor overheating is detected.	OH 6	
		By setting the braking resistor electronic thermal overload relay function, the inverter is stopped to protect the braking resistor from overheating.	dbH	
	Inverter overload protection	Stops the inverter if overheating is detected by calculating the IGBT internal temperature from the output current and detected internal temperature.	OL U	
	External alarm input	Stops the inverter and displays an error if a digital input signal (THR) is input.	OH 2	
	Fuse blown	Stops the inverter and displays an error if a fuse is blown inside the inverter. (75 kW or higher (type: 0346 to 0432 (200 V))) (90 kW or higher (type: 0261 to 1480 (400 V)))	FUS	
	Charging circuit fault	Stops the inverter and displays an error if an inverter charging circuit error is detected. (Type: 0008 to 0432(200 V), Type: 0004 to 1480 (400 V))	PbF	
	Braking transistor fault	Stops the inverter and displays an error if a braking transistor error is detected.(Type: 0003 to 0288(200 V), Type: 0002 to 0217(400 V))	dbR	
	Motor protection	Electronic thermal overload relay	Stops the inverter if a motor overload is detected by setting the electronic thermal overload relay. Protects general-purpose motors and inverter motors in the entire frequency range. (The operation level and thermal time constant (0.5 to 75.0 minutes) can be set.)	OL 1 to OL 4
		PTC/NTC thermistor	The motor temperature is detected by the PTC/NTC thermistor, and the inverter is stopped if overheating is detected. To enable this function, connect the PTC/NTC thermistor between terminals [V2] and [11], and enable the switch on the control board.	OH 4
		NTC thermistor wire break	The inverter is stopped and an error is displayed if a wire break is detected at the NTC thermistor connected between terminals [V2] and [11].	nr b
	Memory error	When the power is turned ON, a data check is performed when writing data, and an error is displayed if a memory error is detected	Er 1	
	Keypad communication error	Stops the inverter and displays an error if a communication fault is detected at the keypad during operation.	Er 2	
	CPU error	Stops the inverter and displays an error if a CPU error is detected due to noise, etc.	Er 3	
Option communication error	Stops the inverter and displays an error if a communication error with the inverter unit is detected when using an option.	Er 4		
Option error	Stops the inverter and displays an error if an error is detected at the option side when using an option.	Er 5		
Operation error	 key priority Even when run commands are entered via the terminal block or communication, by pressing the keypad  button, the inverter forcibly decelerates and stops the motor, and an error is displayed after the motor has come to a stop.			
	Start check When the power is turned ON, an alarm is cleared, or when switching the run command method from link operation, the sudden starting of operation is suppressed if a run command has been entered, and an error is displayed to notify the operator.			
	Brake status error Stops the inverter and displays an error if the brake signal (BRKS) output status and brake ON check signal (BRKE) input status do not match.	Er 6		
Tuning error	Stops the inverter and displays an error if tuning failure or interruption is detected during motor constant tuning, or if the tuning result is a defect.	Er 7		
RS485 communication error (COM port 1)	Stops the inverter and displays an error if a communication error is detected when communicating via RS-485 COM port 1.	Er 8		

* For details, refer to the FRENIC-MEGA (G2) User's Manual.

Features
Main application examples
Model variations
Type number nomenclature
Standard specifications
Common specifications
Terminal specifications
Basic wiring diagram
External dimensions
Keypad
Function codes
Options
Product warranty

Common Specifications

Item	Explanation	Remarks
RS485 communication error (COM port 2)	Stops the inverter and displays an error if a communication error is detected when communicating via RS-485 COM port 2.	ErP
Data saving error during undervoltage	Stops the inverter and displays an error if unable to successfully save data when undervoltage protection is triggered.	ErF
Position control error	Stops the inverter and displays an error if the positioning deviation is excessive when the servo lock is applied, or when performing master-follower operation.	Ero
Hardware error	Stops the inverter and displays an error if an inverter internal hardware fault is detected.	ErH
STOP input (EN1, EN2) terminal circuit error	Stops the inverter and displays an error if the inverter detects an EN1 or EN2 terminal circuit mismatch.	ErI
PG wire break	Stops the inverter and displays an error if a pulse encoder wire break is detected. (This function is valid on some PG interface option cards.)	PG
Excessive positioning deviation	Stops the inverter and displays an error if the position deviation is found to be excessive while performing position control.	d0
Overspeed protection	Stops the inverter and displays an error if the following conditions are met. <ul style="list-style-type: none"> • If d35 = 999, the speed detection value is the maximum output frequency x (d32 or d33) x 120% or higher • If d35 ≠ 999, the speed detection value is the maximum output frequency x (d35) or higher • The detection value exceeds 599 Hz 	05
Magnetic pole position detection error	Stops the inverter and displays an error if the signal from the magnetic pole position sensor mounted on the PM motor is abnormal.	ErL
Step-out detection/ detection failure of magnetic pole position at startup	This occurs when a PM motor step-out is detected, or if magnetic pole position detection fails when starting.	ErD
Speed inconsistency/ excessive speed deviation	Stops the inverter and displays an error if the state in which the speed deviation between the command speed and detected speed (ASR feedback) is too great continues for the specified time or longer.	ErE
Password protection	Stops the inverter and displays an error if an attempt is made by a malicious third party to disable the password set by the user.	LoP
Customizable logic error	Stops the inverter and displays an error if an attempt is made to make changes to customizable logic related settings while the inverter is running.	ErI
Simulation failure	A simulation failure can be produced if the keypad  button and  button are held down for 5 seconds or longer. A simulation failure can be produced even if function code H45 is set to "1".	Err
Current input terminal signal line break detection	Stops the inverter and displays an error if a line break is detected when current is less than 2 mA when using the current input terminal (terminal [C1] or [C2]) as current input 4 to 20 mA.	CoF
Customizable logic alarm	An error is displayed if the alarm conditions defined by the user with customizable logic are met. (This is not an error at the inverter itself.)	[RA1] to [RA5]
EN (STO) terminal OFF	This is displayed if the run command turns ON when both terminal [EN1] and [EN2] are OFF, and the inverter is not ready to perform operation (STO status).	EnOFF
Minor failure(Warnings)	Cooling fin overheating (OH1), external alarm (OH2), inverter internal overheating (OH3), charging resistor overheating (OH6), braking resistor overheating (dbH), thermistor (NTC) wire break (nrB), motor overload (OL1 to OL4), option communication error (Er4), option error (Er5), RS-485 communication error (COM port 1) (Er8), RS-485 communication error (COM port 2) (ErP), master-follower synchronization error (Ero), position control error (d0), speed does not reach (ErE)/excessive speed deviation (ErE), current input (terminal [C1]/[C2]) wire break detection (CoF), DC fan lock detection (FAL), Excessive position deviation (d0), Low battery warning/Date and time information loss (Lob), PID1 feedback error 1,2(PV1,PV2), Feedback error (External PID)(PVA,PVb,PVC), Dry-run protection(Pdr),Control of maximum starts per hour(roC), End of curve protection (PoL), Filter clogging error(FoL), Impeller anti-jam (rLo), Userdefined alarm (CA1 to CA5)	
	Motor overload early warning	0L
	Cooling fin overheat early warning	0H
	Lifetime warning	LIF
	Reference command loss detected	rEF
	PID warning output	PId
	Low torque detection	uFL
	Overheat warning by PTC thermistor in motor	PfL
	Machine life (Cumulative motor running hours)	rFE
	Inverter life (Number of startups)	LnF
	PID control 1,2 warning output	PR1, PR2
	External PID control1,2,3 warning output	PRR, PRb, PRc
	Follower inverter alarm in mutual operation	SLR
	IGBT lifetime warning	iGb
	Reduced air flow warning	rRF
	Relay signals are output while the inverter is stopped due to an alarm. The alarm is cleared with digital input signal "RST". (Reset the alarm using the [PRG/RESET] key on the optional Multi-function keypad.)	
	Retry	The inverter can be automatically reset allowing it to be restarted when it stops due to a trip.(The number of retries and the latency between stop and reset can be specified.)
Overload prevention control	<ul style="list-style-type: none"> • Overload prevention control (Input phase loss): In case of input missing phase, the output frequency is reduced to reduce the load and operation is continued as long as possible. • Overload prevention control (Low voltage): When the output current increases due to a drop in power supply and an overload condition occurs, the output frequency is reduced to reduce the load and operation is continued as long as possible. 	
Surge protection	This function protects the inverter from a surge voltage between main circuit power lines and the ground.	
Main circuit power cutoff detection	<ul style="list-style-type: none"> • Inverter operation is not possible when the inverter AC input power supply (main power supply) is not ON. • In such cases as when supplying power via a PWM converter or when using a DC bus bar connection, set main circuit power cutoff detection to "None". 	
Forced operation (Fire mode)	Alarms other than critical alarms are ignored, and a retry is performed forcibly.	
Usage location	Indoors (environmental standard IEC60721-3-3:3C2); No corrosive gas, flammable gas, dust, oil mist (pollution level 2 (IEC60664-1)); No direct sunlight	

* For details, refer to the FRENIC-MEGA (G2) User's Manual.

Item		Explanation					Remarks
Environmental	Ambient temperature	HHD, HND: -10 to +55°C [14 to 131°F] (current derating necessary in +50 to +55°C [122 to 131°F] range) HD, ND : -10 to +55°C [14 to 131°F] (current derating necessary in +40 to +55°C [104 to 131°F] range)					
	Ambient humidity	5 to 95% RH (avoid condensation)					
	Altitude	1000 m or less					
	Vibration	Type (voltage series)		2 to less than 9 Hz	9 to less than 20 Hz	20 to less than 55 Hz	55 to 200 Hz
		Type: 0115 or lower (200 V) Type: 0060 or lower (400 V)		3 mm (max. amplitude)	9.8 m/s ²	5.9 m/s ²	1 m/s ²
		Type: 0146 to 0288 (200 V) Type: 0085 to 0217 (400 V)			2 m/s ²	2 m/s ²	
Type: 0346 or higher (200 V) Type: 0261 or higher (400 V)							
Storage temperature	• -25 to +70°C (during transport) • -25 to +65°C (during temporary storage)						
Relative humidity	5 to 95% RH (avoid condensation)						

* For details, refer to the FRENIC-MEGA (G2) User's Manual.

- Features
- Main application examples
- Model variations
- Type number nomenclature
- Standard specifications
- Common specifications**
- Terminal specifications
- Basic wiring diagram
- External dimensions
- Keypad
- Function codes
- Options
- Product warranty

Terminal Specifications

Class	Symbol	Terminal name	Explanation
Main circuit	L1/R,L2/S,L3/T	Main power supply input terminals	Connect a three-phase power supply.
	U,V,W	Inverter output	3-phase motor connection
	P(+),P1	For DC reactor connection	Connect a DC reactor (DCR) (option) for power-factor improvement.
	P(+),N(-)	For DC busbar connection	Use to connect to the DC intermediate circuit of other inverters, PWM converters, etc
	P(+),DB	For braking resistor connection	Connect terminal (+) of the braking resistor (DB) (optional) and the DB (wiring distance: 5 m or less)
	⊕G	For grounding the chassis (case) of the inverter	<ul style="list-style-type: none"> This is the earth terminal of the inverter chassis (case) and motor. Connect one terminal to the ground and the other terminal to the earth terminal of the motor (comes with two terminals).
	R0,T0	Auxiliary control power input	Connect to the power supply when you want to preserve the batch alarm signal during protective function activation (even when the main power of the inverter has been cut off), or when you want to continuously display the keypad (1.5 kW or higher Type: 0008 to 0432 (200 V) Type: 0004 to 1480 (400 V)).
Analog input	[13]	Power supply for variable resistor	<ul style="list-style-type: none"> Use as a power supply (+10 V DC) for an external frequency setter (variable resistor: 1 to 5 kΩ). Use a variable resistor of 1/2 W or more when connecting.
	[12]	Analog setting voltage input	<ol style="list-style-type: none"> Set the frequency according to the external analog voltage input instruction value. <ul style="list-style-type: none"> 0 to ±10 V DC/0 to ±100 (%) (normal action) +10 to 0 V DC/0 to 100 (%) (reverse action) It supports using analog inputs to assign to frequency settings, PID instructions, PID control feedback signals, auxiliary frequency settings, ratio settings, torque limiting settings, torque instruction values/torque current instruction values, speed limiting values, analog input monitors and other items. Hardware specification <ul style="list-style-type: none"> Input impedance: 22 (kΩ) Can input up to ±15 V DC. However, it will be deemed to be ±10 V DC for any value that exceeds ±10 V DC. Set function code C35 to "0" when inputting the analog setting voltage of both poles (0 to ±10 V DC) at terminal [12].
	[C1]	Analog setting current input (C1 function)	<ol style="list-style-type: none"> Set the frequency according to the external analog current input instruction value. <ul style="list-style-type: none"> 4 to 20 mA DC/0 to 100 (%) , 0 to 20 mA DC/0 to 100 (%) (normal action) 20 to 4 mA DC/0 to 100 (%) , 20 to 0 mA DC/0 to 100 (%) (reverse action) It supports using analog inputs to assign to frequency settings, PID instructions, PID control feedback signals, auxiliary frequency settings, ratio settings, torque limiting settings, torque instruction values/torque current instruction values, speed limiting values, analog input monitors and other items. Hardware specifications <ul style="list-style-type: none"> Input impedance: 250 (Ω) Can input up to 30 mA DC. However, it will be deemed to be 20 mA DC for any value that exceeds 20 mA DC.
		Analog setting voltage input (V3 function)	<ol style="list-style-type: none"> Set the frequency according to the external analog voltage input instruction value. <ul style="list-style-type: none"> 0 to ±10 V DC/0 to ±100 (%) (normal action) +10 to 0 V DC/0 to 100 (%) (reverse action) It supports using analog inputs to assign to frequency settings, PID instructions, PID control feedback signals, auxiliary frequency settings, ratio settings, torque limiting settings, torque instruction values/torque current instruction values, speed limiting values, analog input monitors and other items. Hardware specifications <ul style="list-style-type: none"> Input impedance: 22 (kΩ) Can input up to ±15 V DC. However, it will be deemed to be ±10 V DC for any value that exceeds ±10 V DC. Set function code C78 to "0" when inputting the analog setting voltage of both poles (0 to ±10 V DC) at terminal [V3].
		Analog setting voltage input (V2 function)	<ol style="list-style-type: none"> Set the frequency according to the external analog voltage input instruction value. <ul style="list-style-type: none"> 0 to ±10 V DC/0 to ±100 (%) (normal action) +10 to 0 V DC/0 to 100 (%) (reverse action) It supports using analog inputs to assign to frequency settings, PID instructions, PID control feedback signals, auxiliary frequency settings, ratio settings, torque limiting settings, torque instruction values/torque current instruction values, speed limiting values, analog input monitors and other items. Hardware specifications <ul style="list-style-type: none"> Input impedance: 22 (kΩ) Can input up to ±15 V DC. However, it will be deemed to be ±10 V DC for any value that exceeds ±10 V DC. Set function code C45 to "0" when inputting the analog setting voltage of both poles (0 to ±10 V DC) at terminal [V2].
	[V2]	PTC/NTC thermistor input (PTC/NTC function)	<ol style="list-style-type: none"> A PTC/NTC thermistor can be connected to protect the motor. The PCB's SW5 switch needs to be switched to PTC/NTC side. <ul style="list-style-type: none"> The figure below shows the internal circuit when SW5 (the switch for terminal [V2]) is switched to the PTC/NTC side. When SW5 is switched to PTC/NTC side, function code H26 also needs to be changed.
	[11]	Analog common	<ul style="list-style-type: none"> Common terminals for analog I/O signals (terminals [13], [12], [C1], [V2], [FM1], and [FM2]). Insulated against terminals [CM] and [CMY].

* For details, refer to the FRENIC-MEGA (G2) User's Manual.

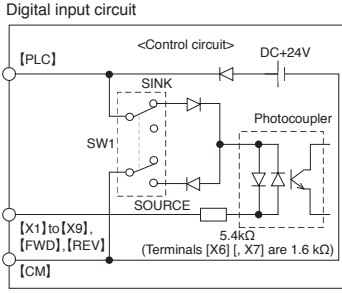
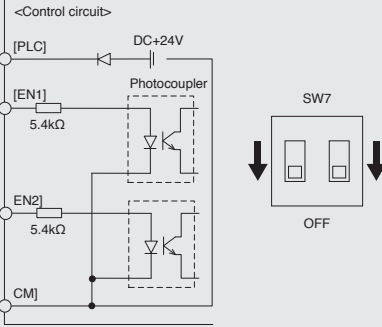
Class	Symbol	Terminal name	Explanation																										
Analog input	[X1]	Digital input 1	<p>(1) Various signals (coast to stop command, external alarms, multistep frequency selection, etc.) can be set for terminals [X1] to [X9], [FWD], and [REV].</p> <p>(2) The input mode and SINK/SOURCE can be switched using SW1.</p> <p>(3) The operating mode between each digital input terminal and terminal [CM] can be switched to "ON when shorted (active ON)" or "OFF when shorted (active OFF)".</p> <p>(4) Digital input terminals [X6] and [X7] can be set up as pulse train input terminals by changing the function code.</p> <ul style="list-style-type: none"> When connected to complementary output pulse generator: max. 100 Hz When connected to open collector output pulse generator: max. 30 Hz <p>(A pull-up resistor and pull-down resistor are required.)</p> <p><Digital input circuit specifications></p> <p>Digital input circuit</p>  <table border="1" data-bbox="965 593 1340 851"> <thead> <tr> <th>Item</th> <th></th> <th>Min.</th> <th>Max.</th> </tr> </thead> <tbody> <tr> <td rowspan="2">Operating voltage (SOURCE)</td> <td>ON level</td> <td>0V</td> <td>2V</td> </tr> <tr> <td>OFF level</td> <td>20V</td> <td>27V</td> </tr> <tr> <td rowspan="2">Operating voltage (SINK)</td> <td>ON level</td> <td>20V</td> <td>27V</td> </tr> <tr> <td>OFF level</td> <td>0V</td> <td>2V</td> </tr> <tr> <td colspan="2">Operating current when ON (when input voltage 27 V) (X6/X7 input terminals)</td> <td>2.5mA (3mA)</td> <td>5mA (16mA)</td> </tr> <tr> <td colspan="2">Permissible leakage current when OFF</td> <td>—</td> <td>0.5mA</td> </tr> </tbody> </table>	Item		Min.	Max.	Operating voltage (SOURCE)	ON level	0V	2V	OFF level	20V	27V	Operating voltage (SINK)	ON level	20V	27V	OFF level	0V	2V	Operating current when ON (when input voltage 27 V) (X6/X7 input terminals)		2.5mA (3mA)	5mA (16mA)	Permissible leakage current when OFF		—	0.5mA
	Item			Min.	Max.																								
	Operating voltage (SOURCE)	ON level		0V	2V																								
		OFF level		20V	27V																								
	Operating voltage (SINK)	ON level		20V	27V																								
		OFF level		0V	2V																								
	Operating current when ON (when input voltage 27 V) (X6/X7 input terminals)			2.5mA (3mA)	5mA (16mA)																								
	Permissible leakage current when OFF			—	0.5mA																								
	[X2]	Digital input 2																											
	[X3]	Digital input 3																											
[X4]	Digital input 4																												
[X5]	Digital input 5																												
[X6]	Digital input 6																												
[X7]	Digital input 7																												
[X8]	Digital input 8																												
[X9]	Digital input 9																												
[FWD]	Forward-rotation/stop command Input																												
[REV]	Reverse-rotation/stop command Input																												
[EN1] [EN2]	Enable input	<p>(1) When the terminal between [EN1] and [-PLC] or between [EN2] and [-PLC] is OFF, the operation of the inverter's output transistor will be stopped (Safe torque off: STO). Always make sure to operate terminals [EN1] and [EN2] simultaneously. If the terminals are not operated simultaneously, the eCf alarm will trigger and this will prevent the inverter from operating.</p> <p>(2) The input mode of terminals [EN1] and [EN2] is fixed to the source and cannot be switched to the sink.</p> <p>(3) SW7 can be used to enable or disable this function. To use this function, set each SW7 switch to OFF.</p> <p><Enabling input circuit specifications></p>  <table border="1" data-bbox="965 1153 1340 1332"> <thead> <tr> <th>Item</th> <th></th> <th>Min.</th> <th>Max.</th> </tr> </thead> <tbody> <tr> <td rowspan="2">Operating voltage (SOURCE)</td> <td>ON level</td> <td>20V</td> <td>27V</td> </tr> <tr> <td>OFF level</td> <td>0V</td> <td>2V</td> </tr> <tr> <td colspan="2">Operating current when ON (when input voltage 27 V)</td> <td>2.5mA</td> <td>10mA</td> </tr> <tr> <td colspan="2">Permissible leakage current when OFF</td> <td>—</td> <td>0.5mA</td> </tr> </tbody> </table>	Item		Min.	Max.	Operating voltage (SOURCE)	ON level	20V	27V	OFF level	0V	2V	Operating current when ON (when input voltage 27 V)		2.5mA	10mA	Permissible leakage current when OFF		—	0.5mA								
Item		Min.	Max.																										
Operating voltage (SOURCE)	ON level	20V	27V																										
	OFF level	0V	2V																										
Operating current when ON (when input voltage 27 V)		2.5mA	10mA																										
Permissible leakage current when OFF		—	0.5mA																										
[PLC]	Programmable controller signal power supply	<p>(1) Connect the output signal power supply for the programmable controller. (Rated voltage +24 VDC (power supply voltage fluctuation range: +20.4 to +27 VDC), maximum 100 mA DC)</p> <p>(2) The terminal can also be used as the power supply for loads connected to transistor outputs</p>																											
[CM]	Digital common	This is a common terminal for digital input signals. The terminal is insulated from terminals [11] and [CMY].																											
Analog output	[FM1] [FM2]	Analog monitor (FMA function)	<p>This function outputs a monitor signal of analog DC voltage 0 to ±10 V DC, analog DC current 4 to 20 mA DC, or 0 to 20 mA DC. The [FM1] output format (VO1/IO1) is switched by the PCB's SW4 switch and function code F29. The content of the signal is selected from the following items based on the data setting of function code F31. The [FM2] output format (VO2/IO2) is switched by the PCB's SW6 switch and function code F32. The content of the signal is selected from the following items based on the data setting of function code F61.</p> <table border="1" data-bbox="550 1713 1396 1836"> <thead> <tr> <th></th> <th>Power consumption</th> <th>Motor output</th> </tr> </thead> <tbody> <tr> <td>Output frequency</td> <td>PID feedback amount</td> <td>Analog output test</td> </tr> <tr> <td>Output current</td> <td>Speed detection (PG feedback value)</td> <td>PID command</td> </tr> <tr> <td>Output voltage</td> <td>Intermediate DC voltage</td> <td>PID output</td> </tr> <tr> <td>Output torque</td> <td>Universal AO</td> <td>Master-follower angle deviation and other items.</td> </tr> <tr> <td>Load factor</td> <td></td> <td></td> </tr> </tbody> </table> <p>* Connectable impedance: Minimum of 5 kΩ (when outputting 0 to ±10 V DC) (up to two analog voltmeters (0 to 10 V DC, input impedance of 10 kΩ) can be connected). * Connectable impedance: Maximum of 500 Ω (at 4 m to 20 mA DC output) * Gain adjustment range: 0 to 300%</p>		Power consumption	Motor output	Output frequency	PID feedback amount	Analog output test	Output current	Speed detection (PG feedback value)	PID command	Output voltage	Intermediate DC voltage	PID output	Output torque	Universal AO	Master-follower angle deviation and other items.	Load factor										
		Power consumption	Motor output																										
Output frequency	PID feedback amount	Analog output test																											
Output current	Speed detection (PG feedback value)	PID command																											
Output voltage	Intermediate DC voltage	PID output																											
Output torque	Universal AO	Master-follower angle deviation and other items.																											
Load factor																													
[11]	Analog common	This is a common terminal for analog input/output signals. This terminal is insulated from terminals [CM] and [CMY].																											

* For details, refer to the FRENIC-MEGA (G2) User's Manual.

Features
Main application examples
Model variations
Type number nomenclature
Standard specifications
Common specifications
Terminal specifications
Basic wiring diagram
External dimensions
Keypad
Function codes
Options
Product warranty

Terminal Specifications

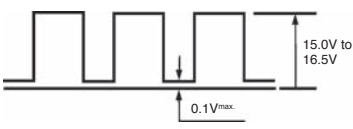
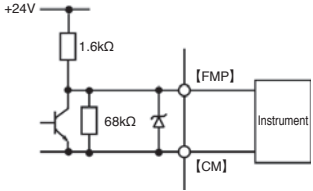
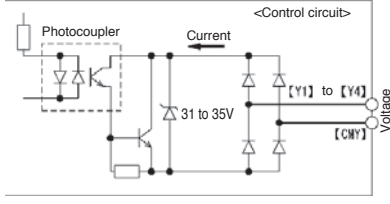
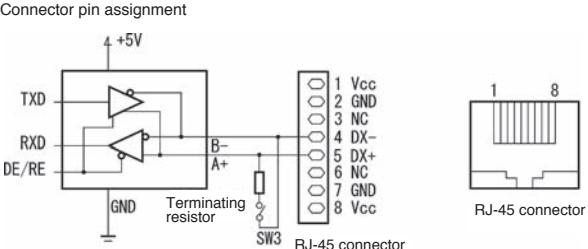
Class	Symbol	Terminal name	Explanation											
Analog output	[FMP]	Pulse monitor (FMP function)	<p>This function outputs pulse signals. The content of the signal can be selected in the same way as the FM1/2 function by setting the function code F35.</p> <p>* Connectable impedance: Minimum of 5 kΩ (up to two analog voltmeters (0 to 10 V DC, input impedance of 10 kΩ) can be connected.)</p> <p>* Pulse duty: About 50%; Pulse rate: 25 to 6000 p/s (at full scale)</p>											
			<p>Pulse output waveform</p>  <p>FMP output circuit</p> 											
	[CM]	Digital common	<p>This is a common terminal for digital input signals and terminal [FMP] output.</p> <p>The terminal is insulated from terminals [11] and [CMY]. This is the same terminal as terminal [CM] for digital input.</p>											
Transistor output	[Y1]	Transistor output 1	<p>(1) Various signals (running signals, frequency arrival signals, overload early warning signals, etc.) set with function codes E20 to E23 can be output.</p> <p>(2) The operating mode between transistor output terminals [Y1] and [Y4] and terminal [CMY] can be switched to "ON when signal output (active ON)" or "OFF when signal output (active OFF)".</p> <p><Transistor output circuit specifications></p> <p>Transistor output circuit</p>  <table border="1" data-bbox="997 884 1284 1030"> <thead> <tr> <th>Item</th> <th>Max.</th> </tr> </thead> <tbody> <tr> <td rowspan="2">Operating voltage</td> <td>ON level</td> <td>2V</td> </tr> <tr> <td>OFF level</td> <td>48V</td> </tr> <tr> <td>Operating current when ON</td> <td>50mA</td> </tr> <tr> <td>Leakage current when OFF</td> <td>0.1mA</td> </tr> </tbody> </table>	Item	Max.	Operating voltage	ON level	2V	OFF level	48V	Operating current when ON	50mA	Leakage current when OFF	0.1mA
	Item	Max.												
	Operating voltage	ON level		2V										
		OFF level		48V										
	Operating current when ON	50mA												
Leakage current when OFF	0.1mA													
[Y2]	Transistor output 2													
[Y3]	Transistor output 3													
[Y4]	Transistor output 4													
[CMY]	Transistor output common	<p>This is a common terminal for transistor output signals.</p> <p>This terminal is isolated from terminals [CM] and [11].</p>												
Analog output	[Y5A] [Y5C]	General-purpose relay output	<p>(1) The same signals as those of terminals [Y1] to [Y4] can be selected and output as multi-purpose relay outputs.</p> <p>Contact capacity: 250 VAC 0.3 A cosφ = 0.3, 48 VDC 0.5 A</p> <p>(2) It is possible to switch between a "short circuit between terminals [Y5A] and [Y5C] when an ON signal is output (excitation: active ON)" or an "open circuit between terminals [Y5A] and [Y5C] when an ON signal is output (non-excitation: active OFF)".</p>											
	[30A] [30B] [30C]	Integrated alarm output	<p>(1) When the inverter stops with an alarm, an integrated alarm is output at the relay contact (1C).</p> <p>Contact capacity: 250 VAC 0.3 A cosφ = 0.3, 48 VDC 0.5 A</p> <p>(2) The same signals as those of terminals [Y1] to [Y4] can be selected and output.</p> <p>(3) It is possible to switch between a "short circuit between terminals [30A] and [30C] when an ON signal is output (excitation: active ON)" or an "open circuit between terminals [30A] and [30C] when an ON signal is output (non-excitation: active OFF)".</p>											
	[DX+] [DX-] [SD]	RS-485 COM port 2 (terminal block)	<ul style="list-style-type: none"> This is an input/output terminal used to connect a personal computer or programmable controller, etc. by RS-485 communication. Use the recommended stick terminal when making a daisy chain connection. 											
Communication	RJ-45 connector Keypad	RS-485 COM port 1 (for keypad connection)	<p>(1) This is used as a connector for connecting the keypad. The keypad power is supplied from the inverter via an extension cable for remote operation.</p> <p>(2) This is used to connect a personal computer or programmable controller, etc. by RS-485 communication after disconnecting the keypad.</p> <p>Connector pin assignment</p>  <p>• Pins 1, 2, 7, and 8 are assigned as the keypad's power source.</p> <p>• Do not use these pins when connecting the RJ-45 connector to other devices.</p>											
	USB connector	USB port (on keypad)	<ul style="list-style-type: none"> This is a USB connector (mini B) for connecting to a personal computer. Use the inverter support loader (FRENIC loader) to edit, transfer, and verify function codes, perform test operations for the inverter, and monitor various statuses. 											

* For details, refer to the FRENIC-MEGA (G2) User's Manual.

Basic Wiring Diagram

Wiring of main circuit terminal and grounding terminal

Basic type

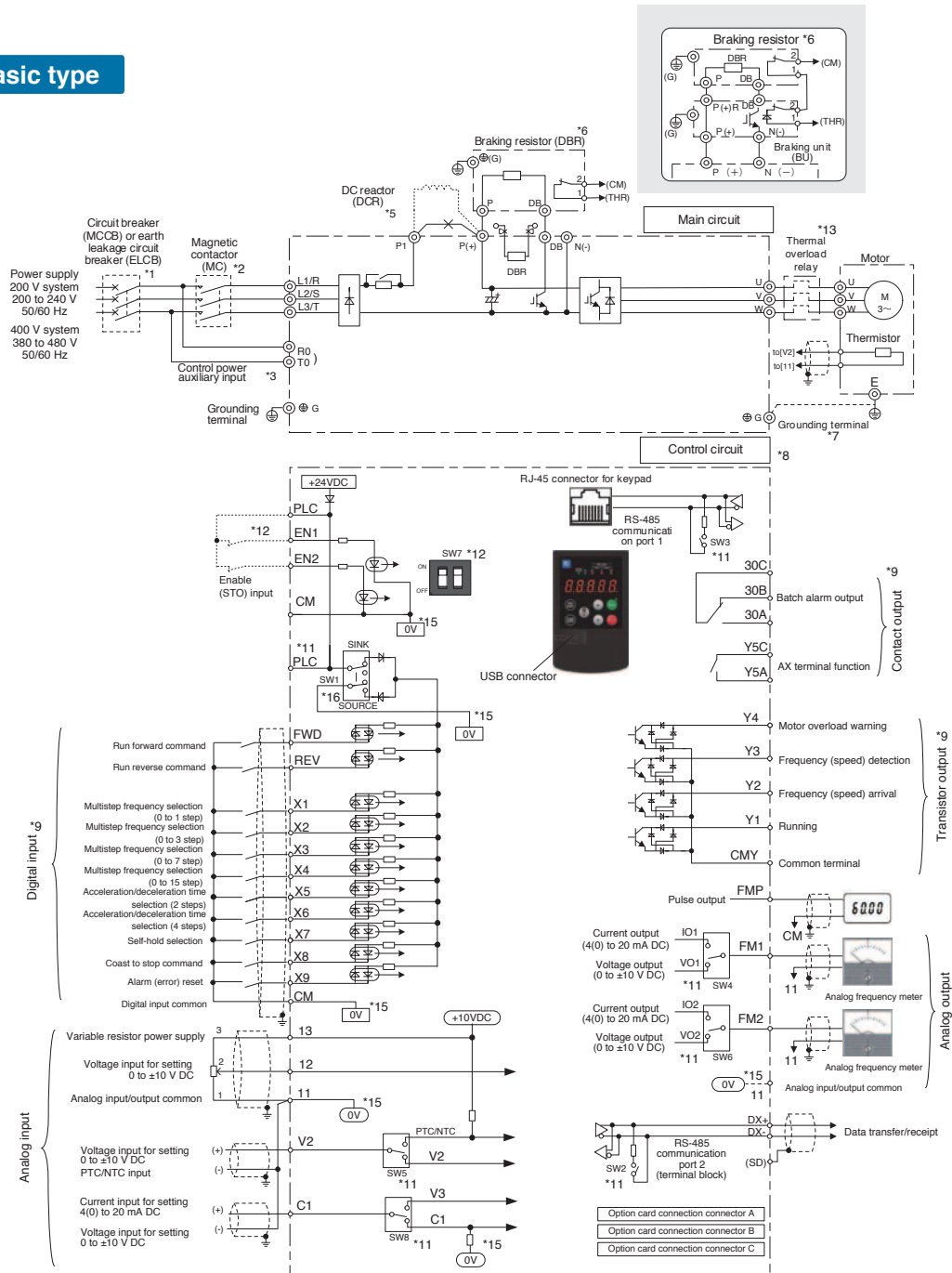

- *1 Install the molded case circuit breaker (MCCB) or earth leakage circuit breaker (ELCB) (with overcurrent protection function) recommended for each inverter on the inverter input side (primary side) to protect wiring. Do not use a circuit breaker that exceeds the recommended rated current.
- *2 An MCCB or ELCB is also used if isolating the inverter from the power supply, and therefore the magnetic contactor (MC) recommended for each inverter should be installed if required. Please note that if installing a coil such as an MC or solenoid near the inverter, connect a surge absorber in parallel.
- *3 If an warning or alarm signal issued if the protective function is triggered even when the inverter main power supply is cut off, or to constantly display the keypad, connect these terminals to the power supply. (on FRN0008G2□-2G or higher /FRN0008G2□-4G or higher)
The inverter can be run even without inputting the power supply to these terminals.
- *5 Remove the shorting bar between the inverter main circuit terminals P1 and P(+) before connecting the DC reactor (DCR) (option). Be sure to connect the DC reactor in the case of FRN0139G2□-4G ND / FRN0288G2□-2G HND / FRN0179G2□-4G HND, HD, ND specification and FRN0346G2□-2G or higher / FRN0217G2□-4G or higher inverters. Use a DC reactor (DCR) when the capacity of the power supply transformer is 500 kVA or more and is 10 times or more the inverter rated capacity, or when there are "thyristor-driven" loads.
- *6 FRN0288G2□-2G or lower / FRN0217G2□-4G or lower inverters are equipped with a built-in braking transistor, allowing direct connection of braking resistors between P(+) and DB.
If connecting a braking resistor (DB) (option) to FRN0346G2□-2G or higher / FRN0261G2□-4G or higher inverters, a braking unit (BU) (option) is necessary. A built-in braking resistor is connected between terminals P(+) and DB on FRN0046G2□-2G or lower /FRN0023G2□-4G or lower inverters. If connecting a braking resistor (DB), be sure to disconnect the built-in braking resistor.
- *7 This terminal is used for grounding the motor. Connect if required.
- *8 Use twisted wire or shielded wire for control signal lines.
Shielded wires are generally grounded, however, if subject to significant induction noise from outside, it may be possible to suppress the effect of the noise by connecting wires to [CM]. Isolate control signal lines from the main circuit wiring as best as possible, and do not run inside the same duct (a distance of 10 cm or greater is recommended.) If lines intersect, ensure that they do so almost perpendicularly to the main circuit wiring.
- *9 Each of the functions described for terminals [FWD] and [REV], terminals [X1] to [X9] (digital input), terminals [Y1] to [Y4] (transistor output), terminal [Y5A/C], and terminal [30A/B/C] (contact output) indicate functions assigned by factory default.
- *11 These are the switches on control PCBs, and are used to specify settings for inverter operation. Refer to the User's Manual, "2.2.7 Switching switches" for details.
- *12 Safety function terminals [EN1] and [EN2] are disabled with SW7 (2-pole switch) on the control PCB by factory default. If using this terminal function, be sure to change the respective SW7 switches to the OFF position and connect.
- *13 The thermal overload relay is applicable as necessary. Make the circuit breakers (MCCB) or the magnetic contactors (MC) trip by the thermal relay auxiliary contacts (manual recovery).
- *15 \overline{OV} and OV are separated and insulated.
- *16 The factory default setting for SW1 of FRN-G2E-4G is "SOURCE".

Features
Main application examples
Model variations
Type number nomenclature
Standard specifications
Common specifications
Terminal specifications
Basic wiring diagram
External dimensions
Keypad
Function codes
Options
Product warranty

External Dimensions

Basic type

EMC Filter Built-in Type

Type FRN0003G2□-2G, FRN0002G2□-4G

[Unit: mm (inch)]

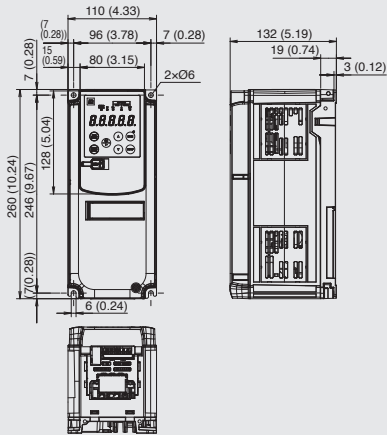

Type FRN0005G2□-2G, FRN0003G2□-4G

[Unit: mm (inch)]

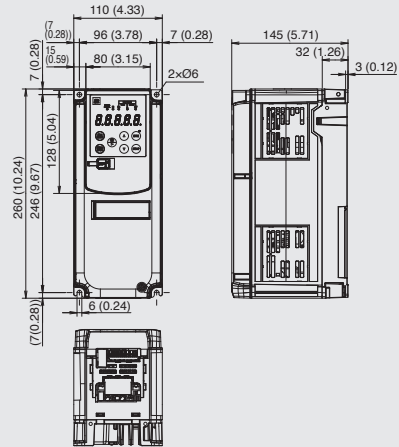

Type FRN0008G2□-2G to FRN0018G2□-2G, FRN0004G2□-4G to FRN0009G2□-4G

[Unit: mm (inch)]

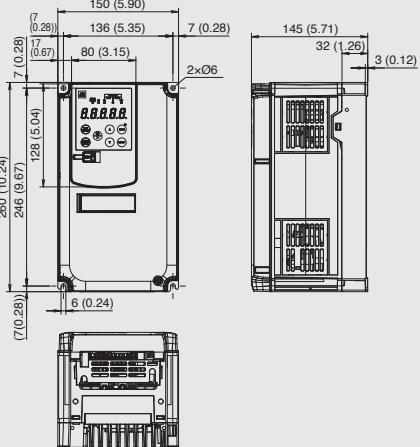

Type FRN0032G2□-2G to FRN0059G2□-2G, FRN0018G2□-4G to FRN0035G2□-4G

[Unit: mm (inch)]

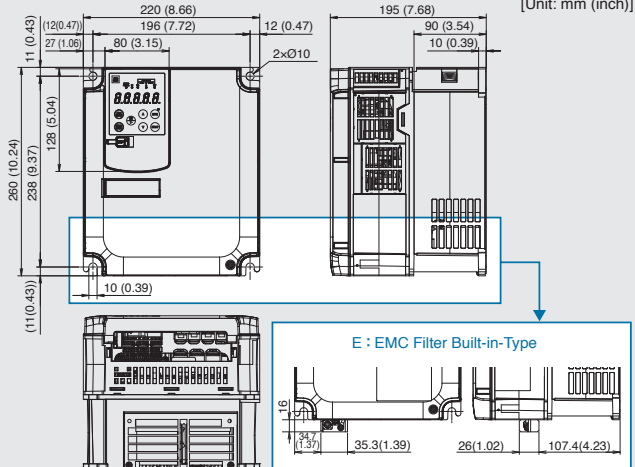

Type FRN0075G2□-2G to FRN0115G2□-2G, FRN0041G2□-4G to FRN0060G2□-4G

[Unit: mm (inch)]

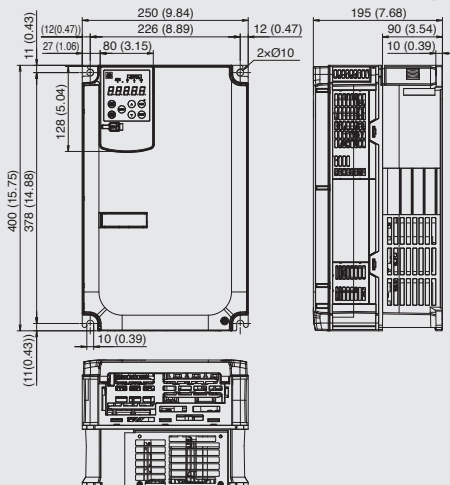

Basic type

EMC Filter Built-in Type

Type **FRN0146G2□-2G, FRN0085G2□-4G, FRN0105G2□-4G**

[Unit: mm (inch)]

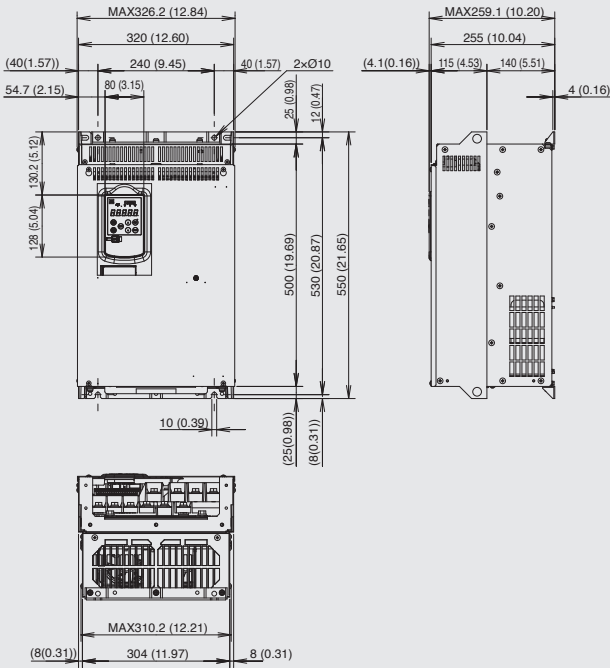

Type **FRN0180G2□-2G, FRN0139G2□-4G**

[Unit: mm (inch)]

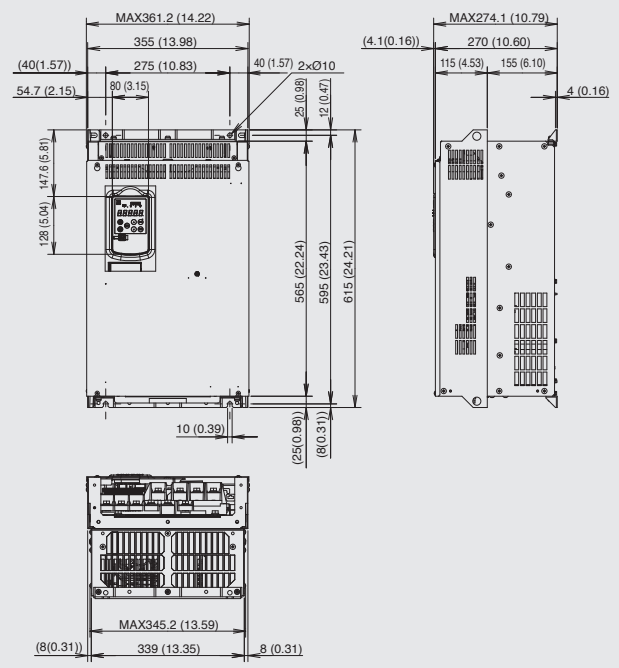

Type **FRN0179G2□-4G**

[Unit: mm (inch)]

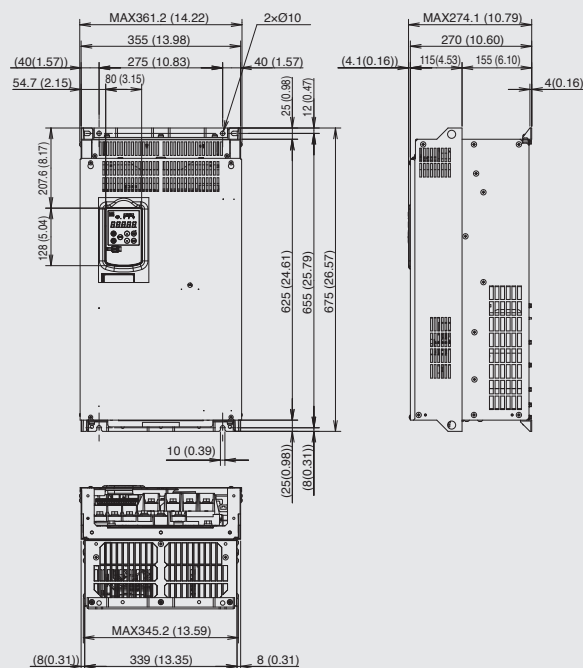

Type **FRN0215G2□-2G, FRN0288G2□-2G, FRN0217G2□-4G**

[Unit: mm (inch)]

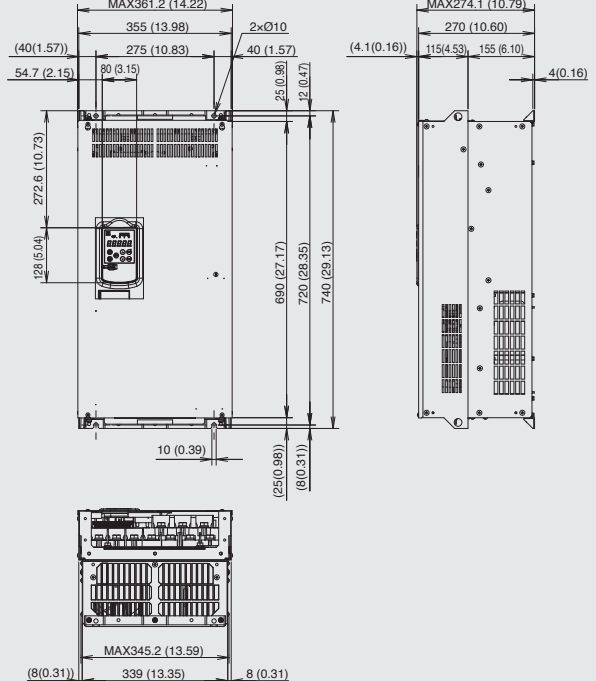

Features

Main application examples

Model variations

Type number nomenclature

Standard specifications

Common specifications

Terminal specifications

Basic wiring diagram

External dimensions

Keypad

Function codes

Options

Product warranty

External Dimensions

Basic type

EMC Filter Built-in Type

Type FRN0346G2□-2G

[Unit: mm (inch)]

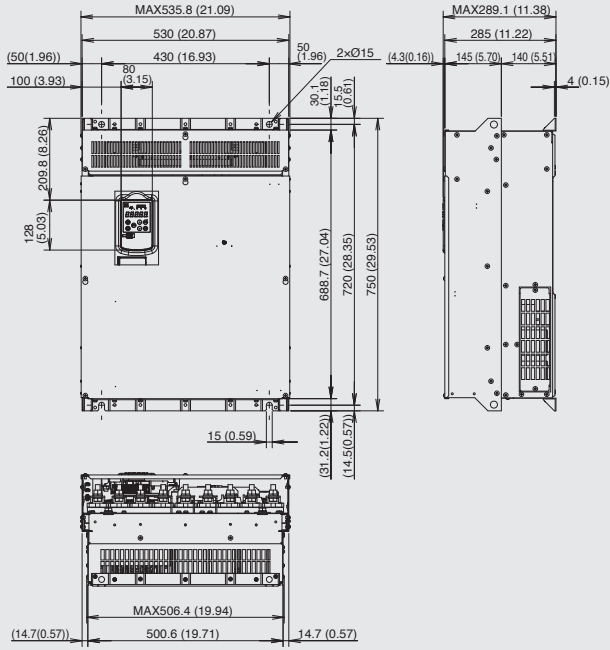

Type FRN0432G2□-2G

[Unit: mm (inch)]

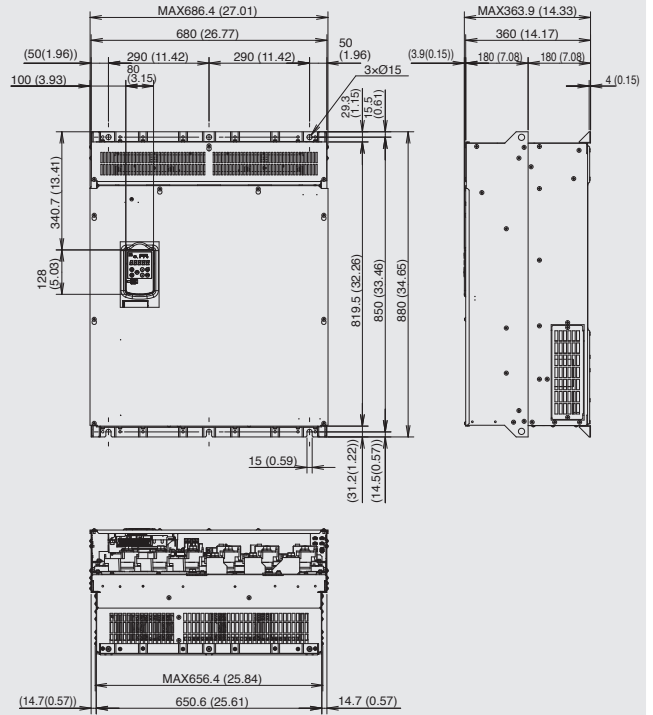

Type FRN0261G2□-4G, FRN0290G2□-4G

[Unit: mm (inch)]

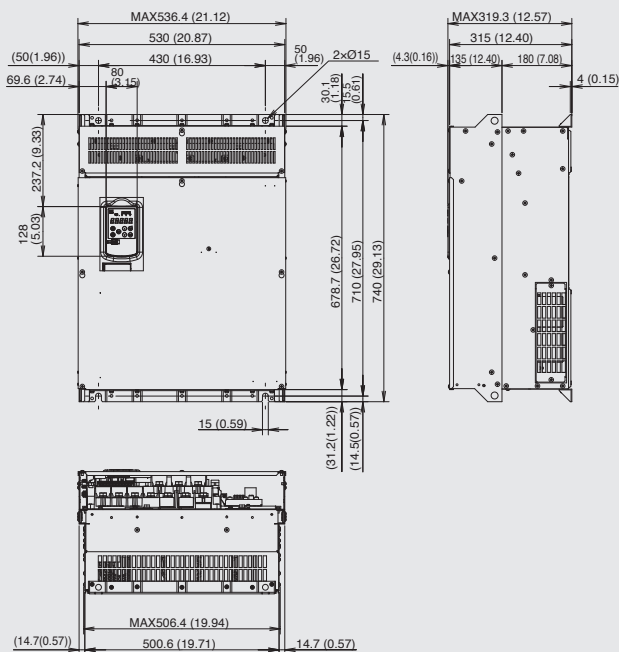

Type FRN0376G2□-4G, FRN0431G2□-4G

[Unit: mm (inch)]

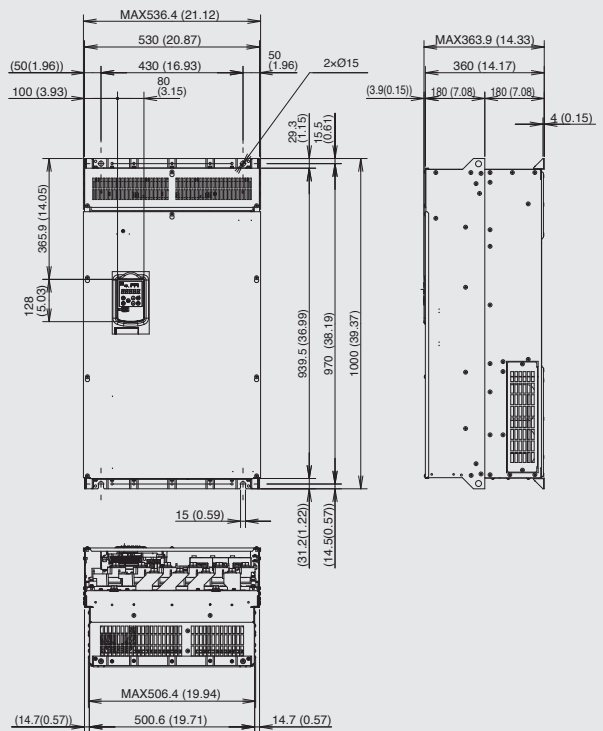

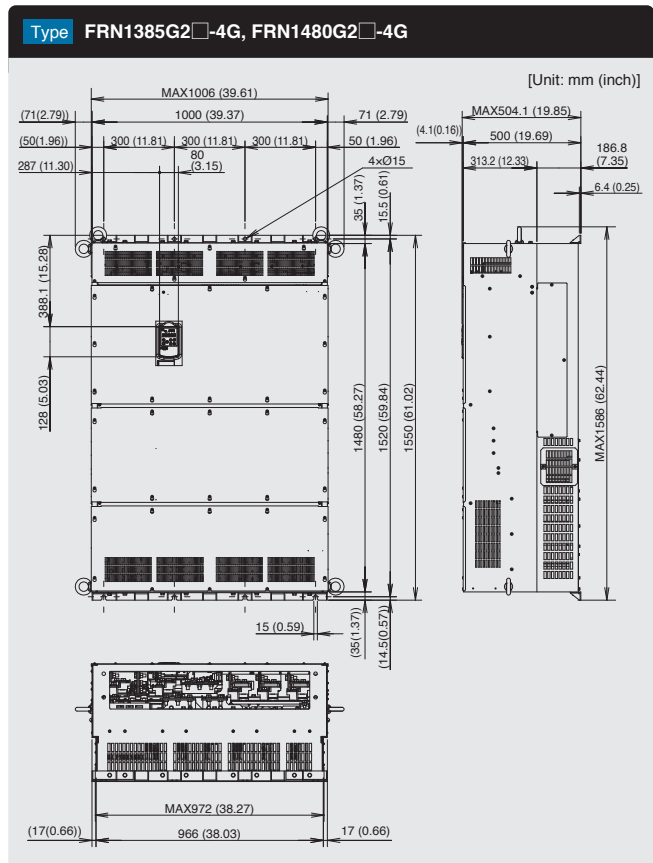
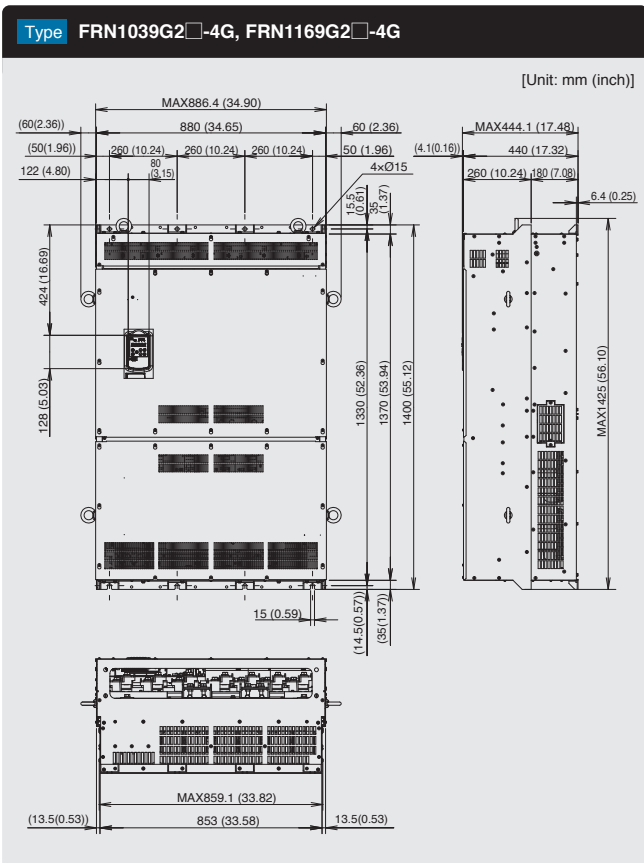
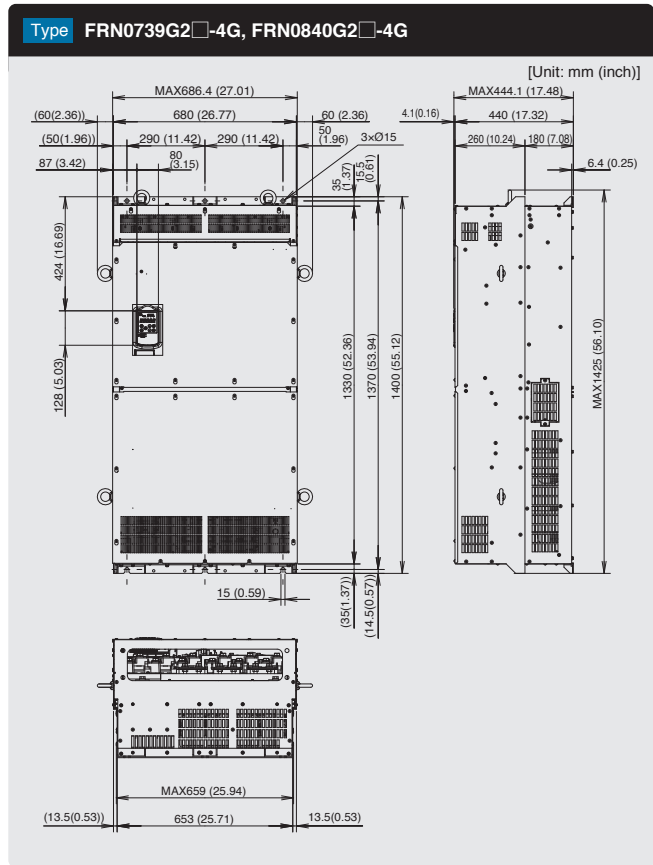
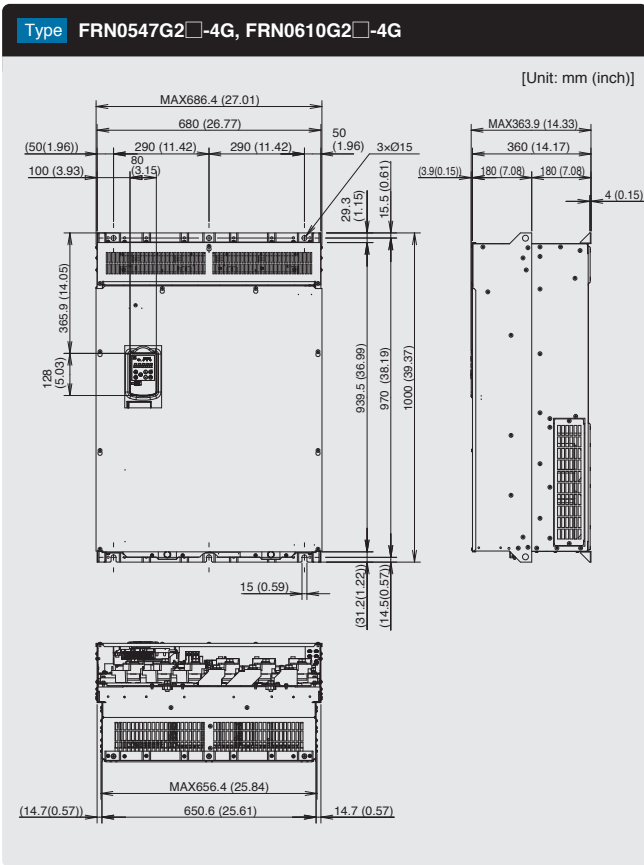

External Dimensions

Keypad

Standard (USB connector model) Type : TP-E2 Option

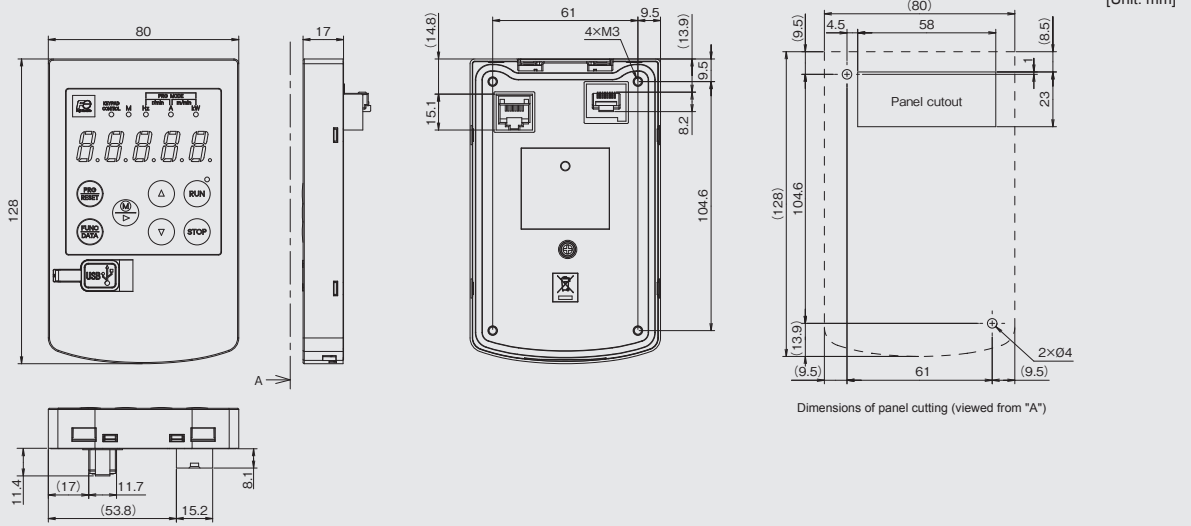

Multi-functional (USB connector model) Type : TP-A2SW Option

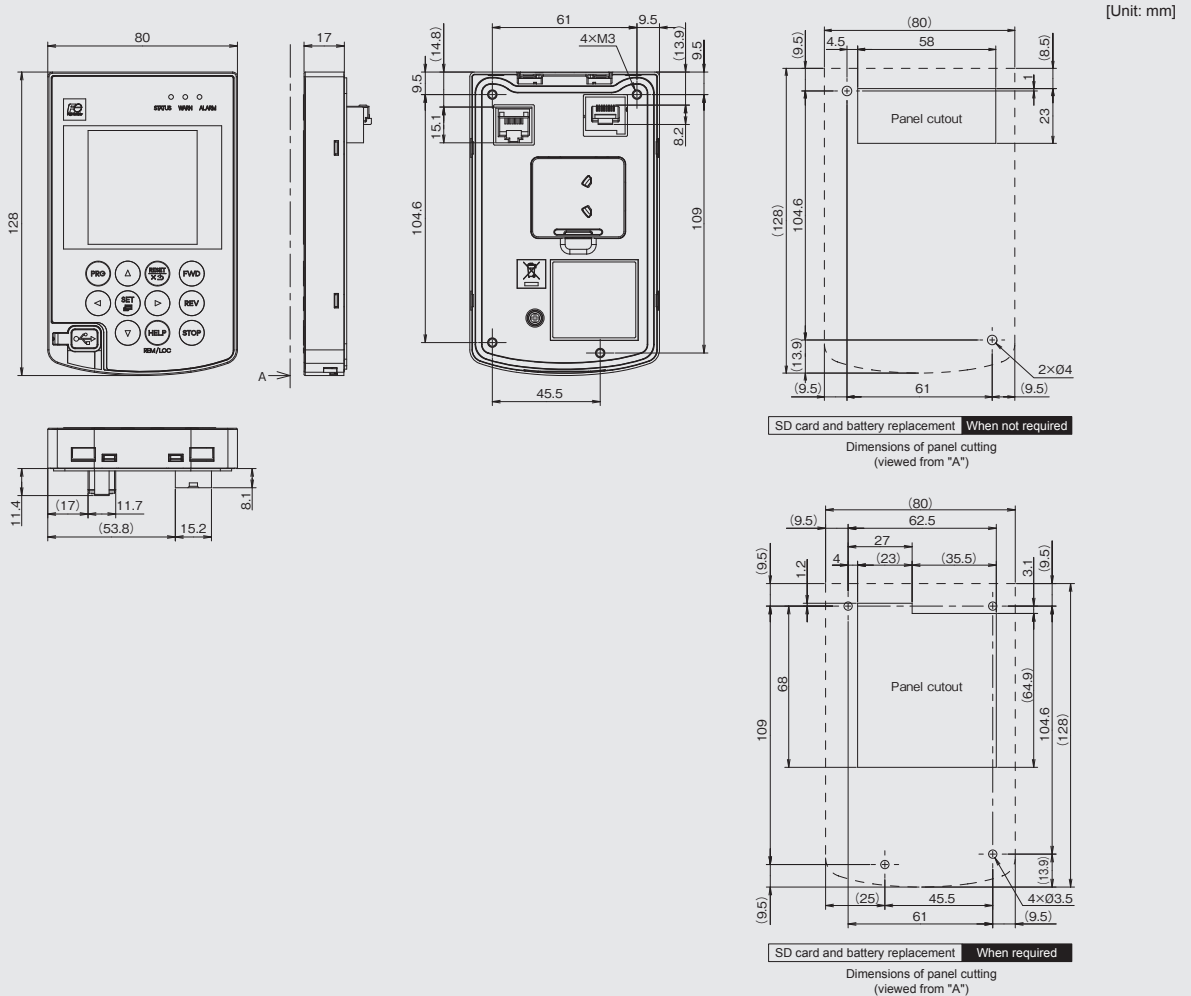

Keypad Functions

Use the keypad to start and stop the inverter, display various data, set function code data, check I/O, and display maintenance and alarm information.

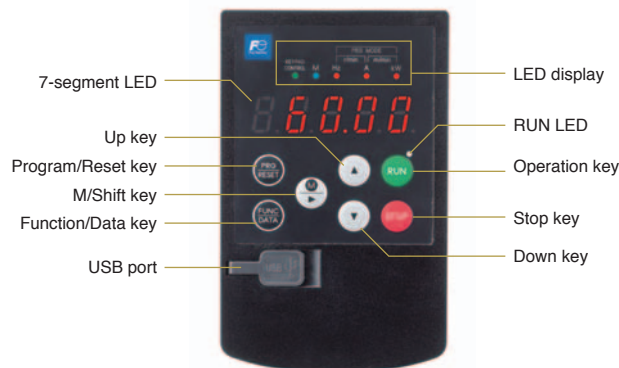

Overview of operation and functionality

Item	Display and keys	Overview of functionality
Data display		<p>This is a 5-digit, 7-segment LED monitor. It displays the following information for each operation mode.</p> <ul style="list-style-type: none"> ■ Operation mode : Operation information (output frequency, output current, output voltage, etc.) Switches to status display when the operating state is other than normal. Switches to minor failure display when a minor failure occurs. ■ Program mode : Menu, function code, function code data, etc. ■ Alarm mode : Alarm code indicating the cause of the protection function's activation.
Key operation		<p>Switches the operation mode.</p> <ul style="list-style-type: none"> ■ Operation mode : Pressing this key will switch it to program mode. ■ Program mode : Pressing this key will switch it to operation mode. ■ Alarm mode : After clearing the alarm cause, pressing this key will switch it to the operation mode deactivated by the alarm.
		<p>Performs the following operations:</p> <ul style="list-style-type: none"> ■ Operation mode : Switches the operation state monitoring items (output frequency, output current, output voltage, etc.). ■ Program mode : Displays function code or establishes the data. ■ Alarm mode : Switches the display of the alarm detailed information.
		Starts the motor operation. (When the keypad is being operated)
		Stops the motor operation. (When the keypad is being operated)
		Used to select the setting items displayed on the LED monitor or change the function code data.
LED display		<ul style="list-style-type: none"> ■ Operation mode : The functionality assigned by function code E70 is available. Press and hold for one second to turn the functionality ON or OFF. It is OFF by default when the power is turned on. ■ Program mode <ul style="list-style-type: none"> During menu display : Proceeds to the next menu number. During function code display : Advances the display number in steps of 10. During numerical setting : Moves the cursor digit to the right. ■ Alarm mode : Advances the alarm detailed information number in steps of 10.
	RUN (Green)	Lights up when the "RUN" key is pressed or when operated by issuing the "FWD" or "REV" signal or communication commands.
	KEYPAD CONTROL (Green)	Lights up when the "RUN" key on the keypad is enabled as an operation command. However, in program mode or alarm mode, no operation is possible even if this LED is lit. It blinks every second in local mode.
	M (Blue)	Displays the selected signal with function code E71.
Unit LEDs (three red LEDs)		Hz, A, kW, r/min, m/min: Displays the unit when monitoring the operating status in operation mode via a combination of three LEDs.
		PRG.MODE: Two LEDs on the left and right will light up when you transition to program mode. (● Hz ○ A ● kW)
USB port		<p>The inverter can be connected to a computer via a USB cable. The inverter has a mini-B type connector.</p>

Keypad Operation

» LED monitor

In Running mode, the LED monitor displays running status information (output frequency, current or voltage); in Programming mode, it displays menus, function codes and their data; and in Alarm mode, it displays an alarm code which identifies the alarm factor that has activated the protective function.

If one of LED5 through LED1 is blinking, it means that the cursor is at this digit, allowing you to change it.

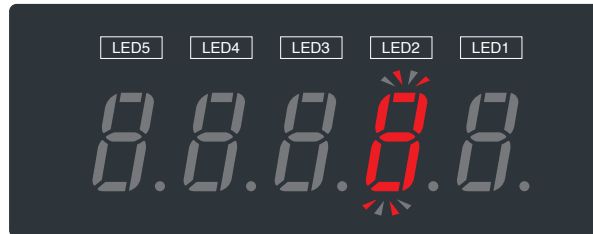

segment LED monitor (LED2 is blinking)

■ segment LED monitor display

Character	7-segment	Character	7-segment	Character	7-segment	Character	7-segment
0	0	9	9	I*	I or J	R	r
1	1	A	A	J	J	S	S
2	2	b	b	K	P	T*	t or t
3	3	C	C or c	L	L	U*	U or u
4	4	d	d	M	n	V*	U or u
5	5	E	E	N	n	W	W
6	6	F	F	O	0 or o	X	t
7	7	G	G or g	P	P	Y	y
8	8	H	H or h	Q	q	Z	z
Special characters and symbols (numbers with decimal point, minus and underscore)							
0. to 9.	0. to 9.	-	-	_	_	~	~
		[[]]	%	%
		:	:	;	;	^	^

*: Upper case and lower case characters are used based on the displayed content.

» Overview of Operation Modes

FRENIC-MEGA is equipped with the following three operation modes.

Operation mode	Description
Running Mode	<ul style="list-style-type: none"> When powered ON, the inverter automatically enters this mode. This mode allows you to specify the reference frequency, PID command value and etc., and run/stop the motor with the RUN / STOP keys. The running status can also be monitored in real time. Changes to the status display when not in the normal running status. Changes to the light alarm display when a light alarm occurs.
Programming Mode	This mode allows you to configure function code data and check a variety of information relating to the inverter status and maintenance.
Alarm Mode	<p>If an alarm condition arises, the inverter automatically enters Alarm mode in which you can view the corresponding alarm code* and its related information on the LED monitor.</p> <p>* Alarm code: Indicates the cause of the alarm condition.</p>

■ Status transition between operation modes

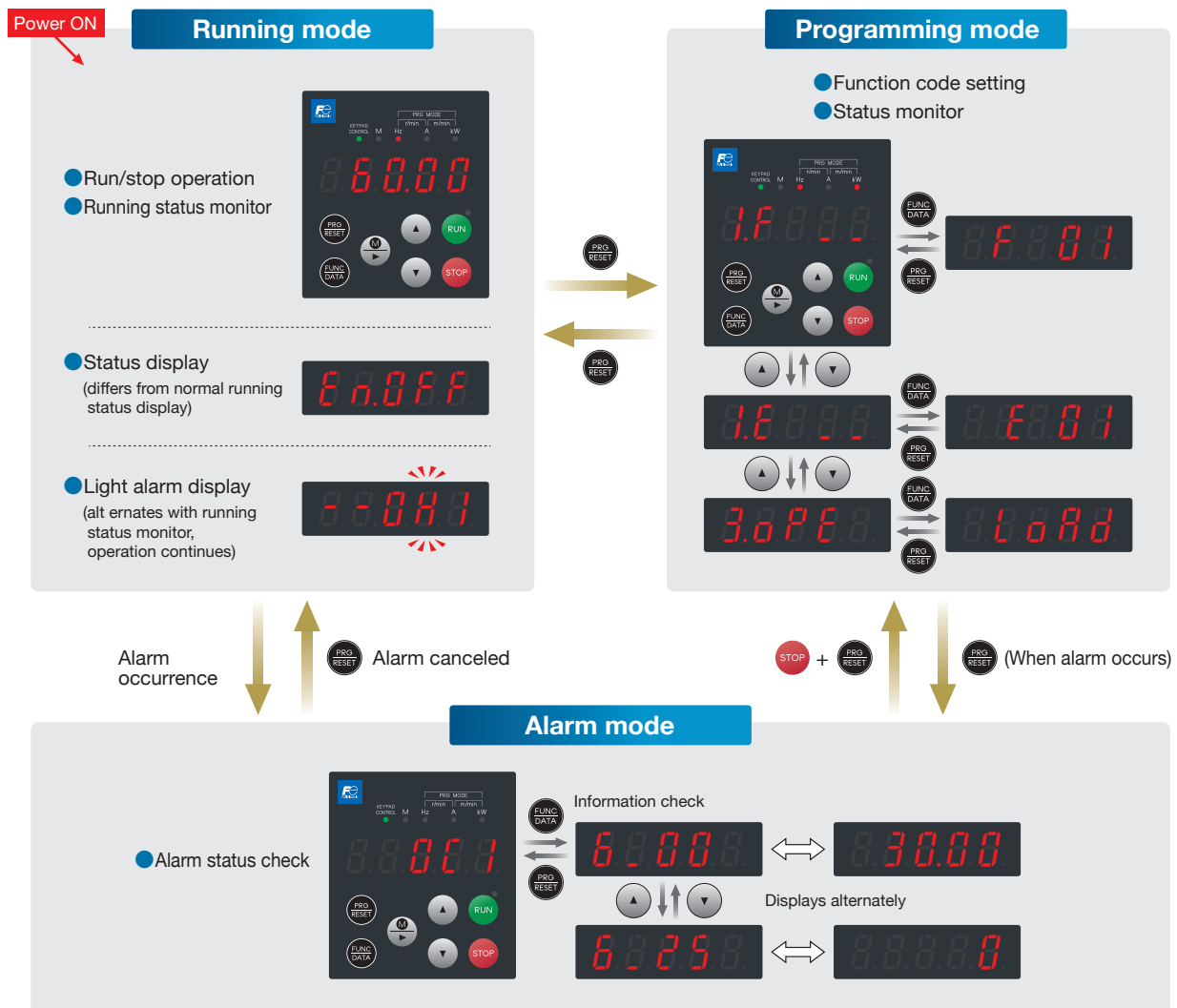

Tip

Simultaneous keying

Simultaneous keying means pressing two keys at the same time.

The simultaneous keying operation is expressed by a "+" letter between the keys throughout this manual.

For example, the expression "**STOP** + **PRG RESET** keys" stands for pressing the **STOP** key with the **PRG RESET** key held down.

Running Mode

Operating State Monitor

In running mode, the items in Table 3.3-1 below can be monitored. The monitor items set with function code E43 are displayed immediately after turning the power on. Press the  key to switch between monitor items.

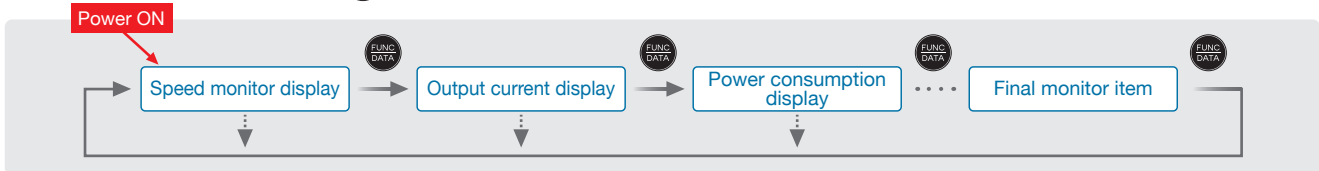

Tip By holding down the  key, the display returns to the speed monitor display.

Monitor items

●:ON ●:OFF

Monitor item	example	LED indication	Unit	Meaning of displayed value	Data for E43
Speed monitor	Function code E48 specifies what to be displayed on the LED monitor and LED indicators.				0
Output frequency 1 (before slip compensation)	50.00	●Hz ●A ●kW	Hz	Frequency actually being output	(E48=0)
Output frequency 2 (After slip compensation)	50.00	●Hz ●A ●kW	Hz	Frequency actually being output	(E48=1)
Frequency specified by frequency command when alarm occurred	50.00	●Hz ●A ●kW	Hz	Indicated value = Reference frequency (Hz)	(E48=2)
Motor speed	1500	●Hz ●A ●kW	min ⁻¹	Indicated value = Output frequency (Hz) × $\frac{120}{P01}$	(E48=3)
Load shaft speed	300.0	●Hz ●A ●kW	min ⁻¹	Indicated value = Output frequency (Hz) × Output frequency (Hz) × E50/E39	(E48=4)
Line speed	300.0	●Hz ●A ●kW	m/min	Indicated value = Output frequency (Hz) × Output frequency (Hz) × E50/E39	(E48=5)
Constant feeding rate time	50	●Hz ●A ●kW	min	Indicated value = $\frac{E50}{\text{Output frequency (Hz)} \times E39}$	(E48=6)
Speed (%)	50.0	●Hz ●A ●kW	%	Indicated value = $\frac{\text{Output frequency (Hz)}}{\text{Max. frequency}} \times 100$	(E48=7)
Line speed (after acceleration/deceleration)	1800.	●Hz ●A ●kW	m/min	Line speed setting value after calculating acceleration/deceleration with d168 and d169 for line speed set with E48 = 5	(E48=8)
Line speed (after winding diameter compensation)	1800.	●Hz ●A ●kW	m/min	Roll frequency setting value compensated with winding diameter calculation result for line speed set with E48 = 5	(E48=9)
Output current when alarm occurred.	12.34	●Hz ●A ●kW	A	Current output from the inverter in RMS	3
Power consumption	10.25	●Hz ●A ●kW	kW	Input power to the inverter	9
Calculated torque *1	50	●Hz ●A ●kW	%	Motor output torque in % (Calculated value)	8
Output voltage *2	200.0	●Hz ●A ●kW	V	Output voltage (RMS) of the inverter	4
Motor output *3	9.85	●Hz ●A ●kW	kW	Motor output (kW)	16
Load factor *4	50.	●Hz ●A ●kW	%	Load factor of the motor in % as the rated output being at 100%	15
PID output *5, *6	10.00.	●Hz ●A ●kW	-	PID command/feedback amount converted to a physical quantity of the object to be controlled (e.g. temperature)	10
PID feedback value*5,*7	9.00.	●Hz ●A ●kW	-	Refer to function codes J106 and J107 for details.	12
PID deviation*5, *7	1.00.	●Hz ●A ●kW	-	PID command value and PID feedback value deviation converted into physical quantities of the object to be controlled	29
PID output *5, *6	100.0.	●Hz ●A ●kW	%	Remaining time for timer operation	14
Timer *10	50	●Hz ●A ●kW	s	PID output in % as the maximum frequency (F03) being at 100%	13
Analog input monitor *8	82.00	●Hz ●A ●kW	-	An analog input to the inverter in a format suitable for a desired scale. Refer to the following function codes. Terminal [12]: C59, C60 Terminal [C1] (C1 function): C65, C66 Terminal [C1] (V3 function): C85, C86 Terminal [V2] : C71, C72	17
Command position*11	765 432.1	●Hz ●A ●kW	-	Alternate display of 4 higher order digits (with sign) and 4 lower order digits	21
Positioning deviation*11	765 432.1	●Hz ●A ●kW	-	Alternate display of 4 higher order digits (with sign) and 4 lower order digits	22
Position control start position*11	765 432.1	●Hz ●A ●kW	-	Alternate display of 4 higher order digits (with sign) and 4 lower order digits (with sign) for position when run command ON or when POS-SET enabled with user value	27
Stop target position*11	765 432.1	●Hz ●A ●kW	-	Alternate display of 4 higher order digits (with sign) and 4 lower order digits (with sign) for stop target position with user value	28
Torque current *9	48	●Hz ●A ●kW	%	Torque current command value or calculated torque current	23
Magnetic flux command *9	50	●Hz ●A ●kW	%	Magnetic flux command value	24
Input watt-hour	100.0	●Hz ●A ●kW	kWh	Indicated value = $\frac{\text{Input watt-hour (kWh)}}{100}$	25

*1 Calculated torque 100% is equal to the motor rated torque. For the calculation formula of the motor rated torque, refer to E.2 "Calculated formula" (1) in Appendix E "Conversion from SI Units."

*2 If displaying the output voltage, is displayed as the last digit on the LED monitor to denote the unit for V (volts). *3 When the LED monitor displays the motor output, the unit LED indicator "kW" blinks.

*4 When the LED monitor displays the load factor, the 7-segment letter in the lowest digit stands for "%". *5 These PID related items appear only under the PID control specified by function code J01 (= 1, 2 or 3).

*6 When the LED monitor displays a PID command or its output amount, the dot (decimal point) attached to the lowest digit of the 7-segment letter blinks.

*7 When the LED monitor displays a PID feedback amount, the dot (decimal point) attached to the lowest digit of the 7-segment letter blinks.

*8 The analog input monitor appears only when the analog input monitor function is assigned to one of the analog input terminals by one of function codes E61 to E63 (= 20). Specify the unit with C58, C64 and C70.

*9 Displays 0 (zero) under V/f control. *10 Displays (function code C21 = 3) only if performing timer operation. *11 Displays when the position control function is enabled.

Monitor items

●:ON ○:OFF

Monitor item	example	LED indication	Unit	Meaning of displayed value	Data for E43
Winding diameter*12	54321	●Hz ●A ●kW	mm	Winding diameter calculation result display for constant surface speed control	26
Torque bias	25	●Hz ●A ●kW	%	Torque bias value display	30
Estimated inertia acceleration/deceleration time conversion value*101	1.234	●Hz ●A ●kW	s	Display of estimated inertia result in logic acceleration/deceleration time	31
Customizable logic output*13	82.00	●Hz ●A ●kW	-	Display of output content for specific customizable logic step See function codes U98, U99.	32
PID command value (final) *5,*6	10.00	●Hz ●A ●kW	J105,	The finally selected PID command value and PID feedback value are converted into physical quantities of the object to be controlled.	50 *101
PID feedback value (final) *5,*7	9.00	●Hz ●A ●kW	J205		51 *101
PID output *5,*7	100.0	●Hz ●A ●kW	%	Displays PID output as a percentage, with the maximum output frequency being 100%.	52 *101
PID control 1 command value *5,*6	10.00	●Hz ●A ●kW	J105	The PID control 1 PID command value and PID feedback value are converted into physical quantities of the object to be controlled.	53 *101
PID control 1 feedback value *5,*7	9.00	●Hz ●A ●kW			54 *101
PID control 2 command value *5,*6	10.00	●Hz ●A ●kW	J205	The PID control 2 PID command value and PID feedback value are converted into physical quantities of the object to be controlled.	55 *101
PID control 2 feedback value *5,*7	9.00	●Hz ●A ●kW			56 *101
External PID control 1 command value (final) *5,*6	10.00	●Hz ●A ●kW	J505,	The finally selected external PID command value and external PID feedback value are converted into physical quantities of the object to be controlled. See function codes J506, J507.	60 *101
External PID control 1 feedback value (final) *5,*7	9.00	●Hz ●A ●kW	J605		61 *101
External PID control 1 output *5,*6	100.0	●Hz ●A ●kW	%	Displays external PID1 output as a percentage. (analog output, digital output possible) See function codes F31, J617.	62 *101
External PID control 1 manual command value *5,*6	100.0	●Hz ●A ●kW	%	Displays external PID1 manual command values as a percentage.	63 *101

*5 Displayed only if performing PID control.

*6 When the LED monitor displays a PID command or its output amount, the dot (decimal point) attached to the lowest digit of the 7-segment letter blinks.

*7 When the LED monitor displays a PID feedback amount, the dot (decimal point) attached to the lowest digit of the 7-segment letter lights.

*9 Displays 0 (zero) under V/f control.

*11 Displays when the position control function is enabled.

*12 Displays only if constant surface speed control is enabled with d41 = 1.

*13 Displays only if U00 = 1 and U98 0.

*101 Compatible with software version ROM0500 or later.



Tip

The monitoring signals for the monitor items such as keypad output frequency and output current can be filtered with function code E42 (LED display filter). If the display varies unstably so as to be hard to read due to load fluctuation or other causes, increase this filter time constant. (Function code E42)

Programming Mode

The Programming mode provides you with the following functions--setting and checking function code data, monitoring maintenance information and checking input/output (I/O) signal status. The functions can be easily selected with the menu-driven system. Table 3.4-1 below lists menus available in Programming mode. The leftmost digit (numerals) of each letter string on the LED monitor indicates the corresponding menu number and the remaining digits indicate the menu contents.

When the inverter enters Programming mode from the second time on, the menu selected last in Programming mode will be displayed.

Menus available in programming mode

Menu #	Menu	LED monitor indication	Main function
1	"Data Setting"	1.F ..	F codes (Basic functions)
		1.E ..	E codes (Extension terminal functions)
		1.C ..	C codes (Control functions)
		~ (Omitted) ~	
		1.o ..	o codes (optional functions)
2	"Data Checking"	2.rEP	Displays only function codes that have been changed from their factory defaults. The function code data can be referenced and changed.
3	Run monitor	3.oPE	Displays the running information required for maintenance or test runs.
4	I/O check	4.i_o	Displays external interface information.
5	"Maintenance Information"	5.cHE	Displays maintenance information including cumulative run time.
6	Alarm Information	6.aL	Alarm codes for the past four alarms can be displayed, and operating information at the time each alarm occurred can be referenced.
7	Data copy	7.cPY	Function code data can be read, written, and verified.
8	Destination setting	8.dESt	Sets the region (overseas) in which the product is used. This is not used for machines for use in Japan.
9	Communication monitor	9.sAddr 9.dAtA	Codes communicated back and forth between the host device can be monitored, and communication commands can be entered. Refer to the "FRENIC-MEGA (G2) User's Manual" for details.
0	Favorites	0.FnL	Only function codes selected by users can be referenced or changed.



Tip

Enter Programming mode at the keypad to display the menu. Change the menu with the ▲ and ▼ keys, and select the desired menu item with the key. Once the entire menu has been cycled through, the display returns to the first menu item. Press the key to proceed to the next menu number.

Programming Mode

Reading alarm information Alarm Information 6.AL

Menu number 6 “Alarm Information: 6.AL” shows the causes of the past 10 alarms with an alarm code. Further, it is also possible to display alarm information that indicates the status of the inverter when the alarm occurred.

It can also display alarm information showing the status of the inverter during the last four alarms.

“Alarm Information” menu transition

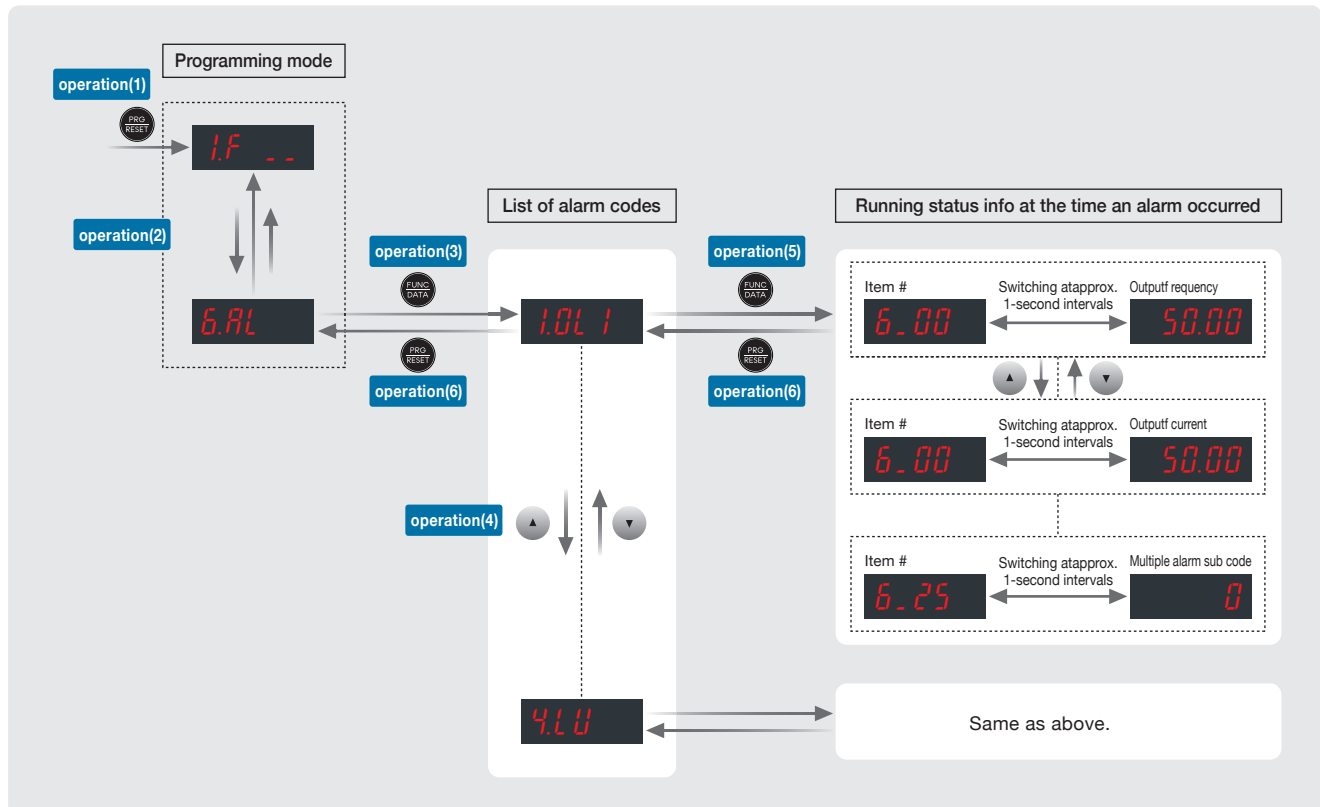

Basic key operation

- operation(1)** Turn the inverter ON. It automatically enters Running mode in which you press the key to switch to Programming mode. The function selection menu appears.

- operation(2)** Use the or key to display “Alarm Information” (6.AL). Press the key to skip in menu number units.

- operation(3)** Press the key to proceed to the list of alarm codes (e.g., 1.OL 1). In the list of alarm codes, the alarm information for the last 4 alarms is saved as an alarm history.

- operation(4)** Each time the or key is pressed, the last 4 alarms are displayed beginning with the most recent one in the order “1.”, “2.”, “3.”, “4.”. By pressing the key, the display returns to the latest alarm history.

- operation(5)** Press the key with an alarm code being displayed. The monitor number (e.g. 6.00) and the inverter status information (e.g. Output frequency) at the time of the alarm occurrence alternately appear at approx. 1-second intervals. Pressing the keys displays other monitor numbers (e.g., 6.01) and the status information (e.g., Output current) for that alarm code. By pressing the key at this time, the display can be switched between the monitor number and symbol.

- operation(6)** Press the key to return to the list of alarm codes. Press the key again to return to the menu.

“Alarm Information” display content

Monitor No.	Symbol	Displayed content	Description
6.00	<i>Fout1</i>	Output frequency	Output frequency before slip compensation when alarm occurred
6.01	<i>IOUt</i>	Output current when alarm occurred.	Output current when alarm occurred. Unit: A (amperes)
6.02	<i>Uout</i>	Output voltage when alarm occurred	Output voltage when alarm occurred Unit: V (volts)
6.03	<i>trq</i>	Calculated motor output torque when alarm occurred	Calculated motor output torque when alarm occurred
6.04	<i>Fref</i>	Frequency specified by frequency command when alarm occurred	Frequency specified by frequency command when alarm occurred
6.05	<i>rot</i>	Rotation direction	Displays the current rotation direction when alarm occurred. F: forward, r reverse, _ _ _ _ : stop
6.06	<i>StAt1</i>	Running status	Running status in 4-digit hexadecimal format Refer to “Displaying running status (3.07) and running status 2 (3.23) in “3.4.3 Monitoring the running status “Drive Monitoring: 3.0PE” on page 3-23 for details.
6.07	<i>tME</i>	Cumulative run time	Displays the content of the cumulative power-ON time counter of the inverter when alarm occurred. Counter range: 0 to 65,535 hours Display range: 0 to 65535 When the count exceeds 65,535, the counter will be reset to “0” and start over again.
6.08	<i>noSt</i>	Number of startups	Displays the content of the motor startup counter (i.e., the number of run commands issued) when alarm occurred. Counter range: 0 to 65,535 times Display range: 0 to 65535 When the count exceeds 65,535, the counter will be reset to “0” and start over again.
6.09	<i>Edc</i>	DC link bus voltage	Displays the DC link bus voltage of the inverter main circuit. Unit: V (volts)
6.10	<i>t-int</i>	Temperature inside the inverter	Displays the temperature of the inverter heat sink when alarm occurred. Unit: °C
6.11	<i>t-Fin</i>	Max. temperature of heat sink	Displays the temperature of the inverter heat sink when alarm occurred. Unit: °C
6.12	<i>dio</i>	Terminal I/O signal status (displayed with ON/OFF of LED segments)	Refer to “Table 3.4-9 Display of I/O signal status with ON/OFF of each LED segment” and “Table 3.4-10 Display of I/O signal status in hexadecimal notation (example)” in “3.4.4 Checking I/O signal status “I/O Checking: 4.1.0”
6.13	<i>d1-H</i>	Terminal input signal status <input type="checkbox"/> (in hexadecimal)	
6.14	<i>do-H</i>	Terminal output signal status <input type="checkbox"/> (in hexadecimal)	
6.15	<i>noAL</i>	No. of consecutive occurrences	Shows how many times the same alarm has occurred consecutively.
6.16	<i>oLAP1</i>	Multiple alarm 1	Simultaneously occurring alarm code (1) (“ - - - -” is displayed if no alarm has occurred.)
6.17	<i>oLAP2</i>	Multiple alarm 2	Simultaneously occurring alarm code (2) (“ - - - -” is displayed if no alarm has occurred.)
6.18	<i>dioL</i>	Terminal I/O signal status under communications control (displayed with the ON/OFF of LED segments)	Displays the ON/OFF state of the digital I/O terminals under RS-485 communications control when alarm occurred. Refer to “Displaying control I/O signal terminals under communications control” in “3.4.4 Checking I/O signal status “I/O Checking: 4.1.0” for the display content.
6.19	<i>d1L-H</i>	Terminal input signal status under communications control (in hexadecimal)	
6.20	<i>doL-H</i>	Terminal output signal status under communications control (in hexadecimal)	
6.21	<i>Sub</i>	Error sub code	Secondary error code for an alarm.
6.22	<i>StAt2</i>	Running status 2	Displays running status 2 in 5-digit hexadecimal format. Refer to “Table 3.4-4 Running status 2 (3.23) bit assignment” in “3.4.3 Monitoring the running status “Drive Monitoring: 3.0PE” for details.
6.23	<i>SPEEd</i>	Detected value	Displays the detected speed value when alarm occurred.
6.24	<i>StAt3</i>	Running status 3	Displays running status 3 in 5-digit hexadecimal format. Refer to “Table 3.4-15 Running Status 3 (6.24) bit assignment” below for details.
6.25	<i>Sub.o1</i>	Multiple alarm sub code	Secondary error code for a multiple alarm

Features
 Main application examples
 Model variations
 Type number nomenclature
 Standard specifications
 Common specifications
 Terminal specifications
 Basic wiring diagram
 External dimensions
 Keypad
 Function codes
 Options
 Product warranty

Keypad Operation

Alarm Mode

If an abnormal condition arises, the protective function is invoked and issues an alarm, then the inverter automatically enters Alarm mode. At the same time, an alarm code appears on the LED monitor.

Releasing the alarm and switching to Running mode

Remove the cause of the alarm and press the key to release the alarm and return to Running mode. The alarm can be removed using the key only when the alarm code is displayed.

Displaying the status of inverter at the time of alarm

When the alarm code is displayed, you may check various running status information when the alarm occurred (output frequency and output current, etc.) by pressing the key. The monitor item number and data for each running status information will be displayed alternately. Further, you can view various information items on the running status of the inverter using the / key. The information displayed is the same as for menu number 6 "Alarm Information" in Programming mode. Refer to Table 3.4-14 in "3.4.6 Reading alarm information "Alarm Information: 6.Rt"

Pressing the key while the running status information is displayed returns to the alarm code display.

When the running status information is displayed after removal of the alarm cause, pressing the key twice returns to the alarm code display and releases the inverter from the alarm state. This means that the motor starts running if a run command has been received by this time.

Displaying the alarm history

It is possible to display the most recent 3 alarm codes in addition to the one currently displayed. Previous alarm codes can be displayed by pressing the / key while the current alarm code is displayed.

Switching to Programming mode

You can also switch to Programming mode by pressing "STOP + keys" simultaneously with the alarm displayed, and modify the function code data.

Function Codes

Drive control

The FRENIC-MEGA runs under any of the following control methods. Some function codes apply exclusively to the specific control method. The enable or disable status is indicated with an icon for each control method within the permissible setting range field in the function code list table.

Icon example: Under V/f control Enable: Disable:

Function code table permissible setting range field	Control target (H18)	Control method (F42)
	Speed (H18=0)	V/f control Dynamic torque vector control (F42=1) V/f control with slip compensation (F42=2)
		V/f control with speed sensor (F42=3) Dynamic torque vector control with speed sensor (F42=4)
		Sensorless vector control (F42=5)
		Vector control with speed sensor (F42=6)
		Sensorless vector control (synchronous motors) (F42=15)
		Vector control with sensor (synchronous motors) (F42=16)
	Torque (H18=2, 3)	Vector control (F42=5,6,16)

For details on the control method, refer to "Function code F42".
 Note) The FRENIC-MEGA is a general-purpose inverter whose operation is customized by frequency-basis function codes, like conventional inverters. Under the speed-basis drive control, however, the control target is a motor speed, not a frequency, so convert the frequency to the motor speed according to the following expression.

Conversion formula Motor speed (r/min) = 120 x frequency (Hz)/number of poles

Change during operation

Symbol	Change during operation	Reflecting and saving data
Y*	Available	When data is changed using the / keys, it is immediately reflected in the inverter operation. However, the changed values are not saved in the inverter at this time. To save the data to the inverter, press the key. If you use the key to exit without saving it with the key, the data before the change will be reflected in the inverter operation.
Y	Available	When data is changed using the / keys, it is not reflected in the inverter operation directly, but by pressing the key, the changed values will be reflected in the inverter operation and saved in the inverter.
N	Not available	—

Data copying

Symbol	Data copying
Y	It is copied.
Y1	If the inverter capacity is different, it is not copied.
Y2	If the voltage series is different, it is not copied.
N	It is not copied.

Function Codes

F codes :Fundamental functions

Function code	Name	Control method and Data setting range	Change when running	Data copying
F00	Data protection	<p>V/f PGV/f SLV PGV PM SLV PM PGV TRQ</p> <p>0: No data protection, no digital setting protection 1: With data protection, no digital setting protection 2: No data protection, with digital setting protection 3: With data protection, with digital setting protection</p>	Y	Y
F01	Frequency setting 1	<p>V/f PGV/f SLV PGV PM SLV PM PGV TRQ</p> <p>0: Keypad key operation (▲ / ▼ keys) 1: Analog voltage input (Terminal [12]) (from 0 to ±10 VDC) 2: Analog current input (Terminal [C1]) (4 to 20 mA DC) 3: Analog voltage input (Terminal [12]) + analog current input (Terminal [C1]) 5: Analog voltage input (Terminal [V2]) (from 0 to ±10 VDC) 6: Analog voltage input (Terminal [V3]) (from 0 to ±10 VDC) 7: UP/DOWN control 8: Keypad key operation (▲ / ▼ keys) (with balanceless bumpless) 10: Pattern operation 11: Digital input interface card OPC-DI (option) 12: Pulse train input</p>	N	Y
F02	Operation method	<p>V/f PGV/f SLV PGV PM SLV PM PGV TRQ</p> <p>0: Keypad operation (Rotation direction input: terminal block) 1: External signal (digital input) 2: Keypad operation (forward rotation) 3: Keypad operation (reverse rotation)</p>	N	Y
F03	Maximum output frequency 1	<p>V/f PGV/f SLV PGV PM SLV PM PGV TRQ</p> <p>5.0 to 599.0 Hz</p>	N	Y
F04	Base frequency 1	<p>V/f PGV/f SLV PGV PM SLV PM PGV TRQ</p> <p>5.0 to 599.0 Hz</p>	N	Y
F05	Rated voltage at base frequency 1	<p>V/f PGV/f SLV PGV PM SLV PM PGV TRQ</p> <p>0: AVR disable (output voltage proportional to power voltage) 80 to 240 V: AVR operation (200V series) 160 to 500 V: AVR operation (400 V series)</p>	N	Y2
F06	Maximum output voltage 1	<p>V/f PGV/f SLV PGV PM SLV PM PGV TRQ</p> <p>80 to 240 V: AVR operation (200V series) 160 to 500 V: AVR operation (400 V series)</p>	N	Y2
F07	Acceleration time 1	<p>V/f PGV/f SLV PGV PM SLV PM PGV TRQ</p>	Y	Y
F08	Deceleration time 1	<p>0.00 to 6000s * 0.00 is for acceleration and deceleration time cancel (when performing soft-start and stop externally)</p>	Y	Y
F09	Torque boost 1	<p>V/f PGV/f SLV PGV PM SLV PM PGV TRQ</p> <p>0.0 to 20.0% (% value against base frequency voltage 1)</p>	Y	Y
F10	Electronic thermal overload protection for motor 1 (Select motor characteristics)	<p>V/f PGV/f SLV PGV PM SLV PM PGV TRQ</p> <p>1: Enable (for a general-purpose motor with self-cooling fan) 2: Enable (for an inverter-driven motor with separately powered cooling fan)</p>	Y	Y
F11	(Operation level)	<p>V/f PGV/f SLV PGV PM SLV PM PGV TRQ</p> <p>0.00 A (disable), current value of 1 to 135% of inverter rated current set with A unit</p>	Y	Y1
F12	(Thermal time constant)	<p>0.5 to 75.0min</p>	Y	Y
F14	Restart mode after momentary power failure (operation selection)	<p>V/f PGV/f SLV PGV PM SLV PM PGV TRQ</p> <p>0: Trip immediately 1: Trip after a recovery from power failure 2: Trip after momentary deceleration is stopped 3: Continue to run (for heavy inertia load or general load) 4: Restart from frequency at power failure (for general load) 5: Restart from starting frequency</p>	Y	Y
F15	Frequency limiter (upper limit)	<p>V/f PGV/f SLV PGV PM SLV PM PGV TRQ</p>	Y	Y
F16	(Lower limit)	<p>0.0 to 599.0Hz</p>		
F18	Bias (for frequency setting 1)	<p>V/f PGV/f SLV PGV PM SLV PM PGV TRQ</p> <p>-100.00 to 100.00%</p>	Y*	Y
F20	DC braking 1 (starting frequency)	<p>V/f PGV/f SLV PGV PM SLV PM PGV TRQ</p> <p>0.0 to 60.0Hz</p>	Y	Y
F21	DC braking 1 (Operation level)	<p>V/f PGV/f SLV PGV PM SLV PM PGV TRQ</p> <p>0 to 100% (HHD specification), 0 to 80% (HND specification), 0 to 80% (HD specification), 0 to 60% (ND specification),</p>	Y	Y
F22	(Braking time)	<p>0.00 (disable): 0.01 to 30.00 s</p>	Y	Y

*2 A standard value is set for each capacity. *3 The rated current of the motor is set. For details, refer to the FRENIC-MEGA (G2) User's Manual.
 *10 6.00 s for 22 kW or less, and 20.00 s for 30 kW or more. *11 5.0 min. for 22 kW or less, and 10.0 min. for 30 kW or more.

Function Codes

F codes :Fundamental functions

Function code	Name	Control method and Data setting range	Change when running	Data copying																																											
F23	Starting frequency 1	<p>V/f PGV/f SLV PGV PM SLV PM PGV TRQ</p> <p>0.0 to 60.0 Hz If F42 = 5 or 15, 1.0 Hz is automatically set.</p>	Y	Y																																											
F24	(Holding time)	<p>V/f PGV/f SLV PGV PM SLV PM PGV TRQ</p> <p>0.00 to 10.00s</p>	Y	Y																																											
F25	Stop frequency	<p>V/f PGV/f SLV PGV PM SLV PM PGV TRQ</p> <p>0.0 to 60.0Hz</p>	Y	Y																																											
F26	Motor sound (Carrier frequency)	<p>V/f PGV/f SLV PGV PM SLV PM PGV TRQ</p> <table border="1"> <thead> <tr> <th rowspan="2"></th> <th colspan="2">HHD specification</th> <th colspan="2">HND specification</th> </tr> <tr> <th>FRN****G2S-2G</th> <th>FRN****G2□-4G</th> <th>FRN****G2S-2G</th> <th>FRN****G2□-4G</th> </tr> </thead> <tbody> <tr> <td>0.75 to 16 kHz</td> <td>0003 to 0288</td> <td>0002 to 0179</td> <td>0032 to 0088</td> <td>0018 to 0045</td> </tr> <tr> <td>0.75 to 10 kHz</td> <td>0346 to 0432</td> <td>0217 to 1480</td> <td>0115 to 0288</td> <td>0060 to 0179</td> </tr> <tr> <td>0.75 to 6 kHz</td> <td>-</td> <td>-</td> <td>0346 to 0432</td> <td>0217 to 1480</td> </tr> <tr> <th rowspan="2"></th> <th colspan="2">HD specification *102</th> <th colspan="2">ND specification *102</th> </tr> <tr> <th>FRN****G2S-2G</th> <th>FRN****G2□-4G</th> <th>FRN****G2S-2G</th> <th>FRN****G2□-4G</th> </tr> <tr> <td>0.75 to 10 kHz</td> <td>-</td> <td>0085 to 0179</td> <td>-</td> <td>-</td> </tr> <tr> <td>0.75 to 6 kHz</td> <td>-</td> <td>0217 to 1480</td> <td>-</td> <td>0085 to 1480</td> </tr> </tbody> </table>		HHD specification		HND specification		FRN****G2S-2G	FRN****G2□-4G	FRN****G2S-2G	FRN****G2□-4G	0.75 to 16 kHz	0003 to 0288	0002 to 0179	0032 to 0088	0018 to 0045	0.75 to 10 kHz	0346 to 0432	0217 to 1480	0115 to 0288	0060 to 0179	0.75 to 6 kHz	-	-	0346 to 0432	0217 to 1480		HD specification *102		ND specification *102		FRN****G2S-2G	FRN****G2□-4G	FRN****G2S-2G	FRN****G2□-4G	0.75 to 10 kHz	-	0085 to 0179	-	-	0.75 to 6 kHz	-	0217 to 1480	-	0085 to 1480	Y	Y
	HHD specification			HND specification																																											
	FRN****G2S-2G	FRN****G2□-4G	FRN****G2S-2G	FRN****G2□-4G																																											
0.75 to 16 kHz	0003 to 0288	0002 to 0179	0032 to 0088	0018 to 0045																																											
0.75 to 10 kHz	0346 to 0432	0217 to 1480	0115 to 0288	0060 to 0179																																											
0.75 to 6 kHz	-	-	0346 to 0432	0217 to 1480																																											
	HD specification *102		ND specification *102																																												
	FRN****G2S-2G	FRN****G2□-4G	FRN****G2S-2G	FRN****G2□-4G																																											
0.75 to 10 kHz	-	0085 to 0179	-	-																																											
0.75 to 6 kHz	-	0217 to 1480	-	0085 to 1480																																											
F27	(Tone)	<p>V/f PGV/f SLV PGV PM SLV PM PGV TRQ</p> <p>0: Level 0 (disable) 1: Level 1 2: Level 2 3: Level 3</p>	Y	Y																																											
F29	Terminal [FM1] (Operation selection)	<p>V/f PGV/f SLV PGV PM SLV PM PGV TRQ</p> <p>0: Voltage output (0 to +10 VDC) 1: Current output (4 to 20 mA DC) 2: Current output (0 to 20 mA DC) 4: Voltage output (0 to +10 VDC)</p>	Y	Y																																											
F30	(Output gain)	0 to 300%	Y*	Y																																											
F31	(Function selection)	<p>V/f PGV/f SLV PGV PM SLV PM PGV TRQ</p> <p>0: Output frequency 1 (before slip compensation) 1: Output frequency 2 (after slip compensation) 2: Output current 3: Output voltage when alarm occurred 4: Output torque 5: Load factor 6: Power consumption 7: PID feedback value 8: Actual speed/estimated speed 9: DC link bus voltage 10: Universal AO 11: Analog output test (-) 13: Motor output 14: Calibration (+) 15: PID command (SV) 16: PID output (MV) 17: Master-follower angle deviation 18: Inverter cooling fin temperature 21: PG feedback value 22: Torque current command 23: PID deviation 24: Line speed command 25: Winding diameter calculation value 26: Setting frequency (before acceleration/deceleration calculation) 50: PID control 1 feedback value (PV1) *101 51: PID control 1 command (SV1) *101 52: PID control 1 deviation (ERR1) *101 54: PID control 2 feedback value (PV2) *101 55: PID control 2 command (SV2) *101 56: PID control 2 deviation (ERR2) *101 60: External PID control 1 feedback value (EPID1-PV) *101 61: External PID control 1 command (EPID1-SV) *101 62: External PID control 1 deviation (EPID1-ERR) *101 63: External PID control 1 final deviation (EPID1-ERR) *101 65: External PID control 1 final output (EPID1-OUT) *101 70: External PID control 2 feedback value (EPID2-PV) *101 71: External PID control 2 command (EPID2-SV) *101 72: External PID control 2 deviation (EPID2-ERR) *101 75: External PID control 2 final output (EPID2-OUT) *101 80: External PID control 3 feedback value (EPID3-PV) *101 81: External PID control 3 command (EPID3-SV) *101 82: External PID control 3 deviation (EPID3-ERR) *101 85: External PID control 3 final output (EPID3-OUT) *101 111 to 124: Customizable logic output signal 1 to 14 *101</p>	Y	Y																																											

*101 Compatible with software version ROM0500 or later.

*102 Compatible with software version ROM0600 or later

Function code	Name	Control method and Data setting range	Change when running	Data copying
F32	Terminal [FM2] (Operation selection)	Same as F29	Y	Y
F33	Terminal [FMP] (Pulse rate)	<input type="checkbox"/> V/f <input type="checkbox"/> PGV/f <input type="checkbox"/> SLV <input type="checkbox"/> PGV <input type="checkbox"/> PM SLV <input type="checkbox"/> PM PGV <input type="checkbox"/> TRQ 25 to 6000 p/s (number of pulse at 100%)	Y*	Y
F34	(Output gain)	<input type="checkbox"/> V/f <input type="checkbox"/> PGV/f <input type="checkbox"/> SLV <input type="checkbox"/> PGV <input type="checkbox"/> PM SLV <input type="checkbox"/> PM PGV <input type="checkbox"/> TRQ 0,1 to 300% 0: Pulse output 1 to 300%	Y*	Y
F35	(Function selection)	Same as F31	Y	Y
F37	Load selection/ Auto torque boost/ Auto energy-saving operation 1	<input type="checkbox"/> V/f <input type="checkbox"/> PGV/f <input type="checkbox"/> SLV <input type="checkbox"/> PGV <input type="checkbox"/> PM SLV <input type="checkbox"/> PM PGV <input type="checkbox"/> TRQ 0: Quadratic-torque load 1: Constant torque load 2: Auto torque boost 3: Auto energy-saving operation (quadratic-torque load) 4: Auto energy-saving operation (constant torque load) 5: Auto energy-saving operation with auto torque boost	N	Y
F38	Stop frequency (detection mode)	<input type="checkbox"/> V/f <input type="checkbox"/> PGV/f <input type="checkbox"/> SLV <input checked="" type="checkbox"/> PGV <input type="checkbox"/> PM SLV <input type="checkbox"/> PM PGV <input type="checkbox"/> TRQ 0: Speed detection value / estimated speed 1: Reference speed	N	Y
F39	(Holding time)	<input type="checkbox"/> V/f <input type="checkbox"/> PGV/f <input type="checkbox"/> SLV <input type="checkbox"/> PGV <input type="checkbox"/> PM SLV <input type="checkbox"/> PM PGV <input type="checkbox"/> TRQ 0.00 to 10.00s	Y	Y
F40	Torque limiter 1-1	<input type="checkbox"/> V/f <input type="checkbox"/> PGV/f <input type="checkbox"/> SLV <input type="checkbox"/> PGV <input type="checkbox"/> PM SLV <input type="checkbox"/> PM PGV <input type="checkbox"/> TRQ	Y	Y
F41	Torque limiter 1-2	-300 to 0 to 300% ; 999 (Disable)	Y	Y
F42	Drive control selection 1	<input type="checkbox"/> V/f <input type="checkbox"/> PGV/f <input type="checkbox"/> SLV <input type="checkbox"/> PGV <input type="checkbox"/> PM SLV <input type="checkbox"/> PM PGV <input type="checkbox"/> TRQ 0: V/f control without slip compensation 1: Dynamic torque vector control 2: V/f control with slip compensation 3: V/f control with speed sensor 4: Dynamic torque vector control with sensor 5: Sensorless vector control 6: Vector control with speed sensor 15: Sensorless vector control (synchronous motors) 16: Vector control with sensor (synchronous motors)	N	Y
F43	Current limiter (mode selection)	<input type="checkbox"/> V/f <input type="checkbox"/> PGV/f <input type="checkbox"/> SLV <input type="checkbox"/> PGV <input type="checkbox"/> PM SLV <input type="checkbox"/> PM PGV <input type="checkbox"/> TRQ 0: Disable 1: Enable at constant speed (disable during ACC/DEC) 2: Enable during ACC/constant speed operation (disable during DEC)	Y	Y
F44	(Operation level)	20 to 200% (rated current of the inverter for 100%)	Y	Y
F50	Electronic thermal overload (for braking resistor protection) (discharging capacity)	<input type="checkbox"/> V/f <input type="checkbox"/> PGV/f <input type="checkbox"/> SLV <input type="checkbox"/> PGV <input type="checkbox"/> PM SLV <input type="checkbox"/> PM PGV <input type="checkbox"/> TRQ 0 (If using built-in braking resistor) 1 to 9000 kW OFF (cancel)	Y	Y1 Y2
F51	(Permissible average loss)	0.001 to 99.99kW	Y	Y1 Y2
F52	(Braking resistance value)	0.01 to 999Ω	Y	Y1 Y2
F58	Terminal [FM1] (Filter)	<input type="checkbox"/> V/f <input type="checkbox"/> PGV/f <input type="checkbox"/> SLV <input type="checkbox"/> PGV <input type="checkbox"/> PM SLV <input type="checkbox"/> PM PGV <input type="checkbox"/> TRQ 0.00 to 5.00s	Y	Y
F59	(Bias)	-100.0 to 100.0%	Y*	Y
F60	Terminal [FM2] (Output gain)	<input type="checkbox"/> V/f <input type="checkbox"/> PGV/f <input type="checkbox"/> SLV <input type="checkbox"/> PGV <input type="checkbox"/> PM SLV <input type="checkbox"/> PM PGV <input type="checkbox"/> TRQ 0 to 300%	Y*	Y
F61	(Function selection)	Same as F31	Y	Y
F62	(Filter)	0.00 to 5.00s	Y	Y
F63	(Bias)	-100.0 to 100.0%	Y*	Y
F64	Terminal [FMP] (Filter)	<input type="checkbox"/> V/f <input type="checkbox"/> PGV/f <input type="checkbox"/> SLV <input type="checkbox"/> PGV <input type="checkbox"/> PM SLV <input type="checkbox"/> PM PGV <input type="checkbox"/> TRQ 0.00 to 5.00s	Y	Y
F80	HHD/HND switching	<input type="checkbox"/> V/f <input type="checkbox"/> PGV/f <input type="checkbox"/> SLV <input type="checkbox"/> PGV <input type="checkbox"/> PM SLV <input type="checkbox"/> PM PGV <input type="checkbox"/> TRQ 0: HHD specification 1: HND specification 3: HD specification *102 4: ND specification *102	N	Y

*12 180% for 15 kW or less, and 160% for 22 kW or more.
*13 0 for 7.5 kW or less, and OFF for 11 kW or more.
*102 Compatible with software version ROM0600 or later

Features
Main application examples
Model variations
Type number nomenclature
Standard specifications
Common specifications
Terminal specifications
Basic wiring diagram
External dimensions
Keypad
Function codes
Options
Product warranty

Function Codes

E codes :Extension Terminal Functions (terminal functions)

Function code	Name	Control method and Data setting range	Change when running	Data copying
E01	Terminal [X1] (Function selection)	Table 1 Refer to E01 to E09 in the control input terminal setting table.	N	Y
E02	Terminal [X2]		N	Y
E03	Terminal [X3]		N	Y
E04	Terminal [X4]		N	Y
E05	Terminal [X5]		N	Y
E06	Terminal [X6]		N	Y
E07	Terminal [X7]		N	Y
E08	Terminal [X8]		N	Y
E09	Terminal [X9]		N	Y

Table 1 Control input terminal setting table

Function code and Name				Control method and Data setting range
E01 to E09	E70	E98,E99	o101 to o116	
Terminal [X1] to [X9]	Keypad M/shift key	Terminal [FWD][REV]	Terminal [I1] to [I16] (for OPC-DI)	
Y	Y	Y	Y	<div style="display: flex; justify-content: space-between; font-size: 8px; font-weight: bold;"> V/f PGV/f SLV PGV PM SLV PM PGV TRQ </div> 0 (1000): Multistep frequency selection (0 to 1 steps) [SS1] 1 (1001): Select multistep frequency (0 to 3 steps) [SS2] 2 (1002): Select multistep frequency (0 to 7 steps) [SS4] 3 (1003): Select multistep frequency (0 to 15 steps) [SS8]
Y	Y	Y	Y	4 (1004): Select ACC/DEC time (2 steps) [RT1] 5 (1005): Select ACC/DEC time (4 steps) [RT2]
Y	Y	Y	Y	<div style="display: flex; justify-content: space-between; font-size: 8px; font-weight: bold;"> V/f PGV/f SLV PGV PM SLV PM PGV TRQ </div> 6 (1006): Select 3-wire operation [HLD]
Y	Y	Y	Y	7 (1007): Coast to a stop command [BX]
Y	N	Y	Y	8 (1008): Reset alarm (Abnormal) [RST]
Y	N	Y	Y	9 (1009): External alarm (0 = Active OFF/1009 = Active ON) [THR]
Y	Y	Y	Y	<div style="display: flex; justify-content: space-between; font-size: 8px; font-weight: bold;"> V/f PGV/f SLV PGV PM SLV PM PGV TRQ </div> 10 (1010): Ready for jogging [JOG]
Y	Y	Y	Y	11 (1011): Select frequency setting 2/ frequency setting 1 [Hz2/Hz1]
Y	Y	Y	Y	<div style="display: flex; justify-content: space-between; font-size: 8px; font-weight: bold;"> V/f PGV/f SLV PGV PM SLV PM PGV TRQ </div> 12 (1012): Select motor 2 [M2]
Y	Y	Y	Y	<div style="display: flex; justify-content: space-between; font-size: 8px; font-weight: bold;"> V/f PGV/f SLV PGV PM SLV PM PGV TRQ </div> 13: DC braking command PM SLV is valid only when P30 = 0 [DCBRK]
Y	Y	Y	Y	<div style="display: flex; justify-content: space-between; font-size: 8px; font-weight: bold;"> V/f PGV/f SLV PGV PM SLV PM PGV TRQ </div> 14 (1014): Select torque limit 2/ torque limit 1 [TL2/TL1]
Y	N	Y	Y	<div style="display: flex; justify-content: space-between; font-size: 8px; font-weight: bold;"> V/f PGV/f SLV PGV PM SLV PM PGV TRQ </div> 15: Switch to commercial power (50 Hz) [SW50] 16: Switch to commercial power (60 Hz) [SW60]
Y	N	Y	Y	<div style="display: flex; justify-content: space-between; font-size: 8px; font-weight: bold;"> V/f PGV/f SLV PGV PM SLV PM PGV TRQ </div> 17 (1017): UP command [UP] 18 (1018): DOWN command [DOWN]
Y	Y	Y	Y	<div style="display: flex; justify-content: space-between; font-size: 8px; font-weight: bold;"> V/f PGV/f SLV PGV PM SLV PM PGV TRQ </div> 19 (1019): Allow function code editing (data change enabled) [WE-KP]
Y	Y	Y	Y	<div style="display: flex; justify-content: space-between; font-size: 8px; font-weight: bold;"> V/f PGV/f SLV PGV PM SLV PM PGV TRQ </div> 20 (1020): Cancel PID control [Hz/PID]
Y	Y	Y	Y	21 (1021): Switch normal/ inverse operation [IVS]
Y	N	Y	Y	<div style="display: flex; justify-content: space-between; font-size: 8px; font-weight: bold;"> V/f PGV/f SLV PGV PM SLV PM PGV TRQ </div> 22 (1022): Interlock [IL]
Y	Y	Y	Y	<div style="display: flex; justify-content: space-between; font-size: 8px; font-weight: bold;"> V/f PGV/f SLV PGV PM SLV PM PGV TRQ </div> 23 (1023): Cancel torque control [Hz/TRQ]
Y	Y	Y	Y	<div style="display: flex; justify-content: space-between; font-size: 8px; font-weight: bold;"> V/f PGV/f SLV PGV PM SLV PM PGV TRQ </div> 24 (1024): Select link operation (RS-485, BUS option) [LE]
Y	N	Y	Y	25 (1025): Universal DI [U-DI]
Y	Y	Y	Y	<div style="display: flex; justify-content: space-between; font-size: 8px; font-weight: bold;"> V/f PGV/f SLV PGV PM SLV PM PGV TRQ </div> 26 (1026): Select auto search for idling motor speed at starting [STM]
Y	Y	Y	Y	<div style="display: flex; justify-content: space-between; font-size: 8px; font-weight: bold;"> V/f PGV/f SLV PGV PM SLV PM PGV TRQ </div> 30 (1030): Force to stop (30 = Active OFF/1030 = Active ON) [STOP]
Y	Y	Y	Y	<div style="display: flex; justify-content: space-between; font-size: 8px; font-weight: bold;"> V/f PGV/f SLV PGV PM SLV PM PGV TRQ </div> 32 (1032): Pre-excite [EXITE]

Function code and Name				Control method and Data setting range
E01 to E09	E70	E98,E99	o101 to o116	
Terminal [X1] to [X9]	Keypad M/shift key	Terminal [FWD][REV]	Terminal [I1] to [I16] (for OPC-DI)	
Y	Y	Y	Y	<div style="display: flex; justify-content: space-between; align-items: center;"> V/f PGV/f SLV PGV PM SLV PM PGV TRQ </div> 33 (1033): Reset PID integral and differential terms [PID-RST]
				34 (1034): Hold PID integral term [PID-HLD]
Y	Y	Y	Y	<div style="display: flex; justify-content: space-between; align-items: center;"> V/f PGV/f SLV PGV PM SLV PM PGV TRQ </div> 35 (1035): Local (keypad) command selection [LOC]
Y	Y	Y	Y	<div style="display: flex; justify-content: space-between; align-items: center;"> V/f PGV/f SLV PGV PM SLV PM PGV TRQ </div> 36 (1036): Select motor 3 [M3]
				37 (1037): Select motor 4 [M4]
Y	Y	Y	Y	38 (1038): Drive permission *100 [RE]
Y	Y	Y	Y	<div style="display: flex; justify-content: space-between; align-items: center;"> V/f PGV/f SLV PGV PM SLV PM PGV TRQ </div> 39: Condensation prevention [DWP]
Y	Y	Y	Y	<div style="display: flex; justify-content: space-between; align-items: center;"> V/f PGV/f SLV PGV PM SLV PM PGV TRQ </div> 40: Switch to commercial power built-in sequence (50 Hz) [ISW50]
				41: Switch to commercial power built-in sequence (60 Hz) [ISW60]
Y	N	Y	Y	<div style="display: flex; justify-content: space-between; align-items: center;"> V/f PGV/f SLV PGV PM SLV PM PGV TRQ </div> 42 (1042): Activate the limit switch at start point [LS]
Y	Y	Y	Y	<div style="display: flex; justify-content: space-between; align-items: center;"> V/f PGV/f SLV PGV PM SLV PM PGV TRQ </div> 46 (1046): Overload stop enable command [OLS]
Y	Y	Y	Y	<div style="display: flex; justify-content: space-between; align-items: center;"> V/f PGV/f SLV PGV PM SLV PM PGV TRQ </div> 47 (1047): Servo lock command [LOCK]
Y ^{#1}	N	N	N	<div style="display: flex; justify-content: space-between; align-items: center;"> V/f PGV/f SLV PGV PM SLV PM PGV TRQ </div> 48: Pulse train input * Terminal [X7] only (E06, E07) [PIN]
Y ^{#2}	Y	Y	Y	49 (1049): Pulse train sign terminal [SIGN] * Other than terminal [X6] and [X7] (E01 to E05, E08, E09)
Y	N	Y	Y	<div style="display: flex; justify-content: space-between; align-items: center;"> V/f PGV/f SLV PGV PM SLV PM PGV TRQ </div> 50 (1050): Drive motor fixed-time switching time clear command *101 [MCLR]
Y	Y	Y	Y	<div style="display: flex; justify-content: space-between; align-items: center;"> V/f PGV/f SLV PGV PM SLV PM PGV TRQ </div> 58(1058) :UP/DOWN frequency clear [STZ]
Y	Y	Y	Y	<div style="display: flex; justify-content: space-between; align-items: center;"> V/f PGV/f SLV PGV PM SLV PM PGV TRQ </div> 59 (1059): Battery operation selection [BATRY]
Y	Y	Y	Y	<div style="display: flex; justify-content: space-between; align-items: center;"> V/f PGV/f SLV PGV PM SLV PM PGV TRQ </div> 60 (1060): Select torque bias 1 [TB1]
				61 (1061): Select torque bias 2 [TB2]
				62 (1062): Hold torque bias [H-TB]
Y	N	Y	Y	<div style="display: flex; justify-content: space-between; align-items: center;"> V/f PGV/f SLV PGV PM SLV PM PGV TRQ </div> 65 (1065): Check brake [BRKE]
Y	Y	Y	Y	<div style="display: flex; justify-content: space-between; align-items: center;"> V/f PGV/f SLV PGV PM SLV PM PGV TRQ </div> 70 (1070): Cancel line speed control [Hz/LSC]
				71 (1071): Hold line speed control frequency in the memory [LSC-HLD]
Y	N	Y	Y	<div style="display: flex; justify-content: space-between; align-items: center;"> V/f PGV/f SLV PGV PM SLV PM PGV TRQ </div> 72 (1072): Count the run time of commercial power-driven motor 1 [CRUN-M1]
				73 (1073): Count the run time of commercial power-driven motor 2 [CRUN-M2]
				74 (1074): Count the run time of commercial power-driven motor 3 [CRUN-M3]
				75 (1075): Count the run time of commercial power-driven motor 4 [CRUN-M4]
Y	Y	Y	Y	<div style="display: flex; justify-content: space-between; align-items: center;"> V/f PGV/f SLV PGV PM SLV PM PGV TRQ </div> 76 (1076): Select droop control [DROOP]
Y	Y	Y	Y	<div style="display: flex; justify-content: space-between; align-items: center;"> V/f PGV/f SLV PGV PM SLV PM PGV TRQ </div> 77 (1077): Speed deviation error cancel [PG-CCL]
Y	Y	Y	Y	<div style="display: flex; justify-content: space-between; align-items: center;"> V/f PGV/f SLV PGV PM SLV PM PGV TRQ </div> 78 (1078): Speed control parameter selection 1 [MPRM1]
				79 (1079): Speed control parameter selection 2 [MPRM2]
Y	Y	Y	Y	<div style="display: flex; justify-content: space-between; align-items: center;"> V/f PGV/f SLV PGV PM SLV PM PGV TRQ </div> 80 (1080): Cancel customizable logic [CLC]
				81 (1081): Clear all customizable logic timers [CLTC]
Y	Y	Y	Y	<div style="display: flex; justify-content: space-between; align-items: center;"> V/f PGV/f SLV PGV PM SLV PM PGV TRQ </div> 82 (1082): Anti-regenerative control cancel [AR-CCL]
Y	Y	Y	Y	<div style="display: flex; justify-content: space-between; align-items: center;"> V/f PGV/f SLV PGV PM SLV PM PGV TRQ </div> 83 (1083): PG input switching [PG-SEL]

*100 Compatible with software version ROM0300 or later.
 *101 Compatible with software version ROM0500 or later.

Features
Main application examples
Model variations
Type number nomenclature
Standard specifications
Common specifications
Terminal specifications
Basic wiring diagram
External dimensions
Keypad
Function codes
Options
Product warranty

Function Codes

E codes :Extension Terminal Functions (terminal functions)

Table 1 Control input terminal setting table

Function code and Name				Control method and Data setting range
E01 to E09	E70	E98,E99	o101 to o116	
Terminal [X1] to [X9]	Keypad M/shift key	Terminal [FWD][REV]	Terminal [I1] to [I16] (for OPC-DI)	
Y	Y	Y	Y	<div style="display: flex; justify-content: space-between;"> V/f PGV/f SLV PGV PM SLV PM PGV TRQ </div> 84 (1084): Acceleration/deceleration cancel (bypass) [BPS]
Y	N	Y	Y	<div style="display: flex; justify-content: space-between;"> V/f PGV/f SLV PGV PM SLV PM PGV TRQ </div> 87 (1087): Drive command 2/Drive command 1 *100 [FR2/FR1] 88: Forward rotation and stop command 2 *100 [FWD2] 89: Reverse rotation and stop command 2 *100 [REV2]
Y	Y	Y	Y	<div style="display: flex; justify-content: space-between;"> V/f PGV/f SLV PGV PM SLV PM PGV TRQ </div> 94: Forward rotation JOG [FJOG] 95: Reverse rotation JOG [RJOG]
Y	Y	Y	Y	<div style="display: flex; justify-content: space-between;"> V/f PGV/f SLV PGV PM SLV PM PGV TRQ </div> 97 (1097): Direction command [DIR]
N	N	Y	N	<div style="display: flex; justify-content: space-between;"> V/f PGV/f SLV PGV PM SLV PM PGV TRQ </div> 98: Forward rotation and stop command [FWD] 99: Reverse rotation and stop command [REV]
Y	Y	Y	Y	<div style="display: flex; justify-content: space-between;"> V/f PGV/f SLV PGV PM SLV PM PGV TRQ </div> 100: No assignment [NONE]
Y	Y	Y	Y	<div style="display: flex; justify-content: space-between;"> V/f PGV/f SLV PGV PM SLV PM PGV TRQ </div> 105 (1105): Light load automatic double speed judgment permission [LAC-ENB]
Y	Y	Y	Y	<div style="display: flex; justify-content: space-between;"> V/f PGV/f SLV PGV PM SLV PM PGV TRQ </div> 110 (1110): Servo lock gain selection [SLG2]
Y	N	Y	Y	<div style="display: flex; justify-content: space-between;"> V/f PGV/f SLV PGV PM SLV PM PGV TRQ </div> 111 (1111): Forced stop (terminal block only) [STOP-T] (111 = Active OFF/1111 = Active ON)
Y	Y	Y	Y	<div style="display: flex; justify-content: space-between;"> V/f PGV/f SLV PGV PM SLV PM PGV TRQ </div> 116 (1116): AVR cancel [AVR-CCL]
Y	Y	Y	Y	<div style="display: flex; justify-content: space-between;"> V/f PGV/f SLV PGV PM SLV PM PGV TRQ </div> 119 (1119): Speed regulator P selection [P-SEL]
Y	Y	Y	Y	<div style="display: flex; justify-content: space-between;"> V/f PGV/f SLV PGV PM SLV PM PGV TRQ </div> 121 (1121) to 129(1129): Customizable logic input 1 to 9 "CLI1" to [CLI1]~[CLI9]
Y	Y	Y	Y	<div style="display: flex; justify-content: space-between;"> V/f PGV/f SLV PGV PM SLV PM PGV TRQ </div> 130 (1130): Boost command *101 [BST] 131 (1131): Flow switch *101 [FS] 132 (1132): Filter clogging reverse command *101 [FRC] 133 (1133): PID channel switching *101 [PID2/1]
Y	Y	Y	Y	<div style="display: flex; justify-content: space-between;"> V/f PGV/f SLV PGV PM SLV PM PGV TRQ </div> 134 (1134): Forced operation command [FMS]
Y	Y	Y	Y	<div style="display: flex; justify-content: space-between;"> V/f PGV/f SLV PGV PM SLV PM PGV TRQ </div> 135 (1135): Travel/absolute position switching [INC/ABS]
Y	Y	Y	Y	<div style="display: flex; justify-content: space-between;"> V/f PGV/f SLV PGV PM SLV PM PGV TRQ </div> 136 (1136): Orientation command [ORT]
Y	Y	Y	Y	<div style="display: flex; justify-content: space-between;"> V/f PGV/f SLV PGV PM SLV PM PGV TRQ </div> 137 (1137): Position control/speed control switching [POS/Hz] 138 (1138): Homing command [ORG]
Y	N	Y	Y	139 (1139): + direction overtravel [+OT] 140 (1140): - direction overtravel [-OT]
Y	Y	Y	Y	141 (1141): Position clear command [P-CLR] 142 (1142): Position preset command [P-PRESET] 143 (1143): Teaching command [TEACH]
Y	Y	Y	Y	144 (1144): Positioning data change command [POS-SET] 145 (1145): Positioning data selection [POS-SEL1] 146 (1146): Positioning data selection [POS-SEL2] 147 (1147): Positioning data selection 4 [POS-SEL4]
Y	N	Y	Y	<div style="display: flex; justify-content: space-between;"> V/f PGV/f SLV PGV PM SLV PM PGV TRQ </div> 149 (1149): Pump control switching command *101 [PCHG] 150 (1150): Rotary control master motor *101 [MEN0] 151 (1151): Pump control motor 1 *101 [MEN1] 152 (1152): Pump control motor 2 *101 [MEN2] 153 (1153): Pump control motor 3Φ *101 [MEN3]

*100 Compatible with software version ROM0300 or later.
 *101 Compatible with software version ROM0500 or later.

Function code and Name				Control method and Data setting range
E01 to E09	E70	E98,E99	o101 to o116	
Terminal [X1] to [X9]	Keypad M/shift key	Terminal [FWD][REV]	Terminal [I1] to [I16] (for OPC-DI)	
Y	N	Y	Y	V/f PGV/f SLV PGV PM SLV PM PGV TRQ 154 (1154): Pump control motor 4 *101 [MEN4]
				155 (1155): Pump control motor 5 *101 [MEN5]
				156 (1156): Pump control motor 6 *101 [MEN6]
				157 (1157): Pump control motor 7 *101 [MEN7]
				158 (1158): Pump control motor 8 *101 [MEN8]
				V/f PGV/f SLV PGV PM SLV PM PGV TRQ 159 (1159): For manufacturer adjustment *101 [ICSW]
				160 (1160): For manufacturer adjustment *101 [ICFB]
				161 (1161): For manufacturer adjustment *101 [LCFB]
Y	N	Y	Y	V/f PGV/f SLV PGV PM SLV PM PGV TRQ 169 (1169): Initial diameter set command [D-SET]
				170 (1170): Winding diameter calculation hold command [D-HLD]
Y	Y	Y	Y	V/f PGV/f SLV PGV PM SLV PM PGV TRQ 171 (1171): PID control multistage command 1 [PID-SS1]
				172 (1172): PID control multistage command [PID-SS2]
Y	Y	Y	Y	V/f PGV/f SLV PGV PM SLV PM PGV TRQ 181 (1181): External PID multi-stage command 1 *101 [EPID-SS1]
				182 (1182): External PID multi-stage command 2 *101 [EPID-SS2]
				190 (1190): Scheduled drive cancellation *101 [TMC]
				191 (1191): Schedule 1 enabled *101 [TM1]
				192 (1192): Schedule 2 enabled *101 [TM2]
				193 (1193): Schedule 3 enabled *101 [TM3]
				194 (1194): Schedule 4 enabled *101 [TM4]
				201 (1201): External PID control 1 ON command *101 [EPID1-ON]
				202 (1202): External PID control 1 cancellation *101 [%/EPID1]
				203 (1203): External PID 1 positive/negative switching *101 [EPID1-IVS]
				204 (1204): External PID 1 integral/differential reset *101 [EPID1-RST]
				205 (1205): External PID 1 integral hold *101 [EPID1-HLD]
				211 (1211): External PID control 2 ON command *101 [EPID2-ON]
				212 (1212): External PID control 2 cancellation *101 [%/EPID2]
				213 (1213): External PID 2 positive/negative switching *101 [EPID2-IVS]
				214 (1214): External PID 2 integral/differential reset *101 [EPID2-RST]
				215 (1215): External PID 2 integral hold *101 [EPID2-HLD]
221 (1221): External PID control 3 ON command *101 [EPID3-ON]				
222 (1222): External PID control 3 cancellation *101 [%/EPID3]				
223 (1223): External PID 3 positive/negative switching *101 [EPID3-IVS]				
224 (1224): External PID 3 integral/differential reset *101 [EPID3-RST]				
225 (1225): External PID 3 integral hold *101 [EPID3-HLD]				

Note) () indicates logical inversion. (Short circuit - OFF)

*101 Compatible with software version ROM0500 or later.

Features
Main application examples
Model variations
Type number nomenclature
Standard specifications
Common specifications
Terminal specifications
Basic wiring diagram
External dimensions
Keypad
Function codes
Options
Product warranty

Function Codes

E codes :Extension Terminal Functions (terminal functions)

Table 1 Control input terminal setting table

Function code	Name	Control method and Data setting range	Change when running	Data copying
E10	Acceleration time 2	V/f PGV/f SLV PGV PM SLV PM PGV TRQ 0.00 to 6000 s	Y	Y
E11	Deceleration time 2	0.00 to 6000 s	Y	Y
E12	Acceleration time 3	* 0.00 is for acceleration and deceleration time cancel (when performing soft-start and stop externally)	Y	Y
E13	Deceleration time 3		Y	Y
E14	Acceleration time 4		Y	Y
E15	Deceleration time 4		Y	Y
E16	Torque limiter 2-1	V/f PGV/f SLV PGV PM SLV PM PGV TRQ -300 to 0 to 300%; 999 (Disable)	Y	Y
E17	Torque limiter 2-2		Y	Y
E20	Terminal [Y1] (Function selection)	Table 2 Refer to E20 to E27 in the control input terminal setting table.	N	Y
E21	Terminal [Y2]		N	Y
E22	Terminal [Y3]		N	Y
E23	Terminal [Y4]		N	Y
E24	Terminal [Y5A/C] (Ry output)		N	Y
E27	Terminal [30A/B/C] (Ry output)		N	Y

*10 FRN0.4 to 22G2S/E/P-2J/4J is 6.00 s, and FRN30 to 630G2S/E/H/P-2J/4J is 20.00 s.

Table 2 Control input terminal setting table

Function code and Name					Control method and Data setting range
E20 to E24, E27	E71	o01 to o07 *101	o23 to o26	o121 to o128	
Terminal [Y1] to [Y4], [Y5A/C], [30A/B/C]	Keypad M-LED indicator	Terminal [Y6A/C] to [Y12A/C] (for OPC-RY2)	Terminal [Y1A/B/C] to [Y4A/B/C] (for OPC-RY)	Terminal [01] to [08] (for OPC-DO)	
Y	Y	Y	Y	Y	V/f PGV/f SLV PGV PM SLV PM PGV TRQ 0 (1000): Inverter running [RUN]
Y	Y	Y	Y	Y	V/f PGV/f SLV PGV PM SLV PM PGV TRQ 1 (1001): Frequency (speed) arrival [FAR]
Y	Y	Y	Y	Y	V/f PGV/f SLV PGV PM SLV PM PGV TRQ 2 (1002): Frequency (speed) detected [FDT]
Y	Y	Y	Y	Y	3 (1003): Under voltage detected (inverter stopped) [LU]
Y	Y	Y	Y	Y	4 (1004): Detected torque polarity [B/D]
Y	Y	Y	Y	Y	5 (1005): Inverter output limiting [IOL]
Y	Y	Y	Y	Y	6 (1006): Auto-restarting after momentary power failure [IPF]
Y	Y	Y	Y	Y	7 (1007): Motor overload early warning [OL]
Y	Y	Y	Y	Y	8 (1008): Keypad operation [KP]
Y	Y	Y	Y	Y	10 (1010): Inverter ready to run [RDY]
Y	N	Y	Y	Y	V/f PGV/f SLV PGV PM SLV PM PGV TRQ 11: Commercial/inverter power supply switching [SW88] 12: Commercial/inverter power supply switching [SW52-2] 13: Commercial/inverter power supply switching [SW52-1]
Y	N	Y	Y	Y	V/f PGV/f SLV PGV PM SLV PM PGV TRQ 15 (1015): Switch MC on the input power lines [AX]
Y	Y	Y	Y	Y	V/f PGV/f SLV PGV PM SLV PM PGV TRQ 16 (1016): Pattern operation stage transition [TU] 17 (1017): Pattern operation cycle completed [TO] 18 (1018): Pattern operation stage 1 [STG1] 19 (1019): Pattern operation stage 2 [STG2] 20 (1020): Pattern operation stage 4 [STG4]
Y	Y	Y	Y	Y	V/f PGV/f SLV PGV PM SLV PM PGV TRQ 21 (1021): Frequency (speed) arrival 2 [FAR2]
Y	Y	Y	Y	Y	V/f PGV/f SLV PGV PM SLV PM PGV TRQ 22 (1022): Inverter output limiting with delay [IOL2]
Y	Y	Y	Y	Y	V/f PGV/f SLV PGV PM SLV PM PGV TRQ 25 (1025): Cooling fan in operation [FAN]
Y	Y	Y	Y	Y	V/f PGV/f SLV PGV PM SLV PM PGV TRQ 26 (1026): Auto-resetting [TRY]
Y	N	N	Y	N	V/f PGV/f SLV PGV PM SLV PM PGV TRQ 27 (1027): Universal DO [U-DO]
Y	Y	Y	Y	Y	V/f PGV/f SLV PGV PM SLV PM PGV TRQ 28 (1028): Heat sink overheat early warning [OH]

*101 Compatible with software version ROM0500 or later.

Function code and Name					Control method and Data setting range
E20 to E24, E27	E71	o01 to o07 *101	o23 to o26	o121 to o128	
Terminal [Y1] to [Y4], [Y5A/C], [30A/B/C]	Keypad M-LED indicator	Terminal [Y6A/C] to [Y12A/C] (for OPC-RY2)	Terminal [Y1A/B/C] to [Y4A/B/C] (for OPC-RY)	Terminal [01] to [08] (for OPC-DO)	
Y	Y	Y	Y	Y	V/f PGV/f SLV PGV PM SLV PM PGV TRQ 29 (1029): Master-follower operation complete [SY]
Y	Y	Y	Y	Y	V/f PGV/f SLV PGV PM SLV PM PGV TRQ 30 (1030): Lifetime alarm [LIFE]
Y	Y	Y	Y	Y	V/f PGV/f SLV PGV PM SLV PM PGV TRQ 31 (1031): Frequency (speed) detected 2 [FDT2]
Y	Y	Y	Y	Y	V/f PGV/f SLV PGV PM SLV PM PGV TRQ 33 (1033): Reference loss detected [REF OFF]
Y	Y	Y	Y	Y	V/f PGV/f SLV PGV PM SLV PM PGV TRQ 35 (1035): Inverter outputting [RUN2]
Y	Y	Y	Y	Y	V/f PGV/f SLV PGV PM SLV PM PGV TRQ 36 (1036): Overload prevention controlling [OLP]
Y	Y	Y	Y	Y	V/f PGV/f SLV PGV PM SLV PM PGV TRQ 37 (1037): Current detected [ID]
Y	Y	Y	Y	Y	V/f PGV/f SLV PGV PM SLV PM PGV TRQ 38 (1038): Current detected 2 [ID2]
Y	Y	Y	Y	Y	V/f PGV/f SLV PGV PM SLV PM PGV TRQ 39 (1039): Current detected 3 [ID3]
Y	Y	Y	Y	Y	V/f PGV/f SLV PGV PM SLV PM PGV TRQ 41 (1041): Low current detected [IDL]
Y	Y	Y	Y	Y	V/f PGV/f SLV PGV PM SLV PM PGV TRQ 42 (1042): PID alarm [PID-ALM]
Y	Y	Y	Y	Y	V/f PGV/f SLV PGV PM SLV PM PGV TRQ 43 (1043): Under PID control [PID-CTL]
Y	Y	Y	Y	Y	V/f PGV/f SLV PGV PM SLV PM PGV TRQ 44 (1044): Under sleep mode of PID control [PID-STP]
Y	Y	Y	Y	Y	V/f PGV/f SLV PGV PM SLV PM PGV TRQ 45 (1045): Low torque detected [U-TL]
Y	Y	Y	Y	Y	V/f PGV/f SLV PGV PM SLV PM PGV TRQ 46 (1046): Torque detected 1 [TD1]
Y	Y	Y	Y	Y	V/f PGV/f SLV PGV PM SLV PM PGV TRQ 47 (1047): Torque detected 2 [TD2]
Y	Y	Y	Y	Y	V/f PGV/f SLV PGV PM SLV PM PGV TRQ 48 (1048): Motor 1 selected [SWM1]
Y	Y	Y	Y	Y	V/f PGV/f SLV PGV PM SLV PM PGV TRQ 49 (1049): Motor 2 selected [SWM2]
Y	Y	Y	Y	Y	V/f PGV/f SLV PGV PM SLV PM PGV TRQ 50 (1050): Motor 3 selected [SWM3]
Y	Y	Y	Y	Y	V/f PGV/f SLV PGV PM SLV PM PGV TRQ 51 (1051): Motor 4 selected [SWM4]
Y	Y	Y	Y	Y	V/f PGV/f SLV PGV PM SLV PM PGV TRQ 52 (1052): Forward rotation [FRUN]
Y	Y	Y	Y	Y	V/f PGV/f SLV PGV PM SLV PM PGV TRQ 53 (1053): Reverse rotation [RRUN]
Y	Y	Y	Y	Y	V/f PGV/f SLV PGV PM SLV PM PGV TRQ 54 (1054): Under remote mode [RMT]
Y	Y	Y	Y	Y	V/f PGV/f SLV PGV PM SLV PM PGV TRQ 55 (1055): Drive command input available *100 [AX2]
Y	Y	Y	Y	Y	V/f PGV/f SLV PGV PM SLV PM PGV TRQ 56 (1056): Motor overheat detected by thermistor [THM]
Y	Y	Y	Y	Y	V/f PGV/f SLV PGV PM SLV PM PGV TRQ 57 (1057): Mechanical brake control [BRKS]
Y	Y	Y	Y	Y	V/f PGV/f SLV PGV PM SLV PM PGV TRQ 58 (1058): Frequency (speed) detected 3 [FDT3]
Y	Y	Y	Y	Y	V/f PGV/f SLV PGV PM SLV PM PGV TRQ 59 (1059): Current input wire break detection (terminal [C1] and [C2]) [C1OFF]
Y	Y	Y	Y	Y	V/f PGV/f SLV PGV PM SLV PM PGV TRQ 68 (1068): Fixed-time switching forecast signal *101 [MCHG]
Y	Y	Y	Y	Y	V/f PGV/f SLV PGV PM SLV PM PGV TRQ 69 (1069): Pump control output limit signal *101 [MLIM]
Y	Y	Y	Y	Y	V/f PGV/f SLV PGV PM SLV PM PGV TRQ 70 (1070): Speed valid [DNZS]
Y	Y	Y	Y	Y	V/f PGV/f SLV PGV PM SLV PM PGV TRQ 71 (1071): Speed agreement [DSAG]
Y	Y	Y	Y	Y	V/f PGV/f SLV PGV PM SLV PM PGV TRQ 72 (1072): Frequency (speed) arrival 3 [FAR3]
Y	Y	Y	Y	Y	V/f PGV/f SLV PGV PM SLV PM PGV TRQ 76 (1076): Speed mismatch [PG-ERR]
Y	Y	Y	Y	Y	V/f PGV/f SLV PGV PM SLV PM PGV TRQ 77 (1077): Low DC link bus voltage detection [U-EDC]

*100 Compatible with software version ROM0300 or later.
*101 Compatible with software version ROM0500 or later.

Function Codes

E codes :Extension Terminal Functions (terminal functions)

Table 2 Control input terminal setting table

Function code and Name					Control method and Data setting range
E20 to E24, E27	E71	o01 to o07 *101	o23 to o26	o121 to o128	
Terminal [Y1] to [Y4], [Y5A/C], [30A/B/C]	Keypad M-LED indicator	Terminal [Y6A/C] to [Y12A/C] (for OPC-RY2)	Terminal [Y1A/B/C] to [Y4A/B/C] (for OPC-RY)	Terminal [01] to [08] (for OPC-DO)	
Y	Y	Y	Y	Y	<input type="checkbox"/> V/f <input type="checkbox"/> PGV/f <input type="checkbox"/> SLV <input type="checkbox"/> PGV <input type="checkbox"/> PM SLV <input type="checkbox"/> PM PGV <input type="checkbox"/> TRQ 79 (1079): During decelerating at momentary power failure [IPF2]
Y	Y	Y	Y	Y	<input type="checkbox"/> V/f <input type="checkbox"/> PGV/f <input type="checkbox"/> SLV <input type="checkbox"/> PGV <input type="checkbox"/> PM SLV <input type="checkbox"/> PM PGV <input type="checkbox"/> TRQ 82 (1082): Positioning complete [PSET]
Y	Y	Y	Y	Y	<input type="checkbox"/> V/f <input type="checkbox"/> PGV/f <input type="checkbox"/> SLV <input type="checkbox"/> PGV <input type="checkbox"/> PM SLV <input type="checkbox"/> PM PGV <input type="checkbox"/> TRQ 84 (1084): Maintenance timer counted up [MNT]
Y	Y	Y	Y	Y	<input type="checkbox"/> V/f <input type="checkbox"/> PGV/f <input type="checkbox"/> SLV <input type="checkbox"/> PGV <input type="checkbox"/> PM SLV <input type="checkbox"/> PM PGV <input type="checkbox"/> TRQ 87 (1087): Frequency arrival and detected [FARFDT]
Y	N	Y	Y	Y	<input type="checkbox"/> V/f <input type="checkbox"/> PGV/f <input type="checkbox"/> SLV <input type="checkbox"/> PGV <input type="checkbox"/> PM SLV <input type="checkbox"/> PM PGV <input type="checkbox"/> TRQ 88 (1088): Auxiliary motor drive signal *101 [AUX_L]
Y	N	Y	Y	Y	<input type="checkbox"/> V/f <input type="checkbox"/> PGV/f <input type="checkbox"/> SLV <input type="checkbox"/> PGV <input type="checkbox"/> PM SLV <input type="checkbox"/> PM PGV <input type="checkbox"/> TRQ 90 (1090): Alarm content 1 [AL1]
					<input type="checkbox"/> V/f <input type="checkbox"/> PGV/f <input type="checkbox"/> SLV <input type="checkbox"/> PGV <input type="checkbox"/> PM SLV <input type="checkbox"/> PM PGV <input type="checkbox"/> TRQ 91 (1091): Alarm content 2 [AL2]
					<input type="checkbox"/> V/f <input type="checkbox"/> PGV/f <input type="checkbox"/> SLV <input type="checkbox"/> PGV <input type="checkbox"/> PM SLV <input type="checkbox"/> PM PGV <input type="checkbox"/> TRQ 92 (1092): Alarm content 4 [AL4]
					<input type="checkbox"/> V/f <input type="checkbox"/> PGV/f <input type="checkbox"/> SLV <input type="checkbox"/> PGV <input type="checkbox"/> PM SLV <input type="checkbox"/> PM PGV <input type="checkbox"/> TRQ 93 (1093): Alarm content 8 [AL8]
Y	Y	Y	Y	Y	<input type="checkbox"/> V/f <input type="checkbox"/> PGV/f <input type="checkbox"/> SLV <input type="checkbox"/> PGV <input type="checkbox"/> PM SLV <input type="checkbox"/> PM PGV <input type="checkbox"/> TRQ 95 (1095): Forced operation [FMRUN]
Y	Y	Y	Y	Y	<input type="checkbox"/> V/f <input type="checkbox"/> PGV/f <input type="checkbox"/> SLV <input type="checkbox"/> PGV <input type="checkbox"/> PM SLV <input type="checkbox"/> PM PGV <input type="checkbox"/> TRQ 98 (1098): Light alarm [L-ALM]
					<input type="checkbox"/> V/f <input type="checkbox"/> PGV/f <input type="checkbox"/> SLV <input type="checkbox"/> PGV <input type="checkbox"/> PM SLV <input type="checkbox"/> PM PGV <input type="checkbox"/> TRQ 99 (1099): Alarm output [ALM]
N	Y	Y	N	Y	<input type="checkbox"/> V/f <input type="checkbox"/> PGV/f <input type="checkbox"/> SLV <input type="checkbox"/> PGV <input type="checkbox"/> PM SLV <input type="checkbox"/> PM PGV <input type="checkbox"/> TRQ 100: No assignment [NONE]
Y	Y	Y	Y	Y	<input type="checkbox"/> V/f <input type="checkbox"/> PGV/f <input type="checkbox"/> SLV <input type="checkbox"/> PGV <input type="checkbox"/> PM SLV <input type="checkbox"/> PM PGV <input type="checkbox"/> TRQ 101 (1101): EN circuit failure detected [DECF]
					<input type="checkbox"/> V/f <input type="checkbox"/> PGV/f <input type="checkbox"/> SLV <input type="checkbox"/> PGV <input type="checkbox"/> PM SLV <input type="checkbox"/> PM PGV <input type="checkbox"/> TRQ 102 (1102): EN terminal input OFF [ENOFF]
Y	Y	Y	Y	Y	<input type="checkbox"/> V/f <input type="checkbox"/> PGV/f <input type="checkbox"/> SLV <input type="checkbox"/> PGV <input type="checkbox"/> PM SLV <input type="checkbox"/> PM PGV <input type="checkbox"/> TRQ 105 (1105): Braking transistor broken [DBAL]
Y	Y	Y	Y	Y	<input type="checkbox"/> V/f <input type="checkbox"/> PGV/f <input type="checkbox"/> SLV <input type="checkbox"/> PGV <input type="checkbox"/> PM SLV <input type="checkbox"/> PM PGV <input type="checkbox"/> TRQ 111 (1111) to 124(1124): Customizable logic output signal 1 to 14 [CLO1]~[CLO14]
Y	N	Y	Y	Y	<input type="checkbox"/> V/f <input type="checkbox"/> PGV/f <input type="checkbox"/> SLV <input type="checkbox"/> PGV <input type="checkbox"/> PM SLV <input type="checkbox"/> PM PGV <input type="checkbox"/> TRQ 125 (1125): Integral power pulse output [POUT]
Y	Y	Y	Y	Y	<input type="checkbox"/> V/f <input type="checkbox"/> PGV/f <input type="checkbox"/> SLV <input type="checkbox"/> PGV <input type="checkbox"/> PM SLV <input type="checkbox"/> PM PGV <input type="checkbox"/> TRQ 131 (1131): Speed limiting [S-LIM]
Y	Y	Y	Y	Y	<input type="checkbox"/> V/f <input type="checkbox"/> PGV/f <input type="checkbox"/> SLV <input type="checkbox"/> PGV <input type="checkbox"/> PM SLV <input type="checkbox"/> PM PGV <input type="checkbox"/> TRQ 132 (1132): Torque limit level [T-LIM]
Y	Y	Y	Y	Y	<input type="checkbox"/> V/f <input type="checkbox"/> PGV/f <input type="checkbox"/> SLV <input type="checkbox"/> PGV <input type="checkbox"/> PM SLV <input type="checkbox"/> PM PGV <input type="checkbox"/> TRQ 133 (1133): Low current detection [IDL2]
Y	Y	Y	Y	Y	<input type="checkbox"/> V/f <input type="checkbox"/> PGV/f <input type="checkbox"/> SLV <input type="checkbox"/> PGV <input type="checkbox"/> PM SLV <input type="checkbox"/> PM PGV <input type="checkbox"/> TRQ 135 (1135): Dancer upper limit position warning signal [D-UPFL]
					<input type="checkbox"/> V/f <input type="checkbox"/> PGV/f <input type="checkbox"/> SLV <input type="checkbox"/> PGV <input type="checkbox"/> PM SLV <input type="checkbox"/> PM PGV <input type="checkbox"/> TRQ 136 (1136): Dancer lower limit position warning signal [D-DNFL]
					<input type="checkbox"/> V/f <input type="checkbox"/> PGV/f <input type="checkbox"/> SLV <input type="checkbox"/> PGV <input type="checkbox"/> PM SLV <input type="checkbox"/> PM PGV <input type="checkbox"/> TRQ 137 (1137): Dancer position limit warning signal [D-FL]
Y	Y	Y	Y	Y	<input type="checkbox"/> V/f <input type="checkbox"/> PGV/f <input type="checkbox"/> SLV <input type="checkbox"/> PGV <input type="checkbox"/> PM SLV <input type="checkbox"/> PM PGV <input type="checkbox"/> TRQ 151 (1151): Overtravel detection [OT-OUT]
					<input type="checkbox"/> V/f <input type="checkbox"/> PGV/f <input type="checkbox"/> SLV <input type="checkbox"/> PGV <input type="checkbox"/> PM SLV <input type="checkbox"/> PM PGV <input type="checkbox"/> TRQ 152 (1152): Forced stop detection [STOP-OUT]
					<input type="checkbox"/> V/f <input type="checkbox"/> PGV/f <input type="checkbox"/> SLV <input type="checkbox"/> PGV <input type="checkbox"/> PM SLV <input type="checkbox"/> PM PGV <input type="checkbox"/> TRQ 153 (1153): Pass point detection 1 [PPAS1]
					<input type="checkbox"/> V/f <input type="checkbox"/> PGV/f <input type="checkbox"/> SLV <input type="checkbox"/> PGV <input type="checkbox"/> PM SLV <input type="checkbox"/> PM PGV <input type="checkbox"/> TRQ 154 (1154): Pass point detection 2 [PPAS2]
Y	Y	Y	Y	Y	<input type="checkbox"/> V/f <input type="checkbox"/> PGV/f <input type="checkbox"/> SLV <input type="checkbox"/> PGV <input type="checkbox"/> PM SLV <input type="checkbox"/> PM PGV <input type="checkbox"/> TRQ 158 (1158): Overload detected [LLIM]
					<input type="checkbox"/> V/f <input type="checkbox"/> PGV/f <input type="checkbox"/> SLV <input type="checkbox"/> PGV <input type="checkbox"/> PM SLV <input type="checkbox"/> PM PGV <input type="checkbox"/> TRQ 159 (1159): Performing light load automatic double speed operation [LAC]
Y	N	Y	Y	Y	<input type="checkbox"/> V/f <input type="checkbox"/> PGV/f <input type="checkbox"/> SLV <input type="checkbox"/> PGV <input type="checkbox"/> PM SLV <input type="checkbox"/> PM PGV <input type="checkbox"/> TRQ 160 (1160): Motor 1 inverter-driven *101 [M1_L]
					<input type="checkbox"/> V/f <input type="checkbox"/> PGV/f <input type="checkbox"/> SLV <input type="checkbox"/> PGV <input type="checkbox"/> PM SLV <input type="checkbox"/> PM PGV <input type="checkbox"/> TRQ 161 (1161): Motor 1 commercial power-driven *101 [M1_L]
					<input type="checkbox"/> V/f <input type="checkbox"/> PGV/f <input type="checkbox"/> SLV <input type="checkbox"/> PGV <input type="checkbox"/> PM SLV <input type="checkbox"/> PM PGV <input type="checkbox"/> TRQ 162 (1162): Motor 2 inverter-driven *101 [M2_L]
					<input type="checkbox"/> V/f <input type="checkbox"/> PGV/f <input type="checkbox"/> SLV <input type="checkbox"/> PGV <input type="checkbox"/> PM SLV <input type="checkbox"/> PM PGV <input type="checkbox"/> TRQ 163 (1163): Motor 2 commercial power-driven *101 [M2_L]
					<input type="checkbox"/> V/f <input type="checkbox"/> PGV/f <input type="checkbox"/> SLV <input type="checkbox"/> PGV <input type="checkbox"/> PM SLV <input type="checkbox"/> PM PGV <input type="checkbox"/> TRQ 164 (1164): Motor 3 inverter-driven *101 [M3_L]
					<input type="checkbox"/> V/f <input type="checkbox"/> PGV/f <input type="checkbox"/> SLV <input type="checkbox"/> PGV <input type="checkbox"/> PM SLV <input type="checkbox"/> PM PGV <input type="checkbox"/> TRQ 165 (1165): Motor 3 commercial power-driven *101 [M3_L]

*101 Compatible with software version ROM0500 or later.

Function code and Name					Control method and Data setting range
E20 to E24, E27	E71	o01 to o07 *101	o23 to o26	o121 to o128	
Terminal [Y1] to [Y4], [Y5A/C], [30A/B/C]	Keypad M-LED indicator	Terminal [Y6A/C] to [Y12A/C] (for OPC-RY2)	Terminal [Y1A/B/C] to [Y4A/B/C] (for OPC-RY)	Terminal [01] to [08] (for OPC-DO)	
Y	N	Y	Y	Y	V/f PGV/f SLV PGV PM SLV PM PGV TRQ 166 (1166): Motor 4 inverter-driven *101 [M4_L]
					167 (1167): Motor 4 commercial power-driven *101 [M4_L]
					169 (1169): Motor 5 commercial power-driven *101 [M5_L]
					171 (1171): Motor 6 commercial power-driven *101 [M6_L]
					173 (1173): Motor 7 commercial power-driven *101 [M7_L]
					175 (1175): Motor 8 commercial power-driven *101 [M8_L]
Y	Y	Y	Y	Y	V/f PGV/f SLV PGV PM SLV PM PGV TRQ 176 (1176): For manufacturer adjustment *101 [COM_ABN]
					177 (1177): For manufacturer adjustment *101 [COM_DO]
Y	Y	Y	Y	Y	V/f PGV/f SLV PGV PM SLV PM PGV TRQ 180 (1180): During rotary driving *101 [M-RUN]
					181 (1181): During rotary driven alarm *101 [M-ALM]
Y	Y	Y	Y	Y	V/f PGV/f SLV PGV PM SLV PM PGV TRQ 190 (1190): Scheduled driving *101 [TMD]
					191 (1191): Schedule 1 in operation *101 [TMD1]
					192 (1192): Schedule 2 in operation *101 [TMD2]
					193 (1193): Schedule 3 in operation *101 [TMD3]
					194 (1194): Schedule 4 in operation *101 [TMD4]
Y	Y	Y	Y	Y	V/f PGV/f SLV PGV PM SLV PM PGV TRQ 200 (1200): PID 2 selected *101 [PID2]
					201 (1201): PID 1 alarm *101 [PV1-ALM]
					202 (1202): PID 1 feedback error *101 [PV1-OFF]
					203 (1203): PID 2 alarm *101 [PV2-ALM]
					204 (1204): PID 2 feedback error *101 [PV2-OFF]
Y	Y	Y	Y	Y	V/f PGV/f SLV PGV PM SLV PM PGV TRQ 211 (1211): External PID 1 under control *101 [EPID1-CTL]
					212 (1212): External PID 1 output *101 [EPID1-OUT]
					213 (1213): External PID 1 during output *101 [EPID1-RUN]
					214 (1214): External PID 1 alarm *101 [EPV1-ALM]
					215 (1215): External PID 1 feedback error *101 [EPV1-OFF]
					221 (1221): External PID 2 under control *101 [EPID2-CTL]
					222 (1222): External PID 2 output *101 [EPID2-OUT]
					223 (1223): External PID 2 during output *101 [EPID2-RUN]
					224 (1224): External PID 2 alarm *101 [EPV2-ALM]
					225 (1225): External PID 2 feedback error *101 [EPV2-OFF]
					231 (1231): External PID 3 under control *101 [EPID3-CTL]
					232 (1232): External PID 3 output *101 [EPID3-OUT]
					233 (1233): External PID 3 during output *101 [EPID3-RUN]
					234 (1234): External PID 3 alarm *101 [EPV3-ALM]
					235 (1235): External PID 3 feedback error *101 [EPV3-OFF]
Y	Y	Y	Y	Y	V/f PGV/f SLV PGV PM SLV PM PGV TRQ 251 (1251): M/Shift key ON/OFF state [MTGL]

Note) () indicates logical inversion. (Short circuit - OFF)

*101 Compatible with software version ROM0500 or later.

Function Codes

E codes :Extension Terminal Functions (terminal functions)

Function code	Name	Control method and Data setting range	Change when running	Data copying
E29	Frequency arrival delay timer (FAR2)	V/f PGV/f SLV PGV PM SLV PM PGV TRQ 0.01 to 10.00s	Y	Y
E30	Frequency arrival detection width (Detection width)	V/f PGV/f SLV PGV PM SLV PM PGV TRQ 0.0 to 10.0Hz	Y	Y
E31	Frequency (operation level)	V/f PGV/f SLV PGV PM SLV PM PGV TRQ 0.0 to 599.0Hz	Y	Y
E32	detection 1 (Hysteresis width)		Y	Y
E34	Overload early warning/Current (Level)	V/f PGV/f SLV PGV PM SLV PM PGV TRQ 0.00 (Disable), 1 to 200% of inverter rated current(Inverter rated current dependent on F80)	Y	Y1 Y2
E35	detection (Timer)	0.01 to 600.00s	Y	Y
E36	Frequency detection 2 (Level)	V/f PGV/f SLV PGV PM SLV PM PGV TRQ 0.0 to 599.0Hz	Y	Y
E37	Current detection 2/ Low current (Level)	Same as E34	Y	Y1 Y2
E38	detection (Timer)	Same as E35	Y	Y
E39	Constant rate of feeding coefficient 1/ Speed display auxiliary coefficient 1	V/f PGV/f SLV PGV PM SLV PM PGV TRQ 0.000 to 9999	Y	Y
E42	LED display filter	V/f PGV/f SLV PGV PM SLV PM PGV TRQ 0.0 to 5.0s	Y	Y
E43	LED monitor (display selection)	V/f PGV/f SLV PGV PM SLV PM PGV TRQ 0: Speed monitor (Selectable with E48) 3: Output current 4: Output voltage when alarm occurred 8: Calculated motor output torque when alarm occurred 9: Power consumption 10: PID process command 12: PID feedback value 13: Timer value 14: PID output 15: Load factor 16: Motor output 17: Analog signal input monitor 21: Current position 22: Positioning deviation 23: Torque current (%) 24: Magnetic flux command(%) 25: Input watt-hour 26: Winding diameter 27: Position control start position 28: Stop target position 29: PID deviation 30: Torque bias 31: Estimated inertia acceleration/deceleration time conversion value (coming soon) 32: Customizable logic output 50: PID command value (Final) *101 51: PID feedback value (Final) *101 52: PID output *101 53: PID control 1 command value *101 54: PID control 1 feedback value *101 55: PID control 2 command value *101 56: PID control 2 feedback value *101 60: External PID control 1 command value (Final) *101 61: External PID control 1 feedback value (Final) *101 62: External PID control 1 output (%) *101 63: External PID control 1 manual command value (%) *101 64: External PID control 1 command value *101 65: External PID control 1 feedback value *101 70: External PID control 2 command value *101 71: External PID control 2 feedback value *101 72: External PID control 2 output (%) *101 73: External PID control 2 manual command value (%) *101 80: External PID control 3 command value *101 81: External PID control 3 feedback value *101 82: External PID control 3 output (%) *101 83: External PID control 3 manual command value (%) *101	Y	Y
E44	(Display when stopped)	0: Specified value 1: Output value	Y	Y
E48	LED monitor details (Speed monitor selection)	V/f PGV/f SLV PGV PM SLV PM PGV TRQ 0: Output frequency 1 (before slip compensation) 1: Output frequency 2 (after slip compensation) 2: Set frequency	Y	Y

*3 The rated current of the motor is set. For details, refer to the FRENIC-MEGA (G2) User's Manual.

*101 Compatible with software version ROM0500 or later.

Function code	Name	Control method and Data setting range	Change when running	Data copying
E48	LED monitor details (Speed monitor selection)	<p>V/f PGV/f SLV PGV PM SLV PM PGV TRQ</p> <p>3: Motor speed 4: Feed speed 5: Line speed 6: Constant feeding rate time 7: Speed (%) 8: Reference line speed 9: Line speed output value</p>	Y	Y
E49	Torque Command Monitor (Polarity selection)	<p>V/f PGV/f SLV PGV PM SLV PM PGV TRQ</p> <p>0: Torque polarity 1: Plus for driving, Minus for braking</p>	Y	Y
E50	Display coefficient for speed monitor	<p>V/f PGV/f SLV PGV PM SLV PM PGV TRQ</p> <p>0.01 to 600.00</p>	Y	Y
E51	Display coefficient for "Input watt-hour data"	<p>V/f PGV/f SLV PGV PM SLV PM PGV TRQ</p> <p>0.000 (Cancel/Reset), 0.001 to 9999</p>	Y	Y
E52	Keypad menu selection	<p>V/f PGV/f SLV PGV PM SLV PM PGV TRQ</p> <p>0: Function code data setting mode (Menu 0, Menu 1, and Menu 7) 1: Function code data check mode (Menu 2 and Menu 7) 2: Full-menu mode</p>	Y	Y
E54	Frequency detection 3 (Level)	<p>V/f PGV/f SLV PGV PM SLV PM PGV TRQ</p> <p>0.0 to 599.0Hz</p>	Y	Y
E55	Current detection 3 (Level)	Same as E34	Y	Y1 Y2
E56	(Timer)	Same as E35	Y	Y
E57	Integral power pulse output unit	<p>V/f PGV/f SLV PGV PM SLV PM PGV TRQ</p> <p>0: Pulse output every 0.1 kWh 1: Pulse output every 1 kWh 2: Pulse output every 10 kWh 3: Pulse output every 100 kWh 4: Pulse output every 1000 kWh</p>	Y	Y
E61	Terminal [12] (extended function)	<p>V/f PGV/f SLV PGV PM SLV PM PGV TRQ</p>	N	Y
E62	Terminal [C1] (C1 function) (extended function)	<p>0: No extension function assignment 1: Auxiliary frequency setting 1 2: Auxiliary frequency setting 2</p>	N	Y
E63	Terminal [V2] (extended function)	<p>3: PID command 1 4: PID command 2 *101 5: PID Dfeedback value 6: Ratio setting 7: Analog torque limiter A 8: Analog torque limit value B 9: Torque bias 10: Torque command 11: Torque current command 12: Acceleration/deceleration time ratio setting 13: Upper limit frequency 14: Lower limit frequency 15: Auxiliary frequency setting 3 16: Auxiliary frequency setting 4 17: Speed limit for forward rotation (FWD) 18: Speed limit for reverse rotation (REV) 19: For manufacturer adjustment *101 20: Analog signal input monitor 30: PID feedback value 2 *101 31: PID process command auxiliary setting 1 *101 32: PID process command auxiliary setting 2 *101 33: Flow sensor *101 41: External PID process command 1 *101 42: External PID feedback value 1 *101 43: External PID manual command 1 *101 44: External PID process command 2 *101 45: External PID feedback value 2 *101 46: External PID manual command 2 *101 47: External PID process command 3 *101 48: External PID feedback value 3 *101 49: External PID manual command 3 *101</p>	N	Y
E64	Saving of digital reference frequency	<p>V/f PGV/f SLV PGV PM SLV PM PGV TRQ</p> <p>0: Auto saving (main power is turned off) 1: Save by turning  key ON</p>	Y	Y

*3 The rated current of the motor is set. For details, refer to the FRENIC-MEGA (G2) User's Manual.
*101 Compatible with software version ROM0500 or later.

Features
Main application examples
Model variations
Type number nomenclature
Standard specifications
Common specifications
Terminal specifications
Basic wiring diagram
External dimensions
Keypad
Function codes
Options
Product warranty





Function Codes

E codes :Extension Terminal Functions (terminal functions)

Function code	Name	Control method and Data setting range	Change when running	Data copying
E65	Reference loss detection (Continuous running frequency)	V/f PGV/f SLV PGV PM SLV PM PGV TRQ 0: Stop deceleration 20 to 120%, 999: Cancel	Y	Y
E66	Terminal [C1] (V3 function) (Extension function selection)	Same as E61	N	Y
E70	M/Shift key (Function selection)	Table 1 Refer to E70 in the control input terminal setting table.	N	Y
E71	M-LED indicator (Function selection)	Table 2 Refer to E71 in the control input terminal setting table.	N	Y
E76	DC link bus low-voltage detection level	V/f PGV/f SLV PGV PM SLV PM PGV TRQ 200 to 400 V (200 V series) 400 to 800 V (400 V series)	Y	Y2
E78	Torque detection 1 (Level)	V/f PGV/f SLV PGV PM SLV PM PGV TRQ 0 to 300%	Y	Y
E79	(Timer)	0.01 to 600.00s	Y	Y
E80	Torque detection 2/ low torque detection (Level)	Same as E78	Y	Y
E81	(Timer)	Same as E79	Y	Y
E82	Acceleration/deceleration time switching frequency *101	V/f PGV/f SLV PGV PM SLV PM PGV TRQ 0.0 (Inherit): According to the F16 setting 0.1 to 599.0 Hz	Y	Y
E83	Acceleration time (At low speeds) *101	0.00 (Inherit): According to the acceleration time currently in effect 0.01 to 6000: Acceleration time between 0 Hz to E82	Y	Y
E84	Deceleration time (At low speeds) *101	0.00 (Inherit): According to the deceleration time currently in effect 0.01 to 6000: Deceleration time between E82 to 0 Hz	Y	Y
E85	Slow deceleration time switching frequency *101	0.0 (OFF): Inoperative 0.1 to 599.0 Hz	Y	Y
E86	Slow (Check valve protection) deceleration time *101	0.00 (Inherit): According to the deceleration time currently in effect 0.01 to 6000: Deceleration time between F16 to E85	Y	Y
E98	Terminal [FWD] (Function selection)	Table 1 Refer to E98 and E99 in the control input terminal setting table.	N	Y
E99	Terminal [REV] (Function selection)		N	Y

*101 Compatible with software version ROM0500 or later.

C codes :Control Functions of Frequency (Control function)

Function code	Name	Control method and Data setting range	Change when running	Data copying
C01	Jump frequency 1	V/f PGV/f SLV PGV PM SLV PM PGV TRQ	Y	Y
C02	2	0.0 to 599.0Hz	Y	Y
C03	3		Y	Y
C04	(Skip width)	0.0 to 30.0Hz	Y	Y
C05	Multistep frequency 1	V/f PGV/f SLV PGV PM SLV PM PGV TRQ	Y	Y
C06	2	0.00 to 599.00Hz	Y	Y
C07	3		Y	Y
C08	4		Y	Y
C09	5		Y	Y
C10	6		Y	Y
C11	7		Y	Y
C12	8		Y	Y
C13	9		Y	Y
C14	10		Y	Y
C15	11		Y	Y
C16	12		Y	Y
C17	13		Y	Y
C18	14		Y	Y
C19	15		Y	Y
C20	Jogging frequency	V/f PGV/f SLV PGV PM SLV PM PGV TRQ 0.00 to 599.00Hz	Y	Y
C21	Pattern operation / timed operation (Operation selection)	V/f PGV/f SLV PGV PM SLV PM PGV TRQ 0: cycle operation 1: Repetition operation 2: Constant speed operation after 1 cycle operation 3: Timed operation	N	Y
C22	(Stage 1)		Y	Y
C23	(Stage 2)	Special setting: Press the key 3  times.	Y	Y
C24	(Stage 3)	1st: Set run time 0.0 to 6000 s and press the  key.	Y	Y
C25	(Stage 4)	2nd: Set rotational direction F (forward) or r (reverse) and press the  key.	Y	Y
C26	(Stage 5)	3rd: Set acceleration/deceleration time 1 to 4 and press the  key.	Y	Y
C27	(Stage 6)		Y	Y
C28	(Stage 7)		Y	Y
C30	Frequency setting 2	Same as F01	N	Y
C31	Analog input adjustment (Terminal [12])	V/f PGV/f SLV PGV PM SLV PM PGV TRQ -5.0 to 5.0%	Y*	Y
C32	(Gain)	0.00 to 400.00%	Y*	Y
C33	(Filter)	0.00 to 5.00s	Y	Y
C34	(Gain base point)	0.00 to 100.00%	Y*	Y
C35	(polarity selection)	0: Bipolar 1: Unipolar	N	Y
C36	Analog input adjustment (Terminal [C1])	Same as C31	Y*	Y
C37	(C1 function) (Offset)			
C38	(Gain)	Same as C32	Y*	Y
C39	(Filter)	Same as C33	Y	Y
C40	(Gain base point)	Same as C34	Y*	Y
C41	(polarity selection)	0: 4 to 20 mA Unipolar 1: 0 to 20 mA Unipolar 10: 4 to 20 mA Bipolar 11: 0 to 20 mA Bipolar	N	Y
C42	Analog input adjustment (Terminal [V2])	Same as C31	Y*	Y
C43	(Offset)			
C44	(Gain)	Same as C32	Y*	Y
C45	(Filter)	Same as C33	Y	Y
C46	(Gain base point)	Same as C34	Y*	Y
C47	(polarity selection)	Same as C35	N	Y
C50	Bias (for frequency setting 1) (Bias base point)	V/f PGV/f SLV PGV PM SLV PM PGV TRQ 0.00 to 100.00%	Y*	Y
C51	Bias (PID command 1) (bias value)	V/f PGV/f SLV PGV PM SLV PM PGV TRQ -100.0 to 0.00~100.00%	Y*	Y
C52	(Bias base point)	0.00 to 100.00%	Y*	Y
C53	Selection of normal/ (Frequency setting 1) inverse operation (Frequency setting 2)	V/f PGV/f SLV PGV PM SLV PM PGV TRQ 0: Normal 1: Inverse	Y	Y
C54			Y	Y

Function Codes

C codes :Control Functions of Frequency (Control function)

Function code	Name	Control method and Data setting range	Change when running	Data copying
C55	Analog input adjustment (Terminal [12]) (Bias)	<div style="display: flex; justify-content: space-between; align-items: center;"> V/f PGV/f SLV PGV PM SLV PM PGV TRQ </div> -200.0 to 0.00 to 200.00%	Y*	Y
C56	(Bias base point)	0.00 to 100.00%	Y*	Y
C58	(Display unit)	1 to 92 1: No unit 2: % 4: r/min 7: kW 8: HP 10: mm/s 11: mm/m 12: mm/h 13: m/s 14: m/min 15: m/h 16: FPS 17: FPM 18: FPH 19: SPM (ROM0300 or later) [flow] 20: m3/s 21: m3/min 22: m3/h 23: L/s 24: L/min 25: L/h 26: GPS 27: GPM 28: GPH 29: CFS 30: CFM 31: CFH 32: kg/s 33: kg/m 34: kg/h 35: lb/s 36: lb/m 37: lb/h 38: AF/Y [Pressure] 40: Pa 41: kPa 42: MPa 43: mbar 44: bar 45: mmHg 46: PSI 47: mWG 48: inWG 49: inHg 50: WC 51: Ft WG 52: ATM (ROM0300 or later) [Temperature] 60: K 61: °C 62: °F [Distance] 65: Nm 66: lb Ft 70: mm 71: cm 72: m 73: km 74: in 75: Ft 76: Yd 77: mi [Concentration] 80: ppm [Others] 90 : m3 91 : L 92 : GAL 93 : OZ (ROM0300 or later)	Y	Y

Function code	Name	Control method and Data setting range	Change when running	Data copying
C59	Analog input adjustment (Terminal [12]) (maximum scale)	<input type="checkbox"/> V/f <input type="checkbox"/> PGV/f <input type="checkbox"/> SLV <input type="checkbox"/> PGV <input type="checkbox"/> PM SLV <input type="checkbox"/> PM PGV <input type="checkbox"/> TRQ -999.0 to 0.00 to 9990.0	N	Y
C60	(minimum scale)	-999.0 to 0.00 to 9990.0	N	Y
C61	Analog input adjustment (Terminal [C1] (C1 function)) (Bias)	<input type="checkbox"/> V/f <input type="checkbox"/> PGV/f <input type="checkbox"/> SLV <input type="checkbox"/> PGV <input type="checkbox"/> PM SLV <input type="checkbox"/> PM PGV <input type="checkbox"/> TRQ -200.0 to 0.00 to 200.00%	Y*	Y
C62	(Bias base point)	0.00 to 100.00%	Y*	Y
C64	(Display unit)	Same as C58	Y	Y
C65	(maximum scale)	-999.0 to 0.00 to 9990.0	N	Y
C66	(minimum scale)	-999.0 to 0.00 to 9990.0	N	Y
C67	Analog input adjustment (Terminal [V2]) (Bias)	<input type="checkbox"/> V/f <input type="checkbox"/> PGV/f <input type="checkbox"/> SLV <input type="checkbox"/> PGV <input type="checkbox"/> PM SLV <input type="checkbox"/> PM PGV <input type="checkbox"/> TRQ -200.0 to 0.00 to 200.00%	Y*	Y
C68	(Bias base point)	0.00 to 100.00%	Y*	Y
C70	(Display unit)	Same as C58	Y	Y
C71	(maximum scale)	-999.0 to 0.00 to 9990.0	N	Y
C72	(minimum scale)	-999.0 to 0.00 to 9990.0	N	Y
C74	Analog input adjustment (Terminal [C1]) (V3 function) (offset)	<input type="checkbox"/> V/f <input type="checkbox"/> PGV/f <input type="checkbox"/> SLV <input type="checkbox"/> PGV <input type="checkbox"/> PM SLV <input type="checkbox"/> PM PGV <input type="checkbox"/> TRQ -5.0 to 5.0%	Y*	Y
C75	(Gain)	0.00 to 400.00%	Y*	Y
C76	(Filter)	0.00 to 5.00s	Y	Y
C77	(Gain base point)	0.00 to 100.00%	Y*	Y
C78	(polarity selection)	0: Bipolar 1: Unipolar	N	Y
C82	(Bias)	-200.0 to 0.00 to 200.00%	Y*	Y
C83	(Bias base point)	0.00 to 100.00%	Y*	Y
C84	(Display unit)	Same as C58	Y	Y
C85	(maximum scale)	-999.0 to 0.00 to 9990.0	N	Y
C86	(minimum scale)	-999.0 to 0.00 to 9990.0	N	Y
C89	Frequency compensation 1 via communication (Numerator)	<input type="checkbox"/> V/f <input type="checkbox"/> PGV/f <input type="checkbox"/> SLV <input type="checkbox"/> PGV <input type="checkbox"/> PM SLV <input type="checkbox"/> PM PGV <input type="checkbox"/> TRQ -32768 to 32767	Y	Y
C90	Frequency compensation 2 via communication (Denominator)	(Keypad display is 8000 to 7FFF (in hexadecimal)) (Interpreted as 1 when the value is set to 0)	Y	Y
C94	Jump frequency 4	<input type="checkbox"/> V/f <input type="checkbox"/> PGV/f <input type="checkbox"/> SLV <input type="checkbox"/> PGV <input type="checkbox"/> PM SLV <input type="checkbox"/> PM PGV <input type="checkbox"/> TRQ	Y	Y
C95	5	0.0 to 599.0Hz	Y	Y
C96	6		Y	Y
C99	Digital setting frequency	<input type="checkbox"/> V/f <input type="checkbox"/> PGV/f <input type="checkbox"/> SLV <input type="checkbox"/> PGV <input type="checkbox"/> PM SLV <input type="checkbox"/> PM PGV <input type="checkbox"/> TRQ 0.00 to maximum output frequency (1 to 4)	Y*	Y

- Features
- Main application examples
- Model variations
- Type number nomenclature
- Standard specifications
- Common specifications
- Terminal specifications
- Basic wiring diagram
- External dimensions
- Keypad
- Function codes
- Options
- Product warranty

Options

Connection configuration

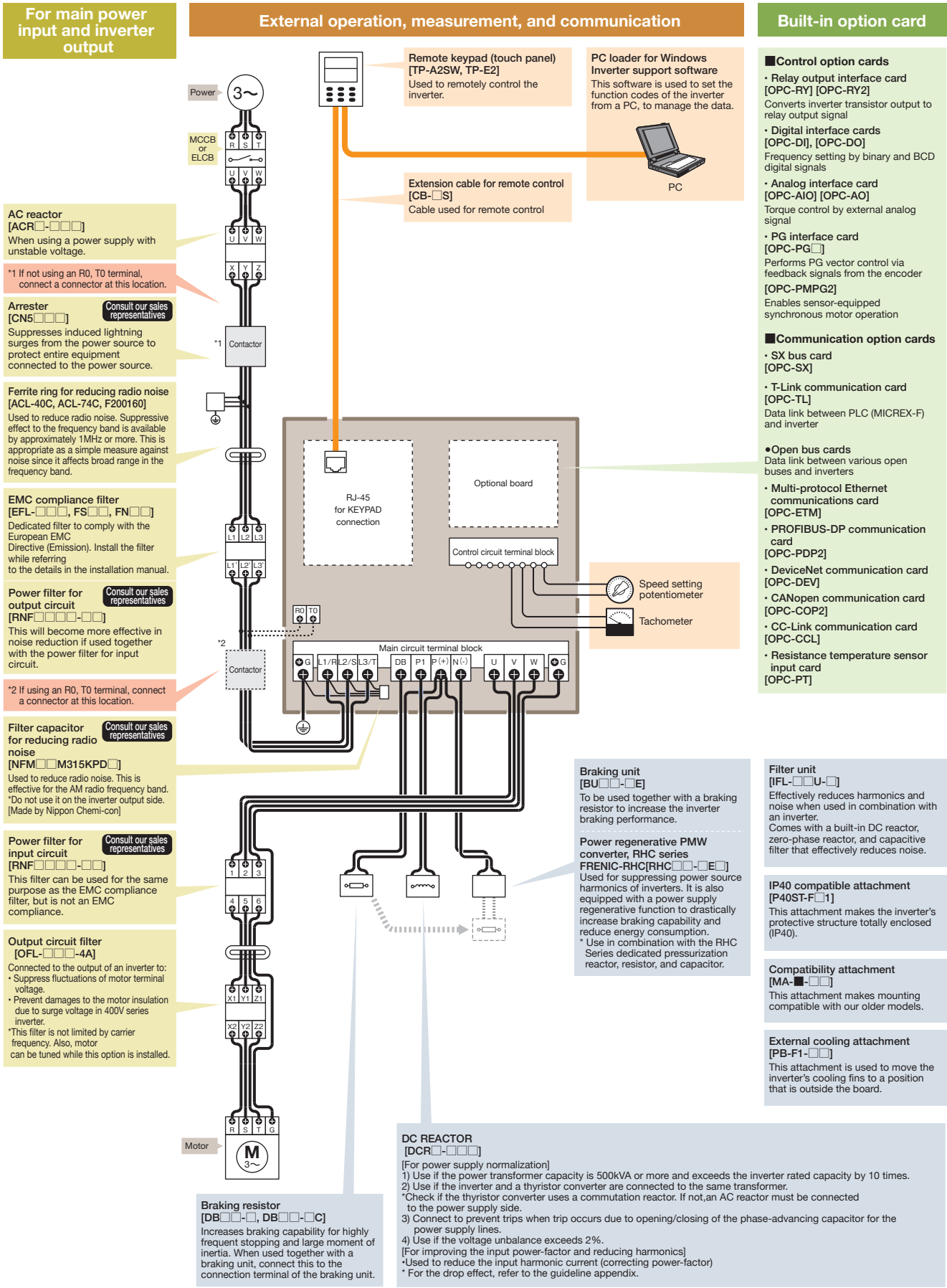

Peripheral and structure options

Multifunction keypad [TP-A2SW]



- Equipped with a highly visible LCD.
- Supports a total of 19 languages, including Japanese hiragana, katakana and kanji.
- Parameter changes and maintenance can be performed remotely using a mobile device built-in bluetooth.

Item	Specification	Remarks
Supported languages	Supports a total of 19 languages, including Japanese, English and Chinese.	
Copy function	Three sets can be stored.	
USB port	Type: mini B	FRENIC Loader for Windows OS
Wireless communication network	Bluetooth Ver.5.0	FRENIC Mobile Loader for Android OS
micro SD card*	SDHC standards (max 32GB)	
Battery*	CR2032	Trace back function
Extension cable	ANSI/TIA/EIA568A Category 5 (10BASE-T/100BASE-TX)	Real-time clock function
Connector for keypad	RJ-45	Option type: CB-□S
Enclosure	Outside cabinet: IP55, inverter back side: IP20	
Approx. weight	135 g	

*SD card not included.

Extension cable for remote control [CB-□S]



This straight cable is used to connect the RJ-45 connector of the inverter body to the keypad, USB-RS485 converter, etc. Available in three lengths (1, 3, 5m).

- Cable

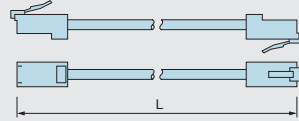

Type	CB-5S	CB-3S	CB-1S
Length [m]	5	3	1

IP40 compatible attachment [P40ST-F□1]

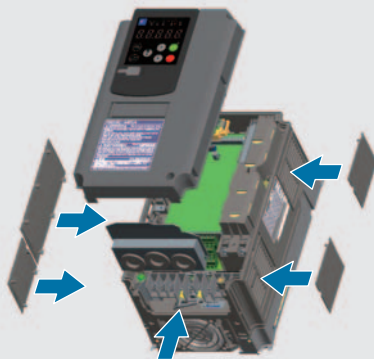

By mounting this product to the body of the standard type (basic type), the protective structure can be changed from IP20 (standard enclosed type) to IP40 (totally enclosed type).

Applicable list table

Item	Specification											
	P40ST-FA1		P40ST-FB1			P40ST-FC1			P40ST-FD1			
Applicable inverter type FRN□□□□G2S-4G	0002	0003	0004	0006	0009	0018	0023	0031	0038	0045	0060	
FRN□□□□G2S-2G	0003	0005	0008	0011	0018	0032	0046	0059	0075	0088	0115	
Approx. weight [kg]	0.1		0.2			0.3			0.4			

Configuration kit

Type	Remarks				
P40ST-FA1	Closing plate (small side) x 3 pcs.	Closing plate (large side) x 1 pc.	Wiring cover x 1 pc.		
P40ST-FB1	Closing plate (small side) x 3 pcs.	Closing plate (large side) x 1 pc.	Wiring cover x 1 pc.		
P40ST-FC1	Closing plate (small side) x 3 pcs.	Closing plate (large side) x 1 pc.	Closing plate (right corner) x 1 pc. (left corner) x 1 pc.	Wiring cover x 1 pc.	Cross-recessed pan head screw with built-in washer x 2 pcs. (M5 x 10)
P40ST-FD1	Closing plate (small side) x 3 pcs.	Closing plate (large side) x 2 pcs.	Closing plate (right corner) x 1 pc. (left corner) x 1 pc.	Wiring cover x 1 pc.	Cross-recessed pan head screw with built-in washer x 2 pcs. (M5 x 10)

Note 1 Can be mounted only on the standard type (basic type).

Note 2 Ambient temperature: -10 to +40°C

Note 3 When attaching the IP40 option, only one optional card can be mounted (two OPC-RY cards can be mounted).

Note 4 After attaching the IP40 option, change the setting with bit 7 (IP20 / IP40 switching) of the function code H98 (protection / operation selection).

External cooling attachment [PB-F1-□□]

This attachment is used to move the inverter's cooling fins to a position that is outside the board.

■ PB-F1-15

(unit: mm)

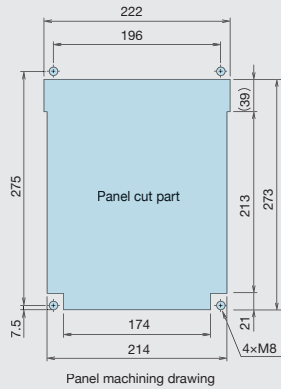
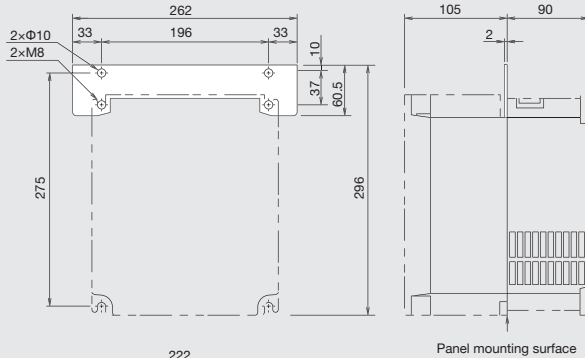

Applicable inverter type	
FRN0018G2	■-4G
FRN0023G2	■-4G
FRN0031G2	■-4G
FRN0032G2S	-2G
FRN0046G2S	-2G
FRN0059G2S	-2G

■ PB-F1-30

(unit: mm)

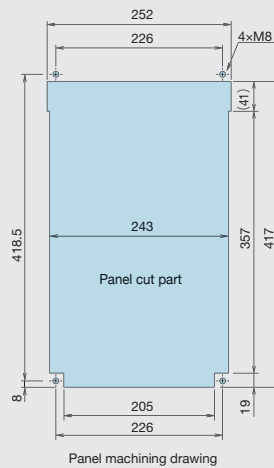
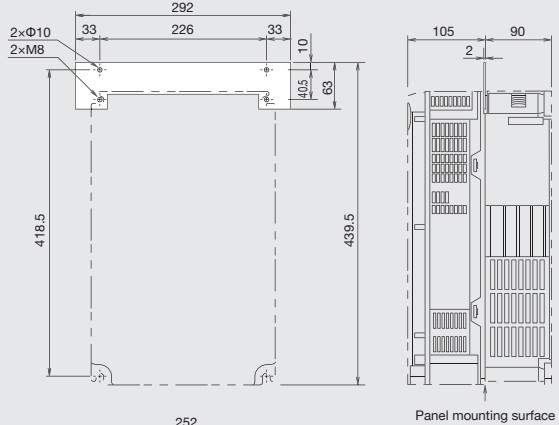

Applicable inverter type	
FRN0038G2	■-4G
FRN0045G2	■-4G
FRN0060G2	■-4G
FRN0075G2S	-2G
FRN0088G2S	-2G
FRN0115G2S	-2G

Control terminal block [OPC-G1-TB1]

A round terminal blocks can be connected. Compatible with the conventional FRENIC-MEGA_G1 series.



■ Specification of the screw and the torque and recommended wire size

Common terminal	Specification of the screw		Recommended wire size (mm ²)
	Screw size	Tightening torque (N·m)	
Control circuit terminal	M3	0.7	0.75 *
fixation screw	M3	0.7	—

* When attaching the terminal block, can not use the function of the terminal [X6], [EN1], [EN2] and [FM2].
If using the terminal [X6] in FRENIC-MEGA_G1 series, assign it to other than terminal [X6].

Built-in option card

Item	Type	Specification
PG interface card	OPC-PG	Comes with a two-system pulse input circuit, enabling speed control, position control, and synchronous operation. <ul style="list-style-type: none"> Applications: Speed control (vector control with sensor) pulse train input Specifications: 20 to 3000 P/R A, B, Z phase (incremental) Open collector/complimentary system PG power supply: +12 Vdc ±10% / 120 mA or less or +15 Vdc ±10% / 120 mA or less
PG interface (5 V line driver) card	OPC-PG2	Comes with a single-system pulse input circuit, enabling speed control (vector control with sensor) with PG-based feedback signals. <ul style="list-style-type: none"> Applications: Speed control (vector control with sensor) Specifications: 20 to 3000 P/R 5 V line driver system (single system) PG power supply: +5 VDC ±10% / 200 mA or less
PG interface (5 V line driver x 2 systems) card	OPC-PG22	Comes with two 5 V line driver pulse input circuits, enabling synchronous operation, positioning control and vibration control of two PG-equipped motors using PG-based feedback signals, as well as frequency command using pulse train input. <ul style="list-style-type: none"> Applications: Speed control (vector control with sensor, V/f control with sensor, dynamic torque vector control with sensor), pulse train input, synchronous operation, positioning control Specifications: 20 to 3000 P/R, 5 V line driver system (two systems) PG power supply: +5 VDC ±10% / 300 mA or less
PG interface card for synchronous motor drive	OPC-PMPG2	Comes with a 5 V line driver single-system pulse input circuit, enabling synchronous motor operation (vector control with synchronous motor sensor) with PG-based feedback signals. <ul style="list-style-type: none"> Applications: Synchronous motor operation (vector control with sensor) Specifications: 20 to 3000 P/R 5 V line driver system PG power supply: +5 VDC ±10% / 300 mA or less
Relay output interface card	OPC-RY	This is an option card for converting the transistor outputs of terminals Y1 to Y4 of the inverter into relay outputs (1C contact). Comes with 2 relay outputs, but supports 4 relay outputs when 2 interface cards are installed. <ul style="list-style-type: none"> Relay output: 2 circuits built-in Signal type: 1 contact Contact capacity: 250 VAC 0.3 A cosφ = 0.3, 48 VDC, 0.5 A (resistive load)
	OPC-RY2	Any output signal (up to 7 types) set by a function code can be output via relay output (1a contact). <ul style="list-style-type: none"> Relay output: Up to 7 circuits Signal type: 1a contact Contact capacity: 250 V AC 0.3 A, cos φ = 0.3, 48 V DC 0.5 A (Resistance load)
Relay output interface card	OPC-RY	Any output signal (up to 7 types) set by a function code can be output via relay output (1a contact). <ul style="list-style-type: none"> Relay output: Up to 7 circuits Signal type: 1a contact Contact capacity: 250 V AC 0.3 A, cos φ = 0.3, 48 V DC 0.5 A (Resistance load)
Digital interface card	OPC-DI	16 digital input terminals (sink/source switchable) Enables frequency setting by binary code (8, 12, 15, or 16 bits) and BCD code, and expansion of general-purpose input terminals.
	OPC-DO	8 digital output terminals (sink/source switchable) Enables monitoring by binary code (8 bits) and expansion of general-purpose output terminals.
Analog interface card	OPC-AIO	Enables torque limit value, frequency setting, and ratio tuning setting via analog input. Enables monitoring of inverter output frequency, current, torque, etc. in analog quantities. <ul style="list-style-type: none"> Analog input <ul style="list-style-type: none"> Analog voltage input: 1 (0 to ±10 V) Analog current input: 1 (4 to 20 mA or 0 to 20 mA) Analog output <ul style="list-style-type: none"> Analog voltage output: 1 (0 to ±10 V) Analog current output: 1 (4 to 20 mA)
Analog current output (2 ch) interface card	OPC-AO	Enables monitoring of inverter output frequency, current, torque, etc. in analog units. 2 analog current outputs (4 to 20 mA)
Multi-protocol Ethernet communication card	OPC-ETM	Connects to the master device via Ethernet communication (EtherNet/IP, PROFINET), enabling setting of operation commands and frequency commands, and setting and checking of function codes. <ul style="list-style-type: none"> Connector type: RJ-45 shielded Ethernet cable: CAT-5e or higher UTP or STP cable Physical layer type: IEEE 802.3 No. of ports: 2-port (with built-in switch function) Communication speed: 10 Mbps/100 Mbps (auto detection)
DeviceNet communication card	OPC-DEV	Operation and frequency commands can be set from DeviceNet master, enabling monitoring of operation status and changing/checking of all function codes <ul style="list-style-type: none"> No. of connected nodes: Up to 64 (including master) MAC ID: 0 to 63 Insulation: 500 VDC (photocoupler insulation) Communication speed: 500 kbps/250 kbps/125 kbps Network power consumption: Up to 80 mA 24 VDC
PROFIBUS-DP communication card	OPC-PDP2	Operation and frequency commands can be set from PROFIBUS-DP master, enabling monitoring of operation status and changing/checking of all function codes. <ul style="list-style-type: none"> Communication speed: 9.6 kbps to 12 Mbps Transmission distance: Up to 1,200 m Connection connector: 2 x 6-pole terminal block
CC-Link communication card	OPC-CCL	When connecting to a CC-Link master unit, it supports a communication speed of up to 10 Mbps and a total length of up to 1,200 m. <ul style="list-style-type: none"> No. of connected units: 42 Communication method: CC-Link Ver1.10 and Ver2.0 Communication speed: 156 kbps or faster
Resistance temperature sensor input card	OPC-PT	Enables conversion of temperature values to digital values. Enables connection of two resistance temperature detectors (RTDs). There are five types of connectible resistance temperature detectors (RTDs): "JPT100", "Pt100", "Ni100", "Pt1000", and "Ni1000".
SX bus communication card	OPC-SX	This is an option to connect our PLCs (MICREX-SX Series) and inverters via SX bus. Allows for the following: <ul style="list-style-type: none"> No. of transmission words occupied: 16 words Maximum transmission speed: 25 Mbps Setting of operating frequency Setting of operation commands (FWD, REV, RST, etc.) Operation status monitor Set/read data code for each function code
T-Link communication card	OPC-TL	This is an option to connect our PLCs (MICREX-SX, MICREX-F) and inverters via T-link (I/O transmission). Allows for the following: <ul style="list-style-type: none"> No. of transmission words occupied: 8 words No. of connected inverters: Up to 12 Maximum transmission speed: 500 kbps Setting of operating frequency Setting of operation commands (FWD, REV, RST, etc.) Operation status monitor Set/read data code for each function code
CANopen communication card	OPC-COP2	Operation and frequency commands can be set from CANopen master (PC, PLC, etc.), as well as setting/checking of all function codes. <ul style="list-style-type: none"> No. of connected nodes: Up to 127 Communication speed: 20 kbps, 50 kbps, 125 kbps, 250 kbps, 500 kbps, 800 kbps, 1 Mbps Transmission distance: Up to 2,500 m

AC Reactor
[Standard specifications]
[DB□□ - □]

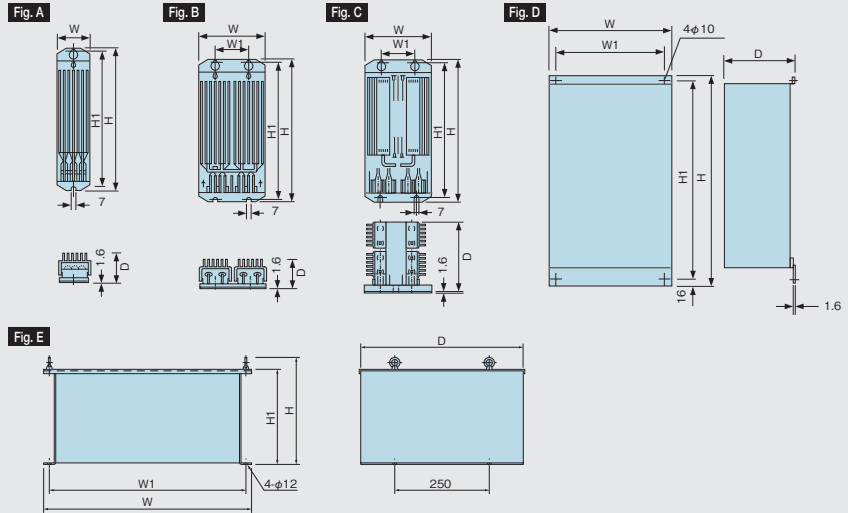
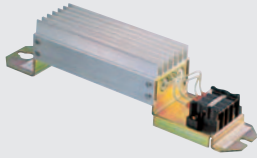

Voltage	Type	Fig	Dimensions [mm]					Approx. weight [kg]
			W	W1	H	H1	D	
3-phase 200V	DB0.75-2	A	68	—	310	295	67	1.3
	DB2.2-2		80	—	345	332	94	2
	DB3.7-2		80	—	345	332	94	2
	DB5.5-2	B	146	90	450	430	67.5	4.5
	DB7.5-2		160	90	390	370	90	5
	DB11-2	C	142	74	430	415	160	6.9
	DB15-2		142	74	430	415	160	6.9
	DB18.5-2		142	74	510	495	160	8.7
	DB22-2	D	142	74	510	495	160	8.7
	DB30-2C		400	368	660	628	140	10
	DB37-2C						13	
	DB45-2C						18	
	DB55-2C	22						
	DB75-2C	E	450	420	283	240	440	35
DB110-2C	550		520	32				

Voltage	Type	Fig	Dimensions [mm]					Approx. weight [kg]
			W	W1	H	H1	D	
3-phase 400V	DB0.75-4	A	68	—	310	295	67	1.3
	DB2.2-4		68	—	470	455	67	2
	DB3.7-4		68	—	470	455	67	1.7
	DB5.5-4	B	146	74	470	455	67	4.5
	DB7.5-4		146	74	510	495	67	5
	DB11-4	C	142	74	430	415	160	6.9
	DB15-4		142	74	430	415	160	6.9
	DB18.5-4		142	74	510	495	160	8.7
	DB22-4	D	142	74	510	495	160	8.7
	DB30-4C		420	388	660	628	140	11
	DB37-4C						14	
	DB45-4C						19	
	DB55-4C	21						
	DB75-4C	E	550	520	283	240	440	26
	DB110-4C		30					
	DB132-4C		41					
	DB160-4C		57					
	DB200-4C		43					
DB220-4C*	74							

* DB220-4C is a set of two with the above dimensions.

AC Reactor
[10%EDSpec.]
[DB□□ - □C]

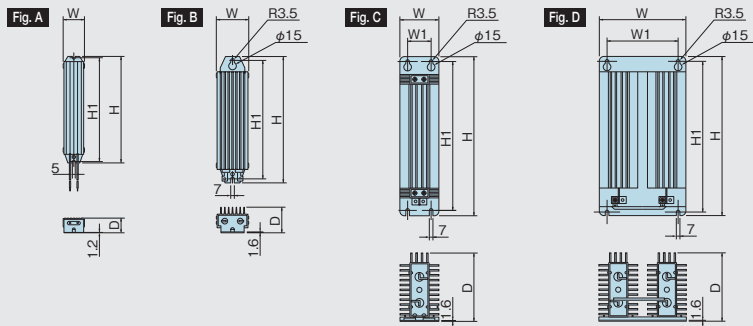

Voltage	Type	Dimensions [mm]				
		W	W1	H	H1	D
DB0.75-2C/4C	A	43	—	221	215	30.5
DB2.2-2C/4C	B	67	—	188	172	55
DB3.7-2C/4C		67	—	328	312	55
DB5.5-2C/4C		80	—	378	362	78
DB7.5-2C/4C		80	—	418	402	78
DB11-2C/4C	C	80	50	460	440	140
DB15-2C/4C		80	50	580	560	140
DB22-2C/4C	D	180	144	400	383	145

DC Reactor [DCR□-□□□]

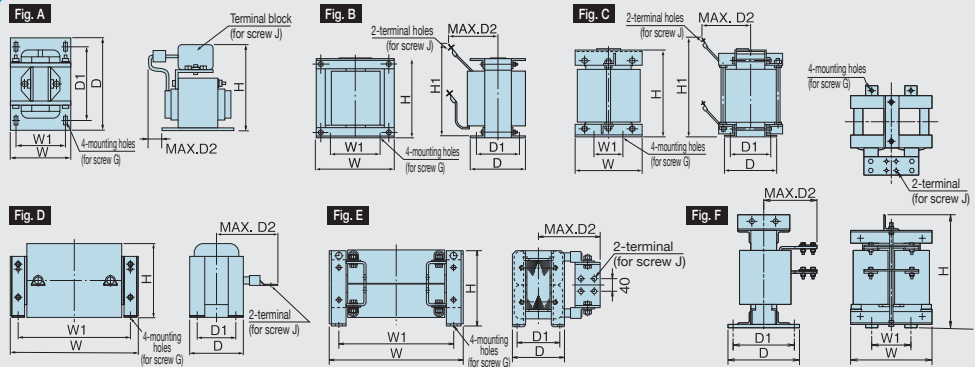

Voltage	Type	Fig	Dimensions [mm]									Approx. weight [kg]	
			W	W1	D	D1	D2	G	H	H1	J		
3-phase 200V	DCR2-0.4	A	66	56	90	72	15	M4(5,2x8)	94	—	M4	1.0	
	DCR2-0.75		66	56	90	72	20	M4(5,2x8)	94	—	M4	1.4	
	DCR2-1.5		66	56	90	72	20	M4(5,2x8)	94	—	M4	1.6	
	DCR2-2.2		86	71	100	80	10	M5(6x9)	110	—	M4	1.8	
	DCR2-3.7		86	71	100	80	20	M5(6x9)	110	—	M4	2.6	
	DCR2-5.5		111	95	100	80	20	M6(7x11)	130	—	M5	3.6	
	DCR2-7.5		111	95	100	80	23	M6(7x11)	130	—	M5	3.8	
	DCR2-11		111	95	100	80	24	M6(7x11)	137	—	M6	4.3	
	DCR2-15		146	124	120	96	15	M6(7x11)	180	—	M8	5.9	
	DCR2-18.5		146	124	120	96	25	M6(7x11)	180	—	M8	7.4	
	DCR2-22A	146	124	120	96	25	M6(7x11)	180	—	M8	7.5		
	DCR2-30B	B	152	90	156	116	115	M6(φ8)	130	190	M10	12	
	DCR2-37B		171	110	151	110	115	M6(φ8)	150	200	M10	14	
	DCR2-37C	D	210	185	101	81	125	M6(7x13)	125	—	M10	7.4	
	DCR2-45B	B	171	110	166	125	120	M6(φ8)	150	200	M10	16	
	DCR2-45C	D	210	185	106	86	135	M6(7x13)	125	—	M12	8.4	
	DCR2-55B	C	190	160	131	90	100	M6(φ8)	210	250	M12	16	
	DCR2-55C	D	255	225	96	76	140	M6(7x13)	145	—	M12	11	
	DCR2-75C		255	225	106	86	145	M6(7x13)	145	—	M12	12	
	DCR2-90C		255	225	116	96	155	M6(7x13)	145	—	M12	14	
DCR2-110C	300		265	116	90	185	M8(10x18)	160	—	M12	17		
3-phase 400V	DCR4-0.4	A	66	56	90	72	15	M4(5,2x8)	94	—	M4	1.0	
	DCR4-0.75		66	56	90	72	20	M4(5,2x8)	94	—	M4	1.4	
	DCR4-1.5		66	56	90	72	20	M4(5,2x8)	94	—	M4	1.6	
	DCR4-2.2		86	71	100	80	15	M5(6x9)	110	—	M4	2.0	
	DCR4-3.7		86	71	100	80	20	M5(6x9)	110	—	M4	2.6	
	DCR4-5.5		86	71	100	80	20	M5(6x9)	110	—	M4	2.6	
	DCR4-7.5		111	95	100	80	24	M6(7x11)	130	—	M5	4.2	
	DCR4-11		111	95	100	80	24	M6(7x11)	130	—	M5	4.3	
	DCR4-15		146	124	120	96	15	M6(7x11)	168	—	M5	5.9	
	DCR4-18.5		146	124	120	96	25	M6(7x11)	171	—	M6	7.2	
	DCR4-22A		146	124	120	96	25	M6(7x11)	171	—	M6	7.2	
	DCR4-30B		B	152	90	157	115	100	M6(φ8)	130	190	M8	13
	DCR4-37B		B	171	110	150	110	100	M6(φ8)	150	200	M8	15
	DCR4-37C		C	210	185	101	81	105	M6(7x13)	125	—	M8	7.4
	DCR4-45B		B	171	110	165	125	110	M6(φ8)	150	210	M8	18
	DCR4-45C	C	210	185	106	86	120	M6(7x13)	125	—	M8	8.4	
	DCR4-55B	B	171	110	170	130	110	M6(φ8)	150	210	M8	20	
	DCR4-55C	C	255	225	96	76	120	M6(7x13)	145	—	M10	11	
	DCR4-75C	C	255	225	106	86	125	M6(7x13)	145	—	M10	13	
	DCR4-90C		255	225	116	96	140	M6(7x13)	145	—	M12	15	
	DCR4-110C		300	265	116	90	175	M8(10x18)	155	—	M12	19	
	DCR4-132C		300	265	126	100	180	M8(10x18)	160	—	M12	22	
	DCR4-160C		350	310	131	103	180	M10(12x22)	190	—	M12	26	
	DCR4-200C		350	310	141	113	185	M10(12x22)	190	—	M12	30	
	DCR4-220C		350	310	146	118	200	M10(12x22)	190	—	M12	33	
	DCR4-250C		350	310	161	133	210	M10(12x22)	190	—	M12	35	
	DCR4-280C		350	310	161	133	210	M10(12x22)	190	—	M16	37	
	DCR4-315C	E	400	345	146	118	200	M10(12x22)	225	—	M16	40	
	DCR4-355C		400	345	156	128	200	M10(12x22)	225	—	4xM12	49	
	DCR4-400C		445	385	145	117	213	M10(12x22)	245	—	4xM12	52	
DCR4-450C	440		385	150	122	215	M10(12x22)	245	—	4xM12	62		
DCR4-500C	445		390	165	137	220	M10(12x22)	245	—	4xM12	72		
DCR4-560C	F		270	145	203	170	195	M12(14x20)	485	—	2xM12	70	
DCR4-630C		285	145	203	170	195	M12(14x20)	480	—	2xM12	75		
DCR4-710C		340	160	295	255	225	M12(φ15)	480	—	4xM12	95		

* The DCR2/4-□□□□ type is also prepared for motors with 75 kW or larger, which are applicable as standard. Contact us for ordering product separately.

* If using motors with output of 75 kW or higher, be sure to use a DC reactor (option).

DC Reactor Type	Remarks
Input power factor of DCR2/4-□□□□A/□□□□B: approx. 90 to 95%	The symbol at the end of the type code varies depending on the capacity.
Input power factor of the DCR2/4-□□□□C: about 86 to 90%	This can be selected with the inverter of 37kW or more.

Features
Main application examples
Model variations
Type number nomenclature
Standard specifications
Common specifications
Terminal specifications
Basic wiring diagram
External dimensions
Keypad
Function codes
Options
Product warranty

Braking unit [BU□□-□E]

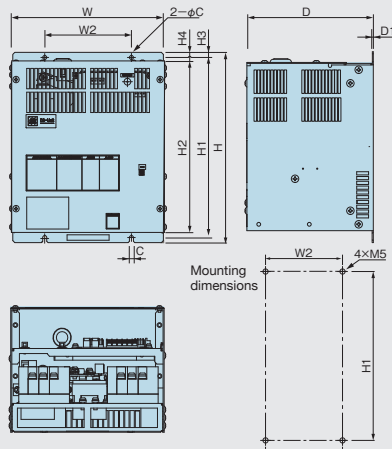

Voltage	Type	Dimensions [mm]											Approx. weight [kg]
		W	W1	W2	W3	H	H1	H2	H3	H4	D	D1	
3-phase 200V	BU90-2E	250	—	150	—	370	355	340	7.5	15	160	2.4	9
	BU90-4E	230	—	130	—	280	265	250	7.5	15	160	1.2	5.5
3-phase 400V	BU132-4E	250	—	150	—	370	355	340				2.4	9
	BU220-4E					450	435	420	2.4	13			

Fan unit for braking unit

The duty cycle [%ED] of the model with an external braking unit is increased from 10% ED to 30% ED by using this option.

Fan unit

● BU-F

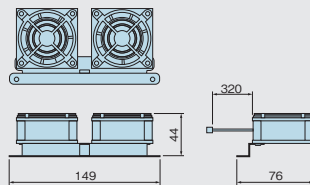

Braking unit + Fan unit

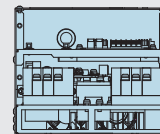
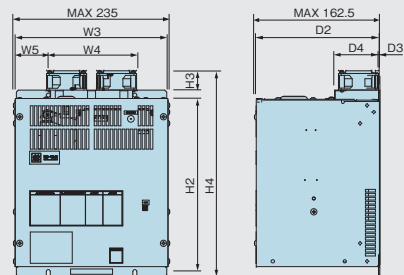

Voltage	Type	Dimensions [mm]									
		W3	W4	W5	H2	H3	H4	D2	D3	D4	
3-phase 200V	BU90-2EF	250	135	57.5	370	30	400	160	1.2	64	
	BU90-4EF	230	135	47.5	280	30	310	160	1.2	64	
3-phase 400V	BU132-4EF	250		57.5	370		400				
	BU220-4EF	250	57.5	450	480						

AC Reactor
[ACR□ - □□□]

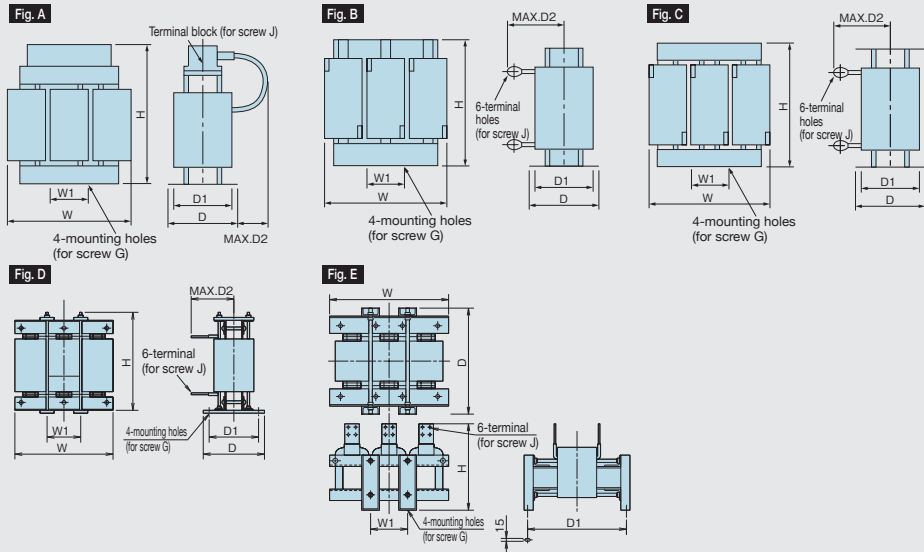

Voltage	Type	Fig	Dimensions [mm]								Approx. weight [kg]	
			W	W1	D	D1	D2	G	H	J		
3-phase 200V	ACR2-0.4A	A	120	40	90	65	20	M5 (6×10)	115	M4	1.4	
	ACR2-0.75A		120	40	100	75	20	M5 (6×10)	115	M4	1.9	
	ACR2-1.5A		120	40	100	75	20	M5 (6×10)	115	M4	2	
	ACR2-2.2A		120	40	100	75	20	M5 (6×10)	115	M4	2	
	ACR2-3.7A		125	40	100	75	25	M5 (6×10)	125	M4	2.4	
	ACR2-5.5A		125	40	115	90	25	M5 (6×10)	125	M4	3.1	
	ACR2-7.5A	B	125	40	115	90	106	M5 (6×10)	95	M5	3.1	
	ACR2-11A		125	40	125	100	106	M5 (6×10)	95	M6	3.7	
	ACR2-15A		180	60	110	85	106	M6 (7×11)	115	M6	4.8	
	ACR2-18.5A		180	60	110	85	109	M6 (7×11)	115	M6	5.1	
	ACR2-22A		180	60	110	85	109	M6 (7×11)	115	M6	5.1	
	ACR2-37		190	60	120	90	172	M6 (7×11)	190	M8	11	
	ACR2-55	C	190	60	120	90	200	M6 (7×11)	190	M12	13	
	ACR2-75		250	100	120	90	200	M8 (9×14)	250	M12	25	
ACR2-90	285		190	158	120	190	M10 (12×20)	210	M12	26		
ACR2-110	280		150	138	110	200	M8 (10×20)	270	M12	30		
3-phase 400V	ACR4-0.75A	B	120	40	90	65	106	M5 (6×10)	85	M4	1.1	
	ACR4-1.5A		125	40	100	75	106	M5 (6×10)	85	M4	1.9	
	ACR4-2.2A		125	40	100	75	106	M5 (6×10)	95	M4	2.2	
	ACR4-3.7A		125	40	100	75	106	M5 (6×10)	95	M4	2.4	
	ACR4-5.5A		125	40	115	90	106	M5 (6×10)	95	M5	3.1	
	ACR4-7.5A		125	40	115	90	106	M5 (6×10)	95	M5	3.7	
	ACR4-11A		180	60	110	85	106	M6 (7×11)	115	M6	4.3	
	ACR4-15A		180	60	110	85	106	M6 (7×11)	137	M6	5.4	
	ACR4-18.5A		180	60	110	85	106	M6 (7×11)	137	M6	5.7	
	ACR4-22A		180	60	110	85	106	M6 (7×11)	137	M6	5.9	
	ACR4-37	C	190	60	120	90	172	M6 (7×11)	190	M8	12	
	ACR4-55		190	60	120	90	200	M6 (7×11)	190	M10	14	
	ACR4-75		190	60	126	90	157	M6 (7×10)	190	M10	16	
	ACR4-110		250	100	136	105	202	M8 (9.5×18)	245	M12	24	
	ACR4-132		250	100	146	115	207	M8 (10×16)	250	M12	32	
	ACR4-220		320	120	150	110	240	M10 (12×20)	300	M12	40	
	ACR4-280		380	130	150	110	260	M10 (12×20)	300	M12	52	
	ACR4-355		380	130	150	110	260	M10 (12×20)	300	M12	52	
	ACR4-450		D	460	155	290	230	200	M12 (φ15)	490	4×M12	95
	ACR4-530		E	480	155	420	370	—	M12 (15×25)	380	4×M12	100
ACR4-630	510	170		420	370	—	M12 (15×25)	390	4×M12	110		

Note) It is not necessary to use the reactor unless a particularly stable power supply is required, i.e., DC bus connection operation (PN connection operation).
Use the DC reactor (DCR) as a measure against harmonics.

Features
Main application examples
Model variations
Type number nomenclature
Standard specifications
Common specifications
Terminal specifications
Basic wiring diagram
External dimensions
Keypad
Function codes
Options
Product warranty

Output circuit filter (OFL-□□□-4A)

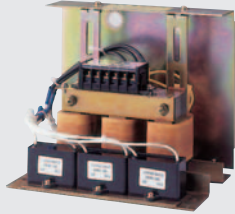

Filter dimensions (22kW or less)

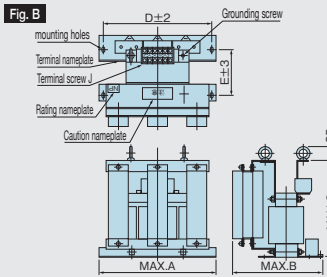
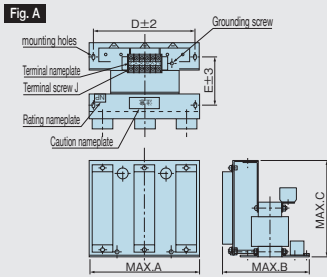

Filter dimensions (30kW or more):reactor

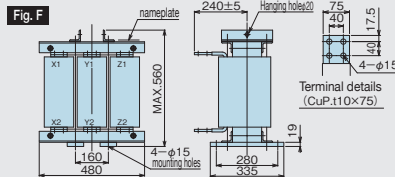
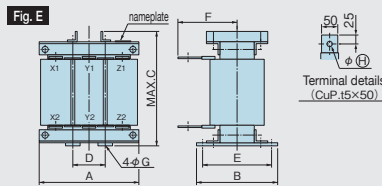
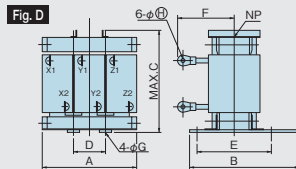
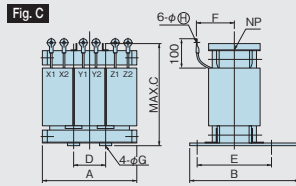

Filter dimensions (30kW or more):resistor/capacitor

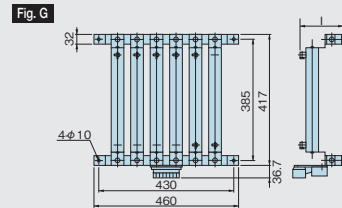

The reactor, capacitor and resistor for filter OFL-30-4A or larger have to be installed separately.

(Those items are not included in the mass indicated in the table below. They are shipped as a set by ordering the filter.)

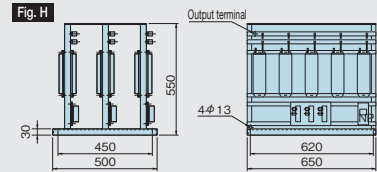

Type	Fig	Dimensions [mm]								Approx. weight [kg]						
		A	B	C	D	E	F	I	Grounding screw	Terminal screw H	Terminal screw (G: mounting hole)	Filter	Reactor	Resistor and capacitor		
3-phase 400V	A	OFL-0.4-4A	220	175	195	200	95			M4	M4	M5	7			
		OFL-1.5-4A		225	220		115						14			
		OFL-3.7-4A		290	290	230	260	160			M5	M5	M6	22		
		OFL-7.5-4A		330	275	310	300	145			M6	M6	M8	35		
	OFL-15-4A	B	300	300	330	300	170						45			
	OFL-30-4A	C G	210	175	210	70	140	90								
	OFL-37-4A		220	190	220	75	150	95	160		6.4	8		12	3	
	OFL-45-4A			195	265	70	155	140					15			
	OFL-55-4A			200	275		160				8.4	10		17	5.5	
	OFL-75-4A	D G	260	210	290	85	170	150						22		
	OFL-90-4A										10.5	12		25		
	OFL-110-4A			230	330		190	170	233				28		10	
	OFL-132-4A	300		240	340	100	200	180					38			
	OFL-160-4A												42			
	OFL-200-4A		320	270	350	105	220	190					48		13	
	OFL-220-4A	340		300	390	115	250	200					60		16	
	OFL-280-4A									333				70		
	OFL-315-4A	350		275	450		230	170					78		19	
	OFL-355-4A												90			
	OFL-400-4A	E H	440	290	480		245	175					100			
	OFL-450-4A			295	510	150	240						110			
	OFL-500-4A			325	470		270	195				15	15	125		36
	OFL-630-4A			335	500		280	210						145		
	OFL-630-4A	F+H	480	335	560	160	280	240					170			

* This filter is not limited by carrier frequency.

Zero-phase reactor for reducing radiated noise [ACL-40C, ACL-74C, F200160]

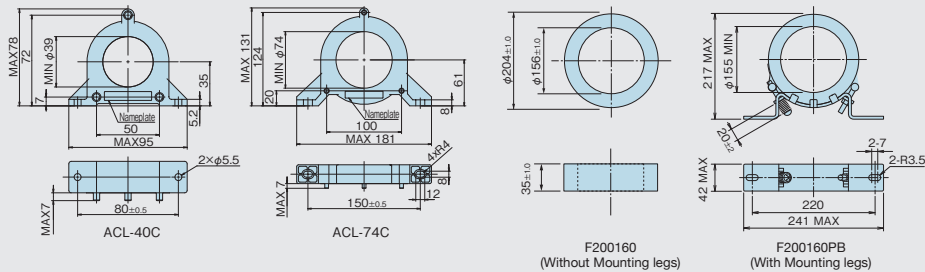

Applied wire size list

Type	Q'ty	No. of turns	Recommended wire size [mm ²] Note
ACL-40C	1	4	2.0, 3.5, 5.5
	2	2	8, 14
ACL-74C	1	4	8, 14
	2	2	22, 38, 60, 5.5×2, 8×2, 14×2, 22×2
	4	1	100, 150, 200, 250, 38×2, 60×2, 100×2
F200160 F200160PB	4	1	325, 150×2, 200×2, 250×2, 325×2, 150×3, 200×3, 250×3, 325×3, 250×4, 325×4

NOTE) Use a 600V HIV insulation cable (Allowable temp. 75°C).

EMC compliance filter [EFL-□□□, FS□□, FN□□]

Filter

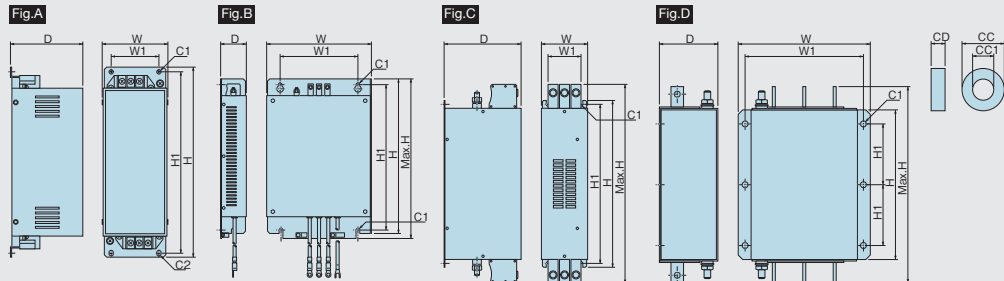

Core

EMC filter type	Rated voltage [V]	Rated current [A]	Fig	Filter dimensions [mm]							Core dimensions [mm]				
				W	W1	MAX.H	H	H1	D	C1	C2	Mass [kg]	CC	CC1	CD
EFL-0.75SP-2	230	6	A	85	59	—	243	228	93	φ5	5x7Elongated hole	1.5	51	25	17
EFL-3.7SP-2		25	A	105	80	—	233	215	136	φ6	6x8Elongated hole	2.5	71	41	18
EFL-7.5SP-2		50	A	120	95	—	273	254	158	φ7	7x9Elongated hole	5	71	71	18
EFL-15SP-2		100	A	205	160	—	513	487	193	φ11	11x13Elongated hole	20	100	72	27
EFL-22SP-2		150	A	205	160	—	513	487	193	φ11	11x13Elongated hole	20	100	72	27
FS21312-18-07	480	18	B	155	105	—	310	293	45	φ5.3	—	1.3	—	—	—
FS21312-44-07		44	B	225	167	—	331	311	55	φ8.3	—	2.5	—	—	—
FS21312-78-07		78	B	250	185	—	480	449	90	φ8.3	—	5	—	—	—
FS5536-5-07 (EFL-0.75G11-4)		5	B	116	90	320	310	293	42	φ5.3	—	0.9	—	—	—
FS5536-12-07 (EFL-4.0G11-4)		12	B	155	105	320	310	293	45	φ5.3	—	1.2	—	—	—
FS5536-35-07 (EFL-7.5G11-4)		35	B	225	167	341	331	311	47.5	φ8.3	—	1.8	—	—	—
FS5536-50-07 (EFL-15G11-4)		50	B	250	185	500	480	449	70	φ8.3	—	3.6	—	—	—
FS5536-72-07 (EFL-22G11-4)		72	B	250	185	500	480	449	70	φ8.3	—	4	—	—	—
FS5536-100-35		100	C	90	65	380	320	305	150	φ6.5	—	4.3	—	—	—
FS5536-180-40		180	C	120	102	451	380	365	170	φ6.5	—	6.5	—	—	—
FS5536-250-99-1		250	D	260	235	386	306	120	115	φ12	—	9.4	—	—	—
FS5536-400-99-1		400	D	260	235	386	306	120	115	φ12	—	11.5	—	—	—
FN3359-600-99		600	D	260	235	386	306	120	135	φ12	—	11	—	—	—
FN3359-800-99		800	D	280	255	456	356	145	170	φ12	—	18	—	—	—
FN3359-1000-99		1000	D	280	255	456	356	145	170	φ12	—	18	—	—	—
FN3359-1600-99		1600	D	300	275	586	406	170	160	φ12	—	27	—	—	—

To all our customers who purchase Fuji Electric products included in this catalog:

Please take the following items into consideration when placing your order.

When requesting an estimate and placing your orders for the products included in these materials, please be aware that any items such as specifications which are not specifically mentioned in the contract, catalog, specifications or other materials will be as mentioned below. In addition, the products included in these materials are limited in the use they are put to and the place where they can be used, etc., and may require periodic inspection. Please confirm these points with your sales representative or directly with this company. Furthermore, regarding purchased products and delivered products, we request that you take adequate consideration of the necessity of rapid receiving inspections and of product management and maintenance even before receiving your products.

1. Free of Charge Warranty Period and Warranty Range

1-1 Free of charge warranty period

- (1) The product warranty period is "1 year from the date of purchase" or 24 months from the manufacturing date imprinted on the name plate, whichever date is earlier.
- (2) However, in cases where the operating environment, conditions of use, use frequency and times used, etc., have an effect on product life, this warranty period may not apply.
- (3) Furthermore, the warranty period for parts restored by Fuji Electric's Service Department is "6 months from the date that repairs are completed."

1-2 Warranty range

- (1) In the event that breakdown occurs during the product's warranty period which is the responsibility of Fuji Electric, Fuji Electric will replace or repair the part of the product that has broken down free of charge at the place where the product was purchased or where it was delivered. However, if the following cases are applicable, the terms of this warranty may not apply.
 - 1) The breakdown was caused by inappropriate conditions, environment, handling or use methods, etc. which are not specified in the catalog, operation manual, specifications or other relevant documents.
 - 2) The breakdown was caused by the product other than the purchased or delivered Fuji's product.
 - 3) The breakdown was caused by the product other than Fuji's product, such as the customer's equipment or software design, etc.
 - 4) Concerning the Fuji's programmable products, the breakdown was caused by a program other than a program supplied by this company, or the results from using such a program.
 - 5) The breakdown was caused by modifications or repairs affected by a party other than Fuji Electric.
 - 6) The breakdown was caused by improper maintenance or replacement using consumables, etc. specified in the operation manual or catalog, etc.
 - 7) The breakdown was caused by a chemical or technical problem that was not foreseen when making practical application of the product at the time it was purchased or delivered.
 - 8) The product was not used in the manner the product was originally intended to be used.
 - 9) The breakdown was caused by a reason which is not this company's responsibility, such as lightning or other disaster.
- (2) Furthermore, the warranty specified herein shall be limited to the purchased or delivered product alone.
- (3) The upper limit for the warranty range shall be as specified in item (1) above and any damages (damage to or loss of machinery or equipment, or lost profits from the same, etc.) consequent to or resulting from breakdown of the purchased or delivered product shall be excluded from coverage by this warranty.

1-3. Trouble diagnosis

As a rule, the customer is requested to carry out a preliminary trouble diagnosis. However, at the customer's request, this company or its service network can perform the trouble diagnosis on a chargeable basis. In this case, the customer is asked to assume the burden for charges levied in accordance with this company's fee schedule.

2. Exclusion of Liability for Loss of Opportunity, etc.

Regardless of whether a breakdown occurs during or after the free of charge warranty period, this company shall not be liable for any loss of opportunity, loss of profits, or damages arising from special circumstances, secondary damages, accident compensation to another company, or damages to products other than this company's products, whether foreseen or not by this company, which this company is not be responsible for causing.

3. Repair Period after Production Stop, Spare Parts Supply Period (Holding Period)

Concerning models (products) which have gone out of production, this company will perform repairs for a period of 7 years after production stop, counting from the month and year when the production stop occurs. In addition, we will continue to supply the spare parts required for repairs for a period of 7 years, counting from the month and year when the production stop occurs. However, it is estimated that the life cycle of certain electronic and other parts is short and it will be difficult to procure or produce those parts, so there may be cases where it is difficult to provide repairs or supply spare parts even within this 7-year period. For details, please confirm at our company's business office or our service office.

4. Transfer Rights

In the case of standard products which do not include settings or adjustments in an application program, the products shall be transported to and transferred to the customer and this company shall not be responsible for local adjustments or trial operation.

5. Service Contents

The cost of purchased and delivered products does not include the cost of dispatching engineers or service costs. Depending on the request, these can be discussed separately.

6. Applicable Scope of Service

Above contents shall be assumed to apply to transactions and use of the country where you purchased the products. Consult the local supplier or Fuji for the detail separately.

Trademarks

- DeviceNet is a trademark of the ODVA.
- Ethernet is a trademark of Fuji Xerox Corporation in Japan.
- BACnet is a trademark of ASHRAE.
- CC-Link is a trademark of the Mitsubishi Electric.
- PROFINET is a trademark of the PROFIBUS Nutzerorganisation e.V.
- Ethercat is a trademark of the Beckhoff Automation GmbH.
- PROFIBUS is a trademark of the PROFIBUS Nutzerorganisation e.V.
- EtherNet/IP is a trademark of the ODVA Inc..
- Bluetooth is a trademark of the Bluetooth SIG, Inc.
- CAN open® is a trademark of the CAN in Automation.
- MODBUS is a trademark of Schneider automation inc.



NOTES

When running general-purpose motors

• Driving a 400V general-purpose motor

When driving a 400V general-purpose motor with an inverter using extremely long cables, damage to the insulation of the motor may occur. Use an output circuit filter (OFL) if necessary after checking with the motor manufacturer. Fuji's motors do not require the use of output circuit filters because of their reinforced insulation.

• Torque characteristics and temperature rise

When the inverter is used to run a general-purpose motor, the temperature of the motor becomes higher than when it is operated using a commercial power supply. In the low-speed range, the cooling effect will be weakened, so decrease the output torque of the motor. If constant torque is required in the low-speed range, use a Fuji inverter motor or a motor equipped with an externally powered ventilating fan.

• Vibration

When the motor is mounted to a machine, resonance may be caused by the natural frequencies, including that of the machine. Operation of a 2-pole motor at 60Hz or more may cause abnormal vibration.

* Study use of tier coupling or dampening rubber.

* It is also recommended to use the inverter jump frequency control to avoid resonance points.

• Noise

When an inverter is used with a general-purpose motor, the motor noise level is higher than that with a commercial power supply. To reduce noise, raise carrier frequency of the inverter. High-speed operation at 60Hz or more can also result in more noise.

When running special motors

• High-speed motors

When driving a high-speed motor while setting the frequency higher than 120Hz, test the combination with another motor to confirm the safety of high-speed motors.

• Explosion-proof motors

When driving an explosion-proof motor with an inverter, use a combination of a motor and an inverter that has been approved in advance.

• Submersible motors and pumps

These motors have a larger rated current than general-purpose motors. Select an inverter whose rated output current is greater than that of the motor.

These motors differ from general-purpose motors in thermal characteristics. Set a low value in the thermal time constant of the motor when setting the electronic thermal function.

• Brake motors

For motors equipped with parallel-connected brakes, their braking power must be supplied from the primary circuit (commercial power supply). If the brake power is connected to the inverter power output circuit (secondary circuit) by mistake, problems may occur.

Do not use inverters for driving motors equipped with series-connected brakes.

• Geared motors

If the power transmission mechanism uses an

oil-lubricated gearbox or speed changer/reducer, then continuous motor operation at low speed may cause poor lubrication. Avoid such operation.

• Synchronous motors

It is necessary to use software suitable for this motor type. Contact Fuji for details.

• Single-phase motors

Single-phase motors are not suitable for inverter-driven variable speed operation. Use three-phase motors.

* Even if a single-phase power supply is available, use a three-phase motor as the inverter provides three-phase output.

Environmental conditions

• Installation location

Use the inverter in a location with an ambient temperature range of -10 to 50°C.

The inverter and braking resistor surfaces become hot under certain operating conditions. Install the inverter on nonflammable material such as metal.

Ensure that the installation location meets the environmental conditions specified in "Environment" in inverter specifications.

Combination with peripheral devices

• Installing a molded case circuit breaker (MCCB)

Install a recommended molded case circuit breaker (MCCB) or an earth leakage circuit breaker (ELCB) in the primary circuit of each inverter to protect the wiring. Ensure that the circuit breaker capacity is equivalent to or lower than the recommended capacity.

• Installing a magnetic contactor (MC) in the output (secondary) circuit

If a magnetic contactor (MC) is mounted in the inverter's secondary circuit for switching the motor to commercial power or for any other purpose, ensure that both the inverter and the motor are fully stopped before you turn the MC on or off. Remove the surge killer integrated with the MC.

• Installing a magnetic contactor (MC) in the input (primary) circuit

Do not turn the magnetic contactor (MC) in the primary circuit on or off more than once an hour as an inverter fault may result. If frequent starts or stops are required during motor operation, use FWD/REV signals.

• Protecting the motor

The electronic thermal function of the inverter can protect the motor. The operation level and the motor type (general-purpose motor, inverter motor) should be set. For high-speed motors or water-cooled motors, set a small value for the thermal time constant to protect the motor.

If you connect the motor thermal relay to the motor with a long cable, a high-frequency current may flow into the wiring stray capacitance. This may cause the relay to trip at a current lower than the set value for the thermal relay. If this happens, lower the carrier frequency or use the output circuit filter (OFL).

• Regarding power-factor correcting capacitor

Do not mount power factor correcting capacitors in the inverter (primary) circuit. Use the DC REACTOR to improve the inverter power factor. Do

not use power factor correcting capacitors in the inverter output circuit (secondary). An overcurrent trip will occur, disabling motor operation.

• Discontinuance of surge killer

Do not mount surge killers in the inverter output (secondary) circuit.

• Reducing noise

Use of a filter and shielded wires are typical measures against noise to ensure that EMC Directives are met.

• Measures against surge currents

If an overvoltage trip occurs while the inverter is stopped or operated under a light load, it is assumed that the surge current is generated by open/close of the phase-advancing capacitor in the power system.

We recommend connecting a DC REACTOR to the inverter.

• Megger test

When checking the insulation resistance of the inverter, use a 500V megger and follow the instructions contained in the Instruction Manual.

Wiring

• Wiring distance of control circuit

When performing remote operation, use twisted shield wire and limit the distance between the inverter and the control box to 20m.

• Wiring length between inverter and motor

If long wiring is used between the inverter and the motor, the inverter will overheat or trip as a result of overcurrent (high-frequency current flowing into the stray capacitance) in the wires connected to the phases. Ensure that the wiring is shorter than 50m. If this length must be exceeded, lower the carrier frequency or mount an output circuit filter (OFL).

• Wiring size

Select cables with a sufficient capacity by referring to the current value or recommended wire size.

• Wiring type

Do not use multicore cables that are normally used for connecting several inverters and motors.

• Grounding

Securely ground the inverter using the grounding terminal.

Selecting inverter capacity

• Driving general-purpose motor

Select an inverter according to the applicable motor ratings listed in the standard specifications table for the inverter. When high starting torque is required or quick acceleration or deceleration is required, select an inverter with a capacity one size greater than the standard.

• Driving special motors

Select an inverter that meets the following condition: Inverter rated current > Motor rated current.

Transportation and storage

When transporting or storing inverters, follow the procedures and select locations that meet the environmental conditions that agree with the inverter specifications.