

# User's Manual

## USER'S MANUAL

### *FRENIC-Mini* (C2) Series



Compact Inverter  
***FRENIC-Mini***

**User's Manual**

Copyright © 2013-2014 Fuji Electric Co., Ltd.

All rights reserved.

No part of this publication may be reproduced or copied without prior written permission from Fuji Electric Co., Ltd.

All products and company names mentioned in this manual are trademarks or registered trademarks of their respective holders.

The information contained herein is subject to change without prior notice for improvement.



# Preface

This manual provides all the information on the FRENIC-Mini series of inverters including its operating procedure, operation modes, and selection of peripheral equipment. Carefully read this manual for proper use. Incorrect handling of the inverter may prevent the inverter and/or related equipment from operating correctly, shorten their lives, or cause problems.

The table below lists the other materials related to the use of the FRENIC-Mini. Read them in conjunction with this manual as necessary.

Name	Material No.	Description
Catalog	24A1-E-0011	Product scope, features, specifications, external drawings, and options of the product
Instruction Manual	INR-SI47-1729-E	Acceptance inspection, mounting & wiring of the inverter, operation using the keypad, running the motor for a test, troubleshooting, and maintenance and inspection
RS-485 Communication User's Manual	MEH448	Overview of functions implemented by the use of RS-485 communication, the communications specifications, Modbus RTU/Fuji general-purpose inverter protocol, related function codes, and data formats

The materials are subject to change without notice. Be sure to obtain the latest editions for use.

## **Guideline for Suppressing Harmonics in Home Electric and General-purpose Appliances**

Our three-phase, 200 V class series inverters of 3.7 kW or less (FRENIC-Mini series) were the products of which were restricted by the "Guideline for Suppressing Harmonics in Home Electric and General-purpose Appliances" (established in September 1994 and revised in October 1999) issued by the Ministry of Economy, Trade and Industry.

The above restriction, however, was lifted when the Guideline was revised in January 2004. Since then, the inverter makers have individually imposed voluntary restrictions on the harmonics of their products.

We, as before, recommend that you connect a reactor (for suppressing harmonics) to your inverter. As a reactor, select a "DC REACTOR" introduced in this manual. For use of the other reactor, please inquire of us about detailed specifications.

## **Japanese Guideline for Suppressing Harmonics by Customers Receiving High Voltage or Special High Voltage**

Refer to this manual, Appendix B for details on this guideline.

## Safety precautions

Read this manual and the FRENIC-Mini Instruction Manual (INR-SI47-1729-E) thoroughly before proceeding with installation, connections (wiring), operation, or maintenance and inspection. Ensure you have sound knowledge of the product and familiarize yourself with all safety information and precautions before proceeding to operate the inverter.

Safety precautions are classified into the following two categories in this manual.



<b>⚠ WARNING</b>	Failure to heed the information indicated by this symbol may lead to dangerous conditions, possibly resulting in death or serious bodily injuries.
<b>⚠ CAUTION</b>	Failure to heed the information indicated by this symbol may lead to dangerous conditions, possibly resulting in minor or light bodily injuries and/or substantial property damage.

Failure to heed the information contained under the CAUTION title can also result in serious consequences. These safety precautions are of utmost importance and must be observed at all times.

<b>⚠ CAUTION</b>
This product is not designed for use in appliances and machinery on which lives depend. Consult your Fuji Electric representative before considering the FRENIC-Mini series of inverters for equipment and machinery related to nuclear power control, aerospace uses, medical uses or transportation. When the product is to be used with any machinery or equipment on which lives depend or with machinery or equipment which could cause serious loss or damage should this product malfunction or fail, ensure that appropriate safety devices and/or equipment are installed.

## ■ Precautions for Use

In running general-purpose motors	Driving a 400 V general-purpose motor	When driving a 400 V general-purpose motor with an inverter using extremely long wires, damage to the insulation of the motor may occur. Use an output circuit filter (OFL) if necessary after checking with the motor manufacturer. Fuji motors do not require the use of output circuit filters because of their reinforced insulation.
	Torque characteristics and temperature rise	When the inverter is used to run a general-purpose motor, the temperature of the motor becomes higher than when it is operated using a commercial power supply. In the low-speed range, the cooling effect will be weakened, so decrease the output torque of the motor. If constant torque is required in the low-speed range, use a Fuji inverter motor or a motor equipped with an externally powered ventilating fan.
	Vibration	When an inverter-driven motor is mounted to a machine, resonance may be caused by the natural frequencies of the machine system. Note that operation of a 2-pole motor at 60 Hz or higher may cause abnormal vibration. * The use of a rubber coupling or vibration-proof rubber is recommended. * Use the inverter's jump frequency control feature to skip the resonance frequency zone(s).
	Noise	When an inverter is used with a general-purpose motor, the motor noise level is higher than that with a commercial power supply. To reduce noise, raise carrier frequency of the inverter. Operation at 60 Hz or higher can also result in higher level of wind roaring sound.
In running special motors	High-speed motors	If the reference frequency is set to 120 Hz or more to drive a high-speed motor, test-run the combination of the inverter and motor beforehand to check for safe operation.
	Explosion-proof motors	When driving an explosion-proof motor with an inverter, use a combination of a motor and an inverter that has been approved in advance.
	Submersible motors and pumps	These motors have a higher rated current than general-purpose motors. Select an inverter whose rated output current is higher than that of the motor. These motors differ from general-purpose motors in thermal characteristics. Set a low value in the thermal time constant of the motor when setting the electronic thermal overcurrent protection (for motor).
	Brake motors	For motors equipped with parallel-connected brakes, their power supply for brake must be supplied from the inverter's primary circuit. If the power supply for brake is connected to the inverter's output circuit by mistake, the brake will not work. Do not use inverters for driving motors with series-connected brake coils.
	Geared motors	If the power transmission mechanism uses an oil-lubricated gearbox or speed changer/reducer, then continuous motor operation at low speed may cause poor lubrication. Avoid such operation.
	Single-phase motors	Single-phase motors are not suitable for inverter-driven variable speed operation. Use three-phase motors.
Environmental conditions	Installation location	Use the inverter within the ambient temperature range from -10 to +50°C. The heat sink and braking resistor of the inverter may become hot under certain operating conditions, so install the inverter on nonflammable material such as metal. Ensure that the installation location meets the environmental conditions specified in Chapter 8, Section 8.4 "Operating Environment and Storage Environment."

Combina- tion with peripheral devices	Installing an MCCB or RCD/ELCB	Install a recommended molded case circuit breaker (MCCB) or residual-current-operated protective device (RCD)/earth leakage circuit breaker (ELCB) (with overcurrent protection) in the primary circuit of each inverter to protect the wiring. Ensure that the circuit breaker capacity is equivalent to or lower than the recommended capacity.
	Installing an MC in the secondary circuit	If a magnetic contactor (MC) is installed in the inverter's output (secondary) circuit for switching the motor to commercial power or for any other purpose, ensure that both the inverter and the motor are completely stopped before you turn the MC on or off.  Remove a surge killer integrated with the magnetic contactor in the inverter's output (secondary) circuit.
	Installing an MC in the primary circuit	Do not turn the magnetic contactor (MC) in the primary circuit on or off more than once an hour as an inverter failure may result.  If frequent starts or stops are required during motor operation, use terminal [FWD]/[REV] signals or the  /  key.
	Protecting the motor	The electronic thermal feature of the inverter can protect the motor. The operation level and the motor type (general-purpose motor, inverter motor) should be set. For high-speed motors or water-cooled motors, set a small value for the thermal time constant.  If you connect the motor thermal relay to the motor with a long wire, a high-frequency current may flow into the wiring stray capacitance. This may cause the thermal relay to trip at a current lower than the set value. If this happens, lower the carrier frequency or use the output circuit filter (OFL).
	Discontinuance of power-factor correcting capacitor	Do not connect power-factor correcting capacitors to the inverter's primary circuit. (Use the DC reactor to improve the inverter power factor.) Do not use power-factor correcting capacitors in the inverter's output (secondary) circuit. An overcurrent trip will occur, disabling motor operation.
	Discontinuance of surge killer	Do not connect a surge killer to the inverter's output (secondary) circuit.
	Reducing noise	Use of a filter and shielded wires is typically recommended to satisfy EMC Directive.  Refer to Appendices, App. A "Advantageous Use of Inverters (Notes on electrical noise)" for details.
	Measures against surge currents	If an overvoltage trip occurs while the inverter is stopped or operated under light load, it is assumed that the surge current is generated by open/close of the phase-advancing capacitor in the power system.  * Connect a DC reactor to the inverter.
	Megger test	When checking the insulation resistance of the inverter, use a 500 V megger and follow the instructions contained in the FRENIC-Mini Instruction Manual (INR-SI47-1729-E), Chapter 7, Section 7.5 "Insulation Test."

Wiring	Control circuit wiring length	When using remote control, limit the wiring length between the inverter and operator panel to 20 m or less and use twisted pair or shielded wire.
	Wiring length between inverter and motor	If long wiring is used between the inverter and the motor, the inverter may overheat or trip due to overcurrent because a higher harmonics current flows into the stray capacitance between each phase wire. Ensure that the wiring is shorter than 50 m. If this length must be exceeded, lower the carrier frequency or install an output circuit filter (OFL).
	Wire size	Select wires with a sufficient capacity by referring to the current value or recommended wire size.
	Wire type	Do not share one multi-core cable in order to connect several inverters with motors.
	Grounding	Securely ground the inverter using the grounding terminal.
Selecting inverter capacity	Driving general-purpose motor	Select an inverter according to the nominal applied motor ratings listed in the standard specifications table for the inverter.  When high starting torque is required or quick acceleration or deceleration is required, select an inverter with one rank larger capacity than the standard. Refer to Chapter 7, Section 7.1 "Selecting Motors and Inverters" for details.
	Driving special motors	Select an inverter that meets the following condition: Inverter rated current > Motor rated current
Transportation and storage	For transportation and storage instructions, see the FRENIC-Mini Instruction Manual (INR-SI47-1729-E), Chapter 1, Section 1.3 "Transportation" and Section 1.4 "Storage Environment."	

# How this manual is organized

This manual contains Chapters 1 through 9, and Appendices.

## Chapter 1 INTRODUCTION TO FRENIC-MINI

This chapter describes the features and control system of the FRENIC-Mini series, and the recommended configuration for the inverter and peripheral equipment.

## Chapter 2 PARTS NAMES AND FUNCTIONS

This chapter contains external views of the FRENIC-Mini series and an overview of terminal blocks, including a description of the LED display and keys on the keypad.

## Chapter 3 OPERATION USING THE KEYPAD

This chapter describes inverter operation using the keypad. The inverter features three operation modes (Running, Programming and Alarm modes) which enable you to run and stop the motor, monitor running status, set function code data, display running information required for maintenance, and display alarm data.

## Chapter 4 BLOCK DIAGRAMS FOR CONTROL LOGIC

This chapter describes the main block diagrams for the control logic of the FRENIC-Mini series of inverters.

## Chapter 5 RUNNING THROUGH RS-485 COMMUNICATIONS

This chapter describes an overview of inverter operation through the RS-485 communications facility. Refer to the RS-485 Communication User's Manual (MEH448) for details.

## Chapter 6 SELECTING PERIPHERAL EQUIPMENT

This chapter describes how to use a range of peripheral equipment and options, FRENIC-Mini's configuration with them, and requirements and precautions for selecting wires and crimp terminals.

## Chapter 7 SELECTING OPTIMAL MOTOR AND INVERTER CAPACITIES

This chapter provides you with information about the inverter output torque characteristics, selection procedure, and equations for calculating capacities to help you select optimal motor and inverter models. It also helps you select braking resistors.

## Chapter 8 SPECIFICATIONS

This chapter describes specifications of the output ratings, control system, and terminal functions for the FRENIC-Mini series of inverters. It also provides descriptions of the operating and storage environment, external dimensions, examples of basic connection diagrams, and details of the protective functions.

## Chapter 9 FUNCTION CODES

This chapter contains overview lists of seven groups of function codes available for the FRENIC-Mini series of inverters and details of each function code.

## Appendices

- App. A Advantageous Use of Inverters (Notes on electrical noise)
- App. B Japanese Guideline for Suppressing Harmonics by Customers Receiving High Voltage or Special High Voltage
- App. C Effect on Insulation of General-purpose Motors Driven with 400 V Class Inverters
- App. D Inverter Generating Loss
- App. E Conversion from SI Units
- App. F Allowable Current of Insulated Wires
- App. G Replacement Information

## Icons

The following icons are used throughout this manual.



This icon indicates information which, if not heeded, can result in the inverter not operating to full efficiency, as well as information concerning incorrect operations and settings which can result in accidents.



This icon indicates information that can prove handy when performing certain settings or operations.



This icon indicates a reference to more detailed information.

# CONTENTS

## Chapter 1 INTRODUCTION TO FRENIC-Mini

1.1	Features.....	1-1
1.2	Control System .....	1-10
1.3	Recommended Configuration .....	1-11

## Chapter 2 PARTS NAMES AND FUNCTIONS

2.1	External View and Terminal Blocks .....	2-1
2.2	Names and Functions of Keypad Components .....	2-2

## Chapter 3 OPERATION USING THE KEYPAD

3.1	Overview of Operation Modes .....	3-1
3.2	Running Mode .....	3-3
3.2.1	Run/stop the motor.....	3-3
3.2.2	Set up the reference frequency and PID process command .....	3-3
3.2.3	Monitor the running status .....	3-5
3.2.4	Jog (inch) the motor .....	3-7
3.3	Programming Mode.....	3-8
3.3.1	Setting the function codes--"Data Setting".....	3-9
3.3.2	Checking changed function codes--"Data Checking" .....	3-13
3.3.3	Monitoring the running status--"Drive Monitoring" .....	3-14
3.3.4	Checking I/O signal status--"I/O Checking" .....	3-17
3.3.5	Reading maintenance information--"Maintenance Information" .....	3-21
3.3.6	Reading alarm information-- "Alarm Information".....	3-24
3.4	Alarm Mode.....	3-28
3.4.1	Releasing the alarm and transferring the inverter to Running mode .....	3-28
3.4.2	Displaying the alarm history .....	3-28
3.4.3	Displaying the running information when an alarm occurs .....	3-29
3.4.4	Transferring to Programming mode .....	3-29

## Chapter 4 BLOCK DIAGRAMS FOR CONTROL LOGIC

4.1	Symbols Used in the Block Diagrams and their Meanings.....	4-1
4.2	Drive Frequency Command Generator.....	4-2
4.3	Drive Command Generator.....	4-4
4.4	Terminal Command Decoders .....	4-6
4.5	Digital Output Selector .....	4-10
4.6	Analog Output (FMA) Selector .....	4-12
4.7	Drive Command Controller .....	4-13
4.8	PID Frequency Command Generator.....	4-16

## Chapter 5 RUNNING THROUGH RS-485 COMMUNICATIONS

5.1	Overview on RS-485 Communication.....	5-1
5.1.1	Common specifications.....	5-2
5.1.2	Connector specifications .....	5-3
5.1.3	Connection .....	5-4
5.2	Overview of FRENIC Loader .....	5-5
5.2.1	Specifications.....	5-5
5.2.2	Connection .....	5-6
5.2.3	Function overview.....	5-6
5.2.3.1	Setting of function code .....	5-6
5.2.3.2	Running status monitor .....	5-7
5.2.3.3	Test-running .....	5-9



## Chapter 6 SELECTING PERIPHERAL EQUIPMENT

6.1	Configuring the FRENIC-Mini.....	6-1
6.2	Selecting Wires and Crimp Terminals.....	6-2
6.2.1	Recommended wires .....	6-4
6.2.2	Crimp terminals.....	6-12
6.3	Peripheral Equipment .....	6-13
6.4	Selecting Options.....	6-20
6.4.1	Peripheral equipment options.....	6-20
6.4.2	Options for operation and communications .....	6-33
6.4.3	Extended installation kit options .....	6-37
6.4.4	Meter options .....	6-40

## Chapter 7 SELECTING OPTIMAL MOTOR AND INVERTER CAPACITIES

7.1	Selecting Motors and Inverters .....	7-1
7.1.1	Motor output torque characteristics.....	7-1
7.1.2	Selection procedure.....	7-4
7.1.3	Equations for selections .....	7-7
7.1.3.1	Load torque during constant speed running .....	7-7
7.1.3.2	Acceleration and deceleration time calculation.....	7-8
7.1.3.3	Heat energy calculation of braking resistor.....	7-11
7.1.3.4	Calculating the RMS rating of the motor .....	7-12
7.2	Selecting a Braking Resistor.....	7-13
7.2.1	Selection procedure.....	7-13
7.2.2	Notes on selection .....	7-13

## Chapter 8 SPECIFICATIONS

8.1	Standard Models .....	8-1
8.1.1	Three-phase 200 V series .....	8-1
8.1.2	Three-phase 400 V series .....	8-2
8.1.3	Single-phase 200 V series .....	8-3
8.1.4	Single-phase 100 V series .....	8-4
8.2	Semi-standard Models .....	8-5
8.2.1	EMC filter built-in type in three-phase 400 V series.....	8-5
8.2.2	EMC filter built-in type in single-phase 200 V series .....	8-6
8.3	Common Specifications .....	8-7
8.4	Terminal Specifications .....	8-11
8.4.1	Terminal functions .....	8-11
8.4.2	Location of terminal blocks.....	8-19
8.4.3	Terminal arrangement diagram and screw specifications.....	8-20
8.4.3.1	Main circuit terminals .....	8-20
8.4.3.2	Control circuit terminals.....	8-22
8.5	Operating Environment and Storage Environment .....	8-24
8.5.1	Operating environment.....	8-24
8.5.2	Storage environment .....	8-25
8.5.2.1	Temporary storage.....	8-25
8.5.2.2	Long-term storage .....	8-25
8.6	External Dimensions.....	8-26
8.6.1	Standard models .....	8-26
8.6.2	EMC filter built-in type.....	8-32
8.7	Connection Diagrams .....	8-37
8.7.1	Keypad operation .....	8-37
8.7.2	Operation by external signal inputs.....	8-38
8.8	Details of Protective Functions.....	8-39

## Chapter 9 FUNCTION CODES

9.1	Function Code Tables .....	9-1
9.2	Details of Function Codes.....	9-20
9.2.1	F codes (Fundamental functions) .....	9-20
9.2.2	E codes (Extension terminal functions).....	9-47
9.2.3	C codes (Control functions) .....	9-71
9.2.4	P codes (Motor 1 parameters) .....	9-77
9.2.5	H codes (High performance functions) .....	9-81
9.2.6	A codes (Motor 2 parameters).....	9-107
9.2.7	J codes (Application functions).....	9-109
9.2.8	y codes (Link functions).....	9-119
9.3	Notes in Driving PMSM.....	9-124

## Appendices

App. A	Advantageous Use of Inverters (Notes on electrical noise).....	A-1
A.1	Effect of inverters on other devices .....	A-1
A.2	Noise.....	A-2
A.3	Noise prevention.....	A-4
App. B	Japanese Guideline for Suppressing Harmonics by Customers Receiving High Voltage or Special High Voltage .....	A-12
B.1	Application to general-purpose inverters.....	A-12
B.2	Compliance to the harmonic suppression for customers receiving high voltage or special high voltage .....	A-13
App. C	Effect on Insulation of General-purpose Motors Driven with 400 V Class Inverters.....	A-17
C.1	Generating mechanism of surge voltages .....	A-17
C.2	Effect of surge voltages .....	A-18
C.3	Countermeasures against surge voltages .....	A-18
C.4	Regarding existing equipment .....	A-19
App. D	Inverter Generating Loss .....	A-20
App. E	Conversion from SI Units.....	A-21
App. F	Allowable Current of Insulated Wires .....	A-23
App. G	Replacement Information .....	A-25
G.1	Compatibility and differences between FRENIC-Mini series FRN□□□□C1□-□□ and FRN□□□□C2□-□□ .....	A-25
G.2	External dimensions comparison tables.....	A-26
G.3	Terminal arrangements and symbols .....	A-29
G.4	Function codes.....	A-31

---

# Chapter 1

## INTRODUCTION TO FRENIC-Mini

This chapter describes the features and control system of the FRENIC-Mini series, and the recommended configuration for the inverter and peripheral equipment.

### Contents

1.1	Features .....	1-1
1.2	Control System.....	1-10
1.3	Recommended Configuration .....	1-11



## 1.1 Features

### Upgraded FRENIC-Mini (FRN□□□□C2□-□□) functions

- Dynamic torque vector control providing bumped-up torque performance

Fuji's original dynamic torque vector control broadens the range of applications.

- RS-485 communications port provided as standard to facilitate system configuration

While the original FRENIC-Mini series has an RS-485 communications port as an option, the upgraded one has it as standard, making it easy to connect the upgraded one to a PLC and facilitating system configuration.

- Slow flowrate stop function under PID control for further energy saving

Under PID control for constant pump discharge pressure, the slow flowrate stop function stops the inverter when the pump discharge pressure is high, which achieves further energy saving.

- Braking signal function making the FRENIC-Mini applicable to simple vertical lift applications

The upgraded FRENIC-Mini series supports brake ON/OFF signals that are conventionally supported by the upper inverter series only. The braking signal function enables the FRENIC-Mini to be applied to simple vertical lift applications.

- Motor switching function

Turning the Di terminal ON and OFF switches between parameters specified for the 1st motor and those for the 2nd motor. This further broadens the range of applications.

- Motor auto-tuning

The auto-tuning function enables the dynamic torque vector control, automatic energy saving operation, and other advanced motor controls to be applied also to non-Fuji general purpose motors.

- Long-life DC link bus capacitors, control printed circuit board capacitors and cooling fans adopted

- Optional USB-equipped remote keypad

Data copying and connection to FRENIC Loader are easy.

- Permanent magnet synchronous motor (PMSM) supported

A PMSM is more efficient than an induction motor (IM) so that further energy saving can be achieved.

- Available capacity range up to 15 kW (20 HP)

The capacity range has been spread.

## Optimum performance for traversing conveyors

- High starting torque, at 150% or more

Equipped with Fuji's original dynamic torque-vector control system and the automatic torque boost function, these inverters ensure consistent and powerful operation (when automatic torque boost and slip compensation control are ON and start frequency is set at 3 Hz).

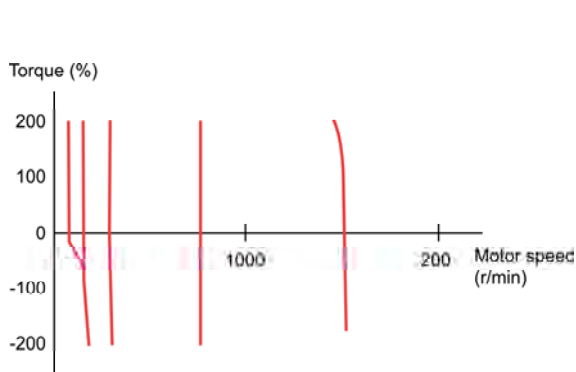
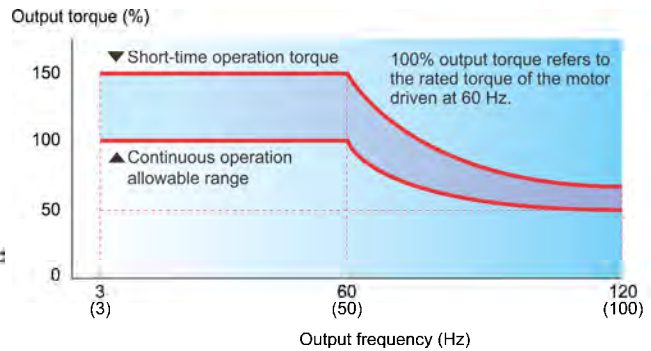

Figure 1.1 Torque Characteristics Data (Dynamic torque vector control: ON)



\* The above graph shows an example of torque characteristics obtained when FRENIC-Mini is combined one-to-one with Fuji standard three-phase motor (8-type series: 4 poles).

Figure 1.2 Example of Output Torque Characteristics

- Braking resistor connectable to the inverter

FRENIC-Mini series of inverters features a built-in braking transistor (for inverters of 0.4 kW (1/2 HP) or larger), which makes it possible for an optional braking resistor to be connected to increase the regenerative braking ability for conveyance and transportation machinery that requires strong braking power.

- Trip-free operation

The remarkably improved current limiting function (stall prevention) ensures trip-free operation even for impact loads.

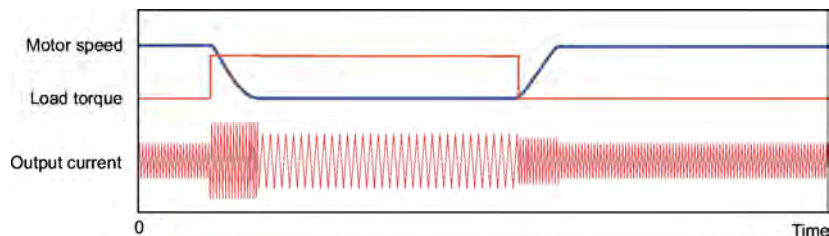

Figure 1.3 Example of Response for Impact Load Torque

- Stable operation even for a step load

The slip compensation function ensures stable operation even when the motor load fluctuates (step load).

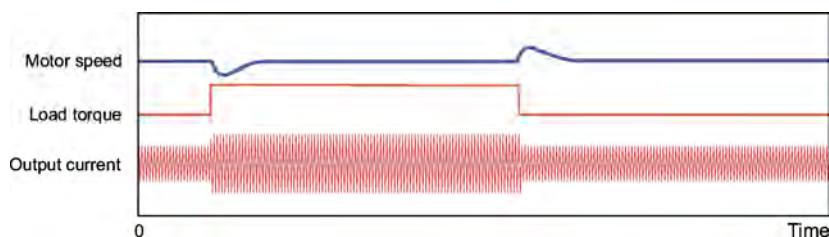

Figure 1.4 Example of Response for Step Load Torque (Refer to the note in Figure 1.2 for the test configuration.)

- Inclusion of a brake signal makes it even more convenient

#### At brake release time

After the motor runs, the inverter detects torque generation and outputs signals.

#### At brake application time

Brake application that matches the timing can be done, so mechanical brake wear is reduced.

- Tripless deceleration by automatic deceleration control

The inverter controls the energy level generated and the deceleration time to decelerate to stop the motor without tripping due to overvoltage.

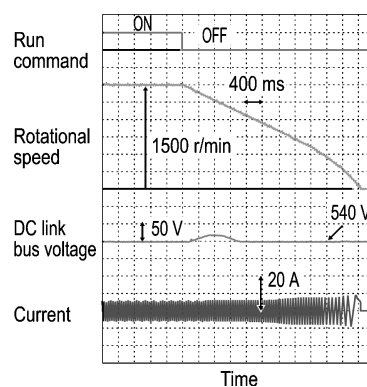

Figure 1.5

## Default functions for fans and pumps

- Automatic energy-saving function provided as standard

To minimize the total loss (motor loss plus inverter loss), rather than just the motor loss as in the predecessor models, FRENIC-Mini saves even more power when used with fans or pumps.

 Refer to Chapter 4, Section 4.7 "Drive Command Controller" for details.

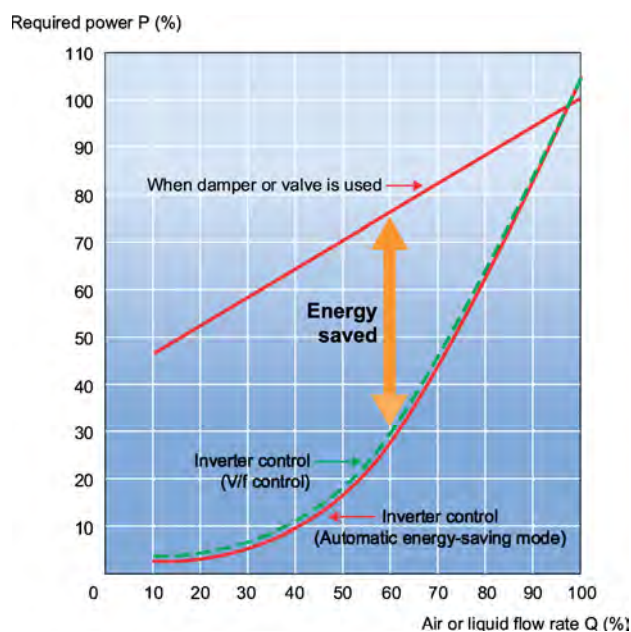

\* Energy savings vary depending on the motor characteristics.

Figure 1.6 Example of Energy Savings

- PID control function

Permits motor operation while controlling temperature, pressure, or flow rate without using an external device such as a temperature regulator. Under the constant pump discharge pressure control, the slow flowrate stop function is available.

 Refer to Chapter 4, Section 4.8 "PID Frequency Command Generator" for details.

- Cooling fan ON/OFF control function

The inverter's cooling fan can be turned off while the fan or pump is stopped for noise reduction and energy savings.

## The ideal functions to serve a multiplicity of needs for small-capacity inverters

- Compatible with a wide range of frequency settings

You can select the optimum frequency setting method that matches your machine or equipment via the keypad (▲/▼ keys or potentiometer), analog input (4 to 20 mA, 0 to 20 mA, 0 to +10 V, 0 to +5 V, 1 to 5 V), 16 multistep speed settings (0 to 15 steps) or via RS-485 communications.

- A transistor output is provided

This enables an overload early warning, lifetime forecast or other information signals to be output during operation.

 Refer to function code E20 in Chapter 9, Section 9.2.2 "E codes (Extension terminal functions)."

- High output frequency - up to 400 Hz

The inverter can be used with equipment such as centrifugal separators that require a high motor speed. In this case, you need to check whether the machine operation in combination with the motor is compatible or not.

- Three points can be set for a non-linear V/f pattern.

The addition of an extra point (total 3 points) for the non-linear V/f pattern, which can be set as desired, improves the FRENIC-Mini's drive capability, because the V/f pattern can be adjusted to match a wider application area.

 Refer to Chapter 4, Section 4.7 "Drive Command Controller" for details.

## Compact size

- Side-by-side mounting

More than one FRENIC-Mini inverter can be mounted side-by-side without any gap inside your system control panel, thereby reducing the amount of space required for installation. (Ambient temperature: 40°C (104°F) or lower)



Unit: mm (inch)

(Example: Inverters of 3-phase 200 V, 0.75 kW (1 HP) or less)



- External dimensions compatible with Fuji FVR-C11S series, externals compatible with original FRENIC-Mini series (FRN□□□□C1□-□□)

The external differences (improved points) from the conventional FRN□□□□C1□-□□ are as follows.

Screw added to the control circuit terminal block cover, which prevents the cover from coming off due to vibration or unexpected incident.

Control circuit terminal block using commonly used slotted screws instead of Phillips-head ones, which standardizes tools.

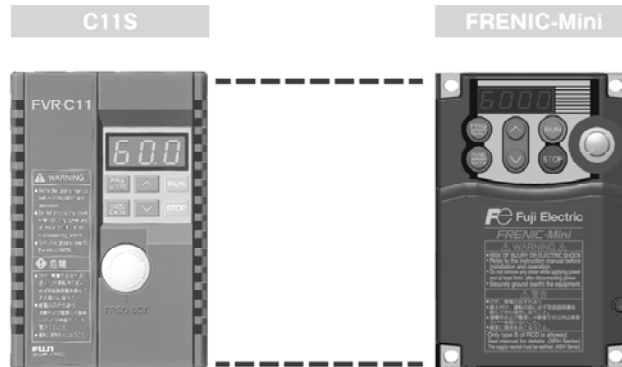

## Simplified operation and wiring

- Frequency setting potentiometer provided as standard

The frequency can be adjusted easily by hand.

- Easy-to-remove terminal block covers (for control circuit and main circuit) that are secured with a single screw.

As shown below, the terminal block covers for the control circuit and main circuit can be removed easily by removing the single screw from the control circuit terminal block cover.

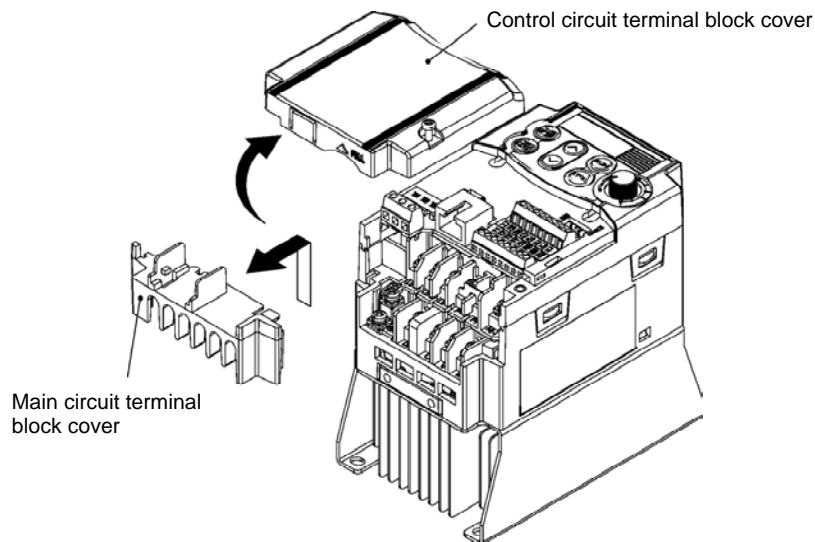

- LED monitor on the keypad displaying all types of data

You can access and monitor all types of inverter's data and information including output frequency, reference frequency, load shaft speed, output current, output voltage, alarm history, input power etc. using built-in keypad with LED.

 Refer to Chapter 3, "OPERATION USING THE KEYPAD."



- Menu mode accessible from the keypad

You can easily access the menu mode including "Data setting," "Data checking," "Drive monitoring," "I/O checking," "Maintenance information," and "Alarm information."

 Refer to Chapter 3, "OPERATION USING THE KEYPAD."

## Maintenance

FRENIC-Mini series features the following facilities useful for maintenance.

 Refer to Chapter 3, Section 3.3.5 "Reading Maintenance Information" and the FRENIC-Mini Instruction Manual, Chapter 7 "MAINTENANCE AND INSPECTION" for details.

- The lifetime of the DC link bus capacitor (reservoir capacitor) can be estimated

The capacitor's condition compared with its initial state can be confirmed.

- Recording and displaying of cumulative running time of the inverter

The inverter records and displays the accumulated running time of the inverter itself, the printed circuit board and cooling fan.

- Displaying Information that contributes to equipment maintenance

In addition to inverter maintenance information, the inverter displays data that also take equipment maintenance into consideration.

Item	Purpose
Motor cumulative running time (hr)	The actual cumulative running time of the equipment (motor) using the inverter is calculated. <Example of use> If the inverter is used to control a fan, this information is an indication of the timing for replacing the belt that is used on the pulleys.
Number of starts (times)	The number of the inverter start and stop times can be counted. <Example of use> The number of equipment start and stop times is recorded, so this information can be used as a guideline for parts replacement timing in equipment in which starting and stopping puts a heavy load on the machinery.

- Alarm history for up to 4 latest alarms

The inverter records detailed information for up to 4 alarms that occurred most recently, which can also be displayed on the LED.

 Refer to Chapter 3, Section 3.3.6 "Reading alarm information."

- Lifetime forecast signal via transistor output

This signal is output when the reservoir capacitor in the DC link bus, the electrolytic capacitors on the printed circuit board, or the cooling fans have been nearing the end of their service life.

 Refer to function code E20 in Chapter 9, Section 9.2.2 "E codes (Extension terminal functions)" for details.

## Interface for peripheral devices and comprehensive protective functions

- All models are equipped with an inrush current suppression circuit.

FRENIC-Mini series features an inrush current suppression circuit as standard in all models to reduce the cost of peripheral devices such as input magnetic contactor.

- Terminals for a DC reactor (DCR) provided as standard

Terminals for connection of a DCR, which are necessary for suppressing harmonics, are provided as standard in all models.

- Input/output phase loss protective function

FRENIC-Mini series can detect output phase loss at all times during starting and running. This feature assists you for keeping operation of your system stable.

- Switchable sink/source

The input/output mode (sink/source) of the digital input terminals can be switched by means of an internal jumper switch. No engineering change is required in other control devices including PLC.

- Motor can be protected by a PTC thermistor

The motor is protected by PTC (Positive Temperature Coefficient) thermistor which detects the motor's temperature and stops the inverter before the motor is overheated.

## Flexible through options

- Function code copy function

The optional remote keypad includes a built-in copy facility, so you can copy function code data set in a source inverter and duplicate it into a destination inverter.

- Inverter support software FRENIC Loader available

The inverter support loader program (Windows-based), which simplifies the configuration of function codes, is available as a free-of-charge option. It can be downloaded from our Website.

 Refer to Chapter 5, "RUNNING THROUGH RS-485 COMMUNICATION" for details.

---

- **Optional USB-equipped remote keypad (Available soon)**

A variety of data about the inverter unit can be saved in the keypad memory, allowing you to check the information in any place.

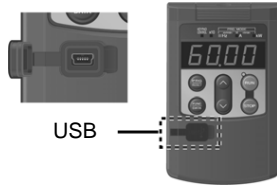

<Example of use in the office>



#### Features

1. The keypad can be directly connected to a computer through a commercial USB cable (mini B) without using a converter. The computer can be connected online with the inverter.
2. With the FRENIC Loader, the inverter can support the following functions (1) to (4).
  - (1) Editing, comparing, and copying the function code data
  - (2) Real-time operation monitor
  - (3) Trouble history (indicating the latest four troubles)
  - (4) Maintenance information

Data can be transferred from the USB port of the keypad directly to the computer (FRENIC Loader) at the site of production.

Periodical collection of life information can be carried out efficiently.

< Example of use at the site of production >



- **Mounting on DIN rail**

Using the rail-mounting base (option), the inverter can easily be mounted on a DIN rail (35 mm wide).

 Refer to Chapter 6, "SELECTING PERIPHERAL EQUIPMENT" for details.

- **Easy replacement of older models with new ones**

Using the mounting adapter (option) makes it possible to mount the latest models without drilling any additional holes.

 Refer to Chapter 6, "SELECTING PERIPHERAL EQUIPMENT" for details.

- Remote operation

Using the remote keypad (option) together with remote operation extension cable enables you to easily operate the inverter from a remote location.



Refer to Chapter 5, "RUNNING THROUGH RS-485 COMMUNICATION" and Chapter 6, "SELECTING PERIPHERAL EQUIPMENT" for details.

## Wide variations

The wide range of models available in the FRENIC-Mini series of inverters is certain to flexibly meet your various system needs.

- Three-phase 200/230 V series; 0.1 to 15 kW (1/8 to 20 HP)
- Three-phase 400/460 V series; 0.4 to 15 kW (1/2 to 20 HP)
- Single-phase 200/230 V series; 0.1 to 2.2 kW (1/8 to 3 HP)
- Single-phase 115 V series; 0.1 to 0.75 kW (1/8 to 1 HP)
- Model with a built-in EMC filter is available on order



Refer to Chapter 8, "SPECIFICATIONS" for details.

## Global products

The FRENIC-Mini series of inverters is designed for use in global market in conformity with the global standards listed below.

- All standard models conform to the EC Directive (CE Marking), UL standards (UL-Listed) and Canadian standards (cUL-Listed).

All standard FRENIC-Mini inverters conform to European and North American/Canadian standards, enabling standardization of the specifications for machines and equipment used at home and abroad.

- If a model with a built-in EMC filter is used, the model conforms to the European EMC Directive.

Europe

EC Directives (CE marking)



North America/Canada

UL standard (cUL certification)



## 1.2 Control System

This section gives you a general overview of inverter control systems and features specific to the FRENIC-Mini series of inverters.

As shown in Figure 1.8, single- or three-phase commercial power is converted to DC power in the converter section, which is then used to charge the capacitor on the DC link bus. According to control commands or signals generated in the control logic, the inverter modulates the electricity charged in the capacitor to PWM (Pulse Width Modulation) format and feeds the output to the motor. The modulation frequency is called "carrier frequency." As shown in Figure 1.7, the voltage waveform of the modulated power source produces pulse train with positive and negative polarity synchronized with the inverter's output command frequency. The inverter feeds the produced output as drive power with sinusoidal current waveform like that of ordinary commercial power lines.

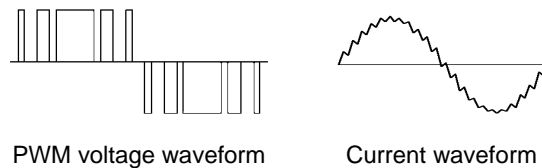

Figure 1.7 Output Voltage and Current Waveform of the Inverter

For the reference frequency given in the control logic, the accelerator/decelerator processor calculates the acceleration/deceleration rate required by run/stop control of the motor and transfers the calculated results to the 3-phase voltage command processor directly or via the V/f pattern generator.

 Refer to Chapter 4, Section 4.7 "Drive Command Controller" for details.

The FRENIC-Mini series changes the voltage control from the "Simplified Torque-Vector Control" using a magnetic flux estimator in conventional inverter series, to the Dynamic Torque Vector Control adopted in upper inverter series. Accordingly, the FRENIC-Mini series assures high start torque that the conventional series cannot obtain, broadening the range of applications.

The control logic section, which is the very brain of the inverter, allows you to customize the inverter's driving patterns using the function code settings.

 Refer to Chapter 4 "BLOCK DIAGRAMS FOR CONTROL LOGIC" for details.

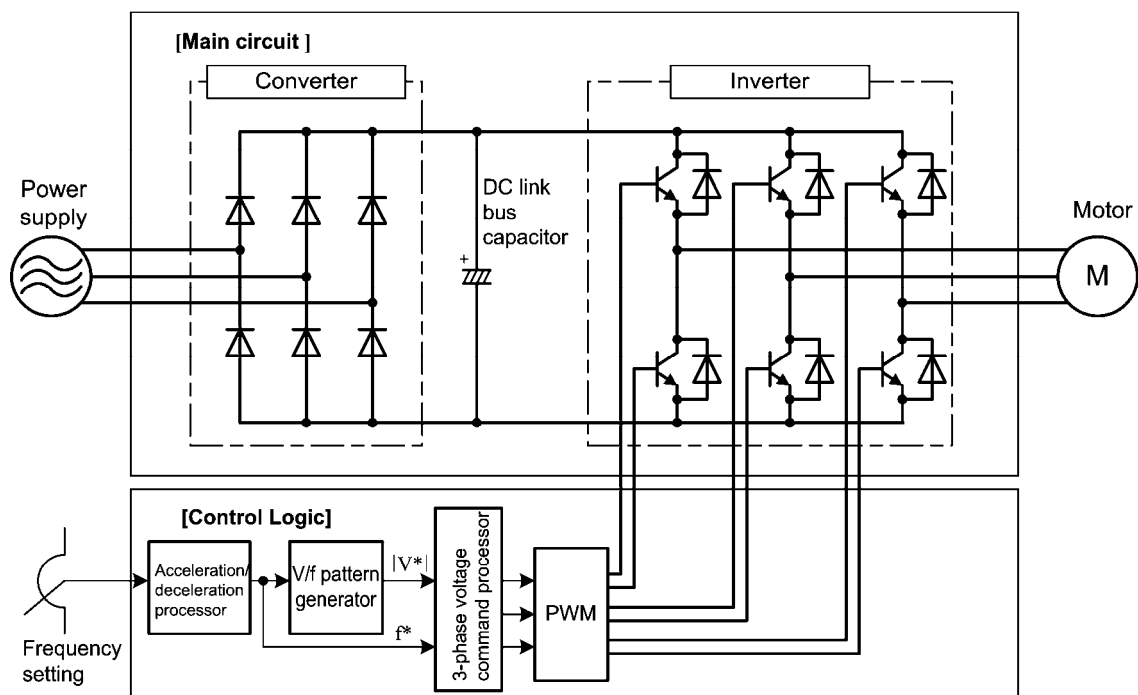

Figure 1.8 Simplified Control System Diagram of FRENIC-Mini

## 1.3 Recommended Configuration

To control a motor with an inverter correctly, you should consider the rated capacity of both the motor and the inverter and ensure that the combination matches the specifications of the machine or system to be used. Refer to Chapter 7, "SELECTING OPTIMAL MOTOR AND INVERTER CAPACITIES" for details.

After selecting the rated capacity, select appropriate peripheral equipment for the inverter, then connect them to the inverter.

Refer to Chapter 6, "SELECTING PERIPHERAL EQUIPMENT" and Chapter 8, Section 8.7 "Connection Diagrams" for details on the selection and connection of peripheral equipment.

Figure 1.9 shows the recommended configuration for an inverter and peripheral equipment.

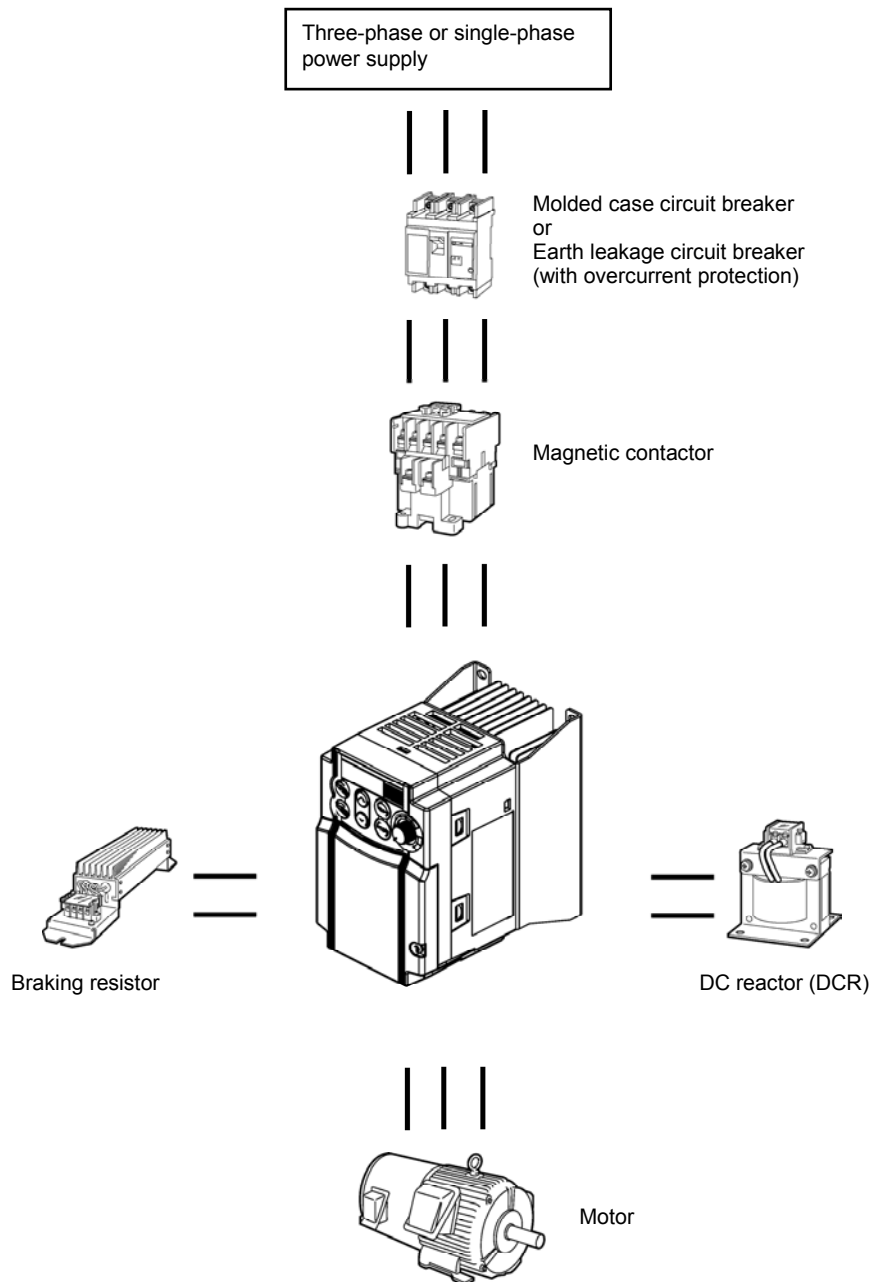

Figure 1.9 Recommended Configuration Diagram





---

## Chapter 2

# PARTS NAMES AND FUNCTIONS

This chapter contains external views of the FRENIC-Mini series and an overview of terminal blocks, including a description of the 7-segment LED monitor and keys on the keypad.

### Contents

2.1	External View and Terminal Blocks.....	2-1
2.2	Names and Functions of Keypad Components .....	2-2



## 2.1 External View and Terminal Blocks

(1) External view

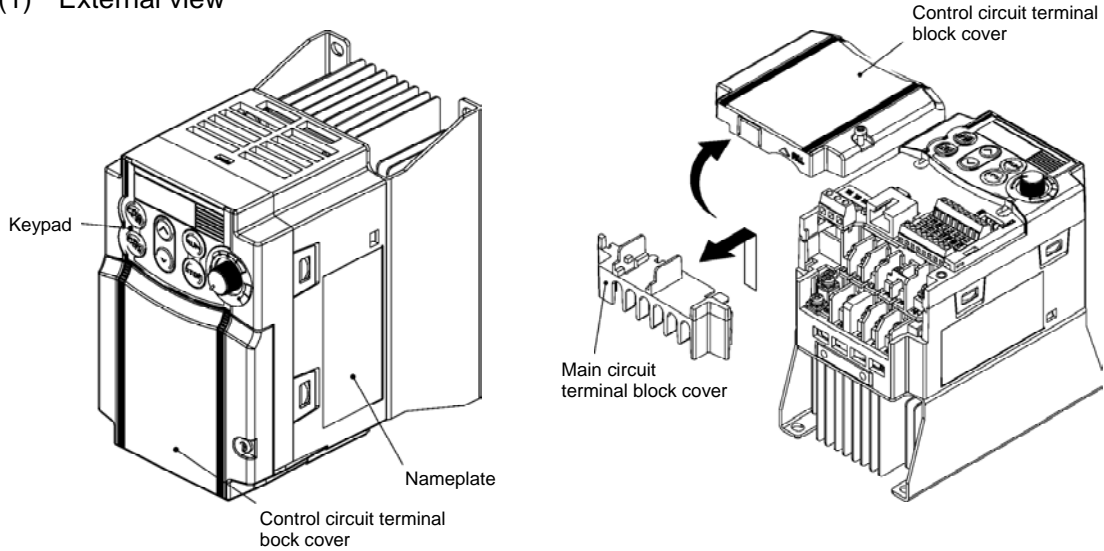

(2) Wiring section

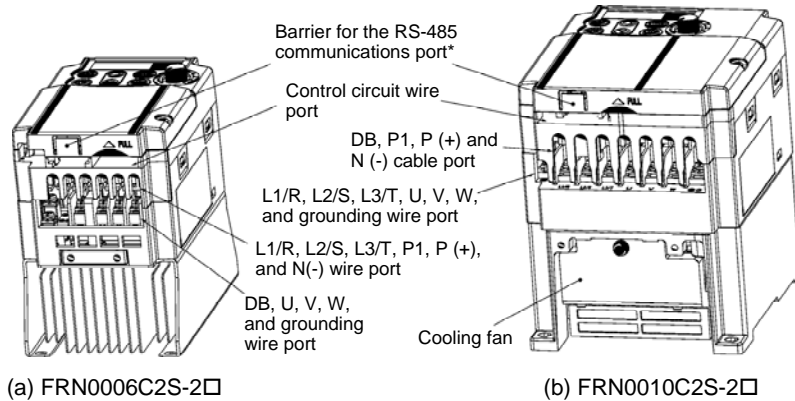

(a) FRN0006C2S-2□

(b) FRN0010C2S-2□

(\*When connecting the RS-485 communications cable, remove the control circuit terminal block cover and snip off the barrier provided in it using nippers.)

Note: A box (□) in model names replaces A, C, E, or U depending on shipping destination.

Figure 2.1 External View of FRENIC-Mini

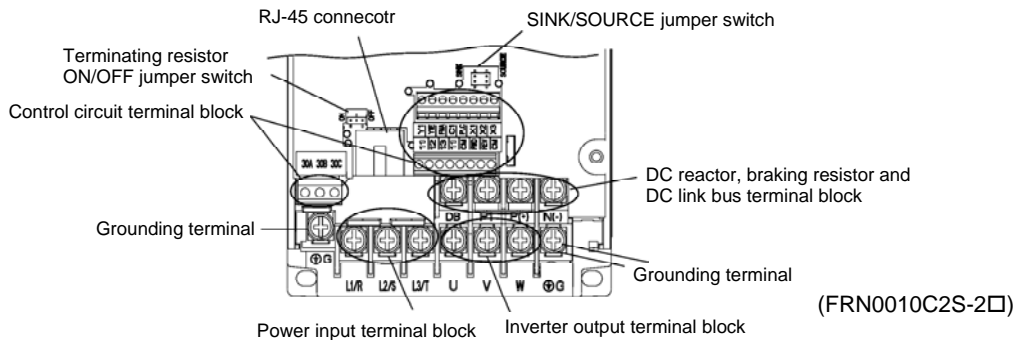

(FRN0010C2S-2□)

Figure 2.2 Enlarged View of Terminal Blocks

The above figures show three-phase power source models. The terminal allocation of the power input terminals L1/R, L2/S, L3/T, and grounding terminals for single-phase models differs from that shown in above figures.

Refer to Chapter 8 "SPECIFICATIONS" for details on terminal functions, allocation and connection and to Chapter 6, Section 6.2.1 "Recommended wires" when selecting wires.

For details on the keys and their functions, refer to Section 2.2 "LED Monitor, Potentiometer and Keys on the Keypad." For details on keying operation and function code setting, refer to Chapter 3 "OPERATION USING THE KEYPAD."

## 2.2 Names and Functions of Keypad Components

As shown at the right, the keypad consists of a four-digit, 7-segment LED monitor, a potentiometer (POT), and six keys.

The keypad allows you to run and stop the motor, monitor running status, configure the function code data, check I/O signal states, and display maintenance information and alarm information.

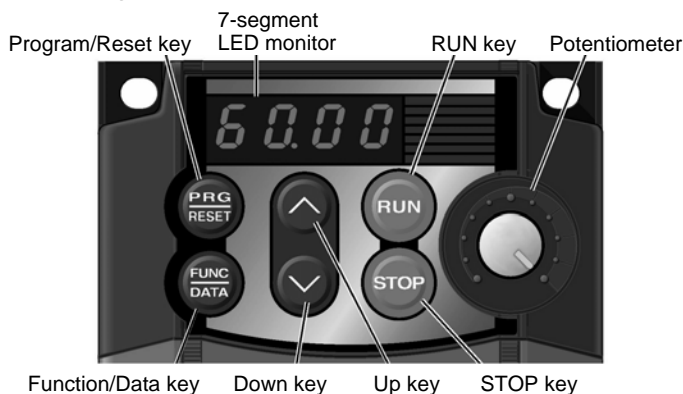

Figure 2.3 Keypad

Table 2.1 Overview of Keypad Functions

Monitor, Potentiometer and Keys	Functions
	Four-digit, 7-segment LED monitor which displays the running status, data settings, and alarm status of the inverter according to the operation modes*. In Running mode, the monitor displays running status information (e.g., output frequency, current, and voltage). In Programming mode, it displays menus, function codes and their data. In Alarm mode, it displays an alarm code which identifies the error factor if the protective function is activated.
	Potentiometer (POT) which is used to manually set frequency, auxiliary frequencies 1 and 2 or PID process command.
	RUN key. Press this key to run the motor.
	STOP key. Press this key to stop the motor.
	UP/DOWN keys. Press these keys to select the setting items and change the function data displayed on the LED monitor.
	Program/Reset key. Press this key to switch the operation modes* of the inverter. Pressing this key in Running mode switches the inverter to Programming mode and vice versa. In Alarm mode, pressing this key after removing the error factor will switch the inverter to Running mode.
	Function/Data key. Pressing this key in Running mode switches the information displayed (output frequency (Hz), current (Amps) or voltage (V)). Pressing this key in Programming mode displays the function code and sets the data entered using  /  keys or the POT. Pressing this key in Alarm mode displays information concerning the alarm code currently displayed on the LED monitor.

\* FRENIC-Mini features three operation modes--Running, Programming, and Alarm modes. Refer to Chapter 3, Section 3.1 "Overview of Operation Modes."

■ LED monitor

In Running mode, the LED monitor displays running status information (output frequency, current or voltage); in Programming mode, it displays menus, function codes and their data; in Alarm mode, it displays an alarm code which identifies the error factor if the protective function is activated.

If one of LED4 through LED1 is blinking, it means that the cursor is at this digit, allowing you to change it.

If the decimal point of LED1 is blinking, it means that the currently displayed data is a PID process command, not the frequency data usually displayed.

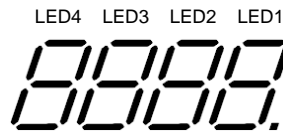

Figure 2.4 7-Segment LED Monitor

Table 2.2 Alphanumeric Characters on the LED Monitor

Character	7-segment	Character	7-segment	Character	7-segment	Character	7-segment
0	0	9	9	i	,	r	r
1	1	A	A	J	∟	S	5
2	2	b	b	K	-	T	-
3	3	C	C	L	L	u	-
4	4	d	d	M	-	V	U
5	5	E	E	n	n	W	-
6	6	F	F	o	o	X	-
7	7	G	G	P	P	y	Y
8	8	H	H	q	q	Z	-
Special characters and symbols (numbers with decimal point, minus and underline)							
0. - 9.	0. - 9.	-	-	-	-		

■ Repeat function of  $\uparrow$  /  $\downarrow$  keys

$\uparrow$  /  $\downarrow$  keys have a repeat function which helps you change displayed data speedily as follows:

Usually you press  $\uparrow$  /  $\downarrow$  keys once to increase or decrease the displayed value by 1, respectively.





If you hold down either key so as to activate the repeat function, the displayed value will keep changing in steps of 1 speedily. Note that when changing some function code data during running of the inverter (not always possible), the displayed data will keep changing more slowly. This is to ensure safe and stable operation.







■ Continuous holding-down function for Program/Reset  key

Holding down the  key longer (approx. one second or longer) moves the cursor on the LED monitor. In Running mode, the cursor moves along digits; in Programming mode, it moves not only along digits but to the next function code.

■ Simultaneous keying

Simultaneous keying means depressing two keys at the same time (expressed by "+"). FRENIC-Mini supports simultaneous keying as listed below.

(For example, the expression " +  keys" stands for pressing the  key while holding down the  key.)

Operation modes	Simultaneous keying	Used to:
Running mode	 +  keys	Control entry to/exit from jogging operation.
Programming mode	 +  keys	Change special function code data. (Refer to function codes F00, H03, H45 and H97 in Chapter 9 "FUNCTION CODES.")
Alarm mode	 +  keys	Switch to Programming mode without clearing alarms.

■ About changing of function code data

The function code data can be changed only when the data value displayed on the LED monitor is flashing.

When the data value is lit, no change is allowed. To change the data, stop the inverter or disable the data protection.

---

## Chapter 3

# OPERATION USING THE KEYPAD

This chapter describes inverter operation using the keypad. The inverter features three operation modes (Running, Programming and Alarm modes) which enable you to run and stop the motor, monitor running status, set function code data, display running information required for maintenance, and display alarm data.

### Contents

3.1	Overview of Operation Modes.....	3-1
3.2	Running Mode .....	3-3
3.2.1	Run/stop the motor.....	3-3
3.2.2	Set up the reference frequency and PID process command .....	3-3
3.2.3	Monitor the running status .....	3-5
3.2.4	Jog (inch) the motor .....	3-7
3.3	Programming Mode .....	3-8
3.3.1	Setting the function codes--"Data Setting".....	3-9
3.3.2	Checking changed function codes--"Data Checking" .....	3-13
3.3.3	Monitoring the running status--"Drive Monitoring" .....	3-14
3.3.4	Checking I/O signal status--"I/O Checking" .....	3-17
3.3.5	Reading maintenance information--"Maintenance Information" .....	3-21
3.3.6	Reading alarm information--"Alarm Information".....	3-24
3.4	Alarm Mode.....	3-28
3.4.1	Releasing the alarm and transferring the inverter to Running mode .....	3-28
3.4.2	Displaying the alarm history .....	3-28
3.4.3	Displaying the running information when an alarm occurs .....	3-29
3.4.4	Transferring to Programming mode .....	3-29





## 3.1 Overview of Operation Modes

FRENIC-Mini features the following three operation modes:

- **Running mode** : This mode allows you to enter run/stop commands in regular operation. You may also monitor the running status in realtime.
- **Programming mode** : This mode allows you to set function code data and check a variety of information relating to the inverter status and maintenance.
- **Alarm mode** : If an alarm occurs, the inverter automatically enters this Alarm mode in which the corresponding alarm code\* and its related information may be displayed on the LED monitor.

\* Alarm code: Shows the error factor that has activated the protective function. For details, refer to Chapter 8, Section 8.8 "Details of Protective Functions."

Figure 3.1 shows the status transition of the inverter between these three operation modes. If the inverter is turned ON, it automatically enters Running mode, making it possible to start or stop the motor.

To make the transition between those operation modes, you need to press the specified keys as shown below, except at the occurrence of an alarm. If an alarm occurs in Running mode, the inverter will automatically switch to Alarm mode.

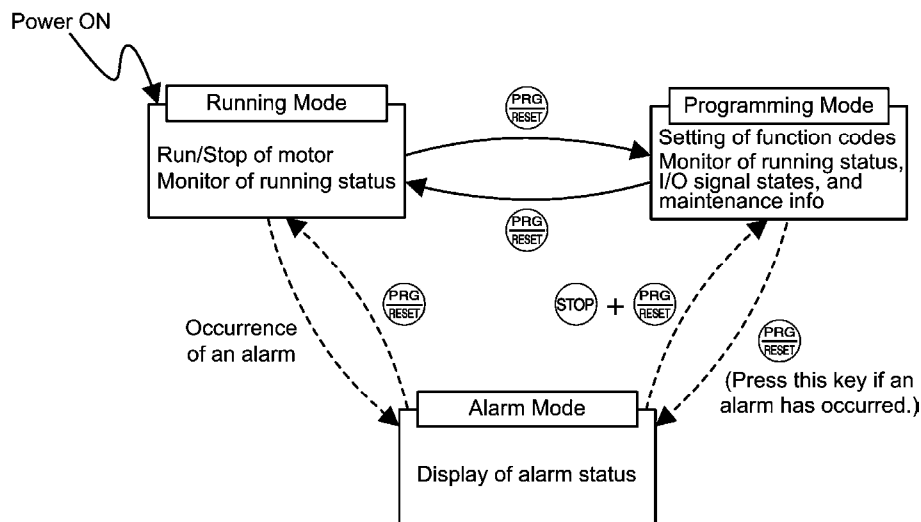
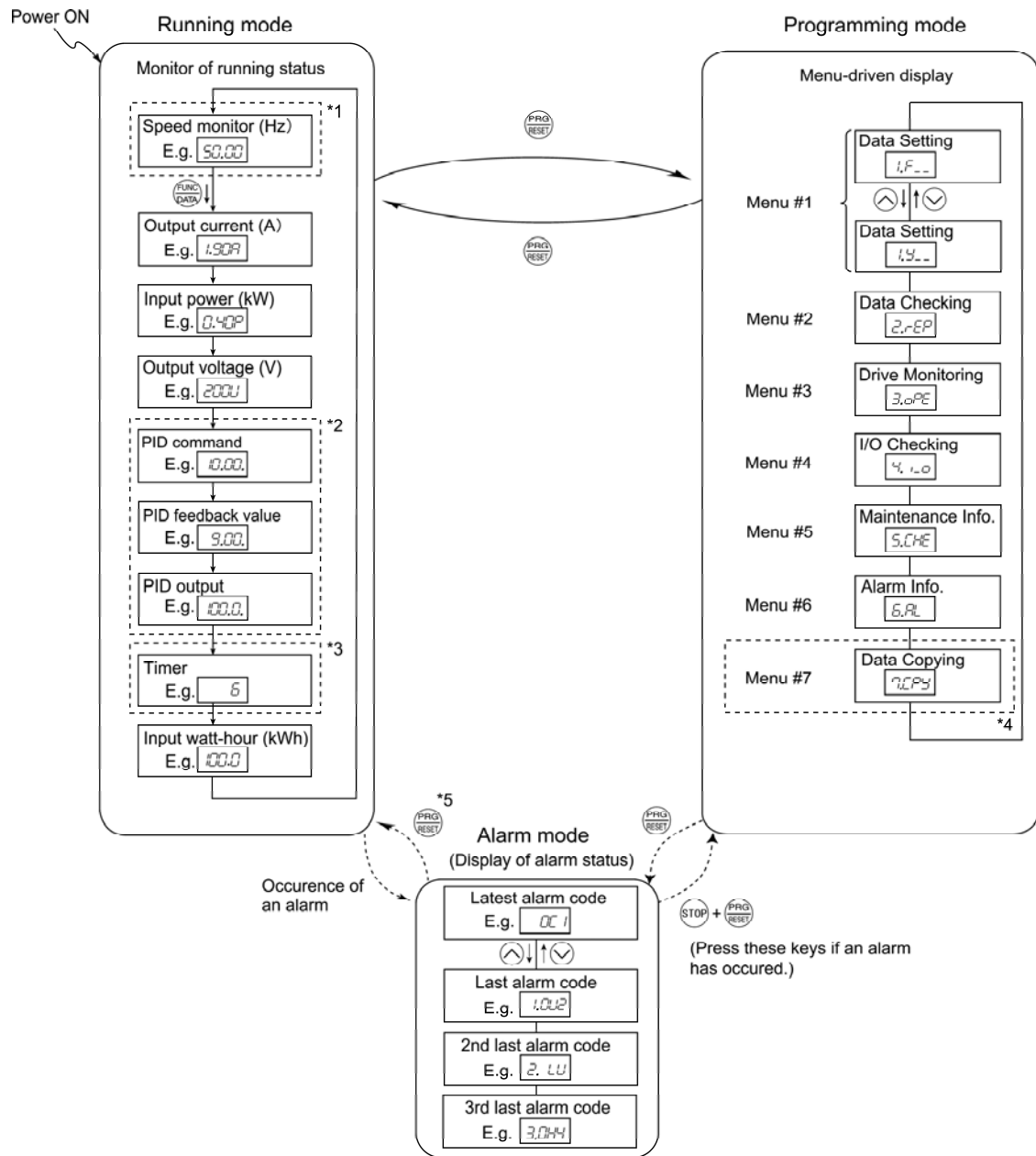

Figure 3.1 Status Transition between Operation Modes

The figure below shows the transition between the running status monitoring screens in Running mode, that between the menu screens in Programming mode, and that between the alarm code screens in Alarm mode.



- \*1 The speed monitor may display the output frequency (Hz), reference frequency (Hz), load shaft speed (r/min), line speed (m/min.), and constant feeding rate time (min.) which can be selected by setting up function code E48.
- \*2 These PID-related information will appear only when the inverter is under the PID control. (Refer to Section 3.2.2.)
- \*3 This appears only when timer operation is enabled by setting up function code C21. (Refer to Chapter 9, Section 9.2.3 "C codes (Control functions of frequency).")
- \*4 This appears only when the remote keypad (option) is connected with the inverter.



Figure 3.2 Basic Screen Transition in Each Operation Mode



## 3.2 Running Mode

If the inverter is turned ON, it automatically enters Running mode in which you may:



- (1) Run/stop the motor
- (2) Set up the reference frequency and PID process command
- (3) Monitor the running status (e.g., output frequency, output current)
- (4) Jog (inch) the motor

### 3.2.1 Run/stop the motor

By factory default, pressing the  key starts running the motor in the forward direction and pressing the  key brings the motor to a decelerated stop. The  key is enabled only in Running mode.

Changing function code F02 data makes it possible to run the motor in the reverse direction by pressing the  key, determine the motor rotational direction by entering input signals to the terminals, and control the motor by pressing  /  keys.

### 3.2.2 Set up the reference frequency and PID process command



By using the potentiometer and  /  keys on the keypad, you may set up the desired reference frequency and PID process command. It is also possible to set up the reference frequency as frequency, load shaft speed, line speed, and constant feeding rate time by setting function code E48.





#### ■ Setting up the reference frequency

##### With the potentiometer on the keypad (factory default)



If you set function code F01 to "4: Potentiometer on the keypad" (factory default) and select frequency setting-1 with function codes E01 through E03 (Hz2/Hz1 = OFF), then the potentiometer becomes enabled to set up the reference frequency. Setting function code C30 to "4: Potentiometer on the keypad" and selecting frequency setting-2 (Hz2/Hz1 = ON) also produce the same effect.

##### With / keys

If you set function code F01 to "0: Keypad operation" and select frequency setting-1, then  /  keys become enabled to set up the reference frequency in Running mode. In any other operation modes, those keys remain disabled.



Pressing  /  keys calls up the reference frequency with the lowest digit blinking. Pressing  /  keys again makes it possible to change the reference frequency. The new setting will be saved internally. Even if the inverter is switched to any other frequency entry method and then returned to the keypad entry method, the setting will be retained.

Further, even turning OFF the inverter will automatically save the setting into the non-volatile memory. At the next time when the inverter is turned ON, the setting will become the default frequency.

If you set function code F01 to "0: Keypad operation" but do not select frequency setting-1, then  /  keys cannot be used for setting up the reference frequency. Pressing those keys will just display the currently selected reference frequency.





To set up the reference frequency from any other displayed items, it is dependent on function code E48 data (= 4, 5, or 6) "LED monitor details (Select speed monitor)" as listed in the following table.

E48 data "LED monitor details (Select speed monitor)"	Display of reference frequency	Conversion of displayed value
0: Output frequency (before slip compensation)	Frequency setting	
1: Output frequency (after slip compensation)	Frequency setting	
2: Reference frequency	Frequency setting	
4: Load shaft speed	Load shaft speed setting	Frequency setting x E50
5: Line speed	Line speed setting	Frequency setting x E50
6: Constant feeding rate time	Constant feeding rate time	$\frac{E50}{\text{Frequency setting} \times E39}$

 If you set function code C30 to "0: Keypad operation" and select frequency setting-2, then  /  keys become also enabled to set up the reference frequency.

### ■ Setting up the PID process command

To enable PID control, you need to set function code J01 to 1 or 2.



In the PID control mode, the items that can be set or checked with  /  keys are different from those under normal frequency control, depending upon the current LED monitor setting. If the LED monitor is set to the speed monitor (E43 = 0), you may access manual feed commands (Reference frequency) with  /  keys; if it is set to any other, you may access PID process commands with those keys.





 Refer to Chapter 4, Section 4.8 "PID Frequency Command Generator" for details on the PID control.

#### Setting the PID process command with the built-in potentiometer

Set function code E60 to "3: PID process command 1" and J02 to "1: PID process command 1." After that, selecting PID control remote process command enables you to set the PID process command using the built-in potentiometer.



#### Setting the PID process command with / keys

Set function code J02 to "0: Keypad operation" and set the LED monitor to the setting other than the speed monitor (E43 = 0) in Running mode. This makes it possible to set the PID process command using  /  keys. This setting is possible only in Running mode.

Pressing  /  keys displays the PID process command with the lowest digit blinking on the LED monitor. Pressing  /  keys again makes it possible to change the PID process command. Once the PID process command is modified, it will be saved internally. Even if the inverter is switched to any other PID process command entry method and then returned to the keypad entry method, the setting will be retained.

Further, even turning OFF the inverter will automatically save the setting into the non-volatile memory. At the next time when the inverter is turned ON, the setting will become the default PID process command.

Even if the PID process command is selected ((SS4) = ON) in the multistep frequency, it is still possible to set the process command using the keypad.

When function code J02 has been set to any value except 0, pressing  /  keys displays the PID process command currently selected (setting is not possible).

When the PID process command is displayed, the decimal point next to the lowest digit on the LED display blinks to discriminate it from the frequency setting.

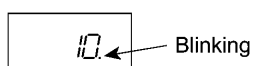



- When setting the frequency and others with  $\Delta$  /  $\nabla$  keys, the lowest digit on the display will blink. Change the setting, starting from the lowest digit and the cursor will move gradually to the next digit to be changed.
- When the data is to be changed rapidly, hold down the  $\text{PRG/RESET}$  key for 1 second or longer, and the blinking cursor will move to the next digit where the data can be changed (cursor movement).

### 3.2.3 Monitor the running status

In Running mode, the nine items listed below can be monitored. Immediately after the inverter is turned ON, the monitor item specified by function code E43 is displayed. Press the  $\text{FUNC/DATA}$  key to switch between monitor items.

Table 3.1 Monitor Items

Monitor Items	Display Sample on the LED monitor *1	Meaning of Displayed Value
Speed monitor (Hz, r/min, m/min, min)	50.00	Refer to Table 3.2.
Output current (A)	1.90A	Current output from the inverter in RMS
Input power (kW)	0.40P	Input power to the inverter
Output voltage (V) *2	200V	Voltage output from the inverter in RMS
PID command *3 *4	10.0.	(PID command or PID feedback value) $\times$ (PID display coefficient A - B) + B
PID feedback value *3 *5	9.0.	PID display coefficient A and B: Refer to function codes E40 and E41
PID output *3 *4	100.	PID output in %, assuming the maximum frequency (F03) as 100%
Timer (sec) *3	50	Remaining effective timer count
Input watt-hour	20.38	Display value = $\frac{\text{Input watt-hour (kWh)}}{100}$

- \*1 A display value 10000 or above cannot be displayed on the 4-digit LED monitor, so "[- -]" appears instead.
- \*2 When the LED monitor displays an output voltage, the 7-segment letter 'V' in the lowest digit stands for the unit of the voltage "V."
- \*3 These items appear only under PID control (J01 = 1 or 2).  
The timer (for timer operation) appears only when timer operation is enabled (C21 = 1).  
When the PID control or timer operation is disabled, "----" appears instead.
- \*4 When the LED monitor displays a PID command or its output amount, the dot (decimal point) attached to the lowest digit of the 7-segment letter blinks.
- \*5 When the LED monitor displays a PID feedback amount, the dot (decimal point) attached to the lowest digit of the 7-segment letter lights.

Figure 3.3 shows the procedure example for selecting the desired monitor item.

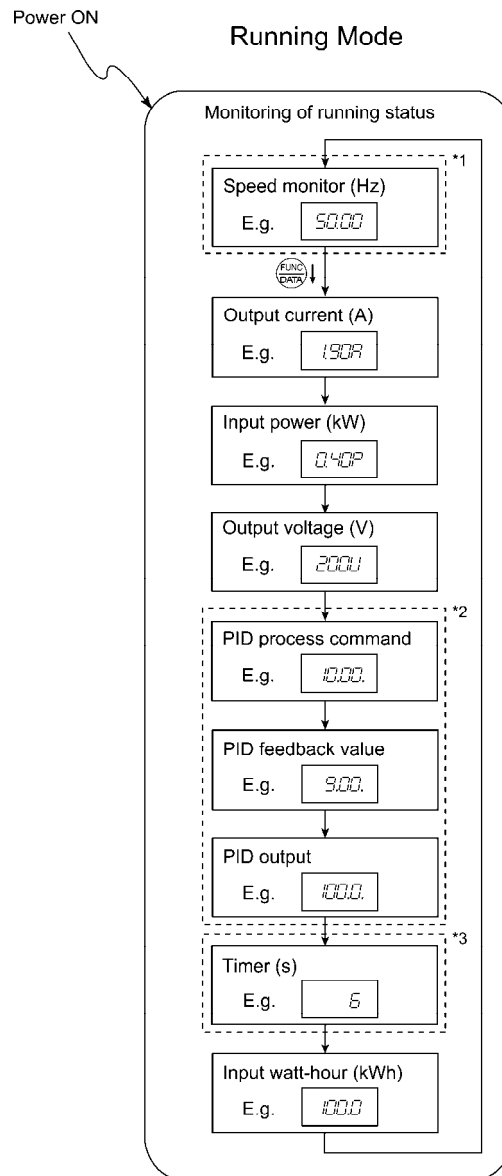

- \*1 The speed monitor may display the output frequency (Hz), reference frequency (Hz), load shaft speed (r/min), line speed (m/min.), and contrast feeding rate time (min.) which can be selected by setting up function code E48.
- \*2 These PID-related information will appear only when the inverter is under the PID control. (Refer to Section 3.2.2.)
- \*3 This will appear only when timer operation is enabled by setting up function code C21. (Refer to Chapter 9, Section 9.2.3 "C codes (Control functions of frequency).")

Figure 3.3 Monitor Item Selection Example



Table 3.2 lists the display items for the speed monitor that can be chosen with function code E48.



Table 3.2 Display Items on the Speed Monitor

Speed monitor items	Function code E48 data	Meaning of Displayed Value
Output frequency (before slip compensation) (Hz) (Factory default)	0	Pre-slip compensation frequency
Output frequency (after slip compensation) (Hz)	1	Frequency actually being outputted
Reference frequency (Hz)	2	Final reference frequency
Load shaft speed (r/min)	4	Display value = Output frequency (Hz) x E50*
Line speed (m/min)	5	Display value = Output frequency (Hz) x E50*
Constant feeding rate time (min)	6	Display value = $\frac{E50}{\text{Output frequency} \times E39}$ *

\* Output frequencies contained in these formulas are output frequencies before slip compensation.

### 3.2.4 Jog (inch) the motor



In Running mode, pressing  +  keys at the same time (simultaneous keying) can make the inverter ready for jogging. The  appears on the LED monitor.



To return the inverter from the ready-to-jog state to the usual running state, you need to press  +  keys simultaneously.

Using the external input signal command (JOG) also allows the transition between the ready-to-jog state and usual running state.

 Refer to function codes E01 to E03 in Chapter 9, Section 9.2.2 "E codes (Extension terminal functions)" for details.

During jogging, the jogging frequency (C20) and acceleration/deceleration time for jogging (H54) will apply. They are exclusively prepared for jogging and required to be set up individually.

When jogging the motor from the keypad, the inverter will only run while the  key is held down, and contrarily the moment the  key is released, the inverter will decelerate and stop the motor.

 **Note** The transition ( +  keys) between the ready-to-jog state and usual running state is enabled only when the inverter is not in operation.

### 3.3 Programming Mode

Pressing the  key in Running mode switches the inverter to Programming mode. This mode provides the following functions which can be easily selected with the menu-driven system.

- (1) Data setting (Menu #1)
- (2) Data checking (Menu #2)
- (3) Drive monitoring (Menu #3)
- (4) I/O checking (Menu #4)
- (5) Maintenance information (Menu #5)
- (6) Alarm information (Menu #6)
- (7) Data copying (Menu #7) (only when an option is mounted)

The table below lists the menus, letters that will appear on the LED monitor, and functions. The leftmost digit (numerals) of each letter string indicates the corresponding menu number and the remaining three digits indicate the menu contents.

When the inverter enters Programming mode from the second time on, the menu that was selected last in Programming mode will be displayed.

Table 3.3 Menus Available in Programming Mode

Menu	LED monitor shows:	Main functions	Refer to:
Menu #1 "Data setting"	<i>1F__</i>	F codes (Fundamental functions)	Selecting each of these function codes enables its data to be displayed/changed.
	<i>1E__</i>	E codes (Extension terminal functions)	
	<i>1C__</i>	C codes (Control functions of frequency)	
	<i>1P__</i>	P codes (Motor 1 parameters)	
	<i>1H__</i>	H codes (High performance functions)	
	<i>1A__</i>	A codes (Motor 2 parameters)	
	<i>1J__</i>	J codes (Application functions)	
	<i>1Y__</i>	y codes (Link functions)	
Menu #2 "Data checking"	<i>2rEP</i>	Displays only function codes that have been changed from their factory defaults. You may refer to or change those function codes data.	Section 3.3.2
Menu #3 "Drive monitoring"	<i>3oPE</i>	Displays the running information required for maintenance or test running.	Section 3.3.3
Menu #4 "I/O checking"	<i>4. I O</i>	Displays external I/O signal information.	Section 3.3.4
Menu #5 "Maintenance information"	<i>5. CHE</i>	Displays maintenance information including cumulative running time.	Section 3.3.5
Menu #6 "Alarm information"	<i>6. AL</i>	Displays the latest four alarm codes. You may refer to the running information at the time when the alarm occurred.	Section 3.3.6
Menu #7 "Data copying"	<i>7. CPY</i>	Allows you to read or write function code data, as well as verifying it.  NOTE: To use this function, a remote keypad (option) is required.	



### Limiting menus to be displayed

The menu-driven system has a limiter function (specified by function code E52) that limits menus to be displayed for the purpose of simple operation. The factory default is to display Menu #1 "Data setting" only, allowing no switching to any other menu.

Function Code E52 – Menu Display Mode for Keypad

Function code data (E52)	Menus selectable
0: Function code data setting mode	Menu #1 "Data setting" (factory default)
1: Function code data check mode	Menu #2 "Data checking"
2: Full-menu mode	Menu #1 through #6 (#7*)

\* Menu #7 appears only when the remote keypad (option) is mounted.



If the full-menu mode is selected, pressing the  $\wedge$  /  $\vee$  keys will cycle through menus. With the  $\text{FUNC DATA}$  key, you may select the desired menu. Once all of the menus have been cycled through, the display will return to the first menu.

### 3.3.1 Setting the function codes--"Data Setting"

Menu #1 "Data setting" in Programming mode allows you to set function codes for making the inverter functions match your needs.

The table below lists the function codes available in the FRENIC-Mini. The function codes are displayed on the LED monitor on the keypad as shown below.

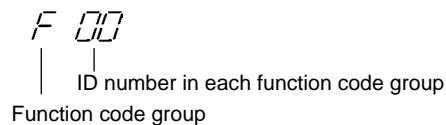

Table 3.4 List of FRENIC-Mini Function Codes





Function code group	Function code	Function	Description
F codes (Fundamental functions)	F00 to F51	Basic functions	To be used for basic motor running.
E codes (Extension terminal functions)	E01 to E99	Terminal functions	To be used to select the functions of the control circuit terminals. To be used to set functions related to the LED monitor display.
C codes (Control functions of frequency)	C01 to C52	Control functions	To be used to set application functions related to frequency settings.
P codes (Motor parameters)	P02 to P99	Motor 1 parameters	To be used to set specific parameters for the motor capacity, etc.
H codes (High performance functions)	H03 to H98	High level functions	To be used for high added value functions and complicated control, etc.
A codes (Alternative motor functions)	A01 to A52	Motor 2 parameters	To be used to set specific parameters for the motor capacity, etc.
J codes (Application functions)	J01 to J72	Application functions	To be used for PID control and brake signals.
y codes (Link functions)	y01 to y99	Link functions	To be used for communications.



Refer to Chapter 9 "FUNCTION CODES" for details on the function codes.

---

### **Function codes that require simultaneous keying**

To change data for function codes F00 (Data Protection) and H03 (Data Initialization), simultaneous keying operation is necessary-- +  keys or  +  keys. This prevents data from being lost by mistake.

### **Changing, validating, and saving of function code data during running**

Some function code data can be changed while the motor is running and some cannot. Further, amongst the function codes whose data can be changed while the motor is running, there are some for which the changes can be validated immediately and others for which they cannot. Refer to the "Change when running" column in Chapter 9, Section 9.1 "Function Code Tables."

Figure 3.4 shows the status transition for Menu #1 "Data setting" and Figure 3.5 shows an example of the function code data changing procedure.

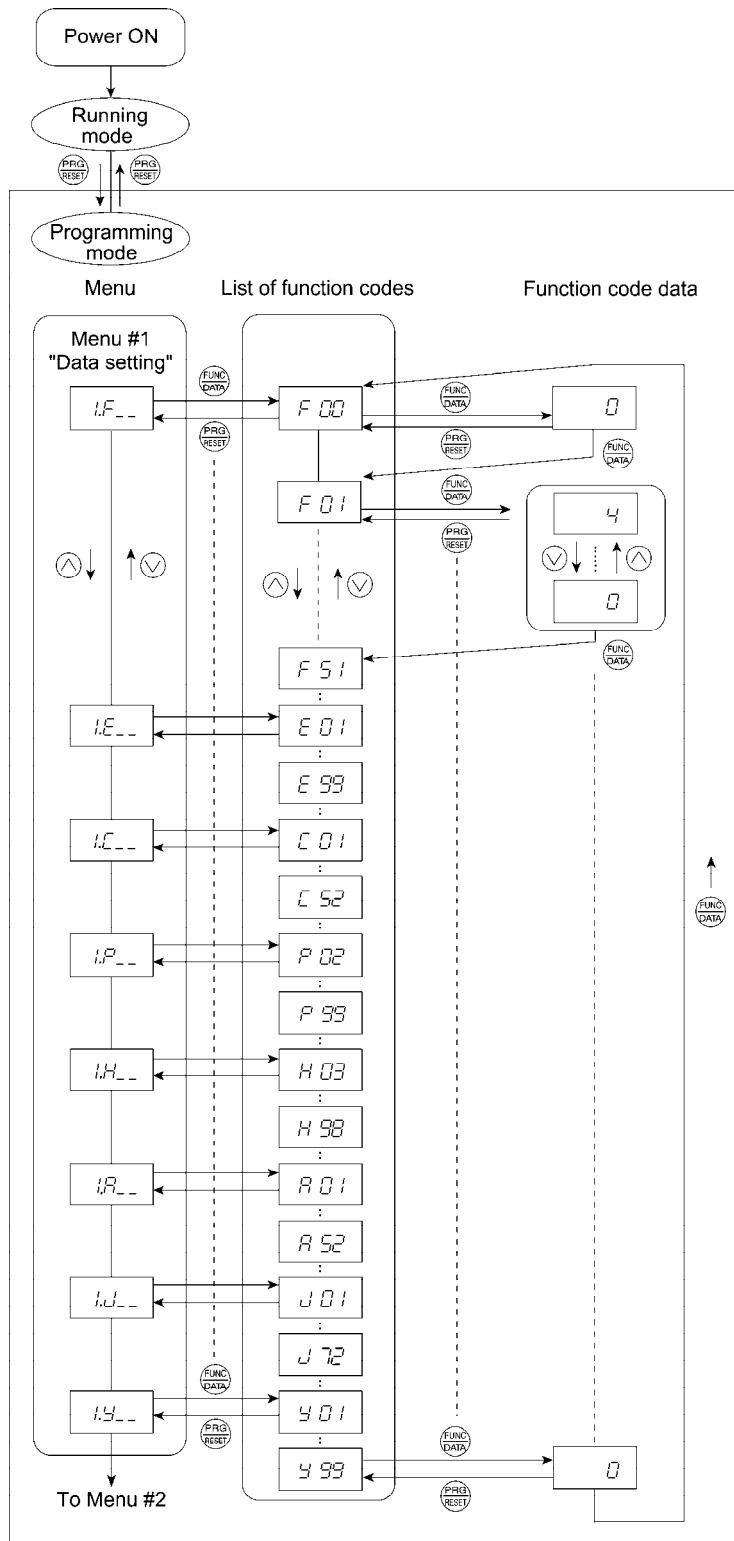

Figure 3.4 Status Transition Diagram for "Data Setting"

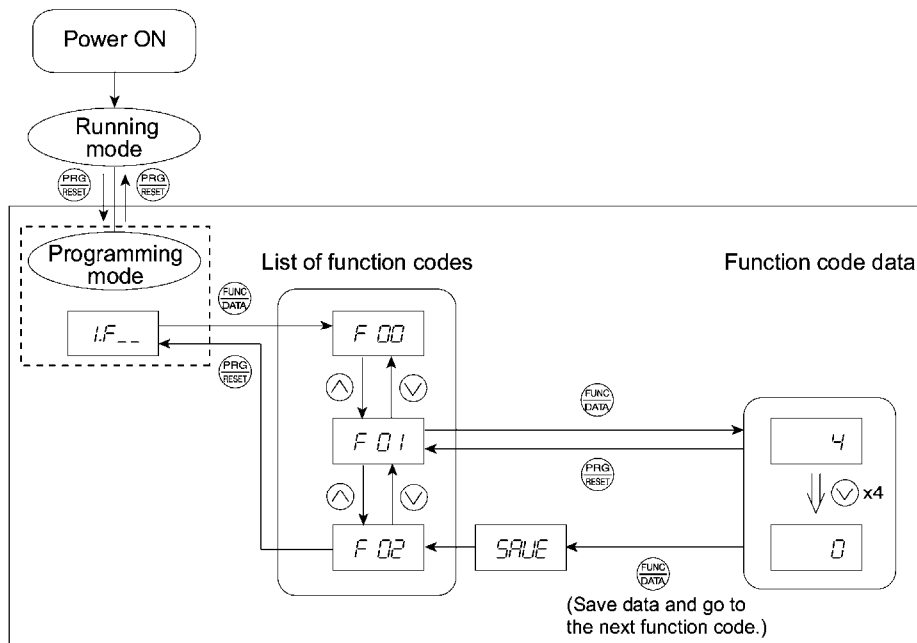

Figure 3.5 Example of Function Code Data Changing Procedure

### **Basic key operation**

This section will give a description of the basic key operation, following the example of the function code data changing procedure shown in Figure 3.5.

This example shows you how to change function code F01 data from the factory default of "Potentiometer operation on the keypad (F01 = 4)" to "∧/∇ keys operation (F01 = 0)."

- (1) With the menu displayed, use ∧/∇ keys to select the desired function code group. (In this example, select *i.F \_ \_*).
- (2) Press the key to display the function codes in the function code group selected in (1). (In this example, function code *F00* will appear.)

Even if the function code list for a particular function code group is displayed, it is possible to transfer the display to a different function code group using ∧/∇ keys.

- (3) Select the desired function code using ∧/∇ keys and press the key. (In this example, select function code *F01*.)

The data of this function code will appear. (In this example, data *4* of *F01* will appear.)

- (4) Change the function code data using ∧/∇ keys. (In this example, press the ∇ key four times to change data from *4* to *0*.)
- (5) Press the key to establish the function code data.

The *SAVE* will appear and the data will be saved in the non-volatile memory. The display will return to the function code list, then move to the next function code. (In this example, *F02*.)

Pressing the key before the key cancels the change made to the data. The data reverts to the previous value, the display returns to the function code list, and the original function code reappears.

- (6) Press the key to return to the menu from the function code list.



Tip

Cursor movement: You may move the cursor also when changing function code data in the same way as with the frequency settings. Refer to Section 3.2.2 "Set up the reference frequency and PID process command."

### 3.3.2 Checking changed function codes--"Data Checking"

Menu #2 "Data checking" in Programming mode allows you to check function code data that have been changed. Only data that has been changed from the factory defaults are displayed on the LED monitor. You may refer to the function code data and change again if necessary. Figure 3.6 shows the status transition diagram for "Data checking."

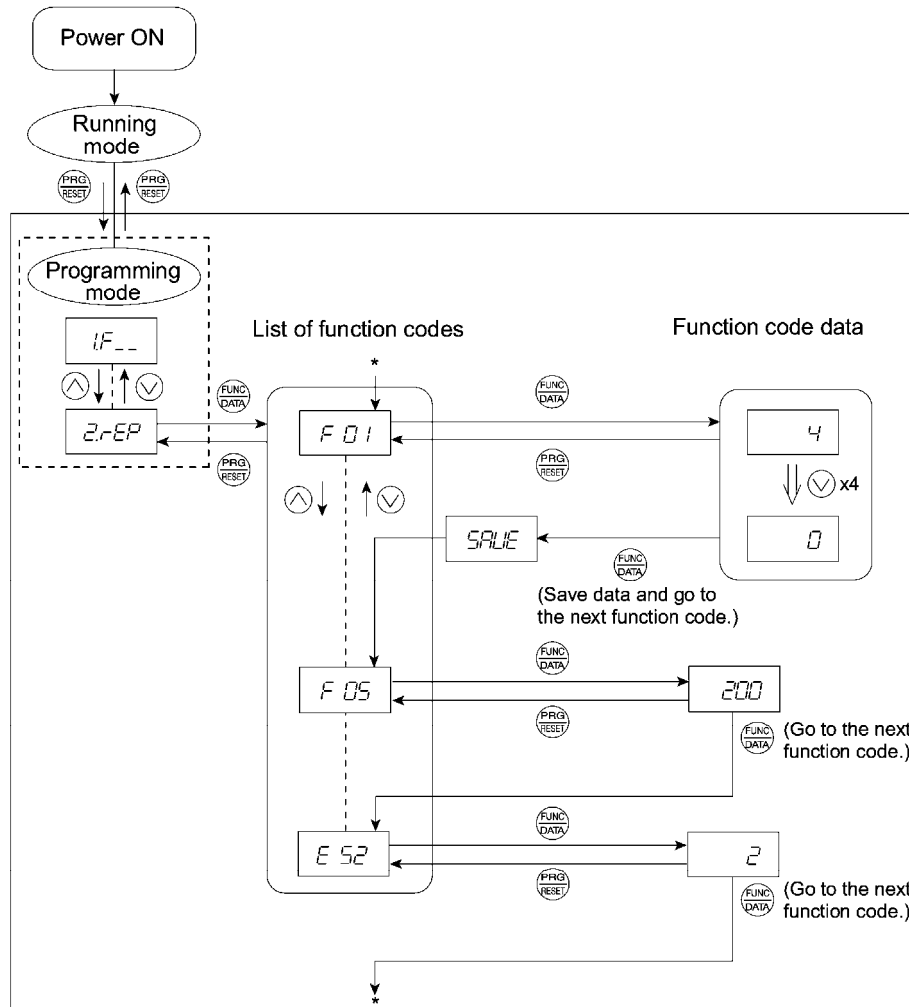



\* Pressing the  key when the *E 52* data is displayed will take you back to *F 01*.

Figure 3.6 Data Checking Status Transition Diagram (Changes made only to F01, F05, E52)

#### Basic key operation

The basic key operation is the same as for Menu #2 "Data setting."

 To monitor Menu #2 "Data checking," it is necessary to set function code E52 data to 1 (Function code data check mode) or 2 (Full-menu mode).

### 3.3.3 Monitoring the running status--"Drive Monitoring"

Menu #3 "Drive monitoring" is used to check the running status during maintenance and test running. The display items for "Drive monitoring" are listed in Table 3.5. Using keys, you may check those items in succession. Figure 3.7 shows the status transition diagram for "Drive monitoring."

Table 3.5 Drive Monitoring Display Items

LED monitor shows:	Contents	Unit	Description
3.00	Output frequency	Hz	Output frequency before slip compensation
3.01	Output frequency	Hz	Output frequency after slip compensation
3.02	Output current	A	Present output current
3.03	Output voltage	V	Present output voltage
3.05	Reference frequency	Hz	Present reference frequency
3.06	Rotational direction	N/A	Displays the rotational direction specified by a run command being outputted. F: forward; r: reverse, ----: stop
3.07	Running status	N/A	Displays the running status in hex. format. Refer to "Displaying running status" on the page 3-16.
3.09	Load shaft speed (line speed)	r/min (m/min)	The unit for load shaft speed is r/min and that for line speed is m/min. Display value = (Output frequency Hz before slip compensation) × (Function code E50) □ □ is displayed for 10000 (r/min or m/min) or more. When □ □ is displayed, the data is overflowing, which means that the function code should be reviewed. For example: Load shaft speed = Displayed data × 10 (r/min)
3.10	PID process commands	N/A	These commands are displayed through the use of function code E40 and E41 (PID display coefficient A and B). Display value = (PID process command) × (PID display coefficient A - B) + B If PID control is disabled, "----" appears.
3.11	PID feedback value	N/A	This value is displayed through the use of function code E40 and function code E41 (PID display coefficient A and B). Display value = (PID feedback value) × (PID display coefficient A - B) + B If PID control is disabled, "----" appears.

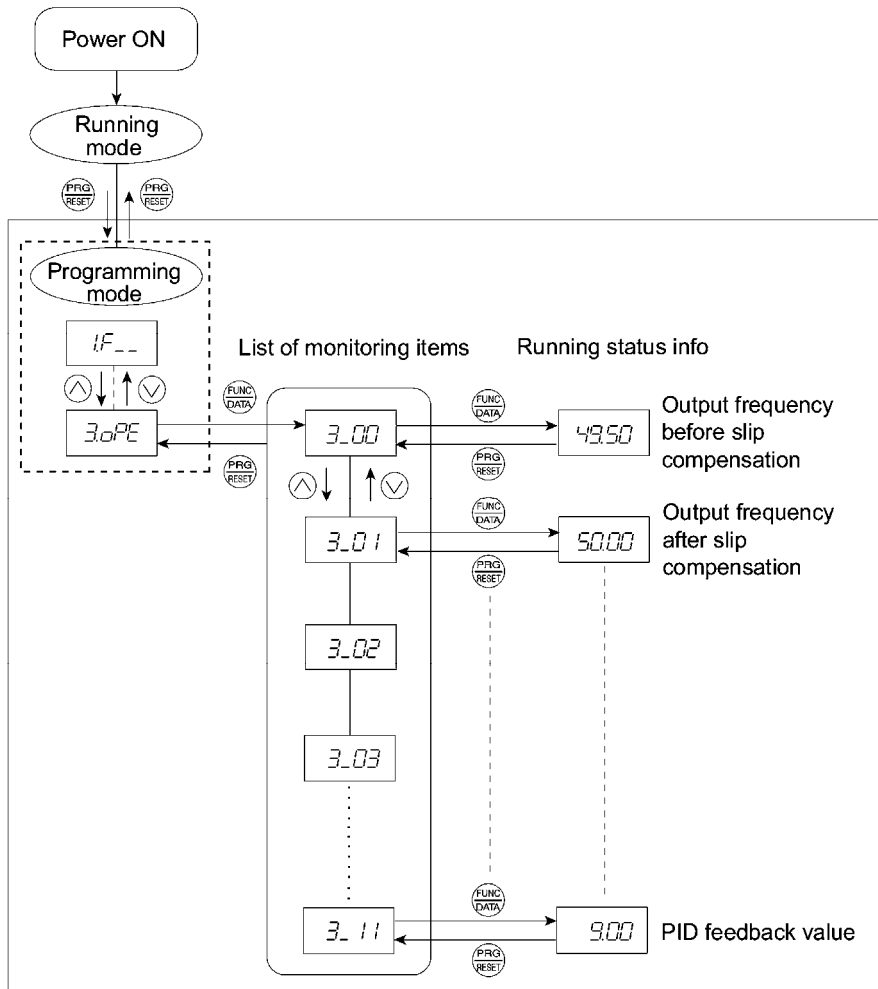

Figure 3.7 Drive Monitoring Status Transition

**Basic key operation**

- (1) With the menu displayed, use  $\wedge$  /  $\vee$  keys to select "Drive monitoring" ( $3.0PE$ ).
- (2) Press the  $\text{FUNC/DATA}$  key to display the desired code in the monitoring items list (e.g.  $3.00$ ).
- (3) Use  $\wedge$  /  $\vee$  keys to select the desired monitoring item, then press the  $\text{FUNC/DATA}$  key.  
The running status information for the selected item will appear.
- (4) Press the  $\text{PRG/RESET}$  key to return to the monitoring items list. Press the  $\text{PRG/RESET}$  key again to return to the menu.

**Tip** If the menu cannot switch to any other one, set function code E52 to 2 (Full-menu mode).

### Displaying running status

To display the running status in hexadecimal format, each state has been assigned to bit 0 to 15 as listed in Table 3.6. Table 3.7 shows the relationship between each of the status assignments and the LED monitor display. Table 3.8 gives the conversion table from 4-bit binary to hexadecimal.

Table 3.6 Running Status Bit Allocation

Bit	Notation	Content
15	BUSY	1 when function code data is being written.
14	WR	Always 0.
13		Always 0.
12	RL	1 when communications is effective (when run commands and set frequencies commands are issued via communications).
11	ALM	1 when an alarm has occurred.
10	DEC	1 during deceleration.
9	ACC	1 during acceleration.
8	IL	1 during current limitation.
7	VL	1 under voltage control.
6	TL	Always 0.
5	NUV	1 when DC link bus voltage has increased up to the specified level (0 for undervoltage).
4	BRK	Always 0.
3	INT	1 when the inverter output is shut down.
2	EXT	1 during DC braking.
1	REV	1 during running in the reverse direction.
0	FWD	1 during running in the forward direction.

Table 3.7 Running Status Display

LED No.	LED4				LED3				LED2				LED1				
	15	14	13	12	11	10	9	8	7	6	5	4	3	2	1	0	
Notation	BUSY	WR		RL	ALM	DEC	ACC	IL	VL	TL	NUV	BRK	INT	EXT	REV	FWD	
Example	Binary	1	0	0	0	0	0	1	1	0	0	1	0	0	0	0	1
	Hexa-decimal (See Table 3.8.)	8				3				2				1			
	Hexa-decimal on the LED monitor	<div style="display: flex; justify-content: center; gap: 10px;"> <span>LED4</span> <span>LED3</span> <span>LED2</span> <span>LED1</span> </div>															



**Hexadecimal expression**

A 16-bit binary number is expressed in hexadecimal format (4 bits). Table 3.8 shows the expression corresponding to decimals. The hexadecimals are shown as they appear on the LED monitor.

Table 3.8 Binary and Hexadecimal Conversion

Binary				Hexadecimal	Decimal	Binary				Hexadecimal	Decimal
0	0	0	0	0	0	1	0	0	0	8	8
0	0	0	1	1	1	1	0	0	1	9	9
0	0	1	0	2	1	0	1	0	A	10	
0	0	1	1	3	1	0	1	1	B	11	
0	1	0	0	4	1	1	0	0	C	12	
0	1	0	1	5	1	1	0	1	D	13	
0	1	1	0	6	1	1	1	0	E	14	
0	1	1	1	7	1	1	1	1	F	15	

**3.3.4 Checking I/O signal status--"I/O Checking"**

With Menu #4 "I/O checking," you may display the status of external I/O signals without using a measuring instrument. External signals that can be displayed include digital I/O signals and analog I/O signals. Table 3.9 lists check items available. The status transition for I/O checking is shown in Figure 3.8.

Table 3.9 I/O Check Items

LED monitor shows:	Display contents	Description
4_00	I/O signals on the control circuit terminals	Shows the ON/OFF state of the digital I/O terminals. Refer to "[1] Displaying control I/O signal terminals" on page 3-19 for details on the display contents.
4_01	I/O signals on the control circuit terminals under communication control	Shows the ON/OFF state for the digital input terminals that received a command via RS-485 communications. Refer to "[1] Displaying control I/O signal terminals" on page 3-19 and "[2] Displaying control I/O signal terminals under communication control" on page 3-20 for details on the display contents.
4_02	Input voltage on terminal [12]	Shows the input voltage on terminal [12] in volts (V).
4_03	Input current on terminal [C1]	Shows the input current on terminal [C1] in milliamperes (mA).
4_04	Output voltage to analog meters [FMA]	Shows the output voltage on terminal [FMA] in volts (V).

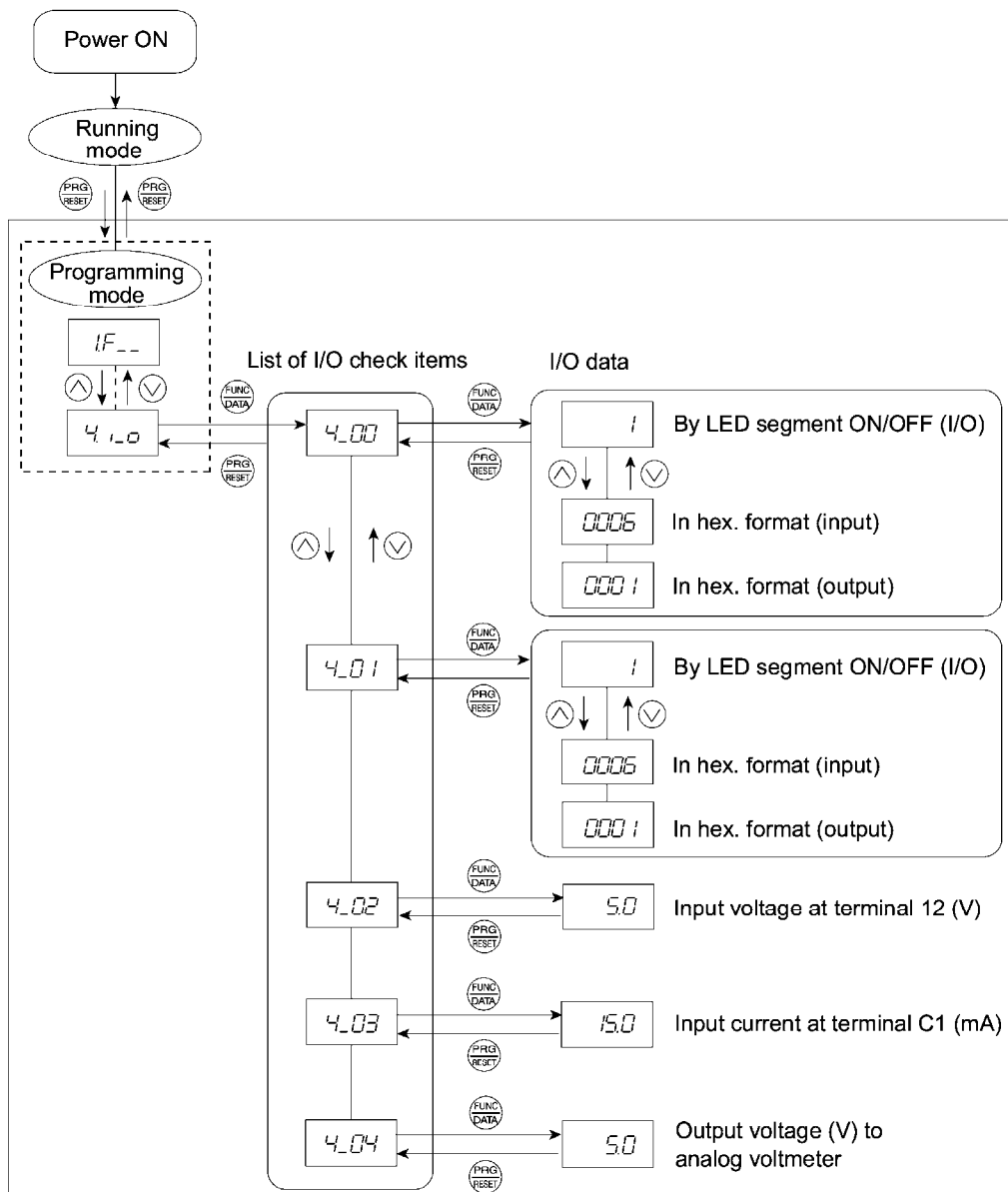

Figure 3.8 Status Transition of I/O Check

### **Basic key operation**

- (1) With the menu displayed, use  $\uparrow/\downarrow$  keys to select "I/O check" ( $4\_I\_0$ )
- (2) Press the  $\text{FUNC DATA}$  key to display the codes for the I/O check item list. (e.g.  $4\_00$ )
- (3) Use  $\uparrow/\downarrow$  keys to select the desired I/O check item, then press the  $\text{FUNC DATA}$  key.  
The corresponding I/O check data will appear. For control circuit I/O terminals, use  $\uparrow/\downarrow$  keys to select one of the two different display methods.
- (4) Press the  $\text{PRG RESET}$  key to return to the I/O check item list. Press the  $\text{PRG RESET}$  key again to return to the menu.

**Tip** If the menu cannot switch to any other one, set function code E52 to 2 (Full-menu mode).

## [ 1 ] Displaying control I/O signal terminals

The I/O signal status of control circuit terminals may be displayed with ON/OFF of the LED segment or in hexadecimal display.

### ■ Display I/O signal status with ON/OFF of the LED segment

As shown in Table 3.10 and the figure below, segments "a" to "e" on LED1 light when the digital input terminals ([FWD], [REV], [X1], [X2], and [X3]) are short-circuited (ON) with the terminal [CM] and do not light when they are opened (OFF). Segment "a" on LED3 lights when the circuit between output terminal [Y1] and terminal [Y1E] is closed (ON) and does not light when the circuit is open (OFF). LED4 is for terminals [30A], [30B], [30C]. Segment "a" on LED4 lights when the circuit between terminals [30C] and [30A] are short-circuited (ON) and does not light when they are opened.

**Note** This LED monitor displays hardware terminal information, which means that it may not light when it is in reverse logic (refer to Chapter 9 "FUNCTION CODES" for details), even when it is active.

Table 3.10 Segment Display for External Signal Information

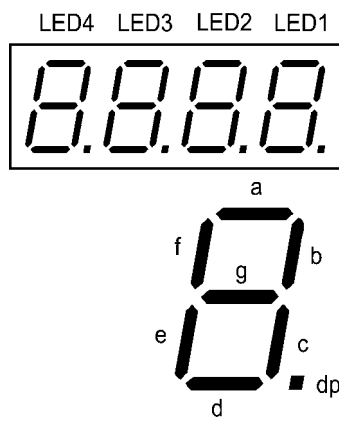

Segment	LED4	LED3	LED2	LED1
a	[30A/B/C]	[Y1]-[Y1E]	-	[FWD]-[CM] or [FWD]-[PLC] <sup>*2</sup>
b	-	-	-	[REV]-[CM] or [REV]-[PLC] <sup>*2</sup>
c	-	-	-	[X1]-[CM] or [X1]-[PLC] <sup>*2</sup>
d	-	-	-	[X2]-[CM] or [X2]-[PLC] <sup>*2</sup>
e	-	-	-	[X3]-[CM] or [X3]-[PLC] <sup>*2</sup>
f	-	-	(XF) <sup>*1</sup>	-
g	-	-	(XR) <sup>*1</sup>	-
dp	-	-	(RST) <sup>*1</sup>	-

- : No correlating control circuit terminals

<sup>\*1</sup> (XF), (XR), and (RST) are reserved for communications. Refer to "[ 2 ] Displaying control I/O signal terminals under communication control."

<sup>\*2</sup> Terminal [CM] if the jumper switch is set for a sink; terminal [PLC] if the jumper switch is set for a source.

## ■ Displaying I/O signal status in hexadecimal format

Each I/O terminal is assigned to bit 15 through bit 0 as listed in Table 3.11. An unassigned bit is interpreted as "0." Allocated bit data is displayed on the LED monitor in 4-digit hexadecimal ("0" to "F" each).

With the FRENIC-Mini, digital input terminals [FWD] and [REV] are assigned to bit 0 and bit 1, respectively. Terminals [X1] through [X3] are assigned to bits 2 through 4. The value "1" is set for each bit when the assigned input terminal is short-circuited (ON) with terminal [CM]. The value "0" when it opens (OFF). For example, when [FWD] and [X1] are ON and all others are OFF, the display on LED4 to LED1 would be 0005.

Bit 0 is assigned to digital output terminal [Y1]. The value "1" is set when the terminal is short-circuited with [Y1E], and the value "0" is set when it opens. The status of the mechanical relay contact output terminal [30A], [30B] and [30C] are assigned to bit 8. The value "1" is set when the circuit between output terminals [30A] and [30C] is closed and the value "0" when the circuit between [30B] and [30C] is closed. For example, if [Y1] is ON and the circuit between [30A] and [30C] are short-circuited with each other, then the display for LED4 to LED1 would be 0101.

How the hexadecimal display is configured for the terminals to which bits 0 to 15 are assigned and the 7-segment LED is shown below.

Table 3.11 Segment Display for I/O Signal Status in Hexadecimal Format

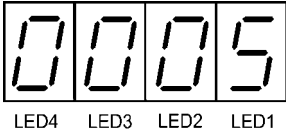
LED No.	LED4				LED3				LED2				LED1				
Bit	15	14	13	12	11	10	9	8	7	6	5	4	3	2	1	0	
Input terminal	(RST)*	(XR)*	(XF)*	-	-	-	-	-	-	-	-	[X3]	[X2]	[X1]	[REV]	[FWD]	
Output terminal	-	-	-	-	-	-	-	[30A/C]	-	-	-	-	-	-	-	[Y1]	
Example	Binary	0	0	0	0	0	0	0	0	0	0	0	0	0	1	0	1
	Hexa-decimal (See Table 3.8.)	0				0				0				5			
	Hexa-decimal on the LED monitor																

- : No correlating control terminals

\* (XF), (XR), and (RST) are reserved for communications. Refer to "[ 2 ] Displaying control I/O signal terminals under communication control" below.

## [ 2 ] Displaying control I/O signal terminals under communication control

There are two control circuit input displays under communications link control – "display with ON/OFF of the LED segment" and "in hexadecimal format" for input commanded from RS-485 communications link. The content is similar to that of the control circuit I/O signal terminal status display; however, (XF) and (XR) are added as inputs and nothing is assigned as output terminals.

 Refer to the RS-485 Communication User's Manual (MEH448) for details on command inputs through RS-485 communication.

### 3.3.5 Reading maintenance information--"Maintenance Information"

Menu #5 "Maintenance information" in Programming mode contains information necessary for performing maintenance on the inverter. Table 3.12 lists the maintenance information display items and Figure 3.9 shows the status transition for maintenance information.

Table 3.12 Maintenance Display Items

LED monitor shows:	Display contents	Description
5_00	Accumulated run time	Shows the accumulated power-ON time of the inverter. Unit: 1,000 hours When the count is less than 10,000 hours (display: 0.001 to 9.999), it is possible to check data in units of hours. When the count is 10,000 hours or more (display: 10.00 to 65.53), the display will change to units of 10 hours. When it exceeds 65,535 hours, the count will be reset to "0" and start over again.
5_01	DC link bus voltage	Shows the DC link bus voltage of the inverter. Unit: V (volts)
5_03	Max. temperature of heat sink	Shows the maximum temperature of the heat sink for every hour. Unit: °C
5_04	Max. effective current	Shows the maximum effective current for every hour. Unit: A (amperes)
5_05	Capacitance of the DC link bus capacitor	Shows the current capacitance of the DC link bus capacitor, based on the capacitance when shipped as 100%. Refer to the FRENIC-Mini Instruction Manual, Chapter 7 "MAINTENANCE AND INSPECTION" for details. Unit: %
5_06	Accumulated run time of electrolytic capacitors on the printed circuit boards	Shows the accumulated time during which a voltage is applied to the electrolytic capacitors on the printed circuit boards. Unit: 1,000 hours (Display range: 0.01 to 99.99) When the count is less than 99,990 hours (Display: 0.01 to 99.99), it is possible to check data in units of 10 hours (0.01). When the count exceeds 99,990 hours, it stops and the LED monitor sticks to 99.99.
5_07	Accumulated run time of the cooling fan	Shows the accumulated run time of the cooling fan. If the cooling fan ON/OFF control (function code H06) is enabled, the time when the fan is stopped is not counted. Unit: 1,000 hours (Display range: 0.01 to 99.99) When the count is less than 99,990 hours (Display: 0.01 to 99.99), it is possible to check data in units of 10 hours (0.01). When the count exceeds 99,990 hours, it stops and the LED monitor sticks to 99.99.
5_08	Number of startups	The motor run times (the number of times the inverter run command is set to ON) are calculated and displayed. 1.000 indicates 1,000 times. When any number ranging from 0.001 to 9.999 is displayed, the count increases by 0.001 per startup, and when any number from 10.00 to 65.53 is displayed, the count increases by 0.01 every 10 startups. If the count exceeds 65,535, it will be reset to "0" and start over again.
5_09	Input watt-hour	Shows the input watt-hour of the inverter. Unit: 100 kWh (Display range: 0.001 to 9999) Depending on the value of input watt-hour, the decimal point on the LED monitor shifts to show it within the LED monitors' resolution (Display resolution: 0.001 → 0.01 → 0.1 → 1). To reset the integrated input watt-hour and its data, set function code E51 to "0.000." When the count exceeds 1,000,000 kWh, it will be reset to "0."

Table 3.12 Maintenance Display Items (Continued)

LED monitor shows:	Display contents	Description
<i>S_10</i>	Input watt-hour data	Shows the value expressed by "input watt-hour (kWh) × E51 (whose data range is 0.000 to 9,999)." Unit: None. (Display range: 0.001 to 9999. The data cannot exceed 9999. (It will be fixed at 9,999 once the calculated value exceeds 9999.)) Depending on the value of integrated input watt-hour data, the decimal point on the LED monitor shifts to show it within the LED monitors' resolution. To reset the integrated input watt-hour data, set function code E51 to "0.000."
<i>S_11</i>	No. of RS-485 errors	Shows the total number of errors that have occurred in RS-485 communication after the power is turned ON. Once the count exceeds 9,999, it will be reset to "0."
<i>S_12</i>	RS-485 error contents	Shows the latest error that has occurred in RS-485 communication in decimal format. For error contents, refer to the RS-485 Communication User's Manual (MEH448).
<i>S_14</i>	Inverter's ROM version	Shows the inverter's ROM version as a 4-digit code.
<i>S_15</i>	Keypad's ROM version	Shows the keypad's ROM version as a 4-digit code. (Available only when an optional remote keypad is connected.)
<i>S_23</i>	Accumulated run time of motor	Shows the content of the accumulated run time of motor. The display method is the same as for "Accumulated run time" ( <i>S_00</i> ).
<i>S_31</i>	Remaining time before the next motor 1 maintenance	Shows the time remaining before the next maintenance, which is estimated by subtracting the cumulative run time of motor 1 from the maintenance interval specified by H78. (This function applies to motor 1 only.) Display range: 0 to 9999 The x10 LED turns ON. Time remaining before the next maintenance (hour) = Displayed value × 10
<i>S_35</i>	Remaining startup times before the next maintenance	Shows the startup times remaining before the next maintenance, which is estimated by subtracting the number of startups from the preset startup count for maintenance specified by H79. (This function applies to motor 1 only.) The display method is the same as for <i>S_08</i> above.

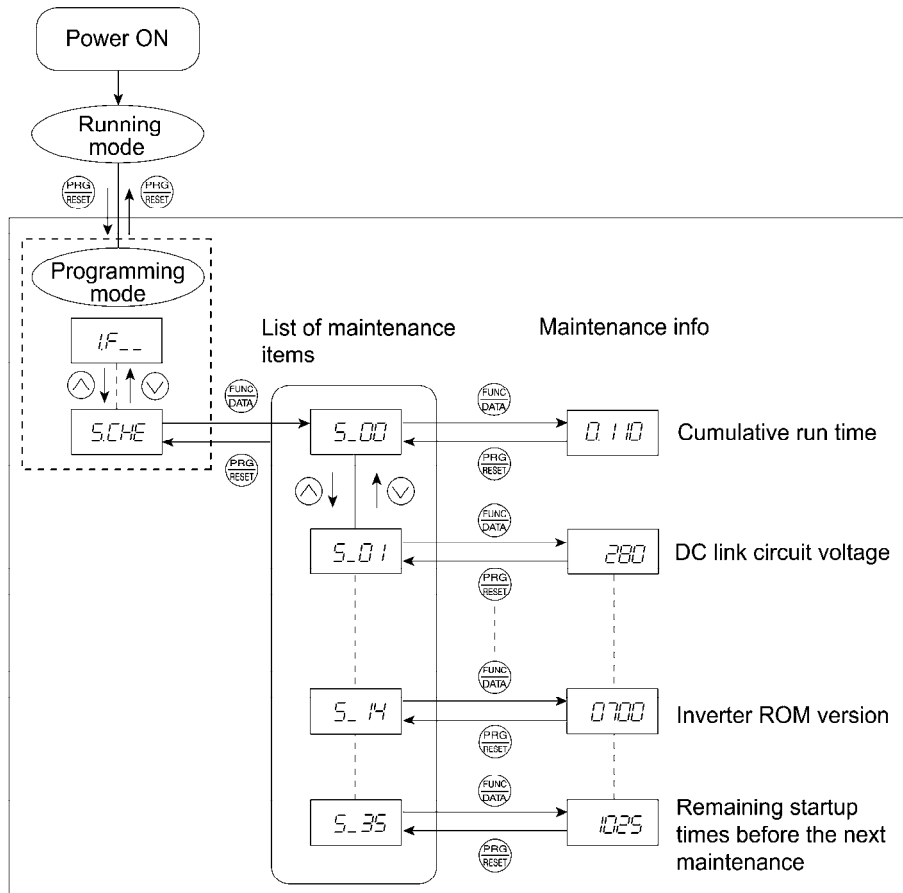

Figure 3.9 Status Transition of Maintenance Information

**Basic key operations**

- (1) With the menu displayed, use  $\uparrow$ / $\downarrow$  keys to select "Maintenance information" (*S.CHE*).
- (2) Press the  $\text{FUNC/DATA}$  key to display the list of maintenance item codes (e.g. *S\_00*).
- (3) Use  $\uparrow$ / $\downarrow$  keys to select the desired maintenance item, then press the  $\text{FUNC/DATA}$  key.  
The data of the corresponding maintenance item will appear.
- (4) Press the  $\text{PRG/RESET}$  key to return to the list of maintenance items. Press the  $\text{PRG/RESET}$  key again to return to the menu.

**Tip** If the menu cannot switch to any other one, set function code E52 to 2 (Full-menu mode).

### 3.3.6 Reading alarm information--"Alarm Information"

Menu #6 "Alarm information" in Programming mode shows the cause of the past 4 alarms as alarm codes. Further, it is also possible to display alarm information that indicates the status of the inverter when the alarm occurred. Table 3.13 shows the contents of the alarm information and Figure 3.10 shows the status transition of the alarm information.

Table 3.13 Alarm Information Contents

LED monitor shows: (Item No.)	Display contents	Description
<i>6_00</i>	Output frequency	Output frequency before slip compensation
<i>6_01</i>	Output current	Present output current
<i>6_02</i>	Output voltage	Present output voltage
<i>6_03</i>	Calculated torque	Calculated motor output torque
<i>6_04</i>	Reference frequency	Present reference frequency
<i>6_05</i>	Rotational direction	This shows the rotational direction of a run command being output. F: forward; r: reverse; ---: stop
<i>6_06</i>	Running status	This shows the running status as a hexadecimal display. Refer to <u>Displaying running status</u> in Section 3.3.3 "Monitoring the running status."
<i>6_07</i>	Accumulated running time	Shows the cumulative power-ON time of the inverter. Unit: thousands of hours. When the total ON time is less than 10,000 hours (display: 0.001 to 9.999), it is possible to check data in hourly units. When the total time is 10,000 hours or more (display: 10.00 to 65.53), the display will change to units of 10 hours. When the total time exceeds 65,535 hours, the display returns to 0 and the count will start again.
<i>6_08</i>	No. of startups	The motor run times (the number of times the inverter run command is set to ON) are calculated and displayed. 1.000 indicates 1,000 times. When any number from 0.001 to 9.999 is displayed, the display increases by 0.001 per startup, and when any number from 10.00 to 65.53 is displayed, the display increases by 0.01 every 10 startups.
<i>6_09</i>	DC link bus voltage	Shows the DC link bus voltage of the inverter's main circuit. Unit: V (volts)
<i>6_11</i>	Max. temperature of heat sink	Shows the maximum temperature of the heat sink. Unit: °C
<i>6_12</i>	Terminal I/O signal status (displayed with the ON/OFF of LED segments)	Shows the ON/OFF status of the digital I/O terminals. Refer to Section 3.3.4 "[1] Displaying control I/O signal terminals" for details.
<i>6_13</i>	Terminal input signal status (in hexadecimal format)	
<i>6_14</i>	Terminal output signal status (in hexadecimal display)	
<i>6_15</i>	No. of consecutive occurrences	This is the number of times the same alarm has occurred consecutively.
<i>6_16</i>	Overlapping alarm 1	Simultaneously occurring alarm codes (1) (--- is displayed if no alarms have occurred.)



Table 3.13 Alarm Information Contents (Continued)

LED monitor shows: (Item No.)	Display contents	Description
<i>E_17</i>	Overlapping alarm 2	Simultaneously occurring alarm codes (2) (--- is displayed if no alarms have occurred.)
<i>E_18</i>	Terminal I/O signal status under communication control (displayed with the ON/OFF of LED segments)	Shows the ON/OFF status of the digital I/O terminals under RS-485 communication control. Refer to Section 3.3.4 "[2] Displaying control I/O signal terminals under communication control" for details.
<i>E_19</i>	Terminal input signal status under communication control (in hexadecimal format)	
<i>E_20</i>	Terminal output signal status under communication control (in hexadecimal display)	
<i>E_21</i>	Error sub code	Secondary error code for the alarm.
<i>E_22</i>	Running status 2	Shows the running status 2 in hexadecimal format. For details, see the table below.
<i>E_24</i>	Running status 3	Shows the running status 3 in hexadecimal format. For details, see the table below.

 **Note** When the same alarm occurs a number of times in succession, the alarm information for the first time is retained and the information for the following alarms is not updated.

Table 3.14 Running Status 2 (*E\_22*) Bit Assignment

Bit	Content	Bit	Content
15	Drive motor type 0: Induction motor, 1: Permanent magnet synchronous motor	7	(Not used.)
14	(Not used.)	6	
13		5	Motor selection
12		4	00: Motor 1 01: Motor 2
11		3	Inverter drive control
10		2	0000: V/f control with slip compensation inactive
9		1	0001: Dynamic torque vector control
8	Rotation direction limitation 0: Enable, 1: Disable	0	0010: V/f control with slip compensation active

Table 3.15 Running Status 3 (E<sub>24</sub>) Bit Assignment

Bit	Notation	Content	Bit	Notation	Content
15	-	(Not used.)	7	-	(Not used.)
14	ID2	Current detected 2	6	-	(Not used.)
13	IDL	Low current detected	5	OL	Motor overload early warning
12	ID	Current detected	4	IPF	Auto-restarting after momentary power failure
11	OLP	Overload prevention control	3	SWM2	Motor 2 selected
10	LIFE	Lifetime alarm	2	-	(Not used.)
9	OH	Heat sink overheat early warning	1	FDT	Frequency detected
8	TRY	Auto-resetting	0	FAR	Frequency arrival signal

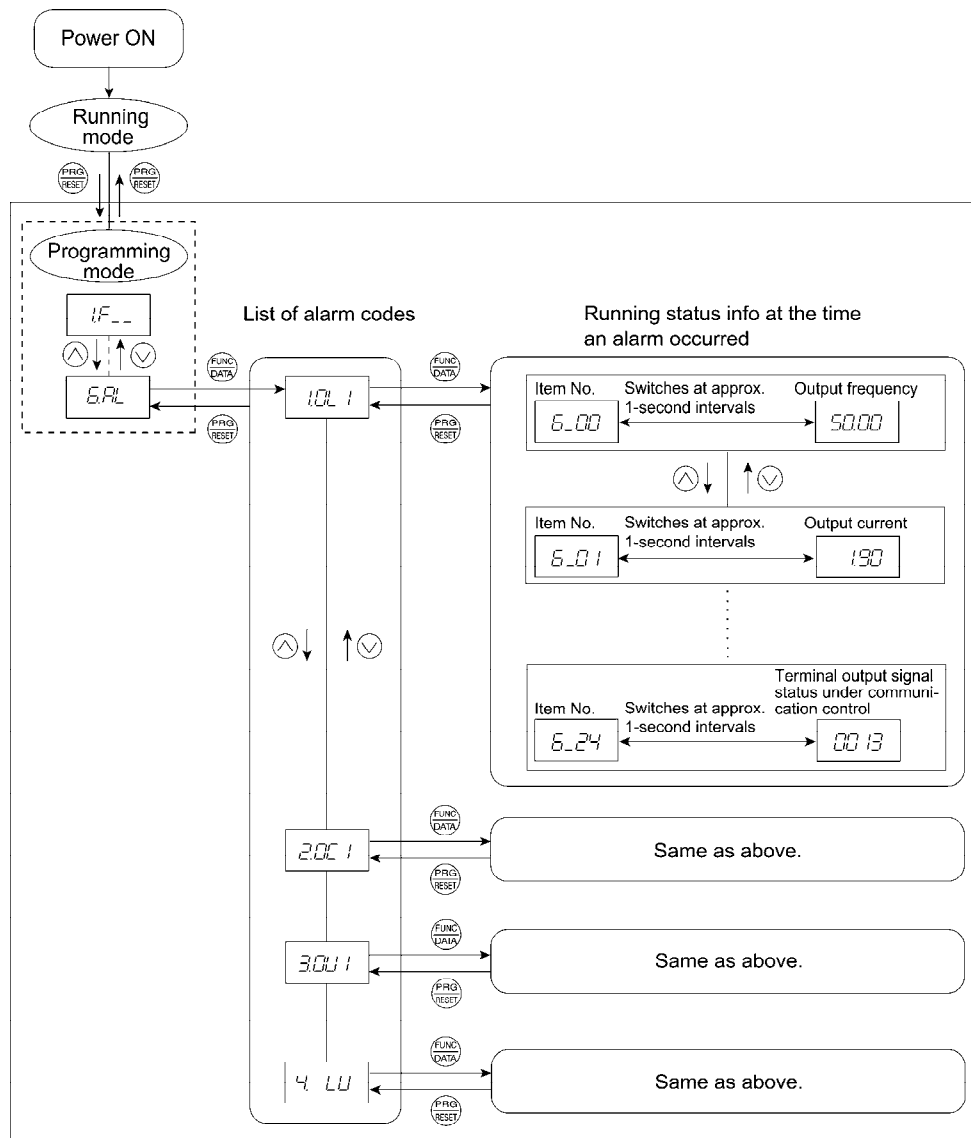

Figure 3.10 Status Transition of Alarm Information

### Basic key operations

- (1) With the menu displayed, use  $\wedge$  /  $\vee$  keys to select "Alarm information" (E.AL).
- (2) Press the  $\text{FUNC/DATA}$  key to display the alarm list code (e.g. 1.OL 1).  
In the list of alarm codes, the alarm information for the last 4 alarms will be saved as an alarm history.
- (3) Each time  $\wedge$  /  $\vee$  keys are pressed, the last four alarms are displayed in order from the most recent one as "1", "2", "3" and "4".
- (4) Press the  $\text{FUNC/DATA}$  key while the alarm code is displayed, and the corresponding alarm item number (e.g. E\_00) and data (e.g. Output frequency) will be displayed continuously in turn for 1 second each. It is possible to display the item number (e.g. E\_01) and data (e.g. Output current) for each desired alarm using  $\wedge$  /  $\vee$  keys.
- (5) Press the  $\text{PRG/RESET}$  key to return to the alarm list. Press the  $\text{PRG/RESET}$  key again to return to the menu.

**Tip** If the menu cannot switch to any other one, set function code E52 to 2 (Full-menu mode).

## 3.4 Alarm Mode

When the protective function is activated to issue an alarm, the inverter automatically transfers to Alarm mode and the alarm code will appear in the LED monitor. Figure 3.11 shows the status transition of Alarm mode.

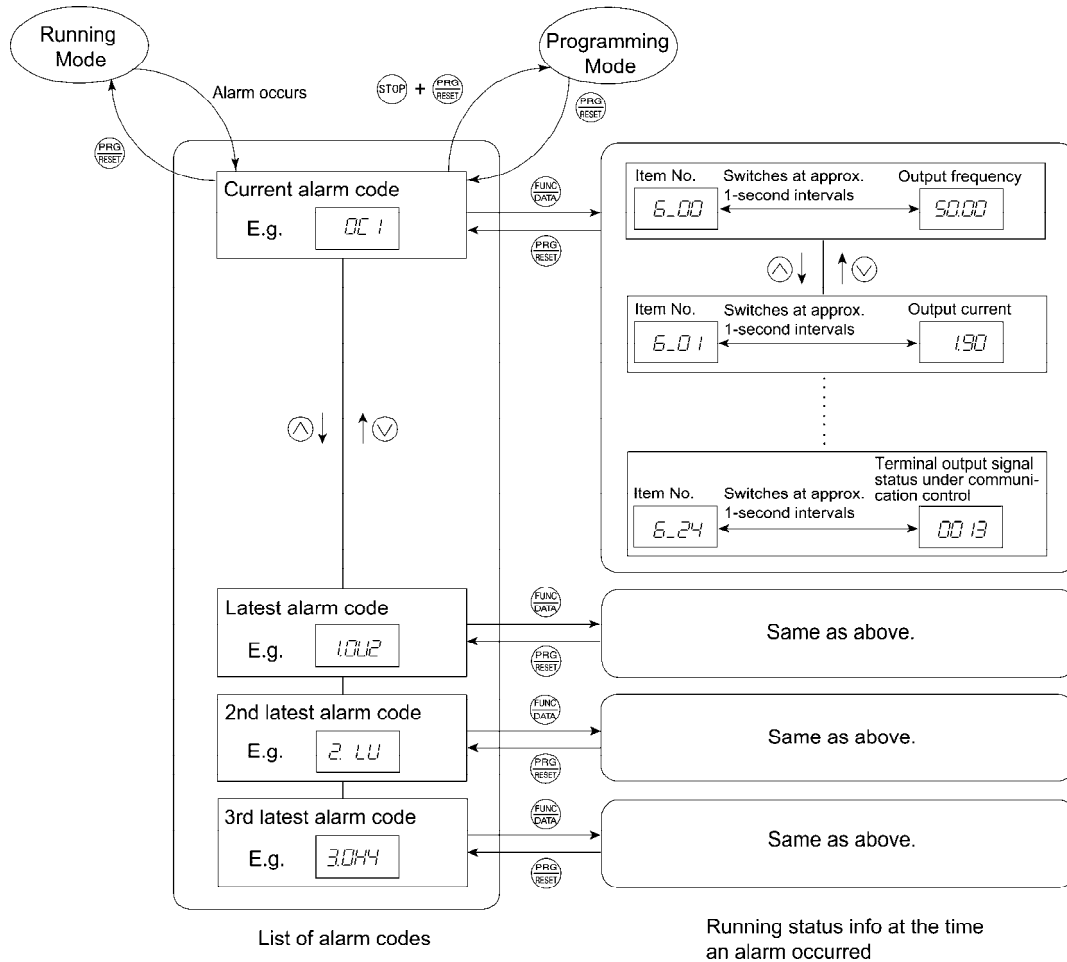

Figure 3.11 Status Transition of Alarm Mode

### 3.4.1 Releasing the alarm and transferring the inverter to Running mode



Remove the cause of the alarm and press the **PRG/RESET** key to release the alarm and return to Running mode. The **PRG/RESET** key is enabled only when the alarm code is displayed.

### 3.4.2 Displaying the alarm history



It is possible to display the most recent 3 alarm codes in addition to the one currently displayed. Previous alarm codes can be displayed by pressing **▲/▼** keys while the current alarm code is displayed.

### 3.4.3 Displaying the running information when an alarm occurs



If an alarm occurs, you may check various running status information (output frequency and output current, etc.) by pressing the  key when the alarm code is displayed. The item number and data for each running information is displayed in alternation.

Further, you can switch between the various running information using  /  keys. Detailed running information is the same as for Menu #6 "Alarm information" in Programming mode. Refer to Table 3.13 in Section 3.3.6 "Reading alarm information."

Pressing the  key while the running information is displayed returns the display to the alarm codes.

 Pressing the  key continuously a number of times while the running information is displayed after removing the cause of the alarm will cause the inverter to transit to the alarm code display, and the next alarm to be released. If a run command had been input at this stage, the motor will start up.

### 3.4.4 Transferring to Programming mode

Further, it is also possible to transfer the inverter to Programming mode by pressing  +  keys simultaneously while the alarm is displayed and to then check and adjust the function code data.



---

# Chapter 4

## BLOCK DIAGRAMS FOR CONTROL LOGIC

This chapter describes the main block diagrams for the control logic of the FRENIC-Mini series of inverters.

### Contents

4.1	Symbols Used in the Block Diagrams and their Meanings.....	4-1
4.2	Drive Frequency Command Generator .....	4-2
4.3	Drive Command Generator .....	4-4
4.4	Terminal Command Decoders.....	4-6
4.5	Digital Output Selector .....	4-10
4.6	Analog Output (FMA) Selector .....	4-12
4.7	Drive Command Controller.....	4-13
4.8	PID Frequency Command Generator.....	4-16





FRENIC-Mini inverters are equipped with a number of function codes to match a variety of motor operations required in your system. Refer to Chapter 9 "FUNCTION CODES" for details of the function codes.

The function codes have functional relationship with each other. Several special function codes also work with execution priority with each other depending upon their data settings.







This chapter contains the main block diagrams for control logic in the inverter and describes the relationship between the inverter's logic and function codes. It is important to fully understand this relationship and to set the function code data correctly.

The block diagrams contained in the chapter show only function codes having mutual relation. For the function codes that work stand-alone and for details of individual function codes, refer to Chapter 9 "FUNCTION CODES."

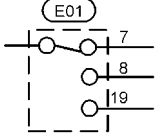
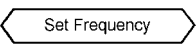
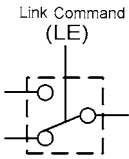
## 4.1 Symbols Used in the Block Diagrams and their Meanings

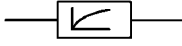
Table 4.1 lists the symbols commonly used in the block diagrams and their meanings with some examples.

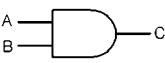
Table 4.1 Symbols and Meanings

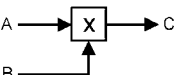
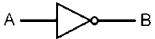
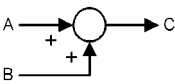
Symbol	Meaning	Symbol	Meaning
[FWD],[Y1] (etc.)	Input/output signals to/from the inverter's control terminal block.		Function code.
(FWD),(REV) (etc.)	Control commands assigned to the control terminal block input signals.		Switch controlled by a function code. Numbers assigned to the terminals express the function code data.
	Internal control command for inverter logic.		Switch controlled by an internal control command. In the example shown at the left, the link operation command (LE) is assigned to one of the digital input terminals from [X1] to [X3], which then controls the switch.
	High limiter: Limits peak value by a constant or by data set to the function code.		Low-pass filter: Features appropriate characteristics by changing the time constant through the function code data.
	Low limiter: Limits the bottom value by a constant or by data set to the function code.		AND logic: In normal logic systems, only if A = ON and B = ON, then C = ON. Otherwise, C = OFF.
	Zero limiter: Keeps data from dropping to a negative value.		OR logic: In normal logic systems, if any inputs are ON, then C = ON. Only if all inputs are OFF, then C = OFF.
	Gain multiplier for set frequencies given by current and/or voltage input or for analog output signals. $C = A \times B$		NOT logic: In normal logic systems, if A = ON, then B = OFF and vice versa.
	Adder for 2 signals or values. $C = A + B$ If B is negative then $C = A - B$ .		

## 4.2 Drive Frequency Command Generator

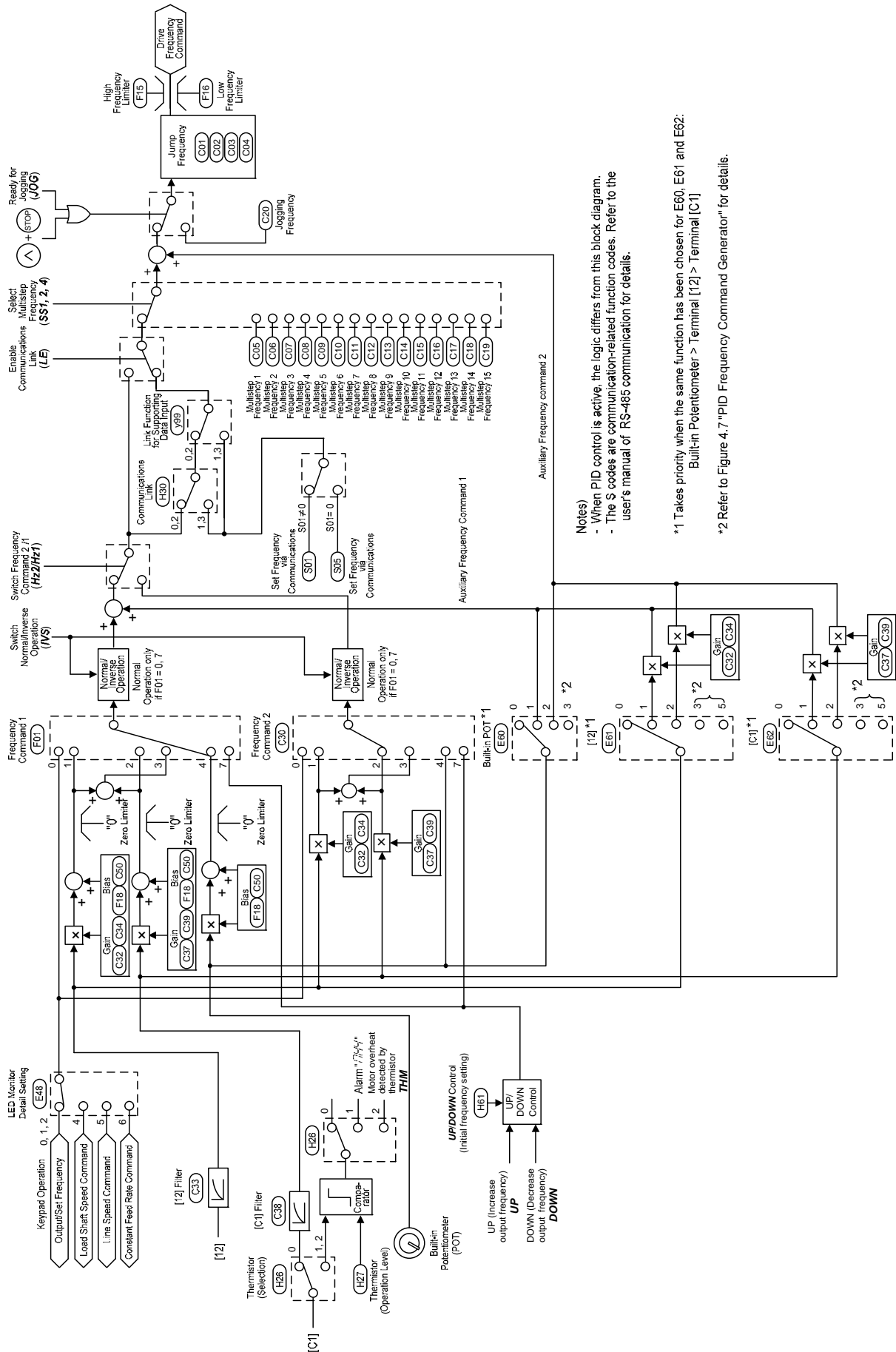

Notes)
 

- When PID control is active, the logic differs from this block diagram.
- The S codes are communication-related function codes. Refer to the user's manual of RS-485 communication for details.

 \*1 Takes priority when the same function has been chosen for E60, E61 and E62:  
 Built-in Potentiometer > Terminal [12] > Terminal [C1]
   
 \*2 Refer to Figure 4.7 "PID Frequency Command Generator" for details.

Figure 4.1 Block Diagram for Drive Frequency Command Generator

Figure 4.1 shows the processes that generate the final drive frequency command from the frequency settings given by various means and those switched/modified by function codes. If PID process control takes effect (J01=1 or 2), the drive frequency generation will differ from that shown in this diagram. (Refer to Section 4.8 "PID Frequency Command Generator.")





Additional and supplemental information is given below.

- Frequency settings using the  $\text{⤴}$  /  $\text{⤵}$  key on the keypad may take a different format by means of the data setting for function code E48. Refer to function code E48 in Chapter 9 "FUNCTION CODES" for details.
- [C1] input as a frequency settings signal will always be interpreted as "0" when the current input signal terminal [C1] is specified for the thermistor (H26 = 1, 2).
- Settings for both gain and bias will take effect concurrently only for frequency setting 1 (F01). For frequency setting 2 (C30) and auxiliary frequency settings 1 and 2 (E60 to E62), only the gain will take effect.
- Gain for the built-in potentiometer cannot be changed by any function code or other means.
- Switching between normal and inverse operation is only effective for frequency setting from the analog input signal (terminal [12], [C1] or built-in potentiometer). Frequency settings from the  $\text{⤴}$  /  $\text{⤵}$  key are only valid for normal operation.
- The command formats for frequency settings by S01 and S05 for the communications link facility take a different form, as follows:
  - S01: the setting range is  $-32768$  to  $+32767$ , where the maximum output frequency is obtained at  $\pm 20000$ .
  - S05: the setting range is  $0.00$  to  $655.35$  Hz in  $0.01$  Hz step, or  $0.1$  Hz step for the maximum frequency exceeding  $600$  Hz.
  - Priority level for setting for S01 is higher than that for S05. If a value other than  $0$  is set for S01, then the data set to S01 will take effect. If  $S01 = 0$ , the setting for S05 will take effect.
  - Refer to the RS-485 Communication User's Manual (MEH448) for details.







The drive command generator shown in Figure 4.2 produces final drive commands (**FWD**: Drive the motor in the forward direction) and (**REV**: Drive the motor in reverse direction) from the run commands that are given by various means and modified/switched by function codes.

Additional and supplemental information is given below.

- For the run command given by the  /  key, the generator holds the command ON upon depression of the  key and releases it upon depression of the  key except during jogging operation.
- The hold command **HLD** holds the run forward/reverse commands **FWD/REV** until it is turned OFF. This allows you to run the inverter in "3-Wire Operation." Refer to the function code E01 in Chapter 9 "FUNCTION CODES" for details.

If you do not assign a hold command **HLD** to any digital input terminals, then the "2-Wire Operation" using the **FWD** and **REV** command will be active.

- Setting 0 (zero) for function code F02 allows you to operate the inverter using the  /  key on the built-in keypad for the run command, while the **FWD** and **REV** commands determine direction of motor rotation. The logic shown in the block diagram shows you that if the run command from the  key and either the **FWD** or **REV** command are given, then the internal run command <FWD> or <REV> decoded internally by the logic turns ON.
- S06 (2-byte data for bit 15 through bit 0 can be manipulated), the operation command by the communications link, includes:
  - Bit 0: assigned to **FWD**
  - Bit 1: assigned to **REV**
  - Bits 13 and 14: programmable bits equivalent to the terminal inputs [FWD] and [REV]
  - In the block diagram, all of these are noted as operation commands. The data setting for function code E98 to specify the terminal signal property for [FWD] and E99 for [REV] determine which bit value should be selected as the run command. If bits 13 and 14 have the same setting to specify the property for (FWD) or (REV), the output of bit 13-14 processor logic will follow the truth table listed in Figure 4.2.
  - If either one of bits 13 and 14 is ON (1 as logic value), the OR logic will make the link command **LE** turn ON.
- If both run commands **FWD** and **REV** come ON concurrently, the logic forces the internal run commands <FWD> and <REV> to immediately turn OFF.
- If you set 1 or 3 to function code H96 (STOP key priority/Start Check) to make the  key priority effective, then depressing the  key forces the internal run commands <FWD> and <REV> to immediately turn OFF.
- If you have enabled operation via the timer, inputting any run command starts the timer. The internal run command <FWD> or <REV> and hold command **HLD** triggered by keypad will be automatically turned OFF after the time preset in the timer has elapsed.
- If the reference frequency is lower than the start frequency (F23) or the stop frequency (F25), the internal run commands will remain OFF.

# 4.4 Terminal Command Decoders

Figures 4.3 (a) through (d) show five types of the terminal command decoder for the digital input signals.

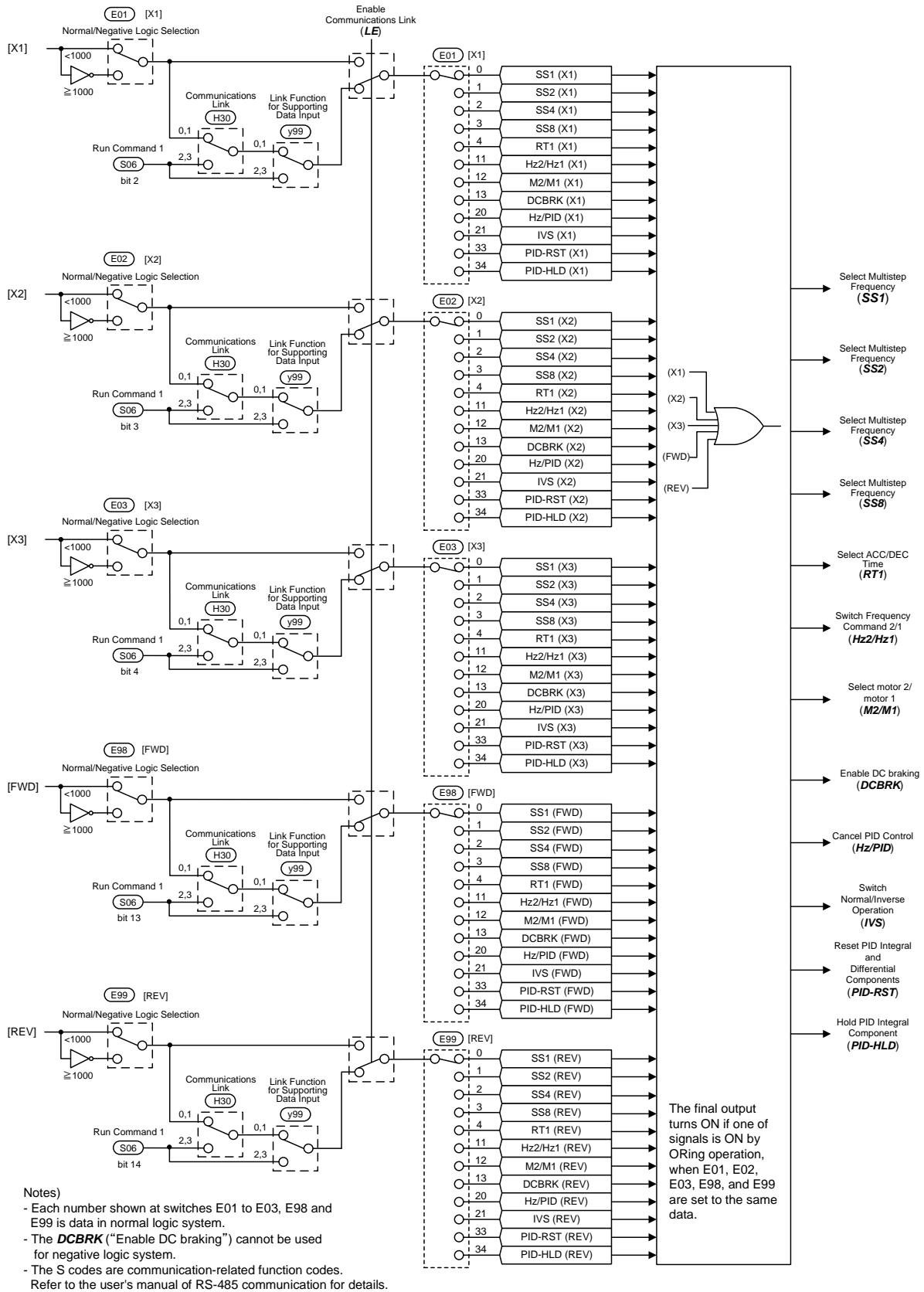

Figure 4.3 (a) Terminal Command Decoder (General)

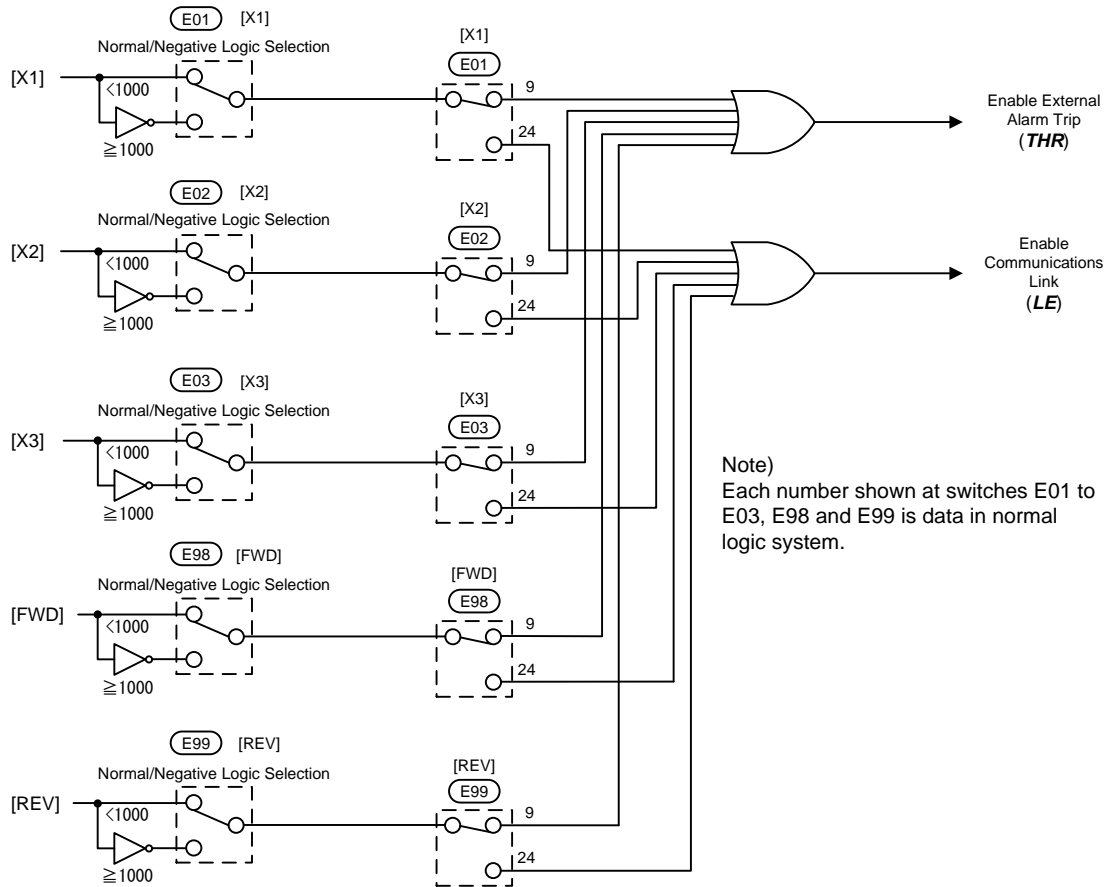

Figure 4.3 (b) Terminal Command Decoder (Terminal Signal Inputs)

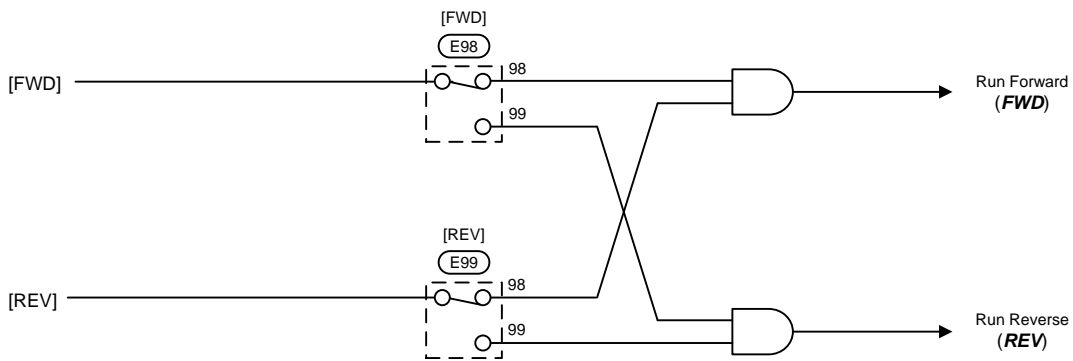
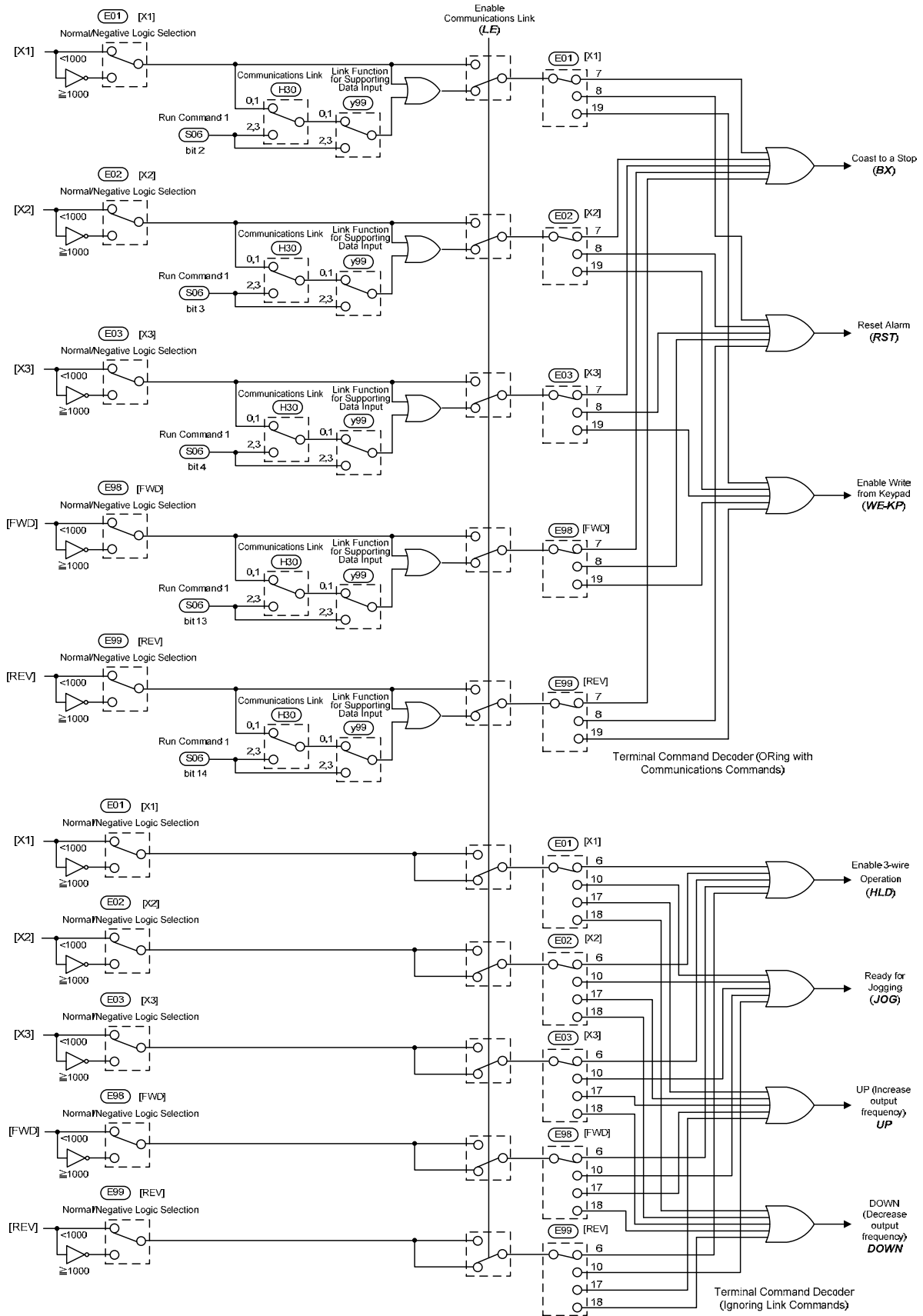

Figure 4.3 (c) Terminal Command Decoder (Terminal Signal Input Excluding Negative Logic)



Notes)  
 - Each number shown at switches E01 to E03, E98 and E99 is data in normal logic system.  
 - The S codes are communication-related function codes.  
 Refer to the user's manual of RS-485 communication for details.

Figure 4.3 (d) Terminal Command Decoder (ORing with Link Commands/Ignoring Link Commands)



Programmable digital input terminals [X1], [X2], [X3], [FWD] and [REV] can be assigned to internal terminal commands such as **FWD** or **REV** decoded by data settings of related function codes as shown in the block diagrams in Figures 4.3 (a) through 4.3 (d). In the decoders, negative logic input signals are also applicable if you set data of 1000s to the function code.

The contents of the block diagram are divided into five groups, depending on whether inputs are assigned for the same internal terminal commands respectively or the commands issued from the communications facility (linked operation) specify the internal commands. Each of the diagrams shown in Figure 4.3 has following role.

- Figure 4.3 (a) The terminal command decoder (general) shows the decoding process of the internal commands functioning with the negative logic inputs. This is switchable with inputs from the communications facility (for example, link operation commands received through RS-485 communications).
- Figure 4.3 (b) The terminal command decoder (terminal signal inputs) shows the process to decode internal terminal commands dedicated to the control signal input applied to the inverter's terminal block. These commands cannot be changed via the communications facility (link operation command).
- Figure 4.3 (c) The terminal command decoder (terminal signal input excluding negative logic) shows process to produce **FWD** and **REV** commands. In this process, settings via the communications facility do not take effect. In the next process of the drive command generator, however, they may take effect. (Refer to the block diagram in Section 4.3, "Drive Command Generator.") To keep the inverter operation safe, any negative logic input for the **FWD** and **REV** commands cannot be applied.
- Figure 4.3 (d) The upper part of the terminal command decoder (ORing with link commands/ignoring link commands) shows the process to produce commands by ORing signals issued from the communications facility and the control signal input terminal block (Logical Oring. If any of input signals is ON, then the command becomes ON.).

The lower part of the terminal command decoder shows the control in which only digital inputs of all control signals are enabled even if link operation command **LE** has been turned ON.

# 4.5 Digital Output Selector

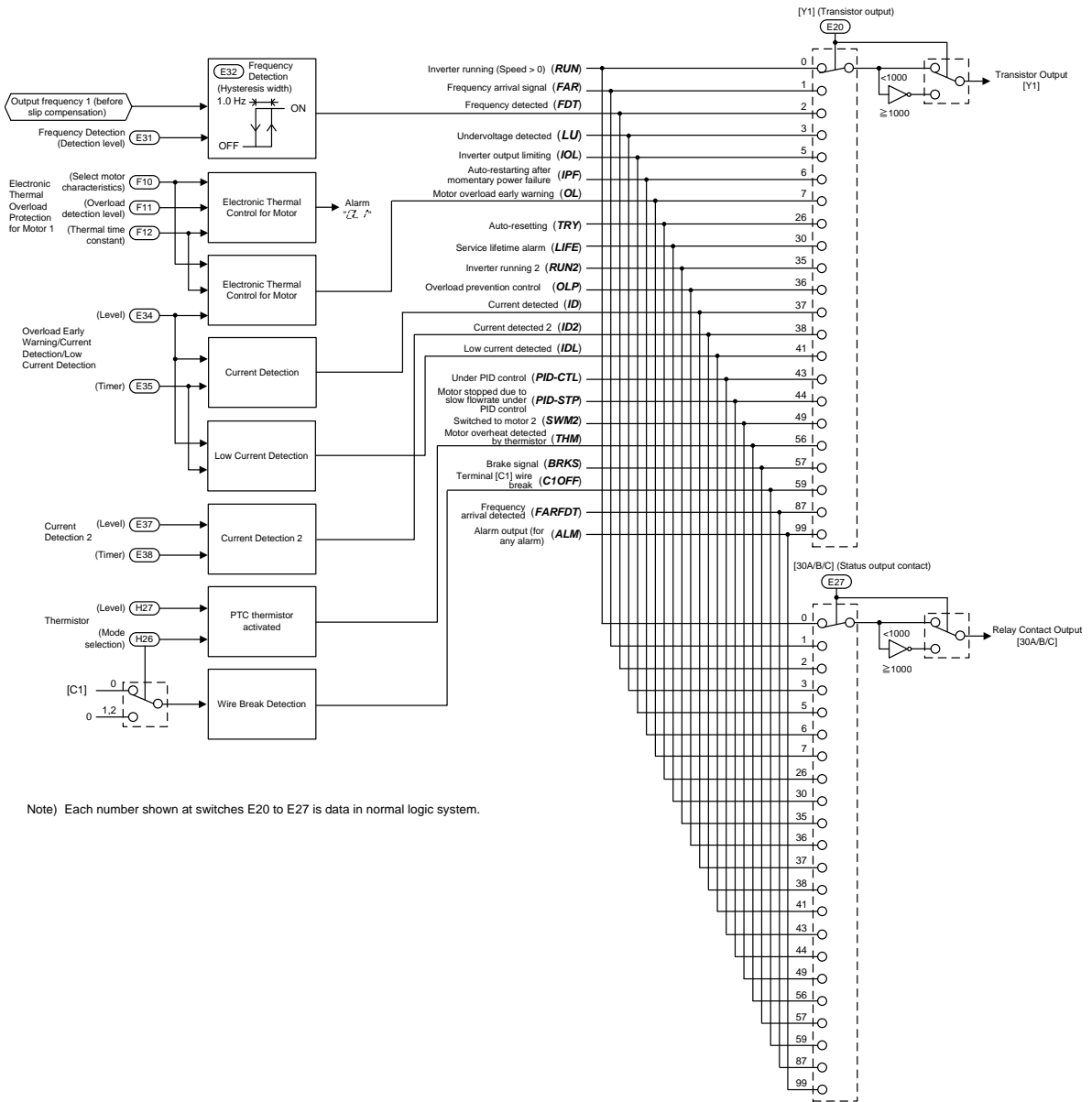

Note) Each number shown at switches E20 to E27 is data in normal logic system.

Figure 4.4 Digital Output Signal Selector

The block diagram shown in Figure 4.4 shows you the processes to select the internal logic signals for feeding to two digital output signals [Y1] and [30A/B/C]. The output terminals [Y1] (a transistor switch) and [30A/B/C] (mechanical relay contacts) are programmable. You can assign various functions to these terminals using function codes E20 and E27. Setting data of 1000s allows you to use these terminals for the negative logic system.

## 4.6 Analog Output (FMA) Selector

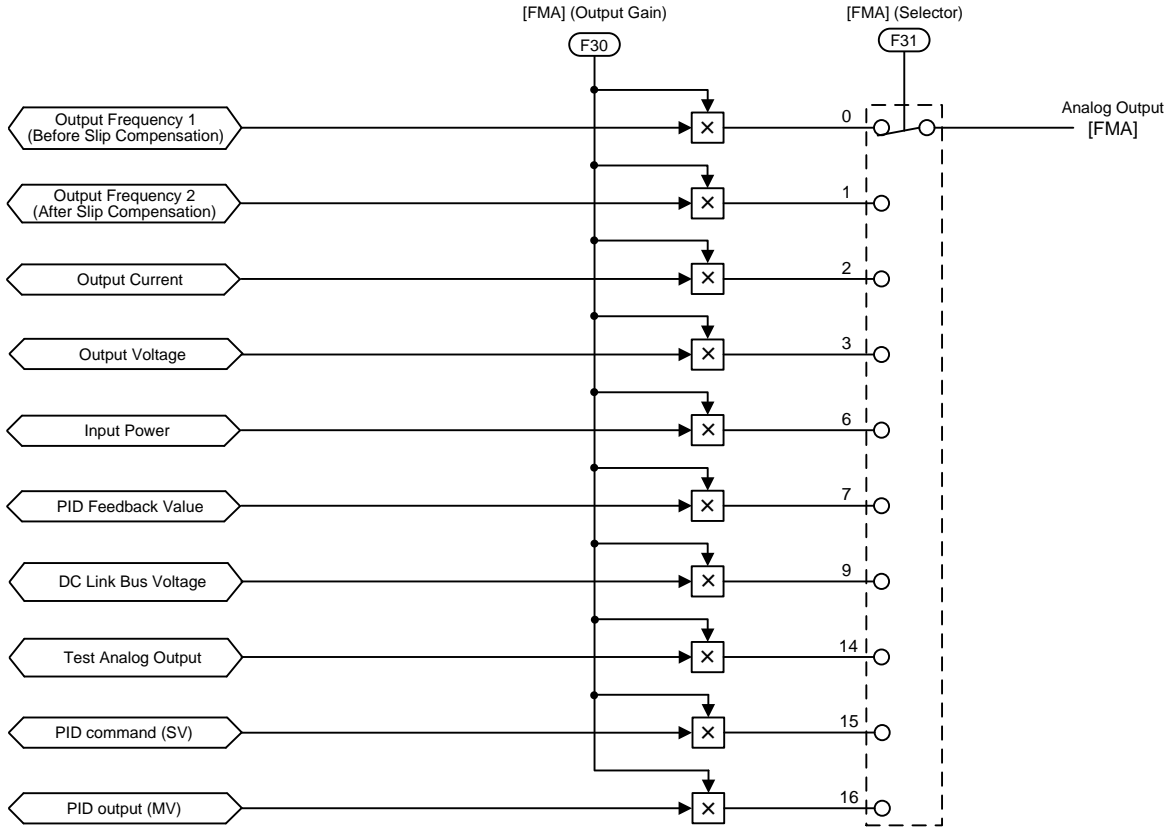

Figure 4.5 Analog Output (FMA) Selector

The block diagram shown in Figure 4.5 shows the process for selecting and processing the analog signals to be outputted to the analog output terminal [FMA]. Function code F31 determines the signals to be outputted to [FMA]. Function code F30 scales the output signal to a level suitable for the meters to be connected to the [FMA] terminal.

The output voltage range is 0 to 10 VDC and the maximum allowable load current is 2 mA. This is capable of driving two analog voltmeters with a common rating.

The test analog output is full-scale voltage output that adjusts the scale of the connected meter.

# 4.7 Drive Command Controller

Figures 4.6 (a) and (b) show the drive command controller.

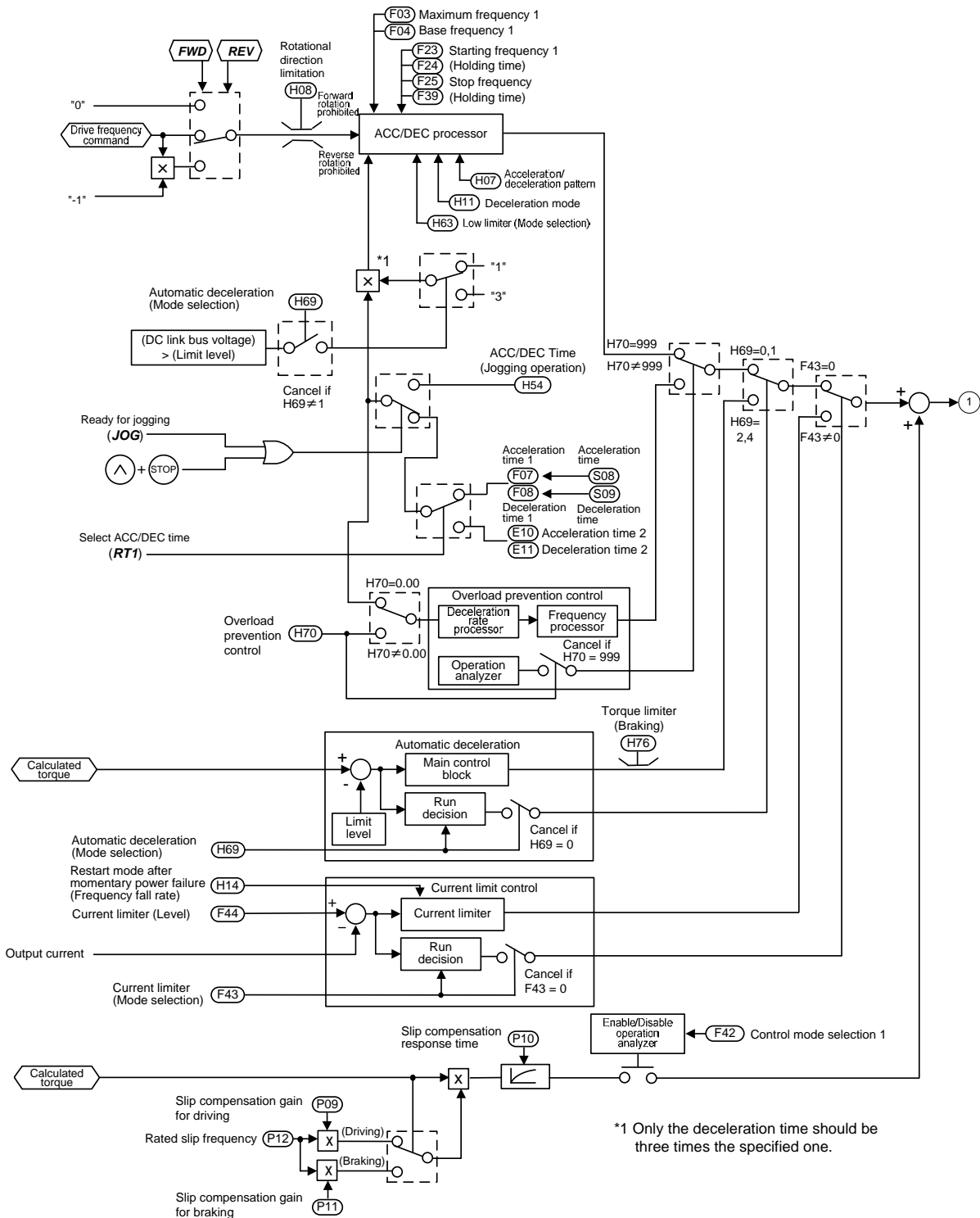

Figure 4.6 (a) Drive Command Controller and Related Part of the Inverter



The simplified block diagram shown in Figure 4.6 explains the process in which the inverter drives the motor according to the internal run command <FWD>/<REV> from the frequency generator, or the PID frequency command from the PID controller, and the run commands.

Additional and supplemental information is given below.

- The logic shown in the left part of the block diagram processes the drive frequency command so as to invert ( $\times(-1)$ ) the command for reverse rotation of the motor or to replace it with 0 (zero) for stopping the motor.
- The accelerator/decelerator processor determines the output frequency of the inverter by referring to the set data of related function codes. If the output frequency exceeds the peak frequency given by function code F15, the controller limits the output frequency at the peak.
- Acceleration/deceleration time is selectable from acceleration/deceleration time 1 or 2, or acceleration/deceleration time for jogging operation. The suppression of the regenerative braking feature may multiply the commanded acceleration/deceleration time by 3. Refer to role of function code H69 in the block diagram.
- If the overload prevention control feature is active, then the logic automatically switches the output frequency to one of overload suppression control and controls the inverter using the switched frequency. However, if the current limit control is active ( $F43 \neq 30$ ,  $H12 = 1$ ), the overload prevention control automatically becomes inactive.
- If the current limit control is active, then the logic automatically switches the output frequency to one of current limit control and controls inverter using the switched frequency.
- The slip compensation facility adds frequency components based on the preset rated slip frequency (P12) to the frequency currently commanded. The logic adjusts the error according to the settings of the slip compensation gain for driving (P09) and braking (P11).

the set data of function code P09 that controls slip compensation gain for the motor.

- The voltage processor determines the output voltage of the inverter. The processor adjusts the output voltage to control the motor output torque.
- If DC braking control is active, the logic switches the voltage and frequency control components to ones determined by the DC braking block to feed the proper power to the motor for DC braking.

# 4.8 PID Frequency Command Generator

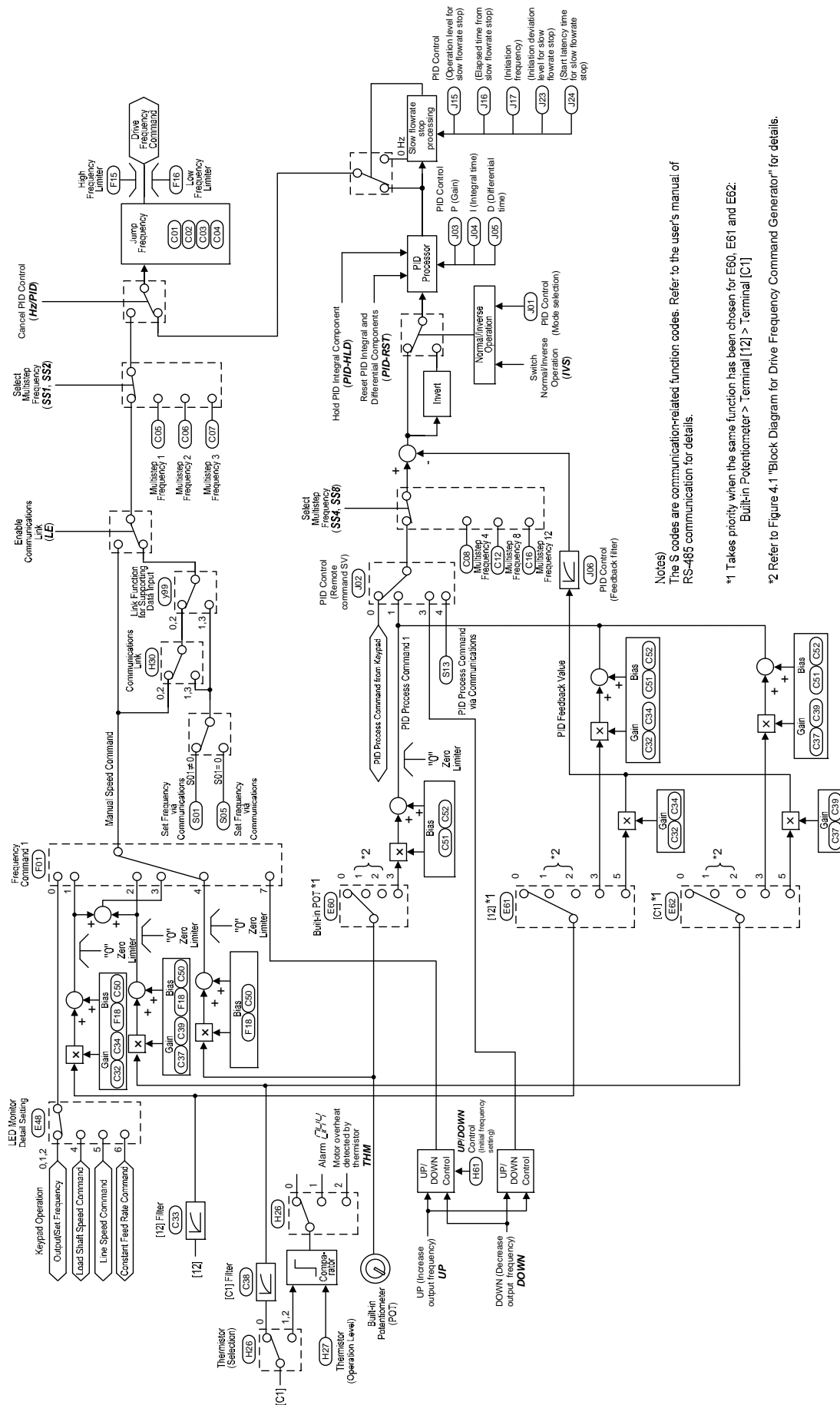

Notes  
 The S codes are communication-related function codes. Refer to the user's manual of RS-485 communication for details.

\*1 Takes priority when the same function has been chosen for E60, E61 and E62:  
 Built-in Potentiometer > Terminal [12] > Terminal [C1]

\*2 Refer to Figure 4.1 "Block Diagram for Drive Frequency Command Generator" for details.

Figure 4.7 PID Frequency Command Generator



The block diagram shown in Figure 4.7 shows the PID frequency command generator that becomes active when the PID control is enabled (J01= 1 or 2). The logic shown generates the final frequency command according to the PID process command given by various means of setting and feedback, or frequency settings as a speed command given manually, and various means of switching.

Additional and supplemental information is given below.

- Switching of data settings for frequency 2 (C30), auxiliary frequencies 1 and 2 (E60 to E62) as manual speed commands will be disabled.
- For multistep frequency settings, settings 1 to 3 are exclusively applicable to the manual PID speed command.
- For selecting analog input (terminal [12], [C1], or built-in POT) as the PID process command, you need to set proper data for function codes E60 to E62 and J02.
- Multistep frequencies that can be used as a PID process command include multistep frequency 4 (C08), 8 (C12) and 12 (C16).
- To switch the operation between normal and inverse, the logic inverses polarity of deviation between the PID command and its feedback (turning *INV* command ON/OFF, or setting J01 = 1 or 2).
- Refer to Section 4.2 " Drive Frequency Command Generator" for explanations of common items.



---

## Chapter 5

# RUNNING THROUGH RS-485 COMMUNICATIONS

This chapter describes an overview of inverter operation through the RS-485 communications link. Refer to the RS-485 Communication User's Manual (MEH448) for details.

### Contents

5.1	Overview on RS-485 Communication .....	5-1
5.1.1	Common specifications .....	5-2
5.1.2	Connector specifications .....	5-3
5.1.3	Connection .....	5-4
5.2	Overview of FRENIC Loader .....	5-5
5.2.1	Specifications .....	5-5
5.2.2	Connection .....	5-6
5.2.3	Function overview .....	5-6
5.2.3.1	Setting of function code .....	5-6
5.2.3.2	Running status monitor .....	5-7
5.2.3.3	Test-running .....	5-9



## 5.1 Overview on RS-485 Communication

Using the RS-485 communications port on the FRENIC-Mini series enables the following extended functions.

### ■ Operation from a remote keypad

Connecting a remote keypad to the RS-485 communications port on the inverter with an extension cable allows you to mount the keypad on the easy-to-access front of a panel. The maximum length of the extension cable is 20 m (66 ft.).

### ■ Operation by FRENIC Loader

The FRENIC-Mini can be connected to a Windows-based PC, on which you can run FRENIC Loader (see Section 5.2 "Overview of FRENIC Loader.") to edit the function code data and monitor the running status information of the inverter.

### ■ Operation from the host equipment

The FRENIC-Mini can be connected to host equipment (master) such as a PLC or computer. It can act as a slave device.

Protocols for managing a network including inverters include the Modbus RTU protocol (compliant to the protocol established by Modicon Inc.) that is widely used in FA markets and the Fuji general-purpose protocol that supports the FRENIC-Mini and conventional series of inverters.

 **Note** For the remote keypad, the inverter uses the dedicated protocol that automatically switches the operation source to the remote keypad, so no function code setting is required.  
For FRENIC loader, however, you need to set up function code H30 for some communications conditions although the dedicated protocol is used.

## 5.1.1 Common specifications

Items	Specifications		
Protocol	FGI-BUS	Modbus RTU	Loader protocol
Compliance	Fuji general-purpose RS-485 communication	Modicon Modbus RTU-compliant	Special commands dedicated to Loader (Not disclosed)
No. of supporting stations	Host device: 1 Inverters: Up to 31		
Max. transmission cable length	500 m (1600 ft.)		
No. of available station addresses	1 to 31	1 to 247	1 to 255
Synchronization	Start-Stop system		
Message frame format	FGI-BUS	Modbus RTU	Loader
Frame synchronization	Detection of SOH (Start Of Header) character	Detection of no-data transmission time for 3-byte period	Detection of header character (Start code 96H)
Transmission mode	Half-duplex		
Messaging system	Polling/Selecting/Broadcast		Command message
Transmission character format	ASCII	Binary	
Character length	8 or 7 bits (selectable by the function code)	8 bits (fixed)	
Parity	Even, Odd, or None (selectable by the function code)		Even
Stop bit length	1 or 2 bits (selectable by the function code)	When "No parity" is selected: 2 bits When Even or Odd parity is selected: 1 bit	1 bit (fixed)
Error checking	Sum-check	CRC-16	Sum-check
Transmission speed	2400, 4800, 9600, 19200, or 38400 bps		2400 or 4800 bps

### 5.1.2 Connector specifications

The RS-485 communications port uses an RJ-45 connector whose pin assignment is listed in the table below.

Pin	Signal name	Function	Remarks
1 and 8	Vcc	Power source for the remote keypad	5V
2 and 7	GND	Reference voltage level	GND
3 and 6	NC	No connection	--
4	DX-	RS-485 communication data (-)	Built-in terminating resistor: 112 Ω
5	DX+	RS-485 communication data (+)	Open/close switchable by SW3

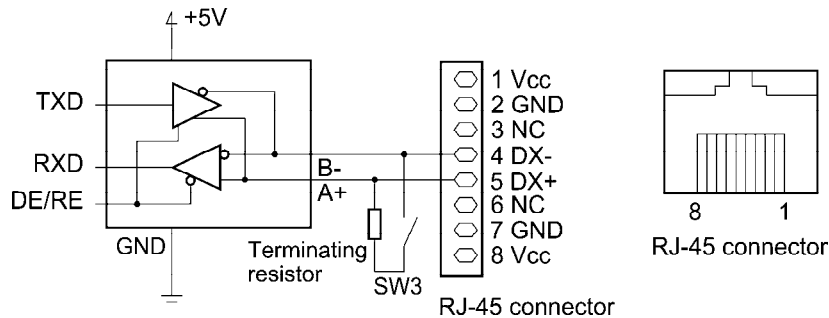
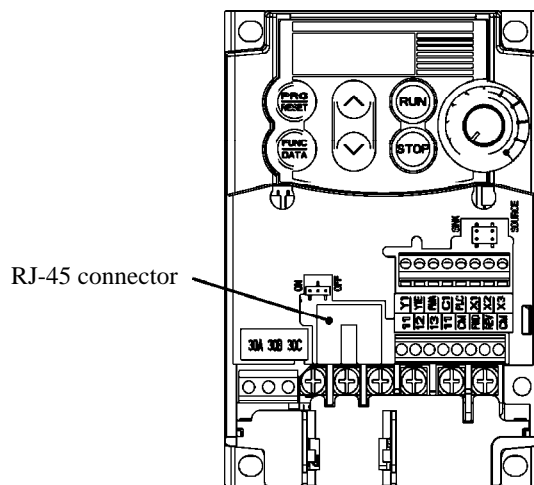

**Note** The RJ-45 connector has power source pins (pins 1 and 8) designed for the remote keypad. When connecting other devices to the RJ-45 connector, take care not to use those pins.

For the details about the terminating resistor switch, refer to the FRENIC-Mini Instruction Manual, Section 2.3.7 "Setting up the slide switches."

When connecting a remote keypad, it is not necessary to turn the terminating resistor switch ON.

### 5.1.3 Connection

You need to select devices suitable for your network configuration, referring to the figure shown below.

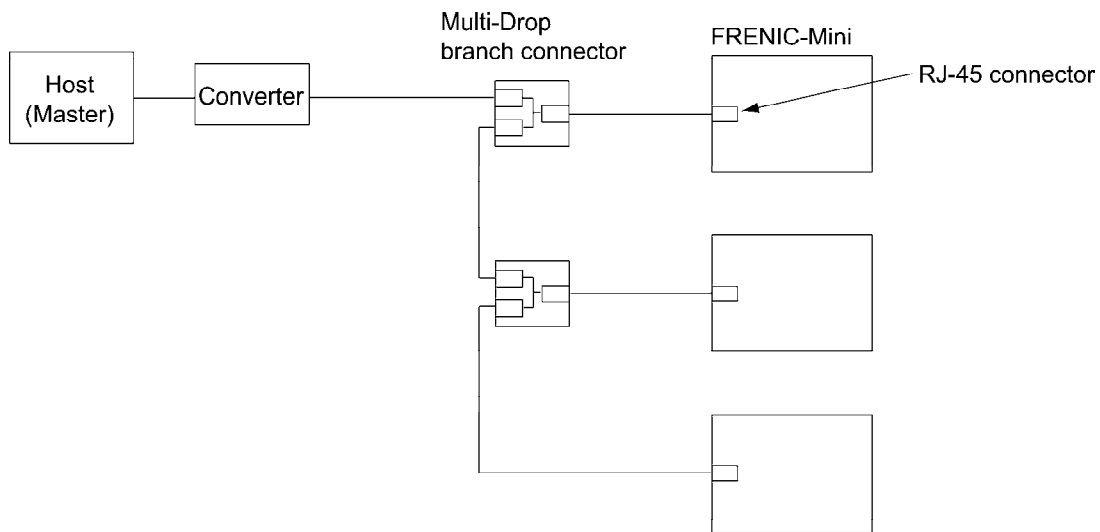

#### Converter

Some computers are not equipped with an RS-485 communications port but with a USB port, so a USB/RS-485 converter is required to connect them to the RS-485 communications port on the inverter. It is recommended that insulated converters such as RS-485/RS-485 converters be used for eliminating electric noise.

#### Multi-drop branch connector

The RS-485 communications port on the FRENIC-Mini uses an RJ-45 connector. For multi-drop connection of inverters, therefore, multi-drop branch connectors (MS8-BA-JJJ by SK Koki Co.) are required.

#### Cable

For the connection of the remote keypad, use an 8-wire straight cable with an RJ-45 connector. (Remote keypad extension cable option: CB-5S)

For the connection of other equipment or connection of FRENIC-Mini inverters with each other, use a cable that has signal wires only. (EIA568-compliant 10BASE-T)

- Note**
- No converter is required for connection of the remote keypad.
  - To connect the FVR-E11S series of general-purpose inverters to the FRENIC-Mini series, take necessary measures for the difference of the pin assignment between FVR-E11S and FRENIC-Mini series to avoid a short-circuited failure.



## 5.2 Overview of FRENIC Loader

FRENIC Loader is a software tool that supports the operation of the inverter via an RS-485 communications link. It allows you to remotely run or stop the inverter, edit, set, or manage the function codes, monitor key parameters and values during operation, as well as monitoring the running status (including alarm information) of the inverters on the RS-485 communications network.

 For details, refer to the FRENIC Loader Instruction Manual.

### 5.2.1 Specifications

Item	Specifications (White on black indicates factory default)	Remarks	
Name of software	FRENIC Loader		
Supported inverter	FRENIC-MEGA/Multi/Eco/Mini	(Note 1)	
No. of supported inverters	When connected to RS-485 communications ports: Up to 31		
Recommended cable	10BASE-T cable with RJ-45 connectors compliant with EIA568	For the RS-485 interface	
Operating environment	CPU	Intel Pentium III 600 MHz or later (Note 2)	
	OS	Microsoft Windows XP (32-bit) Microsoft Vista (32-bit) Microsoft 7 (32-bit, 64-bit)	
	Memory	512 MB or more RAM	1GB or more recommended
	Hard disk	20 MB or more free space	
	COM port	USB or RS-232C (conversion to RS-485 communication required to connect inverters)	
	Monitor resolution	800 x 600 or higher	XGA (1024 x 768), 16-bit color or higher is recommended
Transmission requirements	COM port	COM1 to COM255	PC COM ports assigned to Loader
	Transmission rate	USB connection: Between loader and keypad = fixed at 12 Mbps Between keypad and inverter = fixed at 19200 bps RS-485 connection: 38400, 19200, 9600, 4800, 2400 (bps)	19200 bps or more is recommended.
	Character length	8 bits	Prefixed
	Stop bit length	1 bit	Prefixed
	Parity	Even	Prefixed
	No. of retries	None, 1 to 10	No. of retry times before detecting communications error
Timeout setting	(100 ms, 300 ms, 500 ms), (1.0 to 1.5 to 1.9 s), (2.0 to 9.0 s) or (10.0 to 60.0 s)	This setting should be longer than the response interval time specified by function code y09 of the inverter.	

- (Note 1) • FRENIC Loader cannot be used with inverters that do not support SX protocol (protocol for handling Loader commands).  
• Inverters other than standard series may not display function code data normally.

- (Note 2) Use a PC with as high a performance as possible, since some slow PCs may not properly refresh the operation status monitor and Test-run windows.

## 5.2.2 Connection

By connecting a number of inverters to one PC, you can control one inverter at a time or a number of inverters simultaneously. You can also simultaneously monitor a number of inverters on the multi-monitor.

 For instructions on how to connect inverters to a PC, refer to Section 5.1.3 "Connection" in this manual and the RS-485 Communication User's Manual (MEH448).

## 5.2.3 Function overview

### 5.2.3.1 Setting of function code

You can set, edit, and check the setting of the inverter's function code data.

#### List and Edit

In List and edit, you can list and edit function codes with function code No., name, set value, set range, and factory default.

You can also list function codes by any of the following groups according to your needs:

- Function code group
- Function codes that have been modified from their factory defaults
- Result of comparison with the settings of the inverter
- Result of search by function code name
- User-specified function code set

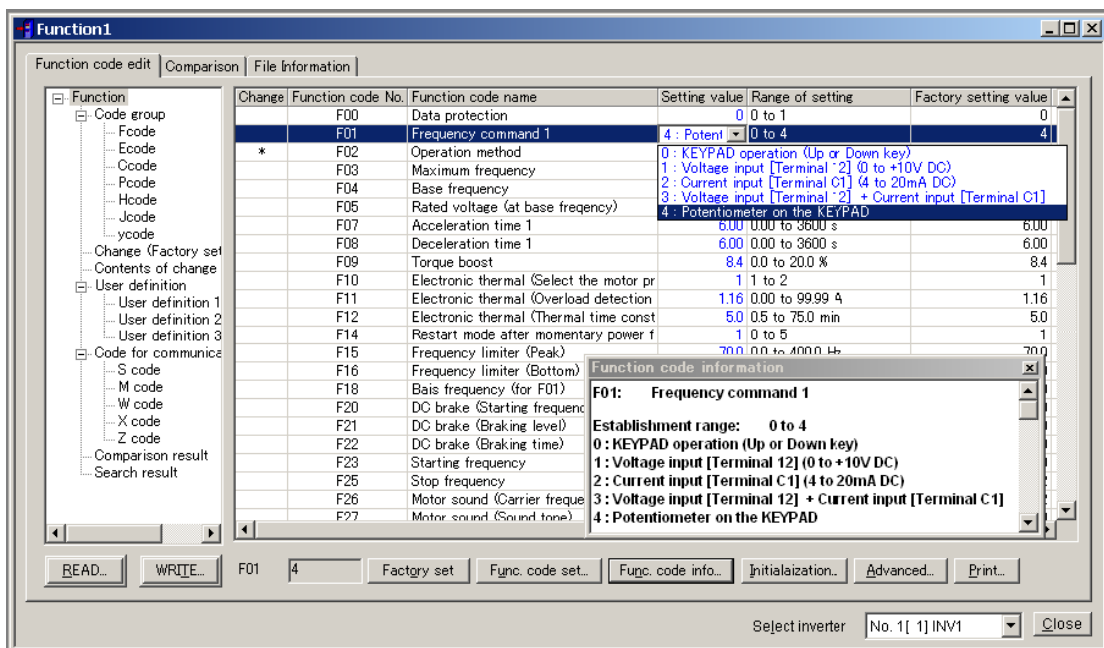

**Comparison**

You can compare the function code data currently being edited with that saved in a file or stored in the inverter.

To perform a comparison and review the result displayed, click the **Comparison** tab and then click the **Compared with inverter** tab or click the **Compared with file** tab, and specify the file name.

The result of the comparison will be displayed also in the Comparison Result column of the list.

**File information**

Clicking the **File information** tab displays the property and comments for identifying the function code editing file.

(1) Property

Shows file name, inverter model, inverter’s capacity, date of readout, etc.

(2) Comments

Displays the comments you have entered. You can write any comments necessary for identifying the file.

**5.2.3.2 Running status monitor**

The running status monitor offers five monitor functions: Multi-monitor, I/O monitor, System monitor, Alarm monitor, and Meter display. You can choose an appropriate monitoring format according to the purpose and situation.

**Multi-monitor**

Allows you to monitor the status of more than one inverter in a list format.

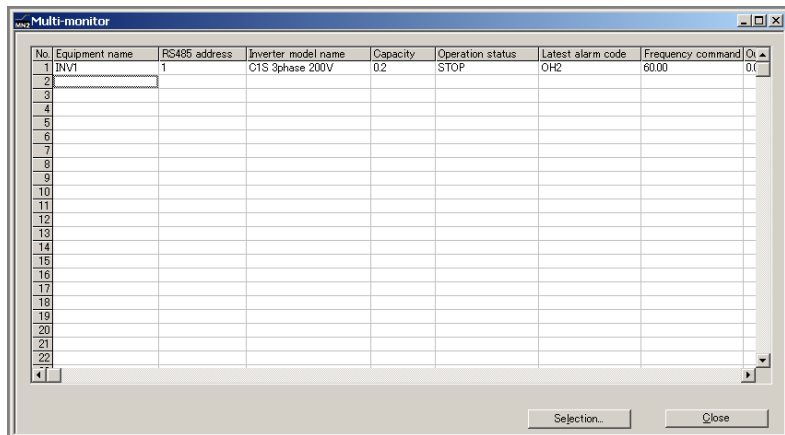

**I/O monitor**

Allows you to monitor the ON/OFF states of the digital input signals to the inverter and the transistor output signals.

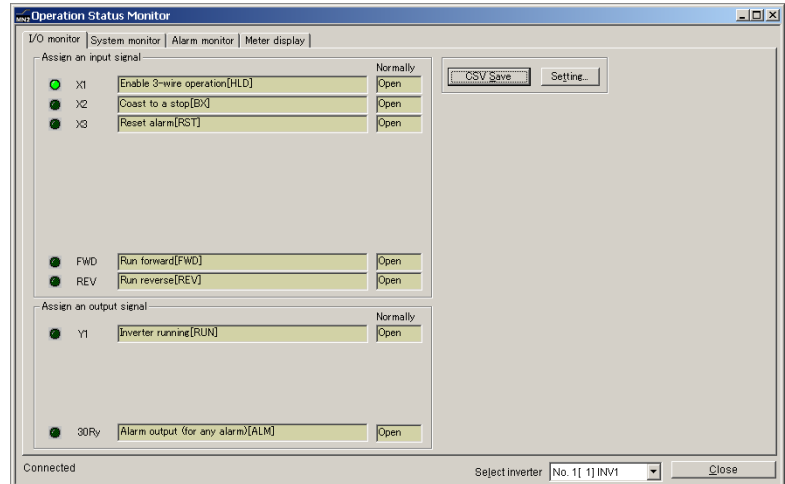

## System monitor

Allows you to check the inverter's system information (version, model, maintenance information, etc.).

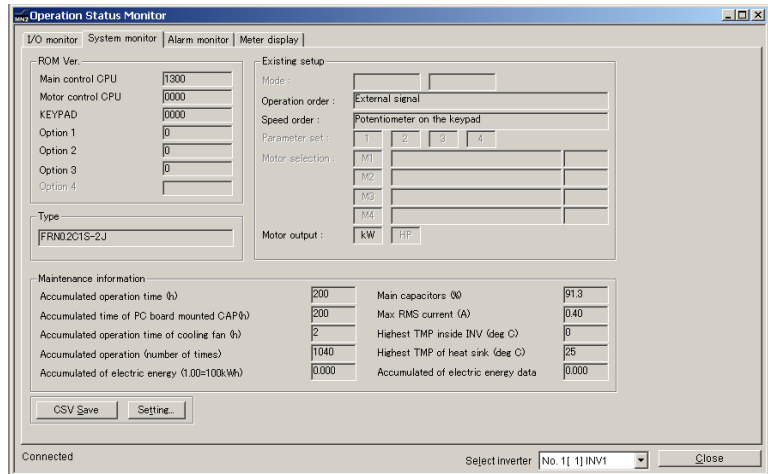

## Alarm monitor

The alarm monitor shows the alarm status of the selected inverter. In this window, you can check the details of the alarm that currently occurs and the related information.

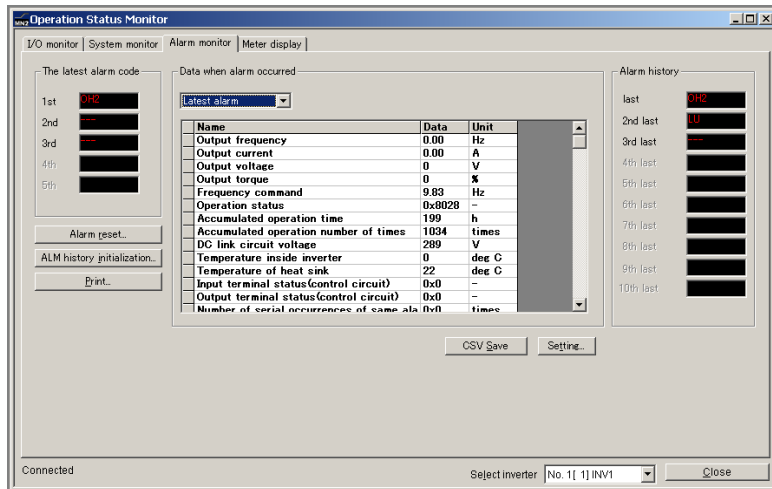

## Meter display

Displays analog readouts of the selected inverter (such as output frequency) on analog meters. The example on the right displays the reference frequency and the output frequency.

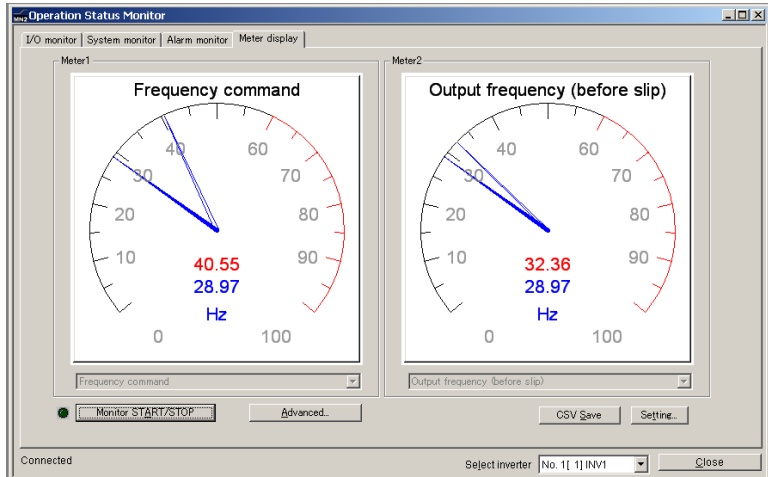

### 5.2.3.3 Test-running

The test-running feature allows you to test-run the motor in the forward or reverse direction while monitoring the running status of the selected inverter.

The screenshot shows the 'Test run' window with several callouts:

- LED monitor**: Shows the running status (output frequency, current, etc.).
- Reference frequency**: Points to the 'Frequency reference' field set to 25.68 Hz.
- Operation status**: Shows FWD, REV, STOP and alarm codes. The LED display shows '60.00' Hz and 'FWD'.
- Operation buttons**: Points to the STOP, FWD, RESET, and REV buttons.
- Select monitor item**: Select the operation status information to be monitored in real-time. Points to the 'Select monitor item' dropdown.
- Select the frequency and run command sources and click Apply.**: Points to the 'Frequency reference' and 'Apply' buttons.

The interface includes a 'Select monitor item' dropdown with 'Output frequency (before slip)' selected. The 'Frequency reference' is 25.68 Hz. The 'Select monitor item' dropdown has 'Frequency command' selected, showing 60.00 Hz. Other monitored values are Output current: 0.27 A and Output voltage: 205.0V. The 'Switch of Freq. reference, Ope. command' is set to '3: Freq. = Loader, Ope. = Loader'. The 'Assign an input signal' table is as follows:

		Normally
X1	Enable 3-wire operation(HLD)	Open
X2	Coast to a stop(BX)	Open
X3	Reset alarm(RST)	Open
FWD	Run forward(FWD)	Open
REV	Select multi-Frequency(SS1)	Open



# Chapter 6

## SELECTING PERIPHERAL EQUIPMENT

This chapter describes how to use a range of peripheral equipment and options, FRENIC-Mini's configuration with them, and requirements and precautions for selecting wires and crimp terminals.

### Contents

6.1	Configuring the FRENIC-Mini .....	6-1
6.2	Selecting Wires and Crimp Terminals .....	6-2
6.2.1	Recommended wires .....	6-4
6.2.2	Crimp terminals .....	6-12
6.3	Peripheral Equipment .....	6-13
[ 1 ]	Molded case circuit breaker (MCCB), earth leakage circuit breaker (ELCB) and magnetic contactor (MC) .....	6-13
[ 2 ]	Surge killers .....	6-17
[ 3 ]	Arresters .....	6-18
[ 4 ]	Surge absorbers .....	6-19
6.4	Selecting Options .....	6-20
6.4.1	Peripheral equipment options .....	6-20
[ 1 ]	Braking resistors .....	6-20
[ 2 ]	DC reactors (DCRs) .....	6-24
[ 3 ]	AC reactors (ACRs) .....	6-26
[ 4 ]	Output circuit filters (OFLs) .....	6-28
[ 5 ]	Surge suppression unit (SSU) .....	6-30
[ 6 ]	Zero-phase reactors for reducing radio noise (ACLs) .....	6-31
[ 7 ]	Options for 100 V single-phase power supply .....	6-32
6.4.2	Options for operation and communications .....	6-33
[ 1 ]	External potentiometer for frequency setting .....	6-33
[ 2 ]	Remote keypad "TP-E1" .....	6-34
[ 3 ]	USB-equipped remote keypad (TP-E1U) .....	6-35
[ 4 ]	Extension cable for remote operation (CB-□S) .....	6-36
[ 5 ]	Inverter support loader software .....	6-36
6.4.3	Extended installation kit options .....	6-37
[ 1 ]	Mounting adapters .....	6-37
[ 2 ]	Rail mounting bases .....	6-38
[ 3 ]	NEMA1 kit (NEMA1-□□□C2-□ ) .....	6-39
6.4.4	Meter options .....	6-40
[ 1 ]	Frequency meters .....	6-40





## 6.1 Configuring the FRENIC-Mini

This section lists the names and features of peripheral equipment and options for the FRENIC-Mini series of inverters and includes a configuration example for reference. Refer to Figure 6.1 for a quick overview of available options.

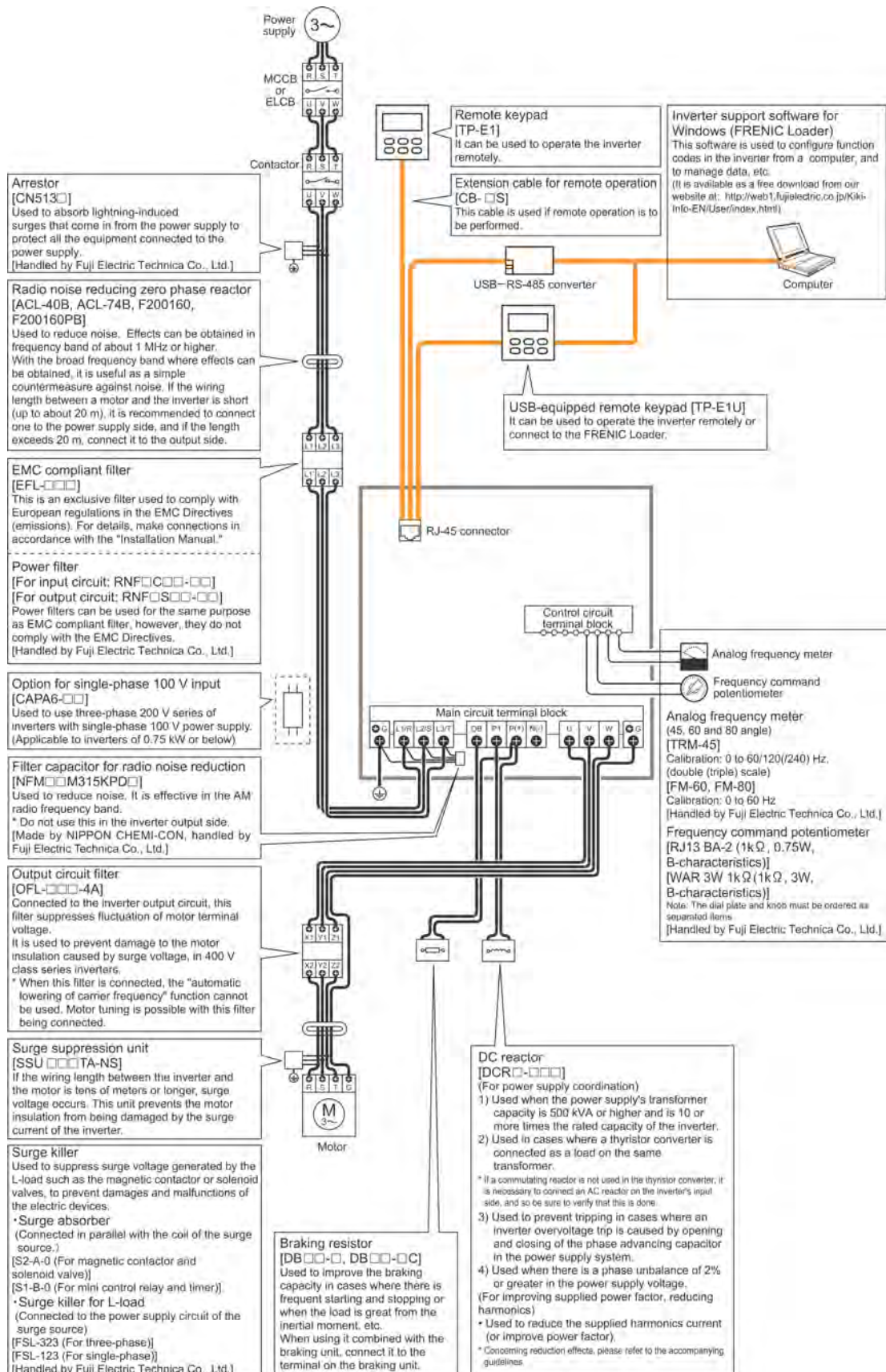

Figure 6.1 Quick Overview of Options

---

## 6.2 Selecting Wires and Crimp Terminals

This section contains information needed to select wires for connecting the inverter to commercial power lines, motor or any of the optional/peripheral equipment. The level of electric noise issued from the inverter or received by the inverter from external sources may vary depending upon wiring and routing. To solve such noise-related problems, refer to Appendix A "Advantageous Use of Inverters (Notes on electrical noise)" in this manual and the Inverter Panel Design Technical Document. At the time of actual construction, refer to the FRENIC-Mini Instruction Manual, Chapter 2 "Mounting and Wiring of the Inverter," Wiring precautions.

Select wires that satisfy the following requirements:

- Sufficient capacity to flow the rated average current (allowable current capacity).
- Protective device coordination with a molded case circuit breaker (MCCB) and residual-current-operated protective device (RCD)/earth leakage circuit breaker (ELCB) with overcurrent protection in the overcurrent zone for overcurrent protection.
- Voltage loss due to the wire length is within the allowable range.
- Suitable for the type and size of terminals of the optional equipment to be used.

Recommended wires are listed below. Use these wires unless otherwise specified.

### ■ 600V class of vinyl-insulated wires (IV wires)

Use this class of wire for the power circuits. This class of wire is hard to twist, so using it for the control signal circuits is not recommended. Maximum ambient temperature for this wire is 60°C (140°F).

### ■ 600V heat-resistant PVC insulated wires or 600V polyethylene insulated wires (HIV wires)

As wires in this class are smaller in diameter and more flexible than IV wires and can be used at a higher ambient temperature (75°C (167°F)), they can be used for both of the main power and control signal circuits. To use this class of wire for the control circuits, you need to correctly twist the wires and keep the wiring length for equipment being connected as short as possible.

### ■ 600V cross-linked polyethylene-insulated wires (FSLC wires)

Use this class of wire mainly for power and grounding circuits. These wires are smaller in diameter and more flexible than those of the IV and HIV classes of wires, meaning that these wires can be used to save on space and increase operation efficiency of your power system, even in high temperature environments. The maximum allowable ambient temperature for this class of wires is 90°C (194°F). The Boardlex available from Furukawa Electric Co., Ltd. satisfies these requirements.

### ■ Shielded-Twisted cables for internal wiring of electronic/electric equipment

Use this category of cables for the control circuits of the inverter so as to prevent the signal lines from being affected by noise from external sources, including the power input/output lines of the inverter themselves. Even if the signal lines are inside the power control cabinet, always use this category of cables when the length of wiring is longer than normal. Cables satisfying these requirements are the Furukawa's BEAMEX S shielded cables of the XEBV and XEWV ranges.

Currents Flowing across the Inverter Terminals

Table 6.1 summarizes average (effective) electric currents flowing across the terminals of each inverter model for ease of reference when selecting peripheral equipment, options and electric wires for each inverter—including supplied power voltage and applicable motor rating.

Table 6.1 Currents Flowing through Inverter

Power supply voltage	Applicable motor (kW)	Applicable motor (HP)	50Hz, 200V / 400V (380V)				60Hz, 220V (200V) / 440V (380V)			
			Input RMS current (A)		DC link bus current (A)	Braking resistor circuit current (A)	Input RMS current (A)		DC link bus current (A)	Braking resistor circuit current (A)
			DC reactor (DCR) w/ DCR	DC reactor (DCR) w/o DCR			DC reactor (DCR) w/ DCR	DC reactor (DCR) w/o DCR		
Three-Phase 200V	0.1	1/8	0.57	1.1	0.70	-	0.51 (0.55)	1.1 (1.1)	0.62 (0.67)	-
	0.2	1/4	0.93	1.8	1.1	-	0.85 (0.92)	1.7 (1.8)	1.0 (1.1)	-
	0.4	1/2	1.6	3.1	2.0	1.2	1.5 (1.6)	3.0 (3.0)	1.8 (2.0)	1.2
	0.75	1	3.0	5.3	3.7	1.6	2.8 (3.0)	5.0 (5.3)	3.4 (3.7)	1.6
	1.5	2	5.7	9.5	7.0	3.6	5.2 (5.6)	9.0 (9.5)	6.3 (6.9)	3.6
	2.2	3	8.3	13.2	10.2	3.5	7.6 (8.3)	12.3 (13.2)	9.3 (10.1)	3.5
	3.7	5	14.0	22.2	17.2	4.1	12.7 (13.9)	20.6 (22.2)	15.6 (17.0)	4.1
	5.5	7.5	21.1	31.5	25.9	6.4	19.0 (20.9)	28.4 (31.2)	23.3 (25.6)	6.4
	7.5	10	28.8	42.7	35.3	6.1	26.0 (28.6)	38.5 (42.3)	31.9 (35.1)	6.1
	11	15	42.2	60.7	51.7	9.1	38.0 (41.8)	54.7 (60.1)	46.6 (51.2)	9.1
15	20	57.6	80.0	70.6	11.0	52.0 (57.1)	72.2 (79.4)	63.7 (70.0)	11.0	
Three-Phase 400V	0.4	1/2	0.81 (0.85)	1.6 (1.7)	0.99 (1.0)	0.8	0.74 (0.85)	1.7 (1.7)	0.91 (1.0)	0.8
	0.75	1	1.5 (1.6)	2.9 (3.0)	1.8 (1.9)	1.1	1.4 (1.6)	3.0 (3.0)	1.7 (2.0)	1.1
	1.5	2	2.9 (3.0)	5.7 (5.7)	3.5 (3.6)	1.8	2.6 (3.0)	5.1 (5.9)	3.2 (3.6)	1.8
	2.2	3	4.2 (4.4)	7.9 (7.9)	5.1 (5.3)	1.8	3.8 (4.3)	7.1 (8.2)	4.6 (5.3)	1.8
	3.7	5	7.0 (7.3)	12.5 (13.0)	8.6 (9.0)	2.1	6.4 (7.3)	11.1 (12.9)	7.8 (8.9)	2.1
	5.5	7.5	10.6 (11.2)	17.3 (18.2)	13.0 (13.7)	3.2	9.6 (11.1)	15.7 (18.2)	11.8 (13.7)	3.2
	7.5	10	14.4 (15.2)	23.2 (24.2)	17.7 (18.6)	3.1	13.0 (15.1)	21.0 (24.3)	16.0 (18.5)	3.1
11	15	21.1 (22.2)	33.0 (34.7)	25.9 (27.3)	4.5	19.0 (22.0)	29.8 (34.5)	23.3 (27.0)	4.5	
15	20	28.8 (30.3)	43.8 (46.1)	35.3 (37.2)	5.7	26.0 (30.1)	39.5 (45.7)	31.9 (36.9)	5.7	
Single-Phase 200V	0.1	1/8	1.1	1.8	1.1	-	1.0 (1.1)	1.8 (1.8)	1.0 (1.1)	-
	0.2	1/4	2.0	3.2	2.0	-	1.8 (1.9)	3.1 (3.2)	1.8 (1.9)	-
	0.4	1/2	3.5	5.2	3.5	0.82	3.1 (3.4)	5.0 (5.4)	3.1 (3.4)	0.82
	0.75	1	6.4	9.5	6.4	1.4	5.8 (6.3)	9.1 (9.7)	5.8 (6.3)	1.4
	1.5	2	11.7	16.0	11.7	1.4	10.5 (11.3)	15.5 (16.4)	10.5 (11.3)	1.4
	2.2	3	17.5	24.2	17.5	1.7	15.8 (17.0)	23.4 (24.8)	15.8 (17.0)	1.7
Single-Phase 100V	0.1	1/8	2.1	3.5	-	-	2.1 (2.3)	3.6 (4.0)	2.1 (2.3)	-
	0.2	1/4	3.8	5.8	-	-	3.7 (4.1)	5.9 (6.5)	3.7 (4.1)	-
	0.4	1/2	6.4	9.4	-	0.82	6.3 (6.9)	9.5 (10.5)	6.3 (6.9)	-
	0.75	1	12.0	16.0	-	1.4	11.6 (12.8)	16.1 (17.7)	11.6 (12.8)	-

- Inverter efficiency is calculated using values suitable for each inverter model. The input route mean square (RMS) current is calculated according to the following conditions:  
Power source capacity: 500 kVA; power source internal impedance: 5%
- The current listed in the above table will vary in inverse proportion to the power supply voltage, such as 230 VAC and 460 VAC.
- The braking current is always constant, independent of braking resistor type (standard and 10%ED).

## 6.2.1 Recommended wires

Tables 6.2 and 6.3 list the recommended wires according to the internal temperature of your power control cabinet.

■ If the internal temperature of your power control cabinet is 50°C (122°F) or below

Table 6.2 Wire Size (kW, mm<sup>2</sup> ratings) (for main circuit power input and inverter output)

Power supply voltage	Applicable motor rating (kW)	Inverter type	Recommended wire size (mm <sup>2</sup> ) at 50°C (122°F) or below										
			Main circuit power input [L1/R, L2/S, L3/T] or [L1/L, L2/N]						Inverter output [U, V, W]				
			w/ DC reactor (DCR)			w/o DC reactor (DCR)			Allowable temp.*1			Current (A)	
			60°C	75°C	90°C	Current (A)	60°C	75°C	90°C	Current (A)	60°C	75°C	90°C
Three-phase 200 V	0.1	FRN0001C2S-2□	2.0 (2.5)	2.0 (2.5)	2.0 (2.5)	0.57	2.0 (2.5)	2.0 (2.5)	1.1	2.0 (2.5)	2.0 (2.5)	2.0 (2.5)	0.8
	0.2	FRN0002C2S-2□				0.93			1.8				1.5
	0.4	FRN0004C2S-2□				1.6			3.1				3.0
	0.75	FRN0006C2S-2□				3.0			5.3				5.5
	1.5	FRN0010C2S-2□				5.7			9.5				8.0
	2.2	FRN0012C2S-2□				8.3			13.2				11
	3.7	FRN0020C2S-2□				14.0			22.2				17
	5.5	FRN0025C2S-2□				21.1			31.5				25
	7.5	FRN0033C2S-2□				28.8			42.7				33
	11	FRN0047C2S-2□				42.2			60.7				47
15	FRN0060C2S-2□	57.6	80.1	60									
Three-phase 400 V	0.4	FRN0002C2■-4□	2.0 (2.5)	2.0 (2.5)	2.0 (2.5)	0.85	2.0 (2.5)	2.0 (2.5)	1.7	2.0 (2.5)	2.0 (2.5)	2.0 (2.5)	1.5
	0.75	FRN0004C2■-4□				1.6			3.1				2.5
	1.5	FRN0005C2■-4□				3.0			5.9				3.7
	2.2	FRN0007C2■-4□				4.4			8.2				5.5
	3.7/4.0	FRN0011C2■-4□				7.3			13.0				9
	5.5	FRN0013C2■-4□				11.2			18.2				13
	7.5	FRN0018C2■-4□				15.2			24.2				18
	11	FRN0024C2■-4□				22.2			34.7				24
15	FRN0030C2■-4□	30.3	46.1	30									
Single-phase 200 V	0.1	FRN0001C2■-7□	2.0 (2.5)	2.0 (2.5)	2.0 (2.5)	1.1	2.0 (2.5)	2.0 (2.5)	1.8	2.0 (2.5)	2.0 (2.5)	2.0 (2.5)	0.8
	0.2	FRN0002C2■-7□				2.0			3.3				1.5
	0.4	FRN0004C2■-7□				3.5			5.4				3.0
	0.75	FRN0006C2■-7□				6.4			9.7				5.0
	1.5	FRN0010C2■-7□				11.7			16.4				8.0
	2.2	FRN0012C2■-7□				17.5			24.8				11
Single-phase 100 V	0.1	FRN0001C2S-6U	2.0 (2.5)	2.0 (2.5)	2.0 (2.5)	2.1	2.0 (2.5)	2.0 (2.5)	3.5	2.0 (2.5)	2.0 (2.5)	2.0 (2.5)	0.7
	0.2	FRN0002C2S-6U				3.8			5.8				1.4
	0.4	FRN0003C2S-6U				6.4			9.4				2.5
	0.75	FRN0005C2S-6U				12.0			16.0				4.2

\*1 Assuming the use of bare wiring (without rack or duct): 600 V class of vinyl-insulated IV wires for 60°C, 600 V class of polyethylene-insulated HIV wires for 75°C, and 600 V class of polyethylene-insulated cross-link wires for 90°C.

Notes: 1) A box (□) in the above table replaces A, C, E, or U depending on shipping destination.

2) A box (■) in the above table replaces S (Basic type) or E (EMC filter built-in type) depending on the enclosure.

3) Values in parentheses ( ) in the above table denote wire sizes for the European version.



If environmental requirements such as power supply voltage and ambient temperature differ from those listed above, select wires suitable for your system by referring to Table 6.1 and Appendices, App. F "Allowable Current of Insulated Wires."

Table 6.2 Cont. (kW, mm<sup>2</sup> ratings) (for DC reactor, braking resistor, control circuits, and inverter grounding)

Power supply voltage	Applicable motor rating (kW)	Inverter type	Recommended wire size (mm <sup>2</sup> ) at 50°C (122°F) or below													
			DC reactor [P1, P(+)]			Braking resistor [P(+), DB]				Control circuit			Inverter grounding Ⓢ[G]			
			Allowable temp.*1		Current (A)	Allowable temp.*1		Current (A)	Allowable temp.*1			Allowable temp.*1				
			60°C	75°C		90°C	60°C		75°C	90°C	60°C	75°C	90°C	60°C	75°C	90°C
Three-phase 200 V	0.1	FRN0001C2S-2□				0.7										
	0.2	FRN0002C2S-2□				1.1	-	-	-	-						
	0.4	FRN0004C2S-2□	2.0 (2.5)	2.0 (2.5)	2.0 (2.5)	2.0	2.0 (2.5)	2.0 (2.5)	2.0 (2.5)	2.0 (2.5)	2.0 (2.5)	2.0 (2.5)	2.0 (2.5)	2.0 (2.5)	2.0 (2.5)	2.0 (2.5)
	0.75	FRN0006C2S-2□				3.7										
	1.5	FRN0010C2S-2□				7.0										
	2.2	FRN0012C2S-2□				10.2										
	3.7	FRN0020C2S-2□	3.5 (4.0)			17.2					0.5	0.5	0.5			
	5.5	FRN0025C2S-2□	5.5 (6)	3.5 (4)		25.9	2.0 (2.5)	2.0 (2.5)	2.0 (2.5)	2.0 (2.5)	2.0 (2.5)	2.0 (2.5)	2.0 (2.5)	3.5 (4)	3.5 (4)	3.5 (4)
	7.5	FRN0033C2S-2□	14 (16)	5.5 (6)	3.5 (4)	35.3								5.5 (6)	5.5 (6)	5.5 (6)
	11	FRN0047C2S-2□	22 (25)	8 (10)	5.5 (6)	51.7								8 (10)	8 (10)	8 (10)
15	FRN0060C2S-2□	38 (50)	14 (16)	14 (16)	70.6											
Three-phase 400 V	0.4	FRN0002C2■-4□				1.0										
	0.75	FRN0004C2■-4□				1.9										
	1.5	FRN0005C2■-4□	2.0 (2.5)	2.0 (2.5)	2.0 (2.5)	3.6	2.0 (2.5)	2.0 (2.5)	2.0 (2.5)	2.0 (2.5)	2.0 (2.5)	2.0 (2.5)	2.0 (2.5)	2.0 (2.5)	2.0 (2.5)	2.0 (2.5)
	2.2	FRN0007C2■-4□				5.3										
	3.7/4.0	FRN0011C2■-4□				9.0										
	5.5	FRN0013C2■-4□				13.0	2.0 (2.5)	2.0 (2.5)	2.0 (2.5)	2.0 (2.5)	2.0 (2.5)	2.0 (2.5)	2.0 (2.5)	3.5 (4)	3.5 (4)	3.5 (4)
	7.5	FRN0018C2■-4□	3.5 (4)			17.7					0.5	0.5	0.5			
11	FRN0024C2■-4□	5.5 (6)	3.5 (4)		25.9								3.5 (4)	3.5 (4)	3.5 (4)	
15	FRN0030C2■-4□	14 (16)	5.5 (6)	3.5 (4)	35.3											
Single-phase 200 V	0.1	FRN0001C2■-7□				1.1										
	0.2	FRN0002C2■-7□				2.0	-	-	-	-						
	0.4	FRN0004C2■-7□	2.0 (2.5)	2.0 (2.5)	2.0 (2.5)	3.5	2.0 (2.5)	2.0 (2.5)	2.0 (2.5)	2.0 (2.5)	2.0 (2.5)	2.0 (2.5)	2.0 (2.5)	2.0 (2.5)	2.0 (2.5)	2.0 (2.5)
	0.75	FRN0006C2■-7□				6.4										
	1.5	FRN0010C2■-7□				11.7										
2.2	FRN0012C2■-7□	3.5 (4.0)			17.5								3.5 (4.0)			
Single-phase 100 V	0.1	FRN0001C2S-6U														
	0.2	FRN0002C2S-6U														
	0.4	FRN0003C2S-6U														
	0.75	FRN0005C2S-6U														

\*1 Assuming the use of bare wiring (without rack or duct): 600 V class of vinyl-insulated IV wires for 60°C, 600 V class of polyethylene-insulated HIV wires for 75°C, and 600 V class of polyethylene-insulated cross-link wires for 90°C.

- Notes: 1) A box (□) in the above table replaces A, C, E, or U depending on shipping destination.  
 2) A box (■) in the above table replaces S (Basic type) or E (EMC filter built-in type) depending on the enclosure.  
 3) Values in parentheses ( ) in the above table denote wire sizes for the European version.

 If environmental requirements such as power supply voltage and ambient temperature differ from those listed above, select wires suitable for your system by referring to Table 6.1 and Appendices, App. F "Allowable Current of Insulated Wires."

Table 6.2 Cont. Wire Size (HP, AWG ratings) (for main circuit power input and inverter output)

Power supply voltage	Applicable motor rating (HP)	Inverter type	Recommended wire size (AWG) at 50°C (122°F) or below																	
			Main circuit power input [L1/R, L2/S, L3/T] or [L1/L, L2/N]						Inverter output [U, V, W]											
			w/ DC reactor (DCR)			w/o DC reactor (DCR)			w/ DC reactor (DCR)			w/o DC reactor (DCR)								
			Allowable temp.*1			Current (A)	Allowable temp.*1			Current (A)	Allowable temp.*1			Current (A)						
140°F	167°F	194°F	140°F	167°F	194°F	140°F	167°F	194°F	140°F	167°F	194°F									
Three-phase 230 V	1/8	FRN0001C2S-2□	14	14	14	0.57	14	14	14	1.1	14	14	0.8							
	1/4	FRN0002C2S-2□				0.93				1.8			1.5							
	1/2	FRN0004C2S-2□				1.6				3.1			3.0							
	1	FRN0006C2S-2□				3.0				5.3			5.5							
	2	FRN0010C2S-2□				5.7				9.5			8.0							
	3	FRN0012C2S-2□				8.3				13.2			11							
	5	FRN0020C2S-2□				14.0				22.2			17							
	7.5	FRN0025C2S-2□				10				21.1			8	12	12	31.5	10	12	25	
	10	FRN0033C2S-2□				8				28.8			6	10	10	42.7	8	12	12	33
	15	FRN0047C2S-2□				6				42.2			4	6	8	60.7	6	8	10	47
20	FRN0060C2S-2□	4	57.6	1	4	6	80.1	4	6	8	60									
Three-phase 460 V	1/2	FRN0002C2■-4□	14	14	14	0.85	14	14	14	1.7	14	14	1.5							
	1	FRN0004C2■-4□				1.6				3.1			2.5							
	2	FRN0005C2■-4□				3.0				5.9			3.7							
	3	FRN0007C2■-4□				4.4				8.2			5.5							
	5	FRN0011C2■-4□				7.3				13.0			9							
	7.5	FRN0013C2■-4□				10.6				17.3			13							
	10	FRN0018C2■-4□				14.4				23.2			12	18						
	15	FRN0024C2■-4□				10				21.1			8	12	12	33.0	10	10	24	
20	FRN0030C2■-4□	8	28.8	6	10	10	43.8	8	12	30										
Single-phase 230 V	1/8	FRN0001C2■-7□	14	14	14	1.1	14	14	14	1.8	14	14	0.8							
	1/4	FRN0002C2■-7□				2.0				3.3			1.5							
	1/2	FRN0004C2■-7□				3.5				5.4			3.0							
	1	FRN0006C2■-7□				6.4				9.7			5.0							
	2	FRN0010C2■-7□				11.7				16.4			8.0							
	3	FRN0012C2■-7□				12				17.5			10	12	24.8	11				
Single-phase 115 V	1/8	FRN0001C2S-6U	14	14	14	2.1	14	14	14	3.5	14	14	0.7							
	1/4	FRN0002C2S-6U				3.8				5.8			1.4							
	1/2	FRN0003C2S-6U				6.4				9.4			2.5							
	1	FRN0005C2S-6U				12.0				16.0			4.2							

\*1 Assuming the use of bare wiring (without rack or duct): 600 V class of vinyl-insulated IV wires for 60°C (140°F), 600 V class of polyethylene-insulated HIV wires for 75°C (167°F), and 600 V class of polyethylene-insulated cross-link wires for 90°C (194°F).

- Notes: 1) A box (□) in the above table replaces A, C, E, or U depending on shipping destination.  
 2) A box (■) in the above table replaces S (Basic type) or E (EMC filter built-in type) depending on the enclosure.  
 3) Values in parentheses ( ) in the above table denote wire sizes for the European version.



 If environmental requirements such as power supply voltage and ambient temperature differ from those listed above, select wires suitable for your system by referring to Table 6.1 and Appendices, App. F "Allowable Current of Insulated Wires."

Table 6.2 Cont. (HP, AWG ratings) (for DC reactor, braking resistor, control circuits, and inverter grounding)

Power supply voltage	Applicable motor rating (HP)	Inverter type	Recommended wire size (AWG) at 50°C (122°F) or below													
			DC reactor [P1, P(+)]				Braking resistor [P(+), DB]				Control circuit			Inverter grounding [G]		
			Allowable temp.*1			Current (A)	Allowable temp.*1			Current (A)	Allowable temp.*1			Allowable temp.*1		
			140°F	167°F	194°F		140°F	167°F	194°F		140°F	167°F	194°F	140°F	167°F	194°F
Three-phase 230 V	1/8	FRN0001C2S-2□	14	14	14	0.70	-	-	-	-	20	20	20	14	14	14
	1/4	FRN0002C2S-2□				1.1	-	-	-	-						
	1/2	FRN0004C2S-2□				2.0	-	-	-	-						
	1	FRN0006C2S-2□				3.7	-	-	-	-						
	2	FRN0010C2S-2□	7.0	-	-	-	-									
	3	FRN0012C2S-2□	10.2	-	-	-	-									
	5	FRN0020C2S-2□	12	14	14	14	4.1	-	-	-	-	-	-	-	-	-
	7.5	FRN0025C2S-2□	10	12	-	-	-	6.4	-	-	-	-	-	12	12	12
	10	FRN0033C2S-2□	6	10	12	35.3	-	-	-	-	-	-	-	10	10	10
	15	FRN0047C2S-2□	4	8	10	51.7	-	-	-	-	-	-	-	8	8	8
20	FRN0060C2S-2□	1	6	6	70.6	-	-	-	-	-	-	-	-	-	-	
Three-phase 460 V	1/2	FRN0002C2■-4□	14	14	14	1.0	-	-	-	-	20	20	20	14	14	14
	1	FRN0004C2■-4□				1.9	-	-	-	-						
	2	FRN0005C2■-4□				3.6	-	-	-	-						
	3	FRN0007C2■-4□				5.3	-	-	-	-						
	5	FRN0011C2■-4□	9.0	14	14	14	2.1	-	-	-	-	-	-	-	-	
	7.5	FRN0013C2■-4□	13.0	-	-	-	3.2	-	-	-	-	-	-	-	-	
	10	FRN0018C2■-4□	12	-	-	-	17.7	-	-	-	-	-	-	12	12	12
	15	FRN0024C2■-4□	10	12	-	-	25.9	-	-	-	-	-	-	-	-	
20	FRN0030C2■-4□	6	10	12	35.3	-	-	-	-	-	-	-	-	-		
Single-phase 230 V	1/8	FRN0001C2■-7□	14	14	14	1.1	-	-	-	-	20	20	20	14	14	14
	1/4	FRN0002C2■-7□				2.0	-	-	-	-						
	1/2	FRN0004C2■-7□				3.5	-	-	-	0.82						
	1	FRN0006C2■-7□				6.4	14	14	14	1.4						
	2	FRN0010C2■-7□	11.7	-	-	-	1.4									
3	FRN0012C2■-7□	12	-	-	-	1.7										
Single-phase 115 V	1/8	FRN0001C2S-6U	-	-	-	-	-	-	-	-	20	20	20	14	14	14
	1/4	FRN0002C2S-6U	-	-	-	-	-	-								
	1/2	FRN0003C2S-6U	-	-	-	-	0.82									
	1	FRN0005C2S-6U	-	-	-	-	1.4									

\*1 Assuming the use of bare wiring (without rack or duct): 600 V class of vinyl-insulated IV wires for 60°C (140°F), 600 V class of polyethylene-insulated HIV wires for 75°C (167°F), and 600 V class of polyethylene-insulated cross-link wires for 90°C (194°F).

- Notes: 1) A box (□) in the above table replaces A, C, E, or U depending on shipping destination.  
 2) A box (■) in the above table replaces S (Basic type) or E (EMC filter built-in type) depending on the enclosure.  
 3) Values in parentheses ( ) in the above table denote wire sizes for the European version.

 If environmental requirements such as power supply voltage and ambient temperature differ from those listed above, select wires suitable for your system by referring to Table 6.1 and Appendices, App. F "Allowable Current of Insulated Wires."

■ If the internal temperature of your power control cabinet is 40°C (104°F) or below

Table 6.3 Wire Size (kW, mm<sup>2</sup> ratings) (for main circuit power input and inverter output)

Power supply voltage	Applicable motor rating (kW)	Inverter type	Recommended wire size (mm <sup>2</sup> ) at 40°C (104°F) or below											
			Main circuit power input [L1/R, L2/S, L3/T] or [L1/L, L2/N]									Inverter output [U, V, W]		
			w/ DC reactor (DCR)			w/o DC reactor (DCR)								
			Allowable temp.*1			Current (A)	Allowable temp.*1			Current (A)	Allowable temp.*1			Current (A)
60°C	75°C	90°C		60°C	75°C	90°C		60°C	75°C	90°C				
Three-phase 200 V	0.1	FRN0001C2S-2□	2.0 (2.5)	2.0 (2.5)	2.0 (2.5)	0.57	2.0 (2.5)	2.0 (2.5)	2.0 (2.5)	1.1	2.0 (2.5)	2.0 (2.5)	2.0 (2.5)	0.8
	0.2	FRN0002C2S-2□				0.93				1.8				1.5
	0.4	FRN0004C2S-2□				1.6				3.1				3.0
	0.75	FRN0006C2S-2□				3.0				5.3				5.5
	1.5	FRN0010C2S-2□				5.7				9.5				8.0
	2.2	FRN0012C2S-2□				8.3				13.2				11
	3.7	FRN0020C2S-2□				14.0				22.2				17
	5.5	FRN0025C2S-2□				21.1				31.5				25
	7.5	FRN0033C2S-2□				28.8				42.7				33
	11	FRN0047C2S-2□				42.2				60.7				47
15	FRN0060C2S-2□	57.6	80.1	60										
Three-phase 400 V	0.4	FRN0002C2■-4□	2.0 (2.5)	2.0 (2.5)	2.0 (2.5)	0.85	2.0 (2.5)	2.0 (2.5)	2.0 (2.5)	1.7	2.0 (2.5)	2.0 (2.5)	2.0 (2.5)	1.5
	0.75	FRN0004C2■-4□				1.6				3.1				2.5
	1.5	FRN0005C2■-4□				3.0				5.9				3.7
	2.2	FRN0007C2■-4□				4.4				8.2				5.5
	3.7/4.0	FRN0011C2■-4□				7.3				13.0				9
	5.5	FRN0013C2■-4□				10.6				17.3				13
	7.5	FRN0018C2■-4□				14.4				23.2				18
	11	FRN0024C2■-4□				21.1				33.0				24
15	FRN0030C2■-4□	28.8	43.8	30										
Single-phase 200 V	0.1	FRN0001C2■-7□	2.0 (2.5)	2.0 (2.5)	2.0 (2.5)	1.1	2.0 (2.5)	2.0 (2.5)	2.0 (2.5)	1.8	2.0 (2.5)	2.0 (2.5)	2.0 (2.5)	0.8
	0.2	FRN0002C2■-7□				2.0				3.3				1.5
	0.4	FRN0004C2■-7□				3.5				5.4				3.0
	0.75	FRN0006C2■-7□				6.4				9.7				5.0
	1.5	FRN0010C2■-7□				11.7				16.4				8.0
	2.2	FRN0012C2■-7□				17.5				24.8				11
Single-phase 100 V	0.1	FRN0001C2S-6U	2.0 (2.5)	2.0 (2.5)	2.0 (2.5)	2.1	2.0 (2.5)	2.0 (2.5)	2.0 (2.5)	3.5	2.0 (2.5)	2.0 (2.5)	2.0 (2.5)	0.7
	0.2	FRN0002C2S-6U				3.8				5.8				1.4
	0.4	FRN0003C2S-6U				6.4				9.4				2.5
	0.75	FRN0005C2S-6U				12.0				16.0				4.2

\*1 Assuming the use of bare wiring (without rack or duct): 600 V class of vinyl-insulated IV wires for 60°C, 600 V class of polyethylene-insulated HIV wires for 75°C, and 600 V class of polyethylene-insulated cross-link wires for 90°C.

- Notes: 1) A box (□) in the above table replaces A, C, E, or U depending on shipping destination.  
 2) A box (■) in the above table replaces S (Basic type) or E (EMC filter built-in type) depending on the enclosure.  
 3) Values in parentheses ( ) in the above table denote wire sizes for the European version.

 If environmental requirements such as power supply voltage and ambient temperature differ from those listed above, select wires suitable for your system by referring to Table 6.1 and Appendices, App. F "Allowable Current of Insulated Wires."



Table 6.3 Cont. (kW, mm<sup>2</sup> ratings) (for DC reactor, braking resistor, control circuit, and inverter grounding)

Power supply voltage	Applicable motor rating (kW)	Inverter type	Recommended wire size (mm <sup>2</sup> ) at 40°C (104°F) or below																			
			DC reactor [P1, P(+)]				Braking resistor [P(+), DB]				Control circuit			Inverter grounding Ⓜ[G]								
			Allowable temp.*1			Current (A)	Allowable temp.*1			Current (A)	Allowable temp.*1			Allowable temp.*1								
			60°C	75°C	90°C		60°C	75°C	90°C		60°C	75°C	90°C	60°C	75°C	90°C						
Three-phase 200 V	0.1	FRN0001C2S-2□	2.0 (2.5)	2.0 (2.5)	2.0 (2.5)	0.7	-	-	-	2.0 (2.5)	2.0 (2.5)	2.0 (2.5)	0.5	0.5	0.5	2.0 (2.5)	2.0 (2.5)	2.0 (2.5)				
	0.2	FRN0002C2S-2□				1.1	-	-	-													
	0.4	FRN0004C2S-2□				2.0	-	-	-													
	0.75	FRN0006C2S-2□				3.7	-	-	-													
	1.5	FRN0010C2S-2□				7.0	-	-	-													
	2.2	FRN0012C2S-2□				10.2	-	-	-													
	3.7	FRN0020C2S-2□				17.2	-	-	-													
	5.5	FRN0025C2S-2□				3.5 (4)	2.0	2.0	2.0										6.4	3.5 (4)	3.5 (4)	3.5 (4)
	7.5	FRN0033C2S-2□				5.5 (6)	3.5 (4)	3.5 (4)	35.3										6.1	5.5 (6)	5.5 (6)	5.5 (6)
	11	FRN0047C2S-2□				14 (16)	5.5 (6)	5.5 (6)	51.7										9.1	8 (10)	8 (10)	8 (10)
15	FRN0060C2S-2□	14 (16)	14 (16)	8 (10)	70.6	11	8 (10)	8 (10)	8 (10)													
Three-phase 400 V	0.4	FRN0002C2■-4□	2.0 (2.5)	2.0 (2.5)	2.0 (2.5)	1.0	2.0 (2.5)	2.0 (2.5)	2.0 (2.5)	0.8	0.5	0.5	0.5	2.0 (2.5)	2.0 (2.5)	2.0 (2.5)						
	0.75	FRN0004C2■-4□				1.9				1.1												
	1.5	FRN0005C2■-4□				3.6				1.8												
	2.2	FRN0007C2■-4□				5.3				1.8												
	3.7/4.0	FRN0011C2■-4□				9.0				2.1												
	5.5	FRN0013C2■-4□				13.0				3.2												
	7.5	FRN0018C2■-4□				17.7				3.1												
	11	FRN0024C2■-4□				3.5 (4)				25.9							4.5	3.5 (4)	3.5 (4)	3.5 (4)		
15	FRN0030C2■-4□	5.5 (6)	3.5 (4)	3.5 (4)	35.3	5.7																
Single-phase 200 V	0.1	FRN0001C2■-7□	2.0 (2.5)	2.0 (2.5)	2.0 (2.5)	1.1	2.0 (2.5)	2.0 (2.5)	2.0 (2.5)	-	0.5	0.5	0.5	2.0 (2.5)	2.0 (2.5)	2.0 (2.5)						
	0.2	FRN0002C2■-7□				2.0				-							-	-				
	0.4	FRN0004C2■-7□				3.5				0.82												
	0.75	FRN0006C2■-7□				6.4				1.4												
	1.5	FRN0010C2■-7□				11.7				1.4												
	2.2	FRN0012C2■-7□				17.5				1.7												
Single-phase 100 V	0.1	FRN0001C2S-6U	-	-	-	-	2.0 (2.5)	2.0 (2.5)	2.0 (2.5)	-	0.5	0.5	0.5	2.0 (2.5)	2.0 (2.5)	2.0 (2.5)						
	0.2	FRN0002C2S-6U				-				-							-					
	0.4	FRN0003C2S-6U				0.82																
	0.75	FRN0005C2S-6U				1.4																

\*1 Assuming the use of bare wiring (without rack or duct): 600 V class of vinyl-insulated IV wires for 60°C, 600 V class of polyethylene-insulated HIV wires for 75°C, and 600 V class of polyethylene-insulated cross-link wires for 90°C.

- Notes: 1) A box (□) in the above table replaces A, C, E, or U depending on shipping destination.  
 2) A box (■) in the above table replaces S (Basic type) or E (EMC filter built-in type) depending on the enclosure.  
 3) Values in parentheses ( ) in the above table denote wire sizes for the European version.

 If environmental requirements such as power supply voltage and ambient temperature differ from those listed above, select wires suitable for your system by referring to Table 6.1 and Appendices, App. F "Allowable Current of Insulated Wires."

Table 6.3 Cont. Wire Size (HP, AWG ratings) (for main circuit power input and inverter output)

Power supply voltage	Applicable motor rating (HP)	Inverter type	Recommended wire size (AWG) at 40°C (104°F) or below										
			Main circuit power input [L1/R, L2/S, L3/T] or [L1/L, L2/N]						Inverter output [U, V, W]				
			w/ DC reactor (DCR)			w/o DC reactor (DCR)			w/ DC reactor (DCR)			w/o DC reactor (DCR)	
			Allowable temp.*1			Current (A)	Allowable temp.*1			Current (A)	Allowable temp.*1		
140°F	167°F	194°F		140°F	167°F	194°F		140°F	167°F	194°F			
Three-phase 230 V	1/8	FRN0001C2S-2□	14	14	14	0.57	14	14	14	1.1	14	14	0.8
	1/4	FRN0002C2S-2□				0.93				1.8			1.5
	1/2	FRN0004C2S-2□				1.6				3.1			3.0
	1	FRN0006C2S-2□				3.0				5.3			5.5
	2	FRN0010C2S-2□				5.7				9.5			8.0
	3	FRN0012C2S-2□				8.3				13.2			11
	5	FRN0020C2S-2□				14.0				22.2			17
	7.5	FRN0025C2S-2□				21.1				31.5			25
	10	FRN0033C2S-2□				28.8				42.7			33
	15	FRN0047C2S-2□				42.2				60.7			47
20	FRN0060C2S-2□	57.6	80.1	60									
Three-phase 460 V	1/2	FRN0002C2■-4□	14	14	14	0.85	14	14	14	1.7	14	14	1.5
	1	FRN0004C2■-4□				1.6				3.1			2.5
	2	FRN0005C2■-4□				3.0				5.9			3.7
	3	FRN0007C2■-4□				4.4				8.2			5.5
	5	FRN0011C2■-4□				7.3				13.0			9
	7.5	FRN0013C2■-4□				10.6				17.3			13
	10	FRN0018C2■-4□				14.4				23.2			18
	15	FRN0024C2■-4□				21.1				33.0			24
	20	FRN0030C2■-4□				28.8				43.8			30
Single-phase 230 V	1/8	FRN0001C2■-7□	14	14	14	1.1	14	14	14	1.8	14	14	0.8
	1/4	FRN0002C2■-7□				2.0				3.3			1.5
	1/2	FRN0004C2■-7□				3.5				5.4			3.0
	1	FRN0006C2■-7□				6.4				9.7			5.0
	2	FRN0010C2■-7□				11.7				16.4			8.0
	3	FRN0012C2■-7□				17.5				24.8			11
Single-phase 115 V	1/8	FRN0001C2S-6U	14	14	14	2.1	14	14	14	3.5	14	14	0.7
	1/4	FRN0002C2S-6U				3.8				5.8			1.4
	1/2	FRN0003C2S-6U				6.4				9.4			2.5
	1	FRN0005C2S-6U				12.0				16.0			4.2

\*1 Assuming the use of bare wiring (without rack or duct): 600 V class of vinyl-insulated IV wires for 60°C (140°F), 600 V class of polyethylene-insulated HIV wires for 75°C (167°F), and 600 V class of polyethylene-insulated cross-link wires for 90°C (194°F).

- Notes: 1) A box (□) in the above table replaces A, C, E, or U depending on shipping destination.  
 2) A box (■) in the above table replaces S (Basic type) or E (EMC filter built-in type) depending on the enclosure.  
 3) Values in parentheses ( ) in the above table denote wire sizes for the European version.



 If environmental requirements such as power supply voltage and ambient temperature differ from those listed above, select wires suitable for your system by referring to Table 6.1 and Appendices, App. F "Allowable Current of Insulated Wires."

Table 6.3 Cont. (HP, AWG ratings) (for DC reactor, braking resistor, control circuit, and inverter grounding)

Power supply voltage	Applicable motor rating (HP)	Inverter type	Recommended wire size (AWG) at 40°C (104°F) or below													
			DC reactor [P1, P(+)]				Braking resistor [P(+), DB]				Control circuit			Inverter grounding [G]		
			Allowable temp.*1			Current (A)	Allowable temp.*1			Current (A)	Allowable temp.*1			Allowable temp.*1		
			140°F	167°F	194°F		140°F	167°F	194°F		140°F	167°F	194°F	140°F	167°F	194°F
Three-phase 230 V	1/8	FRN0001C2S-2□	14	14	14	0.7	-	-	-	20	20	20	14	14	14	
	1/4	FRN0002C2S-2□				1.1	-	-	-							
	1/2	FRN0004C2S-2□				2.0	-	-	-							1.2
	1	FRN0006C2S-2□				3.7	-	-	-							1.6
	2	FRN0010C2S-2□				7.0	-	-	-							3.6
	3	FRN0012C2S-2□				10.2	-	-	-							3.5
	5	FRN0020C2S-2□				17.2	14	14	14							4.1
	7.5	FRN0025C2S-2□				25.9	-	-	-							6.4
	10	FRN0033C2S-2□				35.3	-	-	-							6.1
	15	FRN0047C2S-2□				51.7	-	-	-							9.1
20	FRN0060C2S-2□	70.6	6	6	8	11	8	8	8							
Three-phase 460 V	1/2	FRN0002C2■-4□	14	14	14	1.0	-	-	-	20	20	20	14	14	14	
	1	FRN0004C2■-4□				1.9	-	-	-							1.1
	2	FRN0005C2■-4□				3.6	-	-	-							1.8
	3	FRN0007C2■-4□				5.3	-	-	-							1.8
	5	FRN0011C2■-4□				9.0	14	14	14							2.1
	7.5	FRN0013C2■-4□				13.0	-	-	-							3.2
	10	FRN0018C2■-4□				17.7	-	-	-							3.1
	15	FRN0024C2■-4□				25.9	-	-	-							4.5
20	FRN0030C2■-4□	35.3	10	12	12	5.7	12	12	12							
Single-phase 230 V	1/8	FRN0001C2■-7□	14	14	14	1.1	-	-	-	20	20	20	14	14	14	
	1/4	FRN0002C2■-7□				2.0	-	-	-							
	1/2	FRN0004C2■-7□				3.5	-	-	-							0.82
	1	FRN0006C2■-7□				6.4	14	14	14							1.4
	2	FRN0010C2■-7□				11.7	-	-	-							1.4
	3	FRN0012C2■-7□				17.5	-	-	-							1.7
Single-phase 115 V	1/8	FRN0001C2S-6U	-	-	-	-	-	-	-	20	20	20	14	14	14	
	1/4	FRN0002C2S-6U	-	-	-	-	-	-								
	1/2	FRN0003C2S-6U	-	-	-	-	-	-	0.82							
	1	FRN0005C2S-6U	-	-	-	-	-	-	1.4							

\*1 Assuming the use of bare wiring (without rack or duct): 600 V class of vinyl-insulated IV wires for 60°C (140°F), 600 V class of polyethylene-insulated HIV wires for 75°C (167°F), and 600 V class of polyethylene-insulated cross-link wires for 90°C (194°F).

- Notes: 1) A box (□) in the above table replaces A, C, E, or U depending on shipping destination.  
 2) A box (■) in the above table replaces S (Basic type) or E (EMC filter built-in type) depending on the enclosure.  
 3) Values in parentheses ( ) in the above table denote wire sizes for the European version.

 If environmental requirements such as power supply voltage and ambient temperature differ from those listed above, select wires suitable for your system by referring to Table 6.1 and Appendices, App. F "Allowable Current of Insulated Wires."

---

## 6.2.2 Crimp terminals

Table 6.4 lists the recommended ring tongue crimp terminals that can be specified by the wires and screws to be used for your inverter model.

Table 6.4 Crimp Terminal Size

Wire size (mm <sup>2</sup> )	Terminal screw size	Ring tongue crimp terminal
0.5	M3.5	1.25 - 3.5
	M4	1.25 - 4
0.75	M3.5	1.25 - 3.5
	M4	1.25 - 4
1.25	M3.5	1.25 - 3.5
	M4	1.25 - 4
2.0	M3.5	2 - 3.5
	M4	2 - 4
3.5/5.5	M4	4 - 5.5

## 6.3 Peripheral Equipment

### [ 1 ] Molded case circuit breaker (MCCB), earth leakage circuit breaker (ELCB) and magnetic contactor (MC)

#### [ 1.1 ] Functional overview

##### ■ MCCBs and ELCBs\*

\*With overcurrent protection

Molded Case Circuit Breakers (MCCBs) are designed to protect the power circuits between the power supply and inverter's main circuit terminals (L1/R, L2/S and L3/T for three phase, or L1/L and L2/N for single-phase power source) from overload or short-circuit, which in turn prevents secondary accidents caused by the inverter malfunctioning.

Earth Leakage Circuit Breakers (ELCBs) function in the same way as MCCBs.

Built-in overcurrent/overload protective functions protect the inverter itself from failures related to its input/output lines.

##### ■ MCs

An MC can be used at both the power input and output sides of the inverter. At each side, the MC works as described below. When inserted in the output circuit of the inverter, the MC can also switch the motor drive power source between the inverter output and commercial power lines.

#### At the power source side

Insert an MC in the power source side of the inverter in order to:

- (1) Forcibly cut off the inverter from the power source (generally, commercial/factory power lines) with the protective function built into the inverter, or with the external signal input.
- (2) Stop the inverter operation in an emergency when the inverter cannot interpret the stop command due to internal/external circuit failures.
- (3) Cut off the inverter from the power source when the MCCB inserted in the power source side cannot cut it off for maintenance or inspection purpose. For the purpose only, it is recommended that you use an MC capable of turning the MC ON/OFF manually.

**Note** When your system requires starting/stopping the motor(s) driven by the inverter with the MC, the frequency of the starting/stopping operation should be once or less per hour. The more frequent the operation, the shorter operation life of the MC and capacitor/s used in the DC link bus due to thermal fatigue caused by the frequent charging of the current flow. It is recommended that terminal commands (FWD), (REV) and (HLD) for 3-wire operation or the keypad be used for starting/stopping the motor.

#### At the output side

Insert an MC in the power output side of the inverter in order to:

- (1) Prevent externally turned-around current from being applied to the inverter power output terminals (U, V, and W) unexpectedly. An MC should be used, for example, if a circuit that switches the motor driving power source between the inverter output and commercial power lines is connected to the inverter.

**Tip** As application of the external current to the inverter's secondary (output) circuits may break the Insulated Gate Bipolar Transistors (IGBTs), MCs should be used in the power control system circuits to switch the motor drive power source to the commercial power lines after the motor has come to a complete stop. Also ensure that voltage is never mistakenly applied to the inverter output terminals due to unexpected timer operation, or similar.

- (2) Drive more than one motor selectively by a single inverter.
- (3) Selectively cut off the motor whose thermal overload relay or equivalent devices have been activated.

## Driving the motor using commercial power lines

MCs can also be used to switch the power source of the motor driven by the inverter to a commercial power source.

Select the MC so as to satisfy the rated currents listed in Table 6.1, which are the most critical RMS currents for using the inverter. For switching the motor drive source between the inverter output and commercial power lines, use the MC of class AC3 specified by JIS C8325 in the commercial line side.

### [ 1.2 ] Connection example and criteria for selection of circuit breakers

Figure 6.2 shows a connection example for MCCB or ELCB (with overcurrent protection) in the inverter input circuit. Table 6.5 lists the rated current for the MCCB and corresponding inverter models. Table 6.6 lists the applicable grades of ELCB sensitivity.

**⚠ WARNING**

Insert an MCCB or ELCB (with overcurrent protection) recommended for each inverter for its input circuits. Do not use an MCCB or ELCB of a higher rating than that recommended.

**Doing so could result in a fire.**

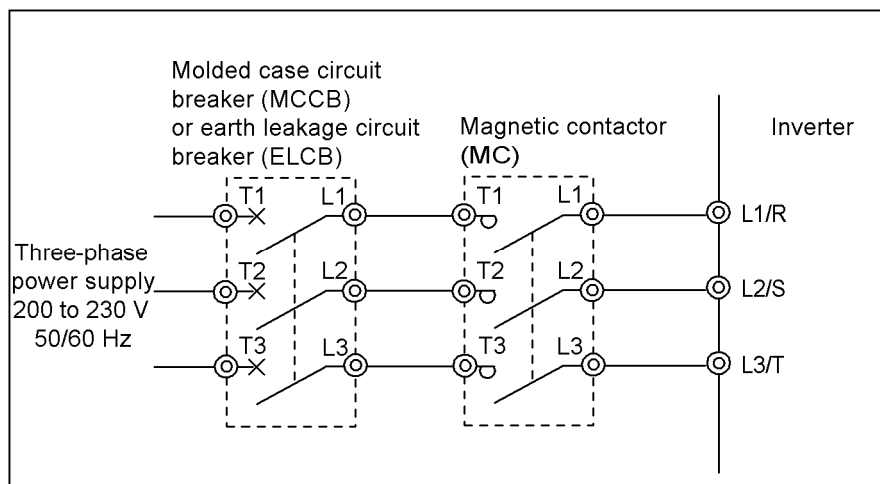
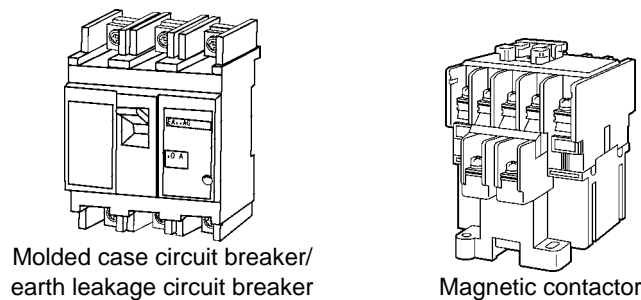

Figure 6.2 External Views of Molded Case Circuit Breaker/Earth Leakage Circuit Breaker, Magnetic Contactor and Connection Example

Table 6.5 Rated Current of Molded Case Circuit Breaker/Earth Leakage Circuit Breaker and Magnetic Contactor

Power supply voltage	Applicable motor rating (kW)	Applicable motor rating (HP)	Inverter type	MCCB, ELCB Rated current (A)		Magnetic contactor type MC1 (for input circuit)		Magnetic contactor type MC2 (for output circuit)
				DC reactor (DCR)		DC reactor (DCR)		
				w/ DCR	w/o DCR	w/ DCR	w/o DCR	
Three-phase 200 V	0.1	1/8	FRN0001C2S-2□	5 (6)	5 (6)	SC-05	SC-05	SC-05
	0.2	1/4	FRN0002C2S-2□					
	0.4	1/2	FRN0004C2S-2□					
	0.75	1	FRN0006C2S-2□	10	15 (16)	SC-4-0	SC-5-1	SC-4-0
	1.5	2	FRN0010C2S-2□					
	2.2	3	FRN0012C2S-2□					
	3.7	5	FRN0020C2S-2□	20 (25)	30 (35)	SC-5-1	SC-N1	SC-5-1
	5.5	7.5	FRN0025C2S-2□	30 (35)	50	SC-4-0	SC-5-1	SC-4-0
	7.5	10	FRN0033C2S-2□	40	75	SC-5-1	SC-N1	SC-5-1
	11	15	FRN0047C2S-2□	50	100	SC-N1	SC-N2S	SC-N1
15	20	FRN0060C2S-2□	75	125	SC-N2	SC-N3	SC-N2	
Three-phase 400 V	0.4	1/2	FRN0002C2■-4□	5 (6)	5 (6)	SC-05	SC-05	SC-05
	0.75	1	FRN0004C2■-4□					
	1.5	2	FRN0005C2■-4□					
	2.2	3	FRN0007C2■-4□	10	15 (16)	SC-4-0	SC-N1	SC-4-0
	3.7/4.0	5	FRN0011C2■-4□					
	5.5	7.5	FRN0013C2■-4□					
	7.5	10	FRN0018C2■-4□	20 (25)	40	SC-4-0	SC-N1	SC-4-0
	11	15	FRN0024C2■-4□	30 (35)	50	SC-4-0	SC-N1	SC-4-0
15	20	FRN0030C2■-4□	40	60	SC-5-1	SC-N1	SC-5-1	
Single-phase 200 V	0.1	1/8	FRN0001C2■-7□	5 (6)	5 (6)	SC-05	SC-05	SC-05
	0.2	1/4	FRN0002C2■-7□					
	0.4	1/2	FRN0004C2■-7□					
	0.75	1	FRN0006C2■-7□	10	15 (16)	SC-5-1	SC-5-1	
	1.5	2	FRN0010C2■-7□					
	2.2	3	FRN0012C2■-7□					
Single-phase 100 V	0.1	1/8	FRN0001C2S-6U	5 (6)	5 (6)	SC-05	SC-05	SC-05
	0.2	1/4	FRN0002C2S-6U					
	0.4	1/2	FRN0003C2S-6U	10	15 (16)			
	0.75	1	FRN0005C2S-6U	15 (16)	20 (25)			

- The above table lists the rated current of MCCBs and ELCBs to be used in the power control cabinet with an internal temperature of lower than 50°C (122°F). The rated current is factored by a correction coefficient of 0.85 as the MCCBs' and ELCBs' original rated current is specified when using them in an ambient temperature of 40°C (104°F) or lower. Select an MCCB and/or ELCB suitable for the actual short-circuit breaking capacity needed for your power systems.
- For the selection of the MC type, it is assumed that the **600V HIV (allowable ambient temperature: 75°C (167°F))** wires for the power input/output of the inverter are used. If an MC type for another class of wires is selected, the wire size suitable for the terminal size of both the inverter and the MC type should be taken into account.
- Use ELCBs with overcurrent protection.
- To protect your power systems from secondary accidents caused by the broken inverter, use an MCCB and/or ELCB with the rated current listed in the above table. Do not use an MCCB or ELCB with a rating higher than that listed.

Notes: 1) A box (□) in the above table replaces A, C, E, or U depending on shipping destination.  
 2) A box (■) in the above table replaces S (Basic type) or E (EMC filter built-in type) depending on the enclosure.  
 3) Values in parentheses ( ) in the above table denote rated currents for the European version.

Table 6.6 lists the relationship between the rated leakage current sensitivity of ELCBs (with overcurrent protection) and wiring length of the inverter output circuits. Note that the sensitivity levels listed in the table are estimated values based on the results obtained by the test setup in the Fuji laboratory where each inverter drives a single motor.

Table 6.6 Rated Current Sensitivity of Earth Leakage Circuit Breakers (ELCBs)

Power supply voltage	Applicable motor rating (kW)	Applicable motor rating (HP)	Wiring length and current sensitivity					
			10 m	30 m	50 m	100 m	200 m	300 m
Three-phase 200V	0.1	1/8						
	0.2	1/4						
	0.4	1/2						
	0.75	1						
	1.5	2		30 mA		100 mA		200 mA
	2.2	3						
	3.7	5						
	5.5	7.5						
	7.5	10						
	11	15						
15	20							
Three-phase 400V	0.4	1/2						
	0.75	1						
	1.5	2						
	2.2	3	30 mA		100 mA		200 mA	500 mA
	3.7, 4.0	5						
	5.5	7.5						
	7.5	10						
	11	15						
15	20							
Single-phase 200V	0.1	1/8						
	0.2	1/4						
	0.4	1/2		30 mA		100 mA		200 mA
	0.75	1						
	1.5	2						
	2.2	3						
Single-phase 100V	0.1	1/8						
	0.2	1/4						
	0.4	1/2		30 mA		100 mA		200 mA
	0.75	1						

- Values listed above were obtained using Fuji ELCB EG or SG series applied to the test setup.
- The rated current of applicable motor rating indicates values for Fuji standard motor (4 poles, 50 Hz and 200 V 3-phase).
- The leakage current is calculated based on grounding of the single wire for 200V  $\Delta$  type and the neutral wire for 400V Y type power lines.
- Values listed above are calculated based on the static capacitance to the earth when the 600V class of vinyl-insulated IV wires are used in a metal conduit laid directly on the earth.
- Wiring length is the total length of wiring between the inverter and motor. If more than one motor is to be connected to a single inverter, the wiring length should be the total length of wiring between the inverter and motors.



## [ 2 ] Surge killers

A surge killer eliminates surge currents induced by lightning and noise from the power supply lines. Use of a surge killer is effective in preventing the electronic equipment, including inverters, from damage or malfunctioning caused by such surges and/or noise.

The applicable model of surge killer is the FSL-323. Figure 6.3 shows its external dimensions and a connection example. Refer to the catalog "Fuji Noise Suppressors (SH310: Japanese edition only)" for details. These products are available from Fuji Electric Technica Co., Ltd.

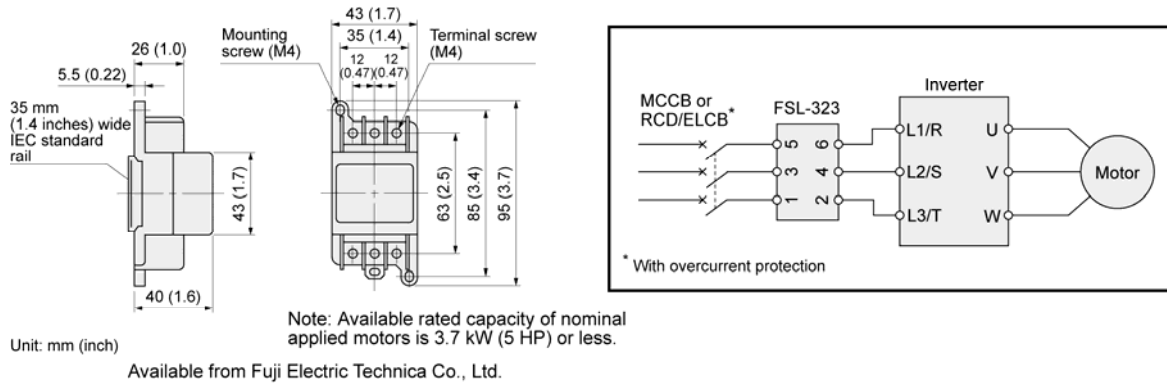

Figure 6.3 Dimensions of Surge Killer and Connection Example

### [ 3 ] Arresters

An arrester suppresses surge currents induced by lightning invaded from the power supply lines. Common use of the grounding wire that is used for electric equipment in the panel, with the arrester, is effective in preventing electronic equipment from damage or malfunctioning caused by such surges.

Applicable arrester models are CN5132 for three-phase 200V class series, and CN5134 for three-phase 400V class series. (The CN523 series with 20 kA of discharging capability is also available.)

Figure 6.4 shows their external dimensions and connection examples. Refer to the catalog "Fuji Surge Killers/Absorbers (HS165a: Japanese version only)" for details. These products are available from Fuji Electric Technica Co., Ltd.



● Three-phase (240/440 VAC)

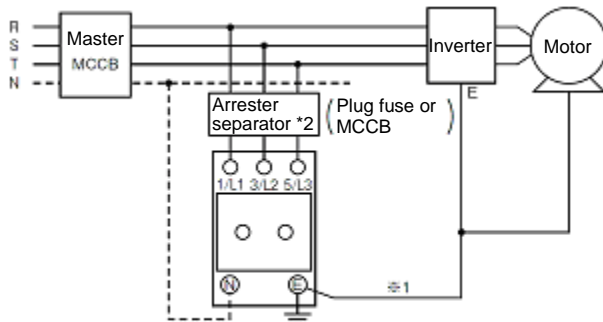

- \*1 Keep the wiring length as short as possible.
- \*2 The models with a built-in arrester separator (CN5212-FK and CN5232-FK) are not required when the short-circuit current of the circuit is 250 VAC, 10 kA or less.

(N-phase terminal is only for CN5234 and CN5234-K.)

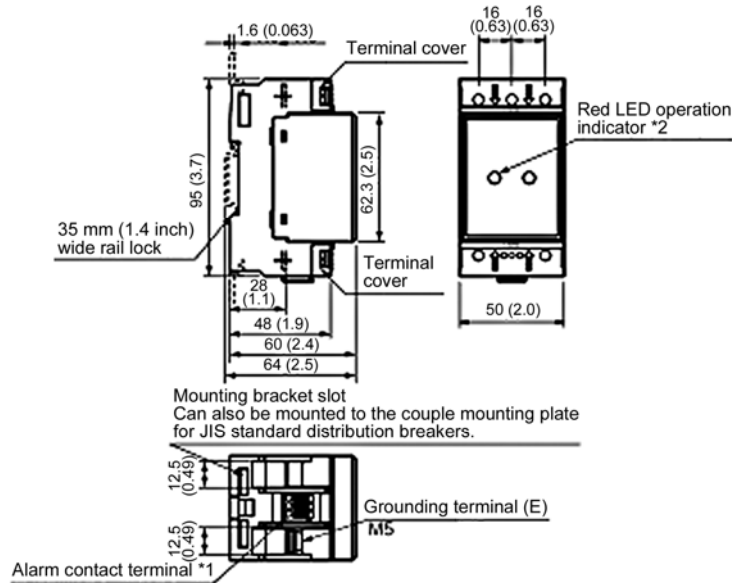

Unit: mm (inch)

- \*1 Available only on the CN5□-K series.
- \*2 Two-pole models have only the left indicator.

Available from Fuji Electric Technica Co., Ltd.

Figure 6.4 Arrester Dimensions and Connection Examples

## [ 4 ] Surge absorbers

A surge absorber suppresses surge currents and noise from the power lines to ensure effective protection of your power system from the malfunctioning of the magnetic contactors, mini-control relays and timers.

Applicable surge absorber models are the S2-A-O and S1-B-O. Figure 6.5 shows their external dimensions. Refer to the catalog "Fuji Noise Suppressors (SH310: Japanese edition only)" for details. The surge absorbers are available from Fuji Electric Technica Co., Ltd.

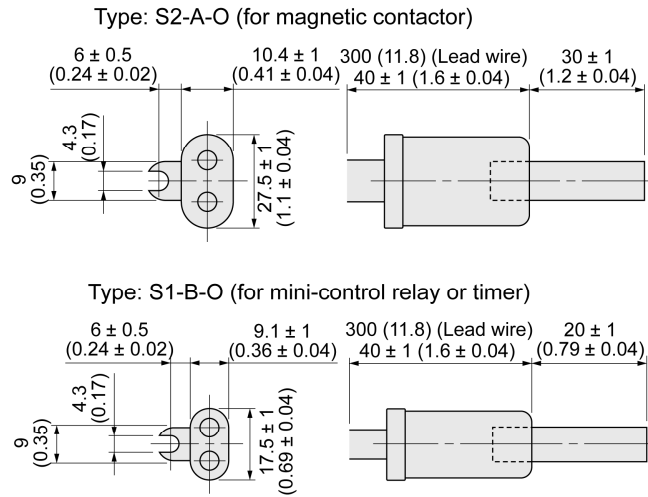

Unit: mm (inch)

Available from Fuji Electric Technica Co., Ltd.

Figure 6.5 Surge Absorber Dimensions

# 6.4 Selecting Options

## 6.4.1 Peripheral equipment options

### [ 1 ] Braking resistors

A braking resistor converts regenerative energy generated from deceleration of the motor and converts it to heat for consumption. Use of a braking resistor results in improved deceleration performance of the inverter.

 Refer to Chapter 7, Section 7.2 "Selecting a Braking Resistor."

### [ 1.1 ] Standard model

The standard model of a braking resistor integrates a facility that detects the temperature on the heat sink of the resistor and outputs a digital ON/OFF signal if the temperature exceeds the specified level (as an overheating warning signal). To ensure that the signal is recognized at one of the digital input terminals of the FRENIC-Mini, assign the external alarm (THR) to any of terminals [X1] to [X3], [FWD] and [REV]. Connect the assigned terminal to terminal [1] of the braking resistor. Upon detection of the warning signal (preset detection level: 150°C (302°F)), the inverter simultaneously transfers to Alarm mode, displays alarm  $\overline{H-L}$  on the LED monitor and shuts down its power output.

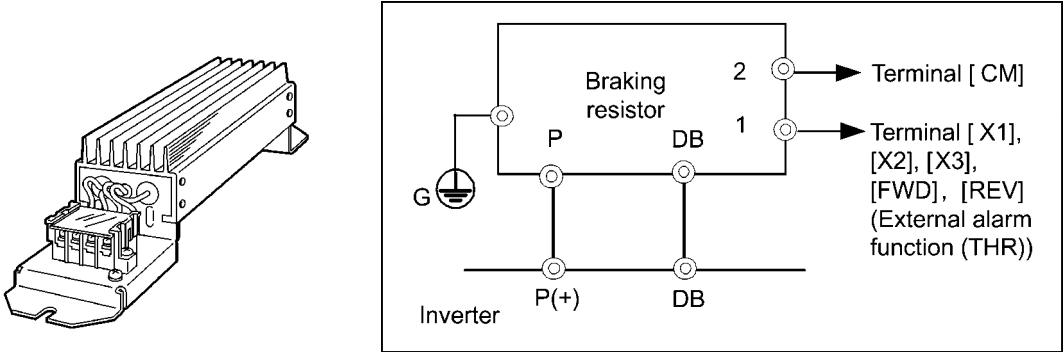

Figure 6.6 Braking Resistor (Standard Model) and Connection Example

Table 6.7 Braking Resistor (Standard Model)

Power supply voltage	Inverter type	Option			Max. braking torque (%)		Continuous braking (100% torque conversion value)		Repetitive braking (100 sec or less cycle)			
		Braking resistor			50 Hz	60 Hz	Discharging capability (kW)	Braking time (s)	Average loss (kW)	Duty cycle (%ED)		
		Type	Q'ty	Resistance (Ω)	(N·m)	(N·m)						
Three-phase 200 V	FRN0004C2S-2□	DB0.75-2	1	100	150	4.02	3.32	9	45	0.044	22	
	FRN0006C2S-2□					7.57	6.25	17		0.068	18	
	FRN0010C2S-2□	DB2.2-2	1	40		15.0	12.4	34		0.075	10	
	FRN0012C2S-2□					22.0	18.2	33	30	0.077	7	
	FRN0020C2S-2□	DB3.7-2	1	33		37.1	30.5	37	20	0.093	5	
	FRN0025C2S-2□	DB5.5-2	1	20		55.1	45.4	55		0.138		
	FRN0033C2S-2□	DB7.5-2	1	15		75.1	61.9	37	10	0.188		
	FRN0047C2S-2□	DB11-2	1	10		110.2	90.8	55		0.275		
FRN0060C2S-2□	DB15-2	1	8.6	150.3	123.8	75	0.375					
Three-phase 400 V	FRN0002C2■-4□	DB0.75-4	1	200	150	4.02	3.32	9	45	0.044		22
	FRN0004C2■-4□					7.57	6.25	17		0.068		18
	FRN0005C2■-4□	DB2.2-4	1	160		15.0	12.4	34		0.075		10
	FRN0007C2■-4□					22.0	18.2	33	30	0.077	7	
	FRN0011C2■-4□	DB3.7-4	1	130		37.1	30.5	37	20	0.093	5	
	FRN0013C2■-4□	DB5.5-4	1	80		55.1	45.4	55		0.138		
	FRN0018C2■-4□	DB7.5-4	1	60		75.1	61.9	38	10	0.188		
	FRN0024C2■-4□	DB11-4	1	40		110.2	90.8	55		0.275		
FRN0030C2■-4□	DB15-4	1	34.4	150.3	123.8	75	0.375					
Single-phase 200 V	FRN0004C2■-7□	DB0.75-2	1	100	150	4.02	3.32	9	45	0.044		22
	FRN0006C2■-7□					7.57	6.25	17		0.068		18
	FRN0010C2■-7□	DB2.2-2	1	40		15.0	12.4	34		0.075		10
	FRN0012C2■-7□					22.0	18.2	33	30	0.077	7	
Single-phase 100 V	FRN0003C2S-6U	DB0.75-2	1	100	150	4.02	3.32	9	45	0.044	22	
	FRN0005C2S-6U					7.57	6.25	17		0.068	18	

Note: 1) A box (□) in the above table replaces A, C, E, or U depending on shipping destination.

2) A box (■) in the above table replaces S (Basic type) or E (EMC filter built-in type) depending on the enclosure.

## [ 1.2 ] 10%ED model

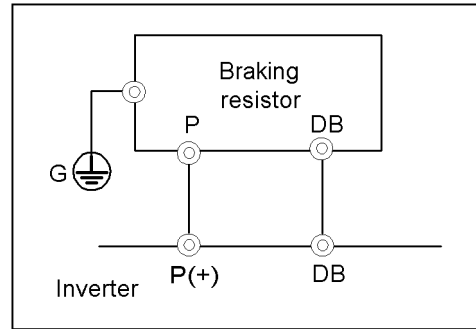
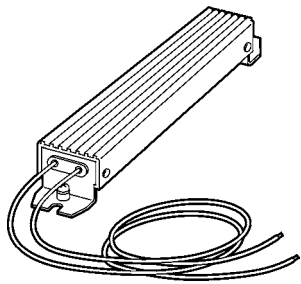

Figure 6.7 Braking Resistor (10 %ED Model) and Connection Example

Table 6.8 Braking Resistor (10 %ED Model)

Power supply voltage	Inverter type	Option			Max. braking torque (%)		Continuous braking (100% torque conversion value)		Repetitive braking (100 sec or less cycle)		
		Braking resistor			50 Hz	60 Hz	Discharging capability (kW)	Braking time (s)	Average loss (kW)	Duty cycle (%ED)	
		Type	Q'ty	Resistance (Ω)	(N·m)	(N·m)					
Three-phase 200 V	FRN0004C2S-2□	DB0.75-2C	1	100	150	4.02	3.32	50	250	0.075	37
	FRN0006C2S-2□					7.57	6.25		133		20
	FRN0010C2S-2□	DB2.2-2C	1	40		15.0	12.4	55	73	0.110	14
	FRN0012C2S-2□					22.0	18.2		50		
	FRN0020C2S-2□	DB3.7-2C	1	33		37.1	30.5	140	75	0.185	10
	FRN0025C2S-2□	DB5.5-2C	1	20		55.1	45.4	55	20	0.275	
	FRN0033C2S-2□	DB7.5-2C	1	15		75.1	61.9	37	10	0.375	
	FRN0047C2S-2□	DB11-2C	1	10		110.2	90.8	55		0.55	
FRN0060C2S-2□	DB15-2C	1	8.6	150.3	123.8	75	0.75				
Three-phase 400 V	FRN0002C2■-4□	DB0.75-4C	1	200	150	4.02	3.32	50	250	0.075	
	FRN0004C2■-4□					7.57	6.25		133		20
	FRN0005C2■-4□	DB2.2-4C	1	160		15.0	12.4	55	73	0.110	14
	FRN0007C2■-4□					22.0	18.2		50		
	FRN0011C2■-4□	DB3.7-4C	1	130		37.1	30.5	140	75	0.185	10
	FRN0013C2■-4□	DB5.5-4C	1	80		55.1	45.4	55	20	0.275	
	FRN0018C2■-4□	DB7.5-4C	1	60		75.1	61.9	38	10	0.375	
	FRN0024C2■-4□	DB11-4C	1	40		110.2	90.8	55		0.55	
FRN0030C2■-4□	DB15-4C	1	34.4	150.3	123.8	75	0.75				
Single-phase 200 V	FRN0004C2■-7□	DB0.75-2C	1	100	150	4.02	3.32	50	250	0.075	
	FRN0006C2■-7□					7.57	6.25		133		20
	FRN0010C2■-7□	DB2.2-2C	1	40		15.0	12.4	55	73	0.110	14
	FRN0012C2■-7□					22.0	18.2		50		10
Single-phase 100 V	FRN0003C2S-6U	DB0.75-2C	1	100	150	4.02	3.32	50	250	0.075	37
	FRN0005C2S-6U					7.57	6.25		133		20

Note: 1) A box (□) in the above table replaces A, C, E, or U depending on shipping destination.

2) A box (■) in the above table replaces S (Basic type) or E (EMC filter built-in type) depending on the enclosure.

The 10 %ED braking resistor does not support overheating detection or warning output, so an electronic thermal overload relay needs to be set up using function codes F50 and F51 to protect the braking resistor from overheating.

[ 1.3 ] Compact model

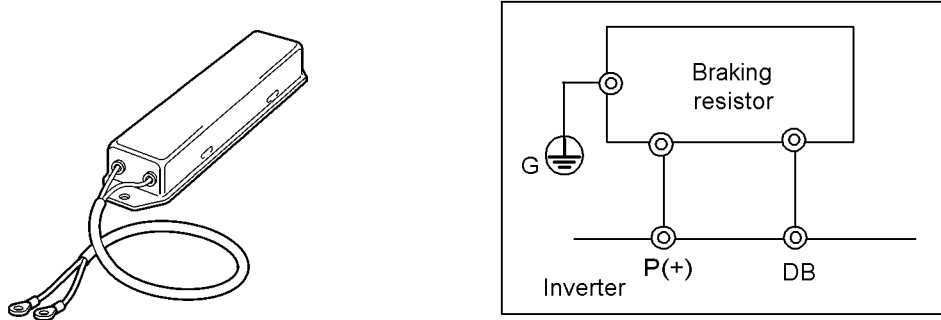

Figure 6.8 Braking Resistor (Compact Model) and Connection Example

Table 6.9 Braking Resistor (Compact Model)

Power supply voltage	Item		Model: TK80W120Ω				
200 V class	Resistor	Capacity (kW)	0.08				
		Resistance (Ω)	120				
	Applicable inverter model		FRN0004 C2■-2□	FRN0006 C2■-2□	FRN0010 C2■-2□	FRN0012 C2■-2□	FRN0020 C2■-2□
	Applicable motor output (kW)		0.4	0.75	1.5	2.2	3.7, 4.0
	Average braking torque (%)		150	150	150	100	100
	Allowable braking properties	Allowable duty cycle (%)	15	5	5	5	5
		Allowable continuous braking time	15 sec	15 sec	10 sec	10 sec	10 sec
	Braking unit		Not required				

Note: 1) A box (□) in the above table replaces A, C, E, or U depending on shipping destination.

2) A box (■) in the above table replaces S (Basic type) or E (EMC filter built-in type) depending on the enclosure.

**Note** This type of braking resistors is not applicable to the 400 V class series of inverters or to inverters of 5.5 kW (7.5 HP) or above.

## [ 2 ] DC reactors (DCRs)

A DCR is mainly used for power supply normalization and for supplied power factor improvement (for reducing harmonic components).

### ■ For power supply normalization

- Use a DCR when the capacity of a power supply transformer exceeds 500 kVA and is 10 times or more the rated inverter capacity. In this case, the percentage-reactance of the power source decreases, and harmonic components and their peak levels increase. These factors may break rectifiers or capacitors in the converter section of inverter, or decrease the capacitance of the capacitor (which can shorten the inverter's service life).
- Also use a DCR when there are thyristor-driven loads or when phase-advancing capacitors are being turned ON/OFF.
- Use a DCR when the interphase voltage unbalance ratio of the inverter power source exceeds 2%.

$$\text{Interphase voltage unbalance(\%)} = \frac{\text{Max. voltage (V)} - \text{Min. voltage (V)}}{\text{Three - phase average voltage (V)}} \times 67$$

### ■ For supplied power factor improvement (for suppressing harmonics)

Generally a capacitor is used to improve the power factor of the load, however, it cannot be used in a system that includes an inverter. Using a DCR increases the reactance of inverter's power source so as to decrease harmonic components on the power source lines and improve the power factor of inverter. Using a DCR improves the input power factor to approximately 95%.



- At the time of shipping, a short bar is connected across terminals P1 and P (+) on the terminal block. Remove the jumper bar when connecting a DCR.
- If a DCR is not going to be used, do not remove the jumper bar.

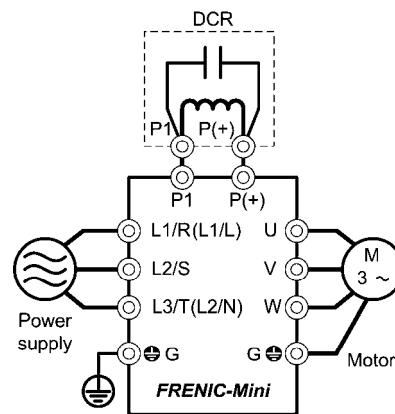
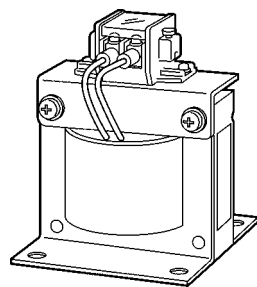

For three-phase 200 V/400 V or single-phase 200 V

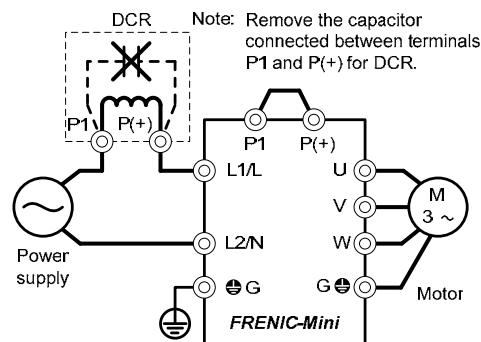

For single-phase 100V

Figure 6.9 External View of a DC Reactor (DCR) and Connection Example



Table 6.10 DC Reactors (DCRs)

Power supply voltage	Applicable motor rating (kW)	Applicable motor rating (HP)	Inverter type	DC reactor (DCR)				
				Type	Rated current (A)	Inductance (mH)	Coil resistance (mΩ)	Generated loss (W)
Three-phase 200 V	0.1	1/8	FRN0001C2S-2□	DCR2-0.2	1.5	20	660	0.8
	0.2	1/4	FRN0002C2S-2□					1.6
	0.4	1/2	FRN0004C2S-2□	DCR2-0.4	3.0	12	280	1.9
	0.75	1	FRN0006C2S-2□	DCR2-0.75	5.0	7.0	123	2.8
	1.5	2	FRN0010C2S-2□	DCR2-1.5	8.0	4.0	57.5	4.6
	2.2	3	FRN0012C2S-2□	DCR2-2.2	11	3.0	43	6.7
	3.7	5	FRN0020C2S-2□	DCR2-3.7	18	1.7	21	8.8
	5.5	7.5	FRN0025C2S-2□	DCR2-5.5	25	1.2	16	14
	7.5	10	FRN0033C2S-2□	DCR2-7.5	34	0.8	9.7	16
	11	15	FRN0047C2S-2□	DCR2-11	50	0.6	7.0	27
15	20	FRN0060C2S-2□	DCR2-15	67	0.4	4.3	27	
Three-phase 400 V	0.4	1/2	FRN0002C2■-4□	DCR4-0.4	1.5	50	970	2.0
	0.75	1	FRN0004C2■-4□	DCR4-0.75	2.5	30	440	2.5
	1.5	2	FRN0005C2■-4□	DCR4-1.5	4.0	16	235	4.8
	2.2	3	FRN0007C2■-4□	DCR4-2.2	5.5	12	172	6.8
	3.7/4.0	5	FRN0011C2■-4□	DCR4-3.7	9.0	7.0	74.5	8.1
	5.5	7.5	FRN0013C2■-4□	DCR4-5.5	13	4.0	43	10
	7.5	10	FRN0018C2■-4□	DCR4-7.5	18	3.5	35.5	15
	11	15	FRN0024C2■-4□	DCR4-11	25	2.2	23.2	21
15	20	FRN0030C2■-4□	DCR4-15	34	1.8	18.1	28	
Single-phase 200 V	0.1	1/8	FRN0001C2■-7□	DCR2-0.2	1.5	20	660	1.6
	0.2	1/4	FRN0002C2■-7□	DCR2-0.4	3.0	12	280	1.9
	0.4	1/2	FRN0004C2■-7□	DCR2-0.75	5.0	7.0	123	2.8
	0.75	1	FRN0006C2■-7□	DCR2-1.5	8.0	4.0	57.5	4.6
	1.5	2	FRN0010C2■-7□	DCR2-3.7	18	1.7	21	8.8
	2.2	3	FRN0012C2■-7□					
Single-phase 100 V	0.1	1/8	FRN0001C2S-6U	DCR2-0.75	5.0	7.0	123	2.8
	0.2	1/4	FRN0002C2S-6U	DCR2-1.5	8.0	4.0	57.5	4.6
	0.4	1/2	FRN0003C2S-6U	DCR2-2.2	11	3.0	43	6.7
	0.75	1	FRN0005C2S-6U	DCR2-3.7	18	1.7	21	8.8

Note 1: Generated losses listed in the above table are approximate values that are calculated according to the following conditions:

- The power source is 3-phase 200 V/400 V 50 Hz with 0% interphase voltage unbalance ratio.
- The power source capacity uses the larger of either 500 kVA or 10 times the rated capacity of the inverter.
- The motor is a 4-pole standard model at full load (100%).
- An AC reactor (ACR) is not connected.

Note 2: A box (□) in the above table replaces A, C, E, or U depending on shipping destination.

Note 3: A box (■) in the above table replaces S (Basic type) or E (EMC filter built-in type) depending on the enclosure.

### [ 3 ] AC reactors (ACRs)

Use an ACR when the converter part of the inverter should supply very stable DC power, for example, in DC link bus operation (shared PN operation). Generally, ACRs are used for correction of voltage waveform and power factor or for power supply normalization, but not for suppressing harmonic components in the power lines. For suppressing harmonic components, use a DCR.

An ACR should be also used when the power source is extremely unstable; for example, when the power source involves an extremely large interphase voltage unbalance.

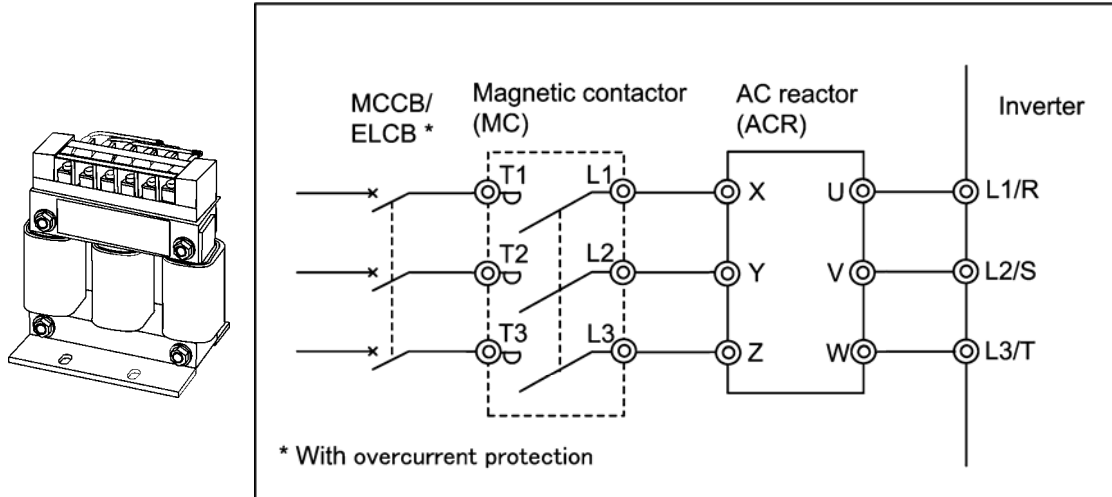

Figure 6.10 External View of AC Reactor (ACR) and Connection Example

Table 6.11 AC Reactor (ACR)

Power supply voltage	Applicable motor rating (kW)	Applicable motor rating (HP)	Inverter type	AC reactor (ACR)				
				Type	Rated current (A)	Reactance (mΩ/phase)		Generated loss (W)
						50 Hz	60 Hz	
Three-phase 200 V	0.1	1/8	FRN0001C2S-2□	ACR2-0.4A	3	917	1100	2.5
	0.2	1/4	FRN0002C2S-2□					5
	0.4	1/2	FRN0004C2S-2□					10
	0.75	1	FRN0006C2S-2□	ACR2-0.75A	5	493	592	12
	1.5	2	FRN0010C2S-2□	ACR2-1.5A	8	295	354	14
	2.2	3	FRN0012C2S-2□	ACR2-2.2A	11	213	256	16
	3.7	5	FRN0020C2S-2□	ACR2-3.7A	17	128	153	23
	5.5	7.5	FRN0025C2S-2□	ACR2-5.5A	25	87.7	105	27
	7.5	10	FRN0033C2S-2□	ACR2-7.5A	33	65	78	30
	11	15	FRN0047C2S-2□	ACR2-11A	46	45.5	54.7	37
15	20	FRN0060C2S-2□	ACR2-15A	59	34.8	41.8	43	
Three-phase 400 V	0.4	1/2	FRN0002C2■-4□	ACR4-0.75A	2.5	1920	2300	5
	0.75	1	FRN0004C2■-4□					10
	1.5	2	FRN0005C2■-4□	ACR4-1.5A	3.7	1160	1390	11
	2.2	3	FRN0007C2■-4□	ACR4-2.2A	5.5	851	1020	14
	3.7/4.0	5	FRN0011C2■-4□	ACR4-3.7A	9	512	615	17
	5.5	7.5	FRN0013C2■-4□	ACR4-5.5A	13	349	418	22
	7.5	10	FRN0018C2■-4□	ACR4-7.5A	18	256	307	27
	11	15	FRN0024C2■-4□	ACR4-11A	24	183	219	40
15	20	FRN0030C2■-4□	ACR4-15A	30	139	167	46	
Single-phase 200 V	0.1	1/8	FRN0001C2■-7□	ACR2-0.4A	3	917	1100	5
	0.2	1/4	FRN0002C2■-7□					10
	0.4	1/2	FRN0004C2■-7□	ACR2-0.75A	5	493	592	12
	0.75	1	FRN0006C2■-7□	ACR2-1.5A	8	295	354	14
	1.5	2	FRN0010C2■-7□	ACR2-2.2A	11	213	256	16
	2.2	3	FRN0012C2■-7□	ACR2-3.7A	17	128	153	23
Single-phase 100 V	0.1	1/8	FRN0001C2S-6U	ACR2-0.4A	3	917	1100	2.5
	0.2	1/4	FRN0002C2S-6U	ACR2-0.75A	5	493	592	12
	0.4	1/2	FRN0003C2S-6U	ACR2-1.5A	8	295	354	14
	0.75	1	FRN0005C2S-6U	ACR2-3.7A	17	128	153	23

Note 1: Generated losses listed in the above table are approximate values that are calculated according to the following conditions:

- The power source is 3-phase 200 V/400 V 50 Hz with 0% interphase voltage unbalance ratio.
- The power source capacity uses the larger of either 500 kVA or 10 times the rated capacity of the inverter.
- The motor is a 4-pole standard model at full load (100%).

Note 2: A box (□) in the above table replaces A, C, E, or U depending on shipping destination.

Note 3: A box (■) in the above table replaces S (Basic type) or E (EMC filter built-in type) depending on the enclosure.

## [ 4 ] Output circuit filters (OFLs)

Insert an OFL in the inverter power output circuit to:

- Suppress the voltage fluctuation at the motor power terminals  
This protects the motor from insulation damage caused by the application of high voltage surge currents from the 400 V class of inverters.
- Suppress leakage current (due to higher harmonic components) from the inverter output lines  
This reduces the leakage current when the motor is connected by long power feed lines. Keep the length of the power feed line less than 400 m (1300 ft).
- Minimize radiation and/or induction noise issued from the inverter output lines  
OFLs are effective noise suppression device for long wiring applications such as that used at plants.

**Note** Filter models OFL-\*\*\*-2 and OFL-\*\*\*-4 have restrictions on the carrier frequency. For the use of those filter models, be sure to set the carrier frequency (F26) within the allowable carrier frequency range given in Table 6.12. (Running the inverter with the carrier frequency lower than the allowable range overheats the filter.) In addition, to prevent the carrier frequency from lowering than the allowable range, be sure to disable the automatic lowering of carrier frequency by setting Bit 0 of function code H98 (Protective/Maintenance Function) to "0."

**A failure could occur.**

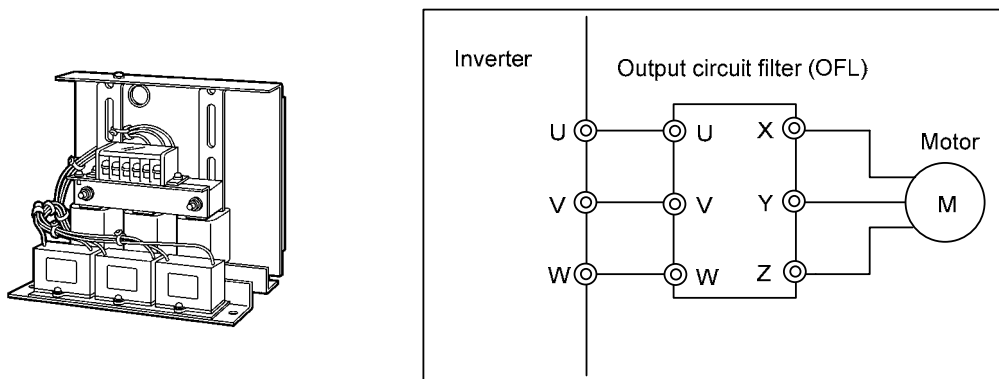

Figure 6.11 External View of Output Circuit Filter (OFL) and Connection Example

Table 6.12 Output Circuit Filter (OFL)

Power supply voltage	Applicable motor rating (kW)	Applicable motor rating (HP)	Inverter type	Filter model	Rated current (A)	Overload capability	Inverter power input voltage	Allowable carrier frequency range (kHz)	Maximum frequency (Hz)
Three-phase 200 V	0.1	1/8	FRN0001C2S-2□	OFL-0.4-2	3	150 % for 1 min. 200 % for 0.5 sec	Three-phase 200 to 230 V 50/60 Hz	8 to 16 H98 bit 0 = 0	400
	0.2	1/4	FRN0002C2S-2□						
	0.4	1/2	FRN0004C2S-2□						
	0.75	1	FRN0006C2S-2□	OFL-1.5-2	8				
	1.5	2	FRN0010C2S-2□	OFL-3.7-2	17				
	2.2	3	FRN0012C2S-2□						
	3.7	5	FRN0020C2S-2□						
	5.5	7.5	FRN0025C2S-2□	OFL-7.5-2	33				
	7.5	10	FRN0033C2S-2□	OFL-15-2	59				
	11	15	FRN0047C2S-2□						
15	20	FRN0060C2S-2□							
Three-phase 400 V	0.4	1/2	FRN0002C2■-4□	OFL-0.4-4	1.5	150% for 1min. 200 % for 0.5 sec	Three-phase 380 to 460 V 50/60 Hz	8 to 16 H98 bit 0 = 0	400
	0.75	1	FRN0004C2■-4□	OFL-1.5-4	3.7				
	1.5	2	FRN0005C2■-4□	OFL-3.7-4	9				
	2.2	3	FRN0007C2■-4□						
	3.7/4.0	5	FRN0011C2■-4□	OFL-7.5-4	18				
	5.5	7.5	FRN0013C2■-4□	OFL-15-4	30				
	7.5	10	FRN0018C2■-4□						
	11	15	FRN0024C2■-4□						
15	20	FRN0030C2■-4□							
Three-phase 400 V	0.4	1/2	FRN0002C2■-4□	OFL-0.4-4A	1.5	150% for 1min. 200 % for 0.5 sec	Three-phase 380 to 480 V 50/60 Hz	0.75 to 16	400
	0.75	1	FRN0004C2■-4□	OFL-1.5-4A	3.7				
	1.5	2	FRN0005C2■-4□	OFL-3.7-4A	9				
	2.2	3	FRN0007C2■-4□						
	3.7/4.0	5	FRN0011C2■-4□	OFL-7.5-4A	18				
	5.5	7.5	FRN0013C2■-4□	OFL-15-4A	30				
	7.5	10	FRN0018C2■-4□						
	11	15	FRN0024C2■-4□						
15	20	FRN0030C2■-4□							
Single-phase 200 V	0.1	1/8	FRN0001C2■-7□	OFL-0.4-2	3	150 % for 1 min. 200 % for 0.5 sec	Three-phase 200 to 230 V 50/60 Hz	8 to 16 H98 bit 0 = 0	400
	0.2	1/4	FRN0002C2■-7□						
	0.4	1/2	FRN0004C2■-7□						
	0.75	1	FRN0006C2■-7□	OFL-1.5-2	8				
	1.5	2	FRN0010C2■-7□	OFL-3.7-2	17				
	2.2	3	FRN0012C2■-7□						

Note 1: The OFL-\*\*\*-4A models have no restrictions on carrier frequency.

Note 2: A box (□) in the above table replaces A, C, E, or U depending on shipping destination.

Note 3: A box (■) in the above table replaces S (Basic type) or E (EMC filter built-in type) depending on the enclosure.

## [ 5 ] Surge suppression unit (SSU)



If the drive wire for the motor is long, an extremely low surge voltage (micro surge) occurs at the wire end connected to the motor. Surge voltage causes motor degradation, insulation breakdown, or increased noises. The surge suppression unit (SSU) suppresses the surge voltage. It features the connectivity for all motor capacities and easy wiring work.

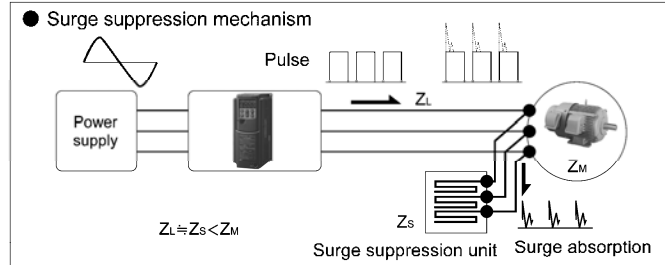

### ■ Dimensions

● 50 m (164 ft) spec.: SSU 50TA-NS

● 100 m (328 ft) spec.: SSU 100TA-NS

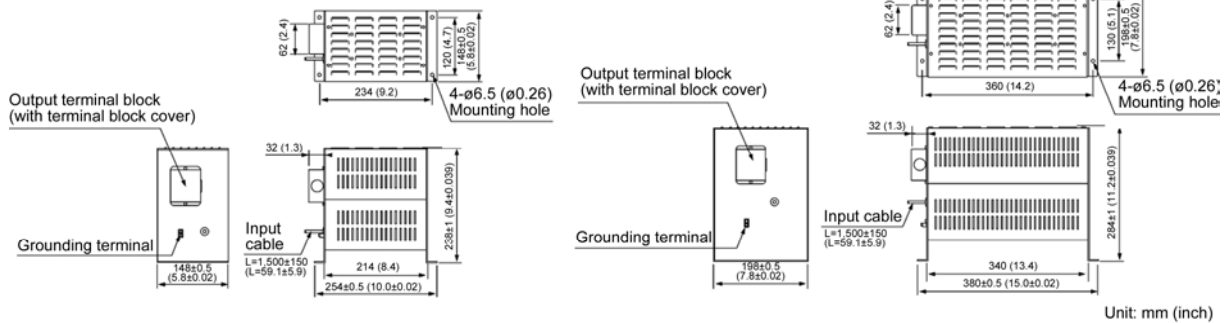

### ■ Effects of installing the surge suppression units (shown by voltage waveform between motors)

Motor/inverter capacity: 3.7 kW (5 HP)  
Running status: No-load  
Wiring length: 50 m (164 ft)  
Power supply voltage: Three-phase 400 V

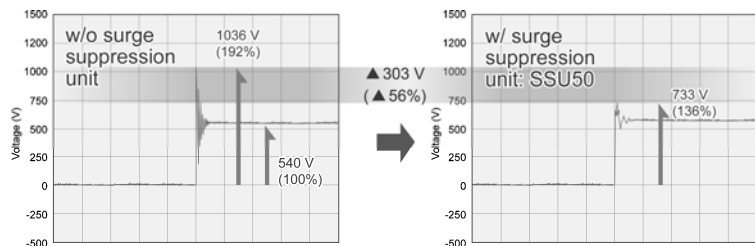

Motor/inverter capacity: 75 kW (100 HP)  
Running status: No-load  
Wiring length: 100 m (328 ft)  
Power supply voltage: Three-phase 400 V

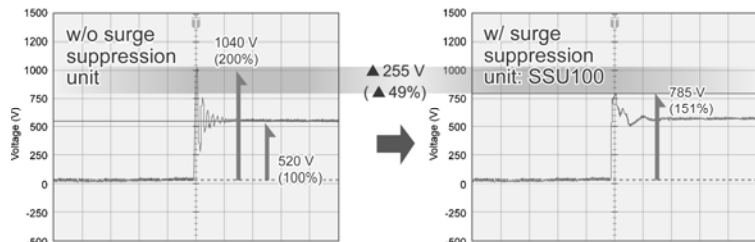

### ■ Basic specifications

Item	Specifications	
Type	SSU 50TA-NS	SSU 100TA-NS
Applicable wiring length	50 m (164 ft) or shorter	100 m (328 ft) or shorter
Power supply voltage	200 V and 400 V classes, PWM converter is applicable	
Inverter capacity	75 kW (100 HP) or below (For 90 kW (125 HP) or above, individually treated.)	
Output frequency	400 Hz or below	
Carrier frequency	15 kHz or below (The SSU is not available at 16 kHz.)	
Enclosure	IP20	
Installation environment	Ambient temp.: -20 to +40°C (-4 to 104°F), Relative humidity: 85% RH or below, Vibration: 0.7 G or less, Installation: Horizontally	
Dielectric strength voltage	2500 VAC, 1 minute	

[ 6 ] Zero-phase reactors for reducing radio noise (ACLs)

An ACL is used to reduce radio frequency noise emitted from the inverter output lines. Pass the total of four wires--three inverter output wires and a grounding wire through the ACL in the same passing direction four times. If shielded wires are used, pass them through the ACL with their shields four times. Be sure to use wires with a heat resistance of 75°C (167°F) or above.

The ACL absorbs high-frequency noise components and emits them as heat into the air so that the amount of heat generation can be large. If it happens, lower the carrier frequency, upgrade the heat-resistance rank of wires, increase the number of the ACLs to decrease the number of turns per ACL, replace the ACLs with higher type ones, or take any other measures.

The wire size is determined depending upon the ACL size (I.D.) and installation requirements. Refer to Table 6.13.

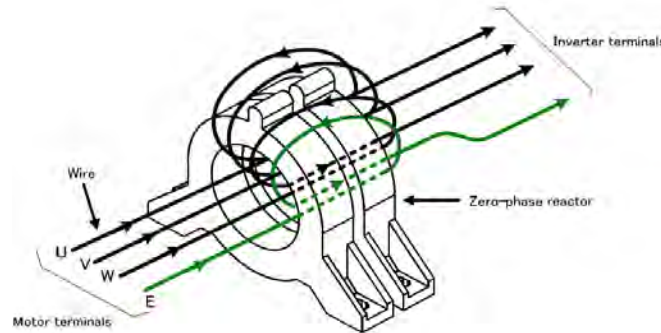
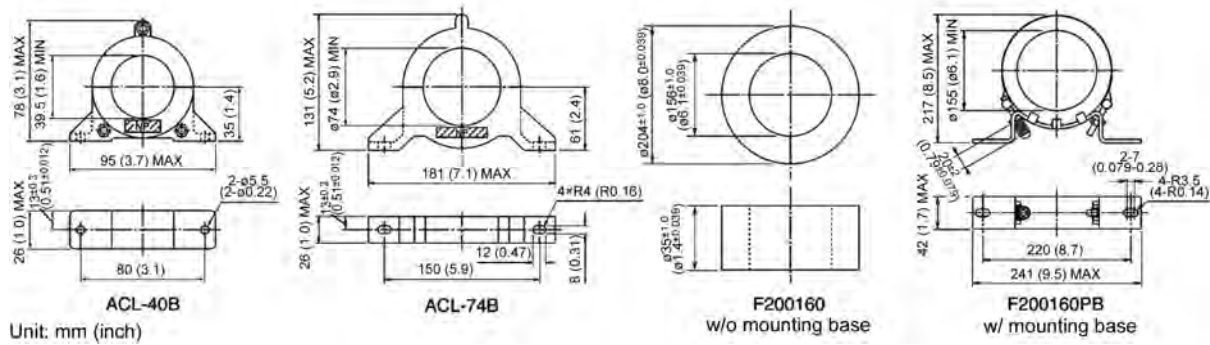

Figure 6.12 Dimensions of ACL and Connection Example

Table 6.13 Wire Size Selection (ACL)

ACL type	Installation requirements		Wire size	
	Q'ty	Number of turns	(mm <sup>2</sup> )	(AWG)
ACL-40B	1	4	5.5 or below	10 or below
	2	2	14 or below	6 or below
	4	1	38 or below	1 or below
ACL-74B	1	4	14 or below	6 or below
	2	2	60 or below	1/0 or below
	4	1	250 or below	500 or below

Be sure to use wires with a heat resistance of 75°C (167°F) or above

## [ 7 ] Options for 100 V single-phase power supply

An optional 100 V single-phase power supply may be used to operate an inverter designed for a 200 V 3-phase power supply with 100 V single-phase power. Select an option with correct capacity according to the specifications listed in Table 6.14.

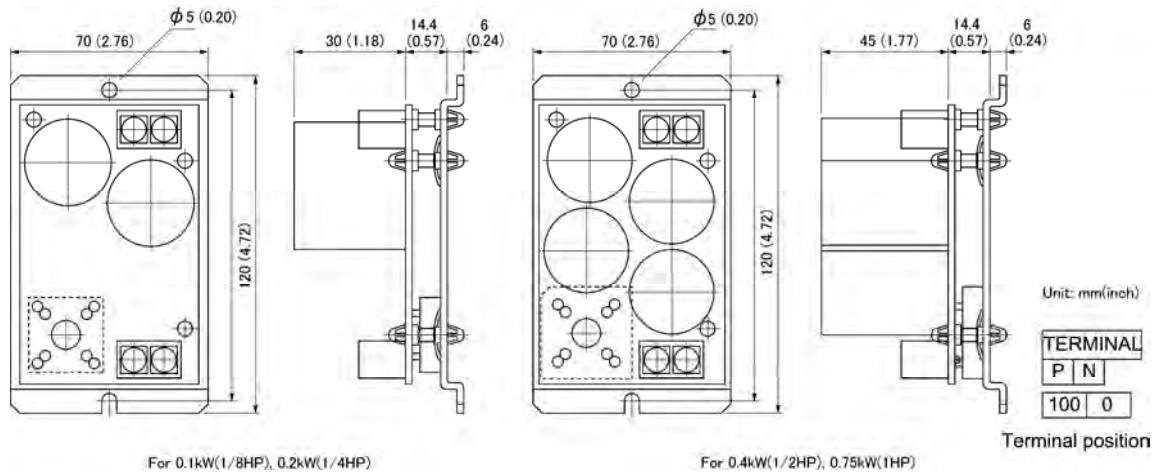

Figure 6.13 Optional Single-Phase 100 V Input Dimensions

Table 6.14 Optional Single-Phase 100 V Input

Type		CAPA6-0.2	CAPA6-0.4	CAPA6-0.75
Applicable inverter capacity	(kW)	0.1 and 0.2	0.4	0.75
	(HP)	1/8 and 1/4	1/2	1
Rated capacity (kVA)		0.5	1.1	1.8



## 6.4.2 Options for operation and communications

### [ 1 ] External potentiometer for frequency setting

An external potentiometer may be used to set the drive frequency. Connect the potentiometer to control signal terminals [11] to [13] of the inverter as shown in Figure 6.14.

**Model: RJ-13 (BA-2 B-characteristics, 1 kΩ)**

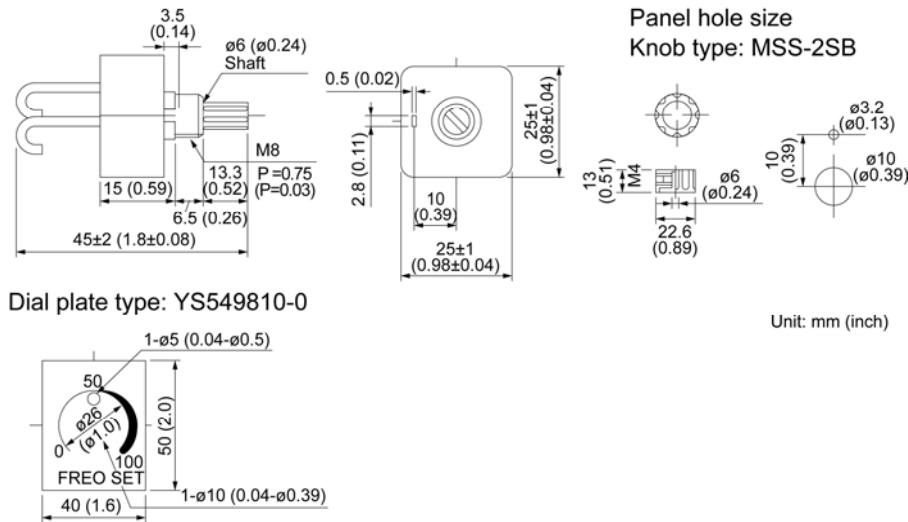

**Model: WAR3W (3W B-characteristics, 1 kΩ)**

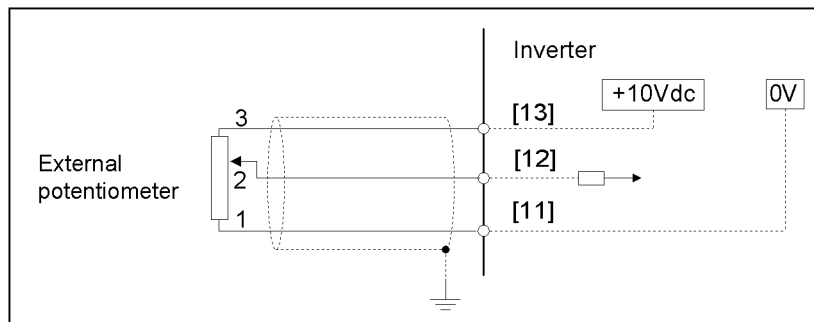
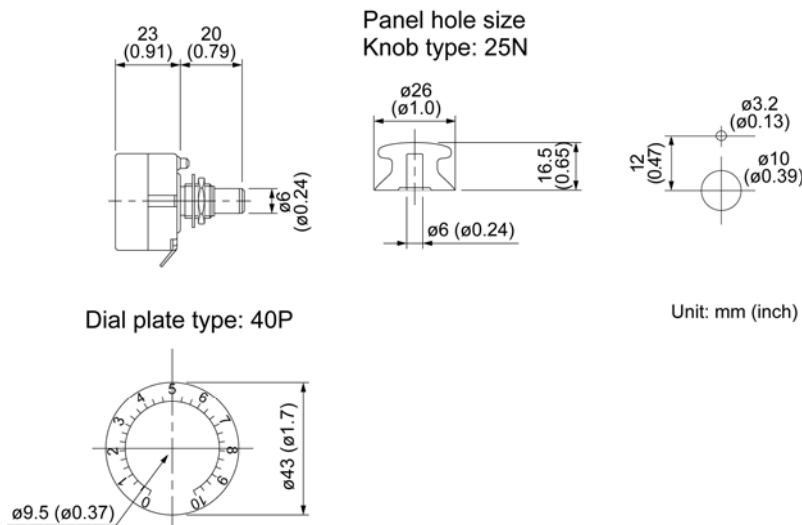
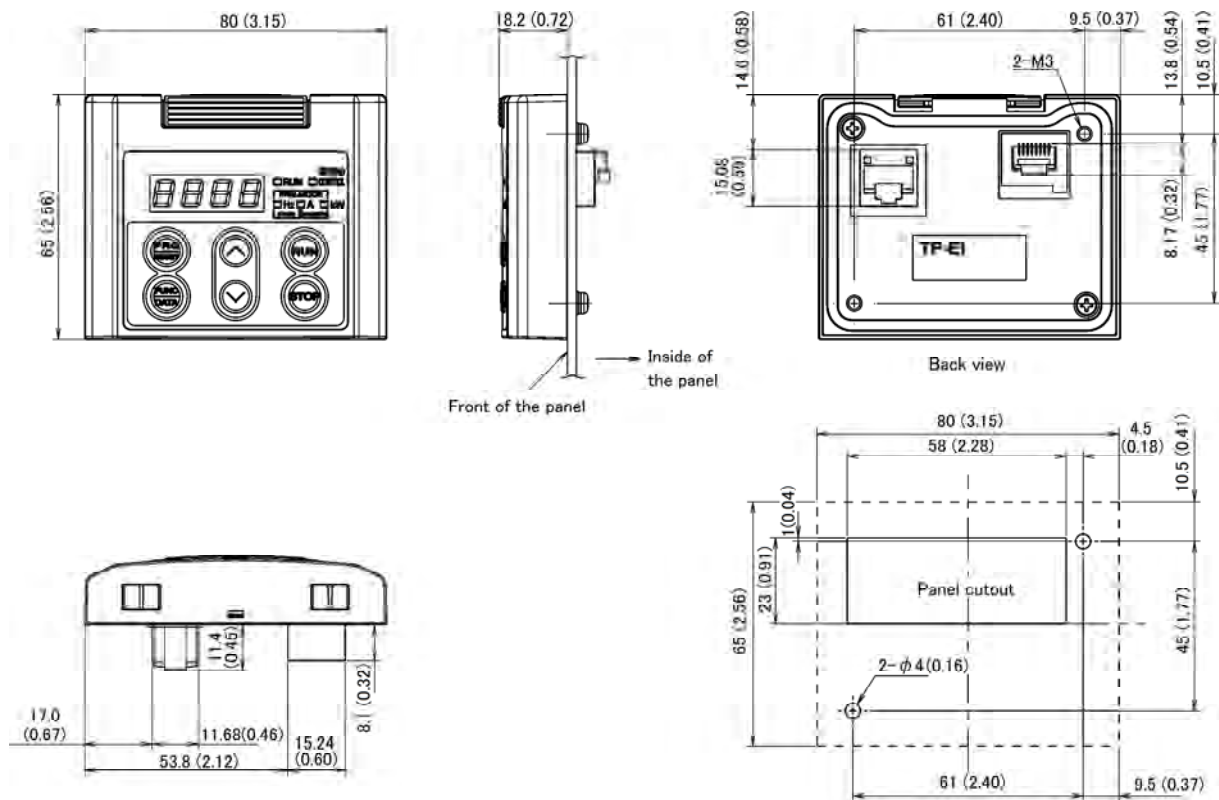

Figure 6.14 External Potentiometer Dimensions and Connection Example

## [ 2 ] Remote keypad "TP-E1"

The keypad permits remote control of FRENIC-Mini, and function setting and display (with copy function).



### [ 3 ] USB-equipped remote keypad (TP-E1U)

Using the keypad in combination with FRENIC Loader enables a variety of data about the inverter unit to be saved in the keypad memory, allowing you to check the information in any place.

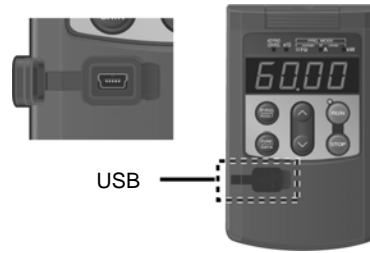

<Example of use in the office>



#### Features

1. The keypad can be directly connected to a computer through a commercial USB cable (mini B) without using a converter. The computer can be connected online with the inverter.
2. With the FRENIC Loader, the inverter can support the following functions (1) to (4).
  - (1) Editing, comparing, and copying the function code data
  - (2) Real-time operation monitor
  - (3) Trouble history (indicating the latest four troubles)
  - (4) Maintenance information

Data can be transferred from the USB port of the keypad directly to the computer (FRENIC Loader) at the site of production.

Periodical collection of life information can be carried out efficiently.

<Example of use at the site of production>



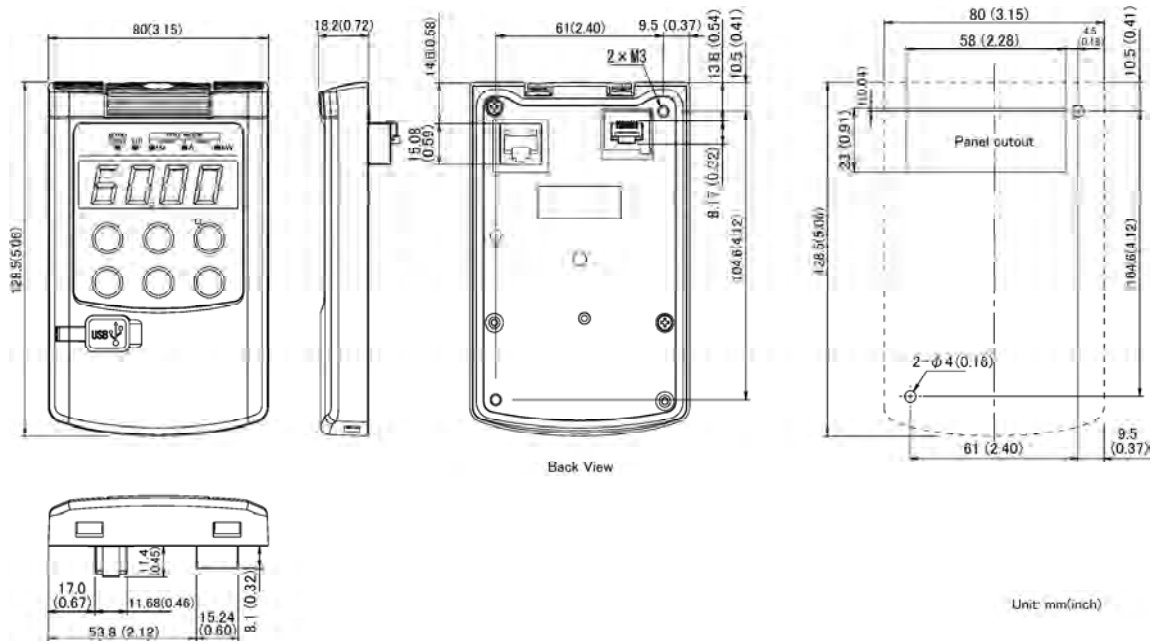

#### [ 4 ] Extension cable for remote operation (CB-□S)

The extension cable connects the inverter with the remote keypad to enable remote operation of the inverter. The cable is a straight-wired type with RJ-45 jacks and its length is selectable from 5 m (16.4 ft), 3 m (9.8 ft), and 1 m (3.3 ft).



Type	Length m (ft)
CB-5S	5 (16.4)
CB-3S	3 (9.8)
CB-1S	1 (3.3)

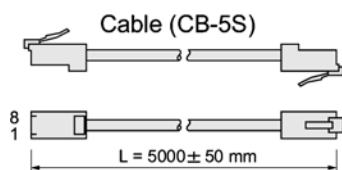

#### [ 5 ] Inverter support loader software

FRENIC Loader is support software which enables the inverter to be operated via the RS-485 communications facility. The main functions include the following:

- Easy editing of function code data
- Monitoring the operation statuses of the inverter such as I/O monitor and multi-monitor
- Operation of inverters on a PC screen (Windows-based only)

 Refer to Chapter 5 "RUNNING THROUGH RS-485 COMMUNICATION" for details.

### 6.4.3 Extended installation kit options

#### [ 1 ] Mounting adapters

FRENIC-Mini series of inverters can be installed in the control board of your system using mounting adapters which utilize the mounting holes used for conventional inverters (FVR-E11S series of 0.75 kW or below or 3.7 (4.0) kW). The FVR-E11S-2/4 (1.5 kW/2.2 kW) and FVR-E11S-7 (0.75 kW/1.5 kW) models may be replaced with the FRENIC-Mini series inverters without the use of adapters.

Table 6.15 Mounting Adapters

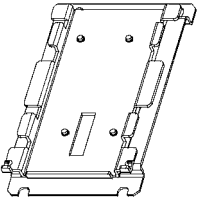
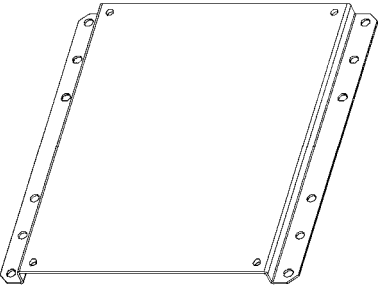
Option model	Applicable inverter model	
	FRENIC-Mini	FVR-E11S
MA-C1-0.75 	FRN0001C2S-2□ FRN0002C2S-2□ FRN0004C2S-2□ FRN0006C2S-2□ FRN0001C2S-7□ FRN0002C2S-7□ FRN0004C2S-7□ FRN0006C2S-7□	FVR0.1E11S-2□ FVR0.2E11S-2□ FVR0.4E11S-2□ FVR0.75E11S-2□ FVR0.1E11S-7□ FVR0.2E11S-7□ FVR0.4E11S-7□
MA-C1-3.7 	FRN0020C2S-2□ FRN0011C2S-4□ FRN0012C2S-7□	FVR3.7E11S-2□ FVR3.7E11S-4□ FVR4.0E11S-4□ FVR2.2E11S-7□

Note: A box (□) in the above table replaces A, C, E, or U depending on shipping destination.

## [ 2 ] Rail mounting bases

A rail mounting base allows any of the FRENIC-Mini series of inverter to be mounted on a DIN rail (35 mm (1.38 inches) wide).

Table 6.16 Rail Mounting Base

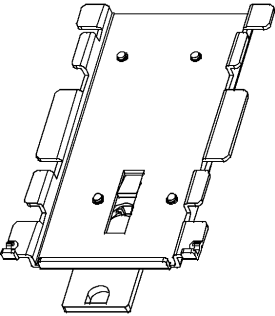
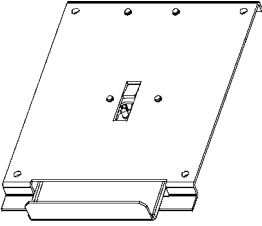
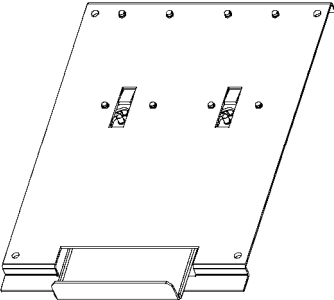
Option model	Applicable inverter type
<p>RMA-C1-0.75</p> 	<p>FRN0001C2S-2□  FRN0002C2S-2□  FRN0004C2S-2□  FRN0006C2S-2□</p> <hr/> <p>FRN0001C2S-7□  FRN0002C2S-7□  FRN0004C2S-7□  FRN0006C2S-7□</p> <hr/> <p>FRN0001C2S-6U  FRN0002C2S-6U  FRN0003C2S-6U</p> <hr/> <p>FRN0001C2E-7□  FRN0002C2E-7□  FRN0004C2E-7□</p>
<p>RMA-C1-2.2</p> 	<p>FRN0010C2S-2□  FRN0012C2S-2□</p> <hr/> <p>FRN0002C2S-4□  FRN0004C2S-4□  FRN0005C2S-4□  FRN0007C2S-4□</p> <hr/> <p>FRN0010C2S-7□</p> <hr/> <p>FRN0002C2E-4□  FRN0004C2E-4□</p> <hr/> <p>FRN0006C2E-7□</p>
<p>RMA-C1-3.7</p> 	<p>FRN0020C2S-2□</p> <hr/> <p>FRN0011C2S-4□</p> <hr/> <p>FRN0012C2S-7□</p> <hr/> <p>FRN0005C2E-4□  FRN0007C2E-4□  FRN0011C2E-4□</p> <hr/> <p>FRN0010C2E-7□  FRN0012C2E-7□</p>

Note 1: A box (□) in the above table replaces A, C, E, or U depending on shipping destination.

Note 2: This rail mounting base is not suitable for the inverters of 5.5 kW (7.5 HP) or above.

### [ 3 ] NEMA1 kit (NEMA1-□□□C2-□ )

Mounting the NEMA1 kit on the FRENIC-Mini series of inverters brings the inverter's enclosure into compliance with the NEMA1 Standard (UL TYPE1 certified).

Table 6.17 NEMA1 Kit

Power supply voltage	Inverter type	Option type	Figure	
Three-phase 200 V	FRN0001C2S-2□	NEMA1-C2-101	A	
	FRN0002C2S-2□			
	FRN0004C2S-2□	NEMA1-C2-102		
	FRN0006C2S-2□	NEMA1-C2-103		
	FRN0010C2S-2□	NEMA1-C2-201		B
	FRN0012C2S-2□			
	FRN0020C2S-2□	NEMA1-C2-301	C	
Three-phase 400 V	FRN0002C2S-4□	NEMA1-C2-202	A	
	FRN0004C2S-4□	NEMA1-C2-203	B	
	FRN0005C2S-4□	NEMA1-C2-201		
	FRN0007C2S-4□			
	FRN0011C2S-4□	NEMA1-C2-301	C	
Single-phase 200 V	FRN0001C2S-7□	NEMA1-C2-101	A	
	FRN0002C2S-7□			
	FRN0004C2S-7□	NEMA1-C2-102		
	FRN0006C2S-7□	NEMA1-C2-104		
	FRN0010C2S-7□	NEMA1-C2-204		B
	FRN0012C2S-7□	NEMA1-C2-301		C
Single-phase 100 V	FRN0001C2S-6U	NEMA1-C2-105	A	
	FRN0002C2S-6U			
	FRN0003C2S-6U	NEMA1-C2-106		
	FRN0005C2S-6U	NEMA1-C2-205		

This option is not applicable to the EMC filter built-in type or inverters of 5.5 kW or above.



Figure A

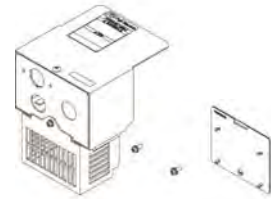

Figure B

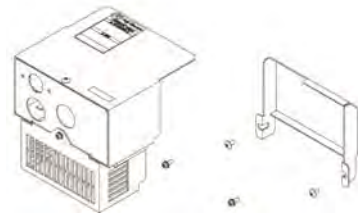

Figure C

## 6.4.4 Meter options

### [ 1 ] Frequency meters

Connect a frequency meter to analog signal output terminals [FMA] (+) and [11] (-) of the inverter to measure the frequency component selected by function code F31. Figure 6.15 shows the dimensions of the frequency meter and a connection example.

**Model: TRM-45 (10 VDC, 1 mA)**

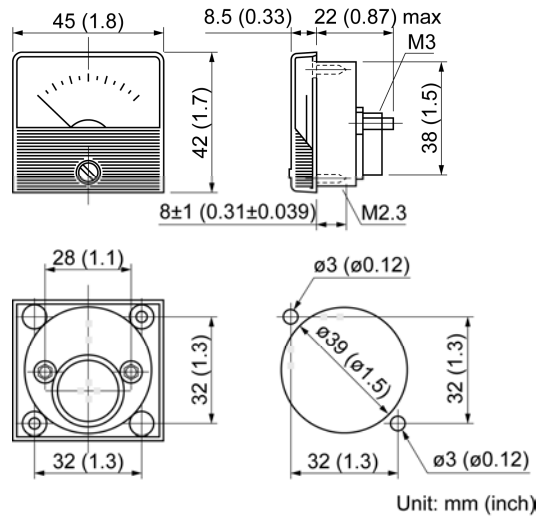

**Model: FMN-60 (10 VDC, 1 mA)**

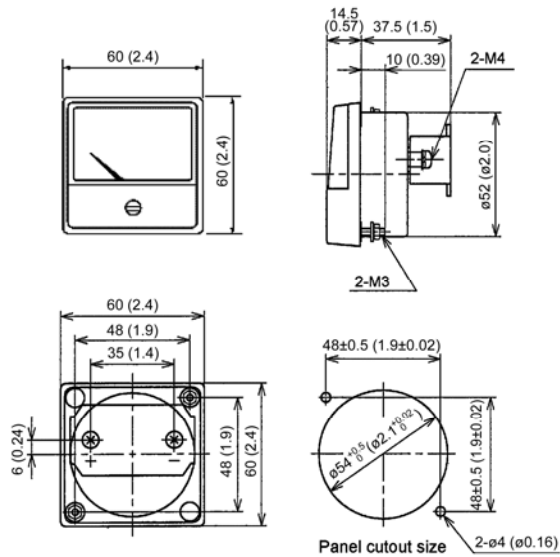

**Model: FMN-80 (10 VDC, 1 mA)**

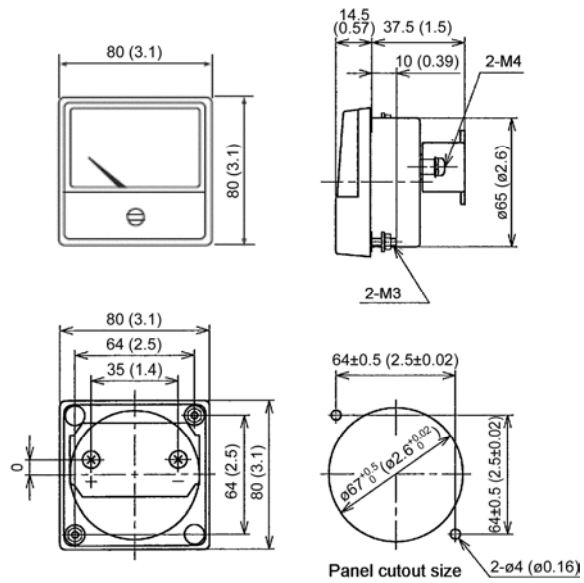

Unit: mm (inch)

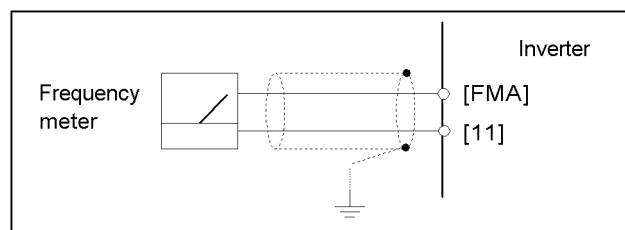

Figure 6.15 Frequency Meter Dimensions and Connection Example



# Chapter 7

## SELECTING OPTIMAL MOTOR AND INVERTER CAPACITIES

This chapter provides you with information about the inverter output torque characteristics, selection procedure, and equations for calculating capacities to help you select optimal motor and inverter models. It also helps you select braking resistors.

### Contents

7.1	Selecting Motors and Inverters .....	7-1
7.1.1	Motor output torque characteristics.....	7-1
7.1.2	Selection procedure.....	7-4
7.1.3	Equations for selections .....	7-7
7.1.3.1	Load torque during constant speed running .....	7-7
[ 1 ]	General equation .....	7-7
[ 2 ]	Obtaining the required force F .....	7-7
7.1.3.2	Acceleration and deceleration time calculation.....	7-8
[ 1 ]	Calculation of moment of inertia.....	7-8
[ 2 ]	Calculation of the acceleration time .....	7-10
[ 3 ]	Calculation of the deceleration time.....	7-10
7.1.3.3	Heat energy calculation of braking resistor .....	7-11
[ 1 ]	Calculation of regenerative energy.....	7-11
7.1.3.4	Calculating the RMS rating of the motor .....	7-12
7.2	Selecting a Braking Resistor .....	7-13
7.2.1	Selection procedure.....	7-13
7.2.2	Notes on selection .....	7-13



## 7.1 Selecting Motors and Inverters

When selecting a general-purpose inverter, first select a motor and then inverter as follows:

- (1) Key point for selecting a motor: Determine what kind of load machine is to be used, calculate its moment of inertia, and then select the appropriate motor capacity
- (2) Key point for selecting an inverter: Taking into account the operation requirements (e.g., acceleration time, deceleration time, and frequency in operation) of the load machine to be driven by the motor selected in (1) above, calculate the acceleration/deceleration/braking torque.

This section describes the selection procedure for (1) and (2) above. First, it explains the output torque obtained by using the motor driven by the inverter (FRENIC-Mini).

### 7.1.1 Motor output torque characteristics

Figures 7.1 and 7.2 graph the output torque characteristics of motors at the rated output frequency individually for 50 Hz and 60 Hz base. The horizontal and vertical axes show the output frequency and output torque (%), respectively. Curves (a) through (f) depend on the running conditions.

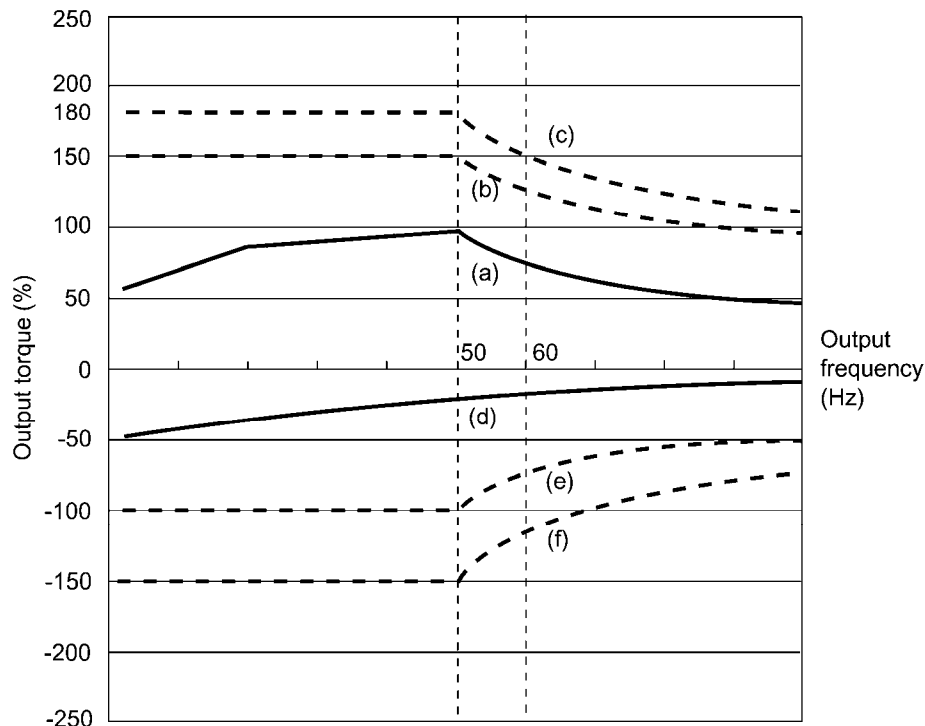

Figure 7.1 Output Torque Characteristics (Base frequency: 50 Hz)

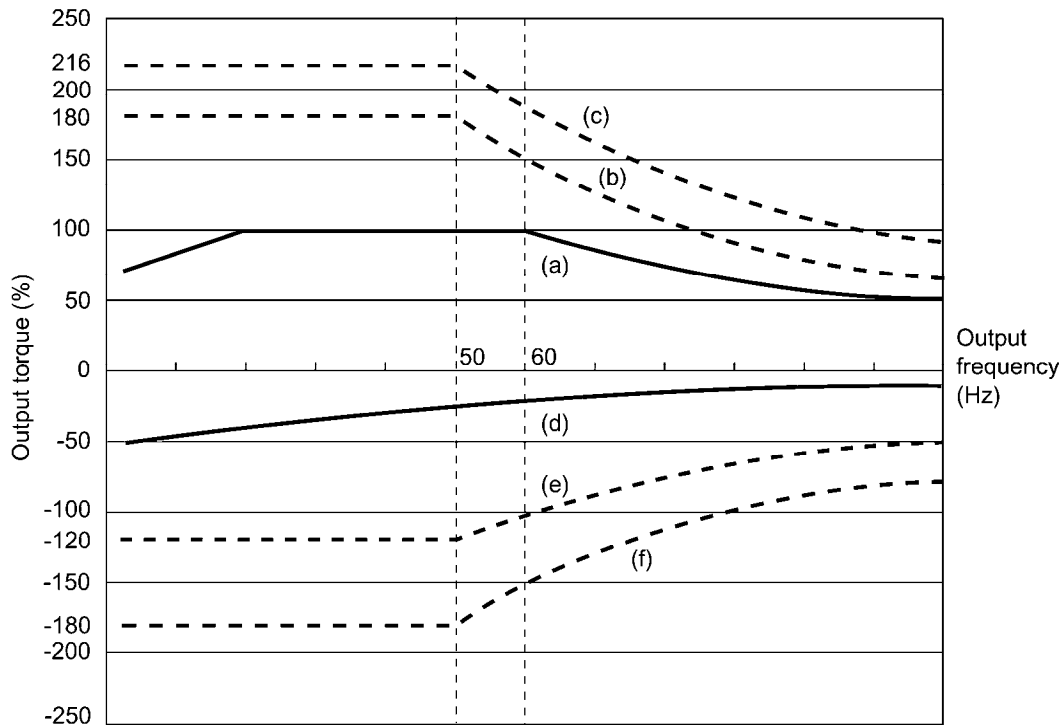

Figure 7.2 Output Torque Characteristics (Base frequency: 60 Hz)

(1) Continuous allowable driving torque (Curve (a) in Figures 7.1 and 7.2)

Curve (a) shows the torque characteristic that can be obtained in the range of the inverter continuous rated current, where the motor cooling characteristic is taken into consideration. When the motor runs at the base frequency of 60 Hz, 100 % output torque can be obtained; at 50 Hz, the output torque is somewhat lower than that in commercial power, and it further lowers at lower frequencies. The reduction of the output torque at 50 Hz is due to increased loss by inverter driving, and that at lower frequencies is mainly due to heat generation caused by the decreased ventilation performance of the motor cooling fan.

(2) Maximum driving torque in a short time (Curves (b) and (c) in Figures 7.1 and 7.2)

Curve (b) shows the torque characteristic that can be obtained in the range of the inverter rated current in a short time (the output torque is 150% for one minute) when torque-vector control is enabled. At that time, the motor cooling characteristics have little effect on the output torque.

Curve (c) shows an example of the torque characteristic when one class higher capacity inverter is used to increase the short-time maximum torque. In this case, the short-time torque is 20 to 30% greater than that when the standard capacity inverter is used.

(3) Starting torque (around the output frequency 0 Hz in Figures 7.1 and 7.2)

The maximum torque in a short time applies to the starting torque as it is.

(4) Braking torque (Curves (d), (e), and (f) in Figures 7.1 and 7.2)

In braking the motor, kinetic energy is converted to electrical energy and regenerated to the DC link bus capacitor (reservoir capacitor) of the inverter. Discharging this electrical energy to the braking resistor produces a large braking torque as shown in curve (e). If no braking resistor is provided, however, only the motor and inverter losses consume the regenerated braking energy so that the torque becomes smaller as shown in curve (d).

When an optional braking resistor is used, the braking torque is allowable only for a short time. Its time ratings are mainly determined by the braking resistor ratings. This manual and associated catalogs list the allowable values (kW) obtained from the average discharging loss and allowable values (kWs) obtained from the discharging capability that can be discharged at one time.

Note that the torque % value varies according to the inverter capacity.

Selecting an optimal braking unit enables a braking torque value to be selected comparatively freely in the range below the short-time maximum torque in the driving mode, as shown in curve (f).



For braking-related values when the inverter and braking resistor are normally combined, refer to Chapter 6, Section 6.4.1 [1] "Braking resistors."

## 7.1.2 Selection procedure

Figure 7.3 shows the general selection procedure for optimal inverters. Items numbered (1) through (5) are described on the following pages.

You may easily select inverter capacity if there are no restrictions on acceleration and deceleration times. If "there are any restrictions on acceleration or deceleration time" or "acceleration and deceleration are frequent," then the selection procedure is more complex.

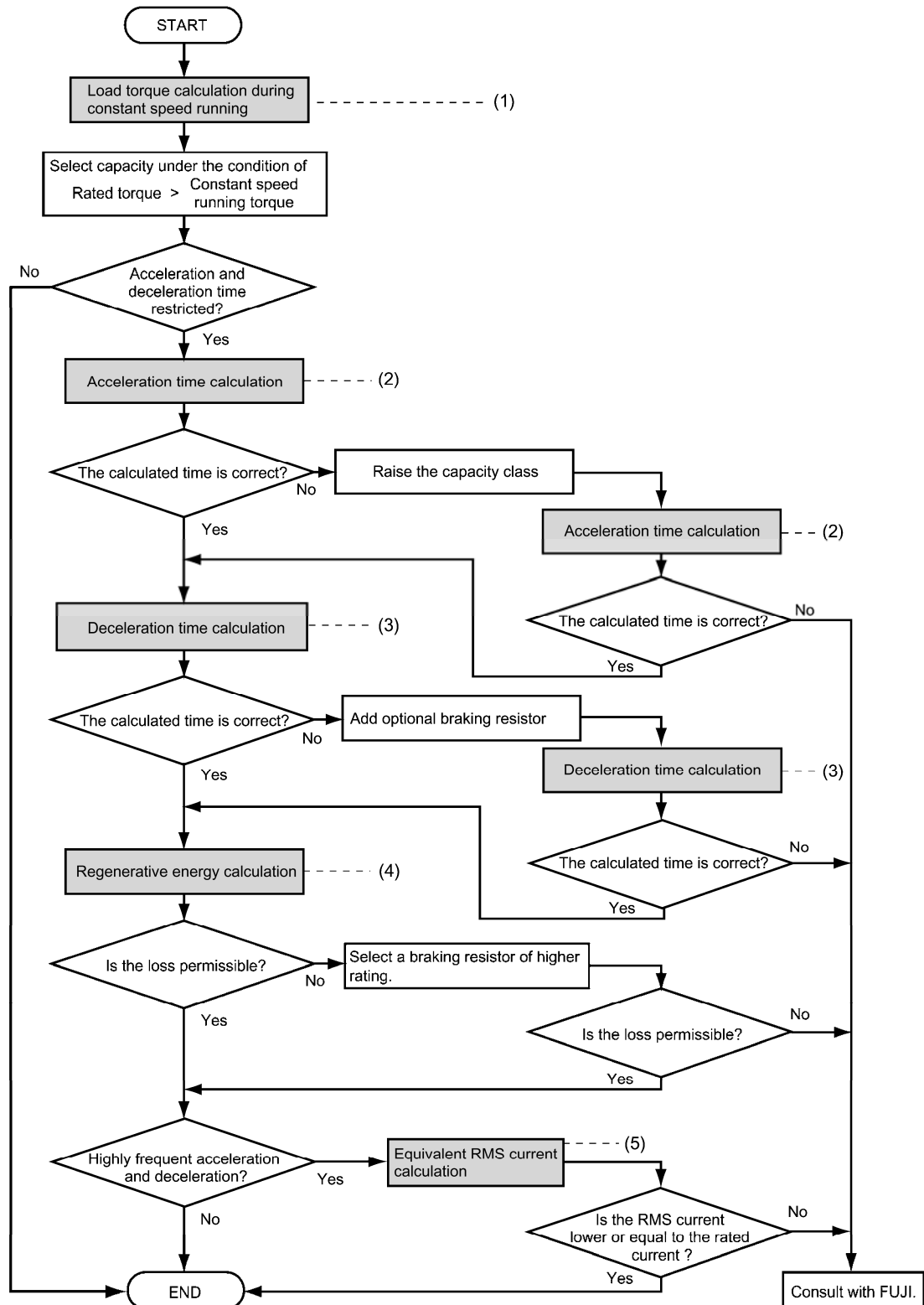

Figure 7.3 Selection Procedure

- (1) Calculating the load torque during constant speed running (For detailed calculation, refer to Section 7.1.3.1)

It is essential to calculate the load torque during constant speed running for all loads.

First calculate the load torque of the motor during constant speed running and then select a tentative capacity so that the continuous rated torque of the motor during constant speed running becomes higher than the load torque. To perform capacity selection efficiently, it is necessary to match the rated speeds (base speeds) of the motor and load. To do this, select an appropriate reduction-gear (mechanical transmission) ratio and the number of motor poles.

If the acceleration or deceleration time is not restricted, the tentative capacity can apply as a defined capacity.

- (2) Calculating the acceleration time (For detailed calculation, refer to Section 7.1.3.2)

When there are some specified requirements for the acceleration time, calculate it according to the following procedure:

- 1) Calculate the moment of inertia for the load and motor

Calculate the moment of inertia for the load, referring to Section 7.1.3.2, "Acceleration and deceleration time calculation." For the motor, refer to the related motor catalogs.

- 2) Calculate the minimum acceleration torque (See Figure 7.4)

The acceleration torque is the difference between the motor short-time output torque (base frequency: 60 Hz) explained in Section 7.1.1 (2), "Maximum driving torque in a short time" and the load torque ( $\tau_L / \eta_G$ ) during constant speed running calculated in the above (1). Calculate the minimum acceleration torque for the whole range of speed.

- 3) Calculate the acceleration time

Assign the value calculated above to the equation (7.10) in Section 7.1.3.2, "Acceleration and deceleration time calculation" to calculate the acceleration time. If the calculated acceleration time is longer than the expected time, select the inverter and motor having one class larger capacity and calculate it again.

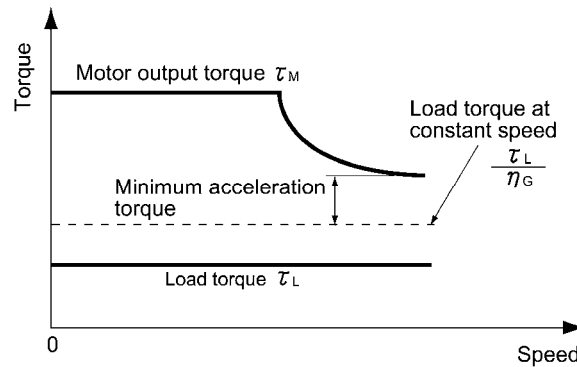

Figure 7.4 Example Study of Minimum Acceleration Torque

(3) Deceleration time (For detailed calculation, refer to Section 7.1.3.2)

To calculate the deceleration time, check the motor deceleration torque characteristics for the whole range of speed in the same way as for the acceleration time.

- 1) Calculate the moment of inertia for the load and motor  
Same as for the acceleration time.
- 2) Calculate the minimum deceleration torque (See Figures 7.5 and 7.6.)  
Same as for the acceleration time.
- 3) Calculate the deceleration time  
Assign the value calculated above to the equation (7.11) to calculate the deceleration time in the same way as for the acceleration time. If the calculated deceleration time is longer than the requested time, select the inverter and motor having one class larger capacity and calculate it again.

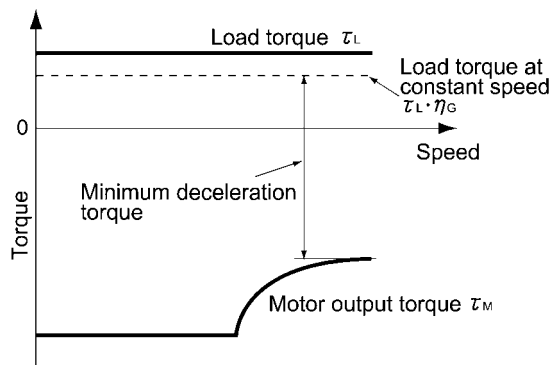

Figure 7.5 Example Study of Minimum Deceleration Torque (1)

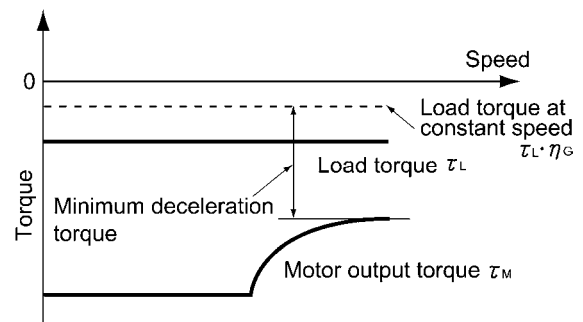

Figure 7.6 Example Study of Minimum Deceleration Torque (2)

(4) Braking resistor rating (For detailed calculation, refer to Section 7.1.3.3)

Braking resistor rating is classified into two types according to the braking periodic duty cycle.

- 1) When the periodic duty cycle is shorter than 100 sec:  
Calculate the average loss to determine rated values.
- 2) When the periodic duty cycle is 100 sec or longer:  
The allowable braking energy depends on the maximum regenerative braking power. The allowable values are listed in Chapter 6, Section 6.4.1 [1] "Braking resistors."

(5) Motor RMS current (For detailed calculation, refer to Section 7.1.3.4)

In metal processing machine and materials handling machines requiring positioning control, highly frequent running for a short time is repeated. In this case, calculate the maximum equivalent RMS current value (effective value of current) not to exceed the allowable value (rated current) for the motor.



## 7.1.3 Equations for selections

### 7.1.3.1 Load torque during constant speed running

#### [ 1 ] General equation

The frictional force acting on a horizontally moved load must be calculated. Calculation for driving a load along a straight line with the motor is shown below.

Where the force to move a load linearly at constant speed  $v$  (m/s) is  $F$  (N) and the motor speed for driving this is  $N_M$  (r/min), the required motor output torque  $\tau_M$  (N·m) is as follows:

$$\tau_M = \frac{60 \cdot v}{2 \pi \cdot N_M} \cdot \frac{F}{\eta_G} \quad (\text{N} \cdot \text{m}) \quad (7.1)$$

where,  $\eta_G$  is Reduction-gear efficiency.

When the inverter brakes the motor, efficiency works inversely, so the required motor torque should be calculated as follows:

$$\tau_M = \frac{60 \cdot v}{2 \pi \cdot N_M} \cdot F \cdot \eta_G \quad (\text{N} \cdot \text{m}) \quad (7.2)$$

$(60 \cdot v) / (2 \pi \cdot N_M)$  in the above equation is an equivalent turning radius corresponding to speed  $v$  around the motor shaft.

The value  $F$  (N) in the above equations depends on the load type.

#### [ 2 ] Obtaining the required force F

Moving a load horizontally

A simplified mechanical configuration is assumed as shown in Figure 7.7. If the mass of the carrier table is  $W_0$  kg, the load is  $W$  kg, and the friction coefficient of the ball screw is  $\mu$ , then the friction force  $F$  (N) is expressed as follows, which is equal to a required force for driving the load:

$$F = (W_0 + W) \cdot g \cdot \mu \quad (\text{N}) \quad (7.3)$$

where,  $g$  is the gravity acceleration ( $\approx 9.8 \text{ m/s}^2$ ).

Then, the required output torque around the motor shaft is expressed as follows:

$$\tau_M = \frac{60 \cdot v}{2 \pi \cdot N_M} \cdot \frac{(W_0 + W) \cdot g \cdot \mu}{\eta_G} \quad (\text{N} \cdot \text{m}) \quad (7.4)$$

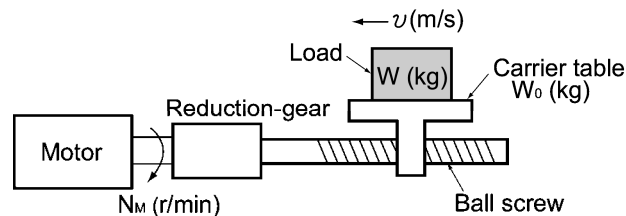

Figure 7.7 Moving a Load Horizontally

### 7.1.3.2 Acceleration and deceleration time calculation

When an object whose moment of inertia is  $J$  ( $\text{kg}\cdot\text{m}^2$ ) rotates at the speed  $N$  (r/min), it has the following kinetic energy:

$$E = \frac{J}{2} \cdot \left(\frac{2\pi \cdot N}{60}\right)^2 \quad (\text{J}) \quad (7.5)$$

To accelerate the above rotational object, the kinetic energy will be increased; to decelerate the object, the kinetic energy must be discharged. The torque required for acceleration and deceleration can be expressed as follows:

$$\tau = J \cdot \frac{2\pi}{60} \left(\frac{dN}{dt}\right) \quad (\text{N}\cdot\text{m}) \quad (7.6)$$

This way, the mechanical moment of inertia is an important element in the acceleration and deceleration. First, calculation method of moment of inertia is described, then those for acceleration and deceleration time are explained.

#### [ 1 ] Calculation of moment of inertia

For an object that rotates around the rotation axis, virtually divide the object into small segments and square the distance from the rotation axis to each segment. Then, sum the squares of the distances and the masses of the segments to calculate the moment of inertia.

$$J = \sum (W_i \cdot r_i^2) \quad (\text{kg}\cdot\text{m}^2) \quad (7.7)$$

The following describes equations to calculate moment of inertia having different shaped loads or load systems.

##### (1) Hollow cylinder and solid cylinder

The common shape of a rotating body is hollow cylinder. The moment of inertia around the hollow cylinder center axis can be calculated as follows, where the outer and inner diameters are  $D_1$  and  $D_2$  [m] and total mass is  $W$  [kg] in Figure 7.8.

$$J = \frac{W \cdot (D_1^2 + D_2^2)}{8} \quad (\text{kg}\cdot\text{m}^2) \quad (7.8)$$

For a similar shape, a solid cylinder, calculate the moment of inertia as  $D_2$  is 0.

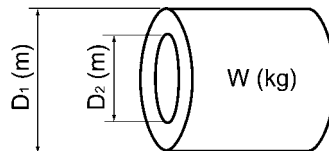
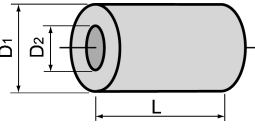
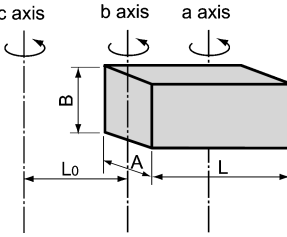
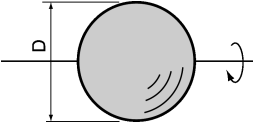
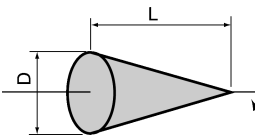
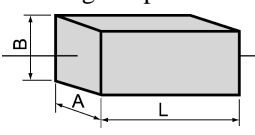
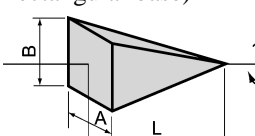
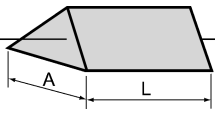
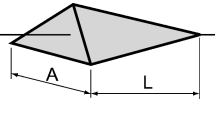
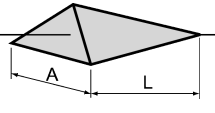

Figure 7.8 Hollow Cylinder

##### (2) For a general rotating body

Table 7.1 lists the calculation equations of moment of inertia of various rotating bodies including the above cylindrical rotating body.

Table 7.1 Moment of Inertia of Various Rotating Bodies

Shape	Mass: W (kg) Moment of inertia: J (kg·m <sup>2</sup> )	Shape	Mass: W (kg) Moment of inertia: J (kg·m <sup>2</sup> )
	$W = \frac{\pi}{4} \cdot (D_1^2 - D_2^2) \cdot L \cdot \rho$ $J = \frac{1}{8} \cdot W \cdot (D_1^2 + D_2^2)$		$W = A \cdot B \cdot L \cdot \rho$ $J_a = \frac{1}{12} \cdot W \cdot (L^2 + A^2)$ $J_b = \frac{1}{12} \cdot W \cdot (L^2 + \frac{1}{4} \cdot A^2)$ $J_c \approx W \cdot (L_0^2 + L_0 \cdot L + \frac{1}{3} \cdot L^2)$
	$W = \frac{\pi}{6} \cdot D^3 \cdot \rho$ $J = \frac{1}{10} \cdot W \cdot D^2$		$W = \frac{\pi}{4} \cdot D^2 \cdot L \cdot \rho$ $J_a = \frac{1}{12} \cdot W \cdot (L^2 + \frac{3}{4} \cdot D^2)$ $J_b = \frac{1}{3} \cdot W \cdot (L^2 + \frac{3}{16} \cdot D^2)$ $J_c \approx W \cdot (L_0^2 + L_0 \cdot L + \frac{1}{3} \cdot L^2)$
	$W = A \cdot B \cdot L \cdot \rho$ $J = \frac{1}{12} \cdot W \cdot (A^2 + B^2)$		$W = \frac{1}{3} \cdot A \cdot B \cdot L \cdot \rho$ $J_b = \frac{1}{10} \cdot W \cdot (L^2 + \frac{1}{4} \cdot A^2)$ $J_c \approx W \cdot (L_0^2 + \frac{3}{2} \cdot L_0 \cdot L + \frac{3}{5} \cdot L^2)$
	$W = \frac{\sqrt{3}}{4} \cdot A^2 \cdot L \cdot \rho$ $J = \frac{1}{3} \cdot W \cdot A^2$		$W = \frac{\pi}{12} \cdot D^2 \cdot L \cdot \rho$ $J_b = \frac{1}{10} \cdot W \cdot (L^2 + \frac{3}{8} \cdot D^2)$ $J_c \approx W \cdot (L_0^2 + \frac{3}{2} \cdot L_0 \cdot L + \frac{3}{5} \cdot L^2)$
	$W = \frac{\sqrt{3}}{12} \cdot A^2 \cdot L \cdot \rho$ $J = \frac{1}{5} \cdot W \cdot A^2$	<p>Main metal density (at 20°C (68°F)) ρ(kg/m<sup>3</sup>)    Iron: 7860, Copper: 8940, Aluminum: 2700</p>	

### (3) For a load running horizontally

Assume a carrier table driven by a motor as shown in Figure 7.7. If the table speed is  $v$  (m/s) when the motor speed is  $N_M$  (r/min), then an equivalent distance from the rotation axis is equal to  $60 \cdot v / (2\pi \cdot N_M)$  m. The moment of inertia of the table and load to the rotation axis is calculated as follows:

$$J = \left( \frac{60 \cdot v}{2\pi \cdot N_M} \right)^2 \cdot (W_0 + W) \quad (\text{kg} \cdot \text{m}^2) \quad (7.9)$$

## [ 2 ] Calculation of the acceleration time

Figure 7.9 shows a general load model. Assume that a motor drives a load via a reduction-gear with efficiency  $\eta_G$ . The time required to accelerate this load to a speed of  $N_M$  (r/min) is calculated with the following equation:

$$t_{\text{ACC}} = \frac{J_1 + J_2/\eta_G}{\tau_M - \tau_L/\eta_G} \cdot \frac{2\pi \cdot (N_M - 0)}{60} \quad (\text{s}) \quad (7.10)$$

where,

$J_1$ : Motor shaft moment of inertia ( $\text{kg} \cdot \text{m}^2$ )

$J_2$ : Load shaft moment of inertia converted to motor shaft ( $\text{kg} \cdot \text{m}^2$ )

$\tau_M$ : Minimum motor output torque in driving motor (N·m)

$\tau_L$ : Maximum load torque converted to motor shaft (N·m)

$\eta_G$ : Reduction-gear efficiency.

As clarified in the above equation, the equivalent moment of inertia becomes  $(J_1 + J_2/\eta_G)$  by considering the reduction-gear efficiency.

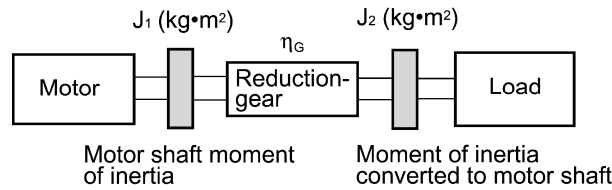

Figure 7.9 Load Model Including Reduction-gear

## [ 3 ] Calculation of the deceleration time

In a load system shown in Figure 7.9, the time needed to stop the motor rotating at a speed of  $N_M$  (r/min) is calculated with the following equation:

$$t_{\text{DEC}} = \frac{J_1 + J_2 \cdot \eta_G}{\tau_M - \tau_L \cdot \eta_G} \cdot \frac{2\pi \cdot (0 - N_M)}{60} \quad (\text{s}) \quad (7.11)$$

where,

$J_1$ : Motor shaft moment of inertia ( $\text{kg} \cdot \text{m}^2$ )

$J_2$ : Load shaft moment of inertia converted to motor shaft ( $\text{kg} \cdot \text{m}^2$ )

$\tau_M$ : Minimum motor output torque in braking (or decelerating) motor (N·m)

$\tau_L$ : Maximum load torque converted to motor shaft (N·m)

$\eta_G$ : Reduction-gear efficiency

In the above equation, generally output torque  $\tau_M$  is negative and load torque  $\tau_L$  is positive. So, deceleration time becomes shorter.

### 7.1.3.3 Heat energy calculation of braking resistor

If the inverter brakes the motor, the kinetic energy of mechanical load is converted to electric energy to be regenerated into the inverter circuit. This regenerative energy is often consumed in so-called braking resistors as heat. The following explains the braking resistor rating.

#### [ 1 ] Calculation of regenerative energy

In the inverter operation, one of the regenerative energy sources is the kinetic energy that is generated at the time an object is moved by an inertial force.

Kinetic energy of a moving object

When an object with moment of inertia  $J$  ( $\text{kg}\cdot\text{m}^2$ ) rotates at a speed  $N_2$  (r/min), its kinetic energy is as follows:

$$E = \frac{J}{2} \cdot \left( \frac{2\pi \cdot N_2}{60} \right)^2 \quad (\text{J}) \quad (7.12)$$

$$\approx \frac{1}{182.4} \cdot J \cdot N_2^2 \quad (\text{J}) \quad (7.12)'$$

When this object is decelerated to a speed  $N_1$  (r/min), the output energy is as follows:

$$E = \frac{J}{2} \cdot \left[ \left( \frac{2\pi \cdot N_2}{60} \right)^2 - \left( \frac{2\pi \cdot N_1}{60} \right)^2 \right] \quad (\text{J}) \quad (7.13)$$

$$\approx \frac{1}{182.4} \cdot J \cdot (N_2^2 - N_1^2) \quad (\text{J}) \quad (7.13)'$$

The energy regenerated to the inverter as shown in Figure 7.9 is calculated from the reduction-gear efficiency  $\eta_G$  and motor efficiency  $\tau_M$  as follows:

$$E \approx \frac{1}{182.4} \cdot (J_1 + J_2 \cdot \eta_G) \cdot \eta_M \cdot (N_2^2 - N_1^2) \quad (\text{J}) \quad (7.14)$$

### 7.1.3.4 Calculating the RMS rating of the motor

In case of the load which is repeatedly and very frequently driven by a motor, the load current fluctuates largely and enters the short-time rating range of the motor repeatedly. Therefore, you have to review the thermal allowable rating of the motor. The heat value is assumed to be approximately proportional to the square of the load current.

If an inverter drives a motor in duty cycles that are much shorter than the thermal time constant of the motor, calculate the "equivalent RMS current" as mentioned below, and select the motor so that this RMS current will not exceed the rated current of the motor.

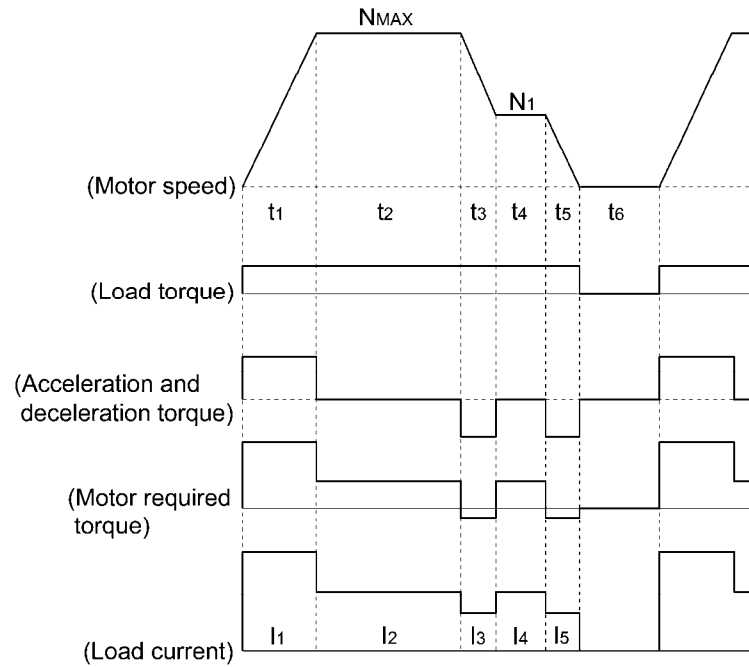

Figure 7.10 Sample of the Repetitive Operation

First, calculate the required torque of each part based on the speed pattern. Then using the torque-current curve of the motor, convert the torque to the load current. The "equivalent RMS current,  $I_{eq}$ " can be finally calculated by the following equation:

$$I_{eq} = \sqrt{\frac{I_1^2 \cdot t_1 + I_2^2 \cdot t_2 + I_3^2 \cdot t_3 + I_4^2 \cdot t_4 + I_5^2 \cdot t_5}{t_1 + t_2 + t_3 + t_4 + t_5 + t_6}} \quad (A) \quad (7.15)$$

The torque-current curve for the dedicated motor is not available for actual calculation. Therefore, calculate the load current  $I$  from the load torque  $\tau_1$  using the following equation (7.16). Then, calculate the equivalent current  $I_{eq}$ :

$$I = \sqrt{\left(\frac{\tau_1}{100} \times I_{t100}\right)^2 + I_{m100}^2} \quad (A) \quad (7.16)$$

Where,  $\tau_1$  is the load torque (%),  $I_{t100}$  is the torque current, and  $I_{m100}$  is exciting current.

## 7.2 Selecting a Braking Resistor

### 7.2.1 Selection procedure

The following three requirements must be satisfied simultaneously:

- 1) The maximum braking torque should not exceed values listed in Tables 6.7 to 6.9 in Chapter 6, Section 6.4.1 [1] "Braking resistors." To use the maximum braking torque exceeding values in those tables, select the braking resistor having one class larger capacity.
- 2) The discharge energy for a single braking action should not exceed the discharging capability (kWs) listed in Tables 6.7 to 6.9 in Chapter 6, Section 6.4.1 [1] "Braking resistors." For detailed calculation, refer to Section 7.1.3.3 "Heat energy calculation of braking resistor."
- 3) The average loss that is calculated by dividing the discharge energy by the cyclic period must not exceed the average loss (kW) listed in Tables 6.7 to 6.9 in Chapter 6, Section 6.4.1 [1] "Braking resistors."

### 7.2.2 Notes on selection

The braking time  $T_1$ , cyclic period  $T_0$ , and duty cycle %ED are converted under deceleration braking conditions based on the rated torque as shown below. However, you do not need to consider these values when selecting the braking resistor capacity.

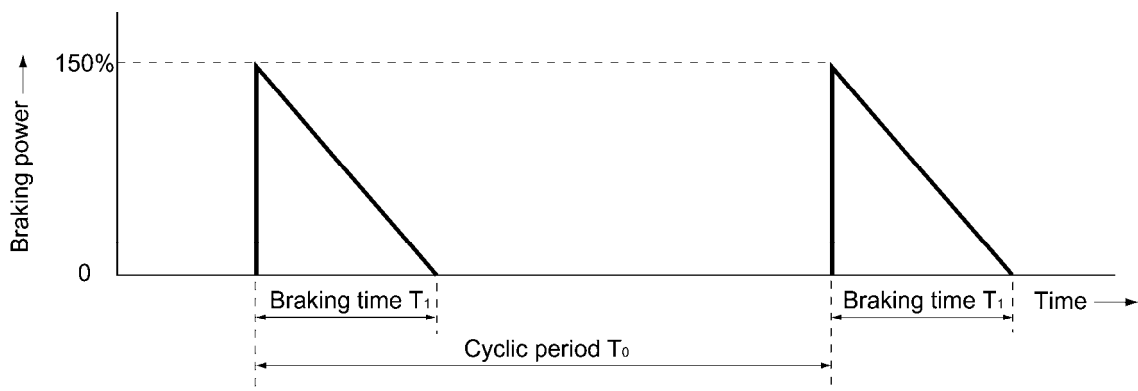

Figure 7.11 Duty Cycle





---

# Chapter 8

## SPECIFICATIONS

This chapter describes specifications of the output ratings, control system, and terminal functions for the FRENIC-Mini series of inverters. It also provides descriptions of the operating and storage environment, external dimensions, examples of basic connection diagrams, and details of the protective functions.

### Contents

8.1	Standard Models .....	8-1
8.1.1	Three-phase 200 V series .....	8-1
8.1.2	Three-phase 400 V series .....	8-2
8.1.3	Single-phase 200 V series .....	8-3
8.1.4	Single-phase 100 V series .....	8-4
8.2	Semi-standard Models.....	8-5
8.2.1	EMC filter built-in type in three-phase 400 V series.....	8-5
8.2.2	EMC filter built-in type in single-phase 200 V series .....	8-6
8.3	Common Specifications .....	8-7
8.4	Terminal Specifications.....	8-11
8.4.1	Terminal functions .....	8-11
8.4.2	Location of terminal blocks.....	8-19
8.4.3	Terminal arrangement diagram and screw specifications.....	8-20
8.4.3.1	Main circuit terminals .....	8-20
8.4.3.2	Control circuit terminals.....	8-22
8.5	Operating Environment and Storage Environment .....	8-24
8.5.1	Operating environment.....	8-24
8.5.2	Storage environment .....	8-25
8.5.2.1	Temporary storage.....	8-25
8.5.2.2	Long-term storage .....	8-25
8.6	External Dimensions .....	8-26
8.6.1	Standard models .....	8-26
8.6.2	EMC filter built-in type.....	8-32
8.7	Connection Diagrams.....	8-37
8.7.1	Keypad operation .....	8-37
8.7.2	Operation by external signal inputs.....	8-38
8.8	Details of Protective Functions .....	8-39



## 8.1 Standard Models

### 8.1.1 Three-phase 200 V series

FRN\_ \_ \_ \_C2S-2□, where □ = A or U

Item		Specifications											
Type (FRN_ _ _ _C2S-2□)		0001	0002	0004	0006	0010	0012	0020	0025	0033	0047	0060	
Nominal applied motor (kW) *1 (□ = A)		0.1	0.2	0.4	0.75	1.5	2.2	3.7	5.5	7.5	11	15	
Nominal applied motor (HP) *1 (□ = U)		1/8	1/4	1/2	1	2	3	5	7.5	10	15	20	
Output Ratings	Rated capacity (kVA) *2	0.30	0.57	1.3	2.0	3.5	4.5	7.2	9.5	12	17	22	
	Rated voltage (V) *3	Three-phase, 200 to 240 V (with AVR function)											
	Rated current (A)	0.8 (0.7) *4	1.5 (1.4) *4	3.5 (2.5) *4	5.5 (4.2) *4	9.2 (7.0) *4	12.0 (10.0) *4	19.1 (16.5) *4	25.0 (23.5) *5	33.0 (31.0) *5	47.0 (44.0) *5	60.0 (57.0) *5	
	Overload capability	150% of rated current for 1 min. 150% of rated current for 1 min or 200% of rated current for 0.5 s (for the rated current given in parentheses)							150% of rated current for 1 min or 200% of rated current for 0.5 s				
	Rated frequency (Hz)	50 / 60 Hz											
Input Ratings	Phases, voltage, frequency	Three-phase, 200 to 240 V, 50/60 Hz											
	Voltage and frequency variations	Voltage: +10 to -15% (Interphase voltage unbalance: 2% or less*6), Frequency: +5 to -5%											
	Rated current (A) *7	(w/ DCR)	0.57	0.93	1.6	3.0	5.7	8.3	14.0	21.1	28.8	42.2	57.6
		(w/o DCR)	1.1	1.8	3.1	5.3	9.5	13.2	22.2	31.5	42.7	60.7	80.0
Required power supply capacity (kVA) *8	0.2	0.3	0.6	1.1	2.0	2.9	4.9	7.4	10	15	20		
Braking	Braking torque (%) *9	150		100		50		30		20			
	DC braking	Starting frequency*10: 0.0 to 60.0 Hz, Braking time: 0.0 to 30.0 s, Braking level: 0 to 100%											
	Transistor for braking resistor	--		Built-in									
Applicable safety standards		UL508C, EN61800-5-1: 2007											
Enclosure		IP20 (IEC 60529:1989), UL open type (UL50)											
Cooling method		Natural cooling					Fan cooling						
Mass (kg)		0.6	0.6	0.7	0.8	1.7	1.7	2.5	3.1	3.1	4.5	4.5	
Mass (lbs)		1.3	1.3	1.5	1.8	3.7	3.7	5.5	6.8	6.8	9.8	9.8	

\*1 Fuji 4-pole standard motors.

\*2 Assuming the rated output voltage as 220 V for three-phase 200 V series.

\*3 Output voltages cannot exceed the power supply voltage.

\*4 The load shall be reduced so that the continuous operating current is the rated current in parentheses or less if the carrier frequency is set to 3 kHz or above or the ambient temperature exceeds 40°C (104°F).

\*5 The load shall be reduced so that the continuous operating current is the rated current in parentheses or less if the carrier frequency is set to 4 kHz or above or ambient temperature exceeds 40°C (104°F).

\*6 Interphase voltage unbalance (%) =  $\frac{\text{Max. voltage (V)} - \text{Min. voltage (V)}}{\text{Three - phase average voltage (V)}} \times 67$  (Refer to IEC 61800 - 3 : 2004)

If this value is 2 to 3%, use an optional AC Reactor (ACR).

\*7 Estimated value to apply when the inverter is connected to the power supply of 500 kVA (inverter capacity x 10 when the inverter capacity exceeds 50 kVA) and %X = 5%.

\*8 Obtained when a DC Reactor (DCR) is used.

\*9 Average braking torque when a motor of no load decelerates from 60 Hz. (It varies with the efficiency of the motor.)

\*10 Effective function only in induction motor drive.

**Note:** A box (□) in the above table replaces A or U depending on the shipping destination.

A: Asia, U: USA

## 8.1.2 Three-phase 400 V series

FRN\_ \_ \_ \_C2S-4□, where □ = A, C, E, or U

Item		Specifications									
Type (FRN_ _ _ _C2S-4□)		0002	0004	0005	0007	0011	0013	0018	0024	0030	
Nominal applied motor (kW) *1 (□ = A, C or E)		0.4	0.75	1.5	2.2	3.7(□=A,C) 4.0(□=E)	5.5	7.5	11	15	
Nominal applied motor (HP) *1 (□ = U)		1/2	1	2	3	5	7.5	10	15	20	
Output Ratings	Rated capacity (kVA) *2	1.3	2.3	3.2	4.8	8.0	9.9	13	18	22	
	Rated voltage (V) *3	Three-phase, 380 to 480 V (with AVR function)									
	Rated current (A)	1.8 (1.5) *4	3.1 (2.5) *4	4.3 (3.7) *4	6.3 (5.5) *4	10.5 (9.0) *4	13.0	18.0	24.0	30.0	
	Overload capability	150% of rated current for 1 min. 150% of rated current for 1 min or 200% of rated current for 0.5 s (for the rated current given in parentheses)					150% of rated current for 1 min or 200% of rated current for 0.5 s				
	Rated frequency (Hz)	50 / 60 Hz									
Input Ratings	Phases, voltage, frequency	Three-phase, 380 to 480 V, 50/60 Hz									
	Voltage and frequency variations	Voltage: +10 to -15% (Interphase voltage unbalance: 2 % or less*5), Frequency: +5 to -5%									
	Rated current (A) *6	(w/ DCR)	0.85	1.6	3.0	4.4	7.3	10.6	14.4	21.1	28.8
		(w/o DCR)	1.7	3.1	5.9	8.2	13.0	17.3	23.2	33.0	43.8
Required power supply capacity (kVA) *7	0.6	1.1	2.0	2.9	4.9	7.4	10	15	20		
Braking	Braking torque (%) *8	100		50	30		20				
	DC braking	Starting frequency*9: 0.0 to 60.0 Hz, Braking time: 0.0 to 30.0 s, Braking level: 0 to 100%									
	Transistor for braking resistor	Built-in									
Applicable safety standards		UL508C, EN61800-5-1: 2007									
Enclosure		IP20 (IEC 60529:1989), UL open type (UL50)									
Cooling method		Natural cooling			Fan cooling						
Mass (kg)		1.2	1.3	1.7	1.7	2.5	3.1	3.1	4.5	4.5	
Mass (lbs)		2.6	2.9	3.7	3.7	5.5	6.8	6.8	9.8	9.8	

\*1 Fuji 4-pole standard motors.

\*2 Assuming the rated output voltage as 440 V for three-phase 400 V series.

\*3 Output voltages cannot exceed the power supply voltage.

\*4 The load shall be reduced so that the continuous operating current is the rated current in parentheses or less if the carrier frequency is set to 3 kHz or above or the ambient temperature exceeds 40°C (104°F).

\*5 Interphase voltage unbalance (%) =  $\frac{\text{Max. voltage (V)} - \text{Min. voltage (V)}}{\text{Three - phase average voltage (V)}} \times 67$  (Refer to IEC 61800 - 3 : 2004)

If this value is 2 to 3%, use an optional AC Reactor (ACR).

\*6 Estimated value to apply when the inverter is connected to the power supply of 500 kVA (inverter capacity x 10 when the inverter capacity exceeds 50 kVA) and %X = 5%.

\*7 Obtained when a DC Reactor (DCR) is used.

\*8 Average braking torque when a motor of no load decelerates from 60 Hz. (It varies with the efficiency of the motor.)

\*9 Effective function only in induction motor drive.

**Note:** A box (□) in the above table replaces A, C, E, or U depending on the shipping destination.

A: Asia, C: China, E: EC, U: USA

### 8.1.3 Single-phase 200 V series

FRN\_ \_ \_ \_C2S-7□, where □ = A, C, E, or U

Item		Specifications						
Type (FRN_ _ _ _C2S-7□)		0001	0002	0004	0006	0010	0012	
Nominal applied motor (kW) *1 (□ = A, C or E)		0.1	0.2	0.4	0.75	1.5	2.2	
Nominal applied motor (HP) *1 (□ = U)		1/8	1/4	1/2	1	2	3	
Output Ratings	Rated capacity (kVA) *2	0.30	0.57	1.3	2.0	3.5	4.5	
	Rated voltage (V) *3	Three-phase, 200 to 240 V (with AVR function)						
	Rated current (A) *4	0.8 (0.7)	1.5 (1.4)	3.5 (2.5)	5.5 (4.2)	9.2 (7.0)	12.0 (10.0)	
	Overload capability	150% of rated current for 1 min. 150% of rated current for 1 min or 200% of rated current for 0.5 s (for the rated current given in parentheses)						
	Rated frequency (Hz)	50 / 60 Hz						
Input Ratings	Phases, voltage, frequency	Single-phase, 200 to 240 V, 50/60 Hz						
	Voltage and frequency variations	Voltage: +10 to -10%, Frequency: +5 to -5%						
	Rated current (A) *5	(w/ DCR)	1.1	2.0	3.5	6.4	11.6	17.5
		(w/o DCR)	1.8	3.3	5.4	9.7	16.4	24.0
Required power supply capacity (kVA) *6	0.3	0.4	0.7	1.3	2.4	3.5		
Braking	Braking torque (%) *7	150		100		50	30	
	DC braking	Starting frequency*8: 0.0 to 60.0 Hz, Braking time: 0.0 to 30.0 s, Braking level: 0 to 100%						
	Transistor for braking resistor	--		Built-in				
Applicable safety standards		UL508C, EN61800-5-1: 2007						
Enclosure		IP20 (IEC 60529:1989), UL open type (UL50)						
Cooling method		Natural cooling			Fan cooling			
Mass (kg)		0.6	0.6	0.7	0.9	1.8	2.5	
Mass (lbs)		1.3	1.3	1.5	2.0	4.0	5.5	

\*1 Fuji 4-pole standard motors.

\*2 Assuming the rated output voltage as 220 V.

\*3 Output voltages cannot exceed the power supply voltage.

\*4 The load shall be reduced so that the continuous operating current is the rated current in parentheses or less if the carrier frequency is set to 3 kHz or above or the ambient temperature exceeds 40°C (104°F).

\*5 Estimated value to apply when the inverter is connected to the power supply of 500 kVA (inverter capacity x 10 when the inverter capacity exceeds 50 kVA) and %X = 5%.

\*6 Obtained when a DC Reactor (DCR) is used.

\*7 Average braking torque when a motor of no load decelerates from 60 Hz. (It varies with the efficiency of the motor.)

\*8 Effective function only in induction motor drive.

**Note:** A box (□) in the above table replaces A, C, E, or U depending on the shipping destination.

A: Asia, C: China, E: EC, U: USA

## 8.1.4 Single-phase 100 V series

FRN\_ \_ \_ \_C2S-6□, where □ = U

Item		Specifications				
Type (FRN_ _ _ _C2S-6U)		0001	0002	0003	0005	
Nominal applied motor (HP) *1		1/8	1/4	1/2	1	
Output Ratings	Rated capacity (kVA) *2	0.26	0.53	0.95	1.6	
	Rated voltage (V) *3	Three-phase, 200 to 240 V (with AVR function)				
	Rated current (A)	0.7	1.4	2.5	4.2	
	Overload capability	150% of rated output current for 1 min or 200% of rated current for 0.5 s				
	Rated frequency (Hz)	50 / 60 Hz				
Input Ratings	Phases, voltage, frequency	Single-phase, 100 to 120 V, 50/60 Hz				
	Voltage and frequency variations	Voltage: +10 to -10%, Frequency: +5 to -5%				
	Rated current (A) *4	(w/ DCR)	2.2	3.8	6.4	12.0
		(w/o DCR)	3.6	5.9	9.5	16.0
Required power supply capacity (kVA) *5	0.3	0.5	0.7	1.3		
Braking	Braking torque (%) *6	150		100		
	DC braking	Starting frequency*7: 0.0 to 60.0 Hz, Braking time: 0.0 to 30.0 s, Braking level: 0 to 100%				
	Transistor for braking resistor	--		Built-in		
Applicable safety standards		UL508C				
Enclosure		IP20 (IEC 60529:1989), UL open type (UL50)				
Cooling method		Natural cooling				
Mass (kg)		0.7	0.7	0.8	1.3	
Mass (lbs)		1.5	1.5	1.8	2.9	

\*1 Fuji 4-pole standard motors.

\*2 Assuming the rated output voltage as 220 V.

\*3 Output voltage cannot exceed the twice of power supply voltage.

\*4 Estimated value to apply when the inverter is connected to the power supply of 50 kVA and %X = 5%.

\*5 Obtained when a DC Reactor (DCR) is used.

\*6 Average braking torque when a motor of no load decelerates from 60 Hz. (It varies with the efficiency of the motor.)

\*7 Effective function only in induction motor drive.

**Note:** When driven by 100 VAC, the single-phase 100 V series of inverters limit their shaft output and maximum output torque as listed below. This is to prevent their output voltage from decreasing when load is applied.

	Shaft output (%)	Maximum torque (%)
w/o DC reactor (DCR)	90	150
w/ DC reactor (DCR)	85	120

**Note:** A box (□) in the above table replaces A, C, E, or U depending on the shipping destination.

A: Asia, C: China, E: EC, U: USA

## 8.2 Semi-standard Models

### 8.2.1 EMC filter built-in type in three-phase 400 V series

FRN\_ \_ \_ \_ C2E-4□, where □ = C, E

Item		Specifications									
Type (FRN_ _ _ _ C2E-4□) (□ = C or E)		0002	0004	0005	0007	0011	0013	0018	0024	0030	
Nominal applied motor (kW) *1		0.4	0.75	1.5	2.2	3.7 (□=C) 4.0 (□=E)	5.5	7.5	11	15	
Nominal applied motor (HP) *1		1/2	1	2	3	5	7.5	10	15	20	
Output Ratings	Rated capacity (kVA) *2	1.3	2.3	3.2	4.8	8.0	9.9	13	18	22	
	Rated voltage (V) *3	Three-phase, 380 to 480 V (with AVR function)									
	Rated current (A) *4	1.8 (1.5)	3.1 (2.5)	4.3 (3.7)	6.3 (5.5)	10.5 (9.0)	13.0	18.0	24.0	30.0	
	Overload capability	150% of rated current for 1 min. 150% of rated current for 1 min or 200% of rated current for 0.5 s (for the rated current given in parentheses)					150% of rated current for 1 min or 200% of rated current for 0.5 s				
	Rated frequency (Hz)	50 / 60 Hz									
Input Ratings	Phases, voltage, frequency	Three-phase, 380 to 480 V, 50/60 Hz									
	Voltage and frequency variations	Voltage: +10 to -15% (Interphase voltage unbalance: 2 % or less*5), Frequency: +5 to -5%									
	Rated current (A) *6	(w/ DCR)	0.85	1.6	3.0	4.4	7.3	10.6	14.4	21.1	28.8
		(w/o DCR)	1.7	3.1	5.9	8.2	13.0	17.3	23.2	33.0	43.8
Required power supply capacity (kVA) *7	0.6	1.1	2.0	2.9	4.9	7.4	10	15	20		
Braking	Braking torque (%) *8	100		50	30		20				
	DC braking	Starting frequency*9: 0.0 to 60.0 Hz, Braking time: 0.0 to 30.0 s, Braking level: 0 to 100%									
	Braking transistor	Built-in									
Applicable safety standards		UL508C, EN61800-5-1: 2007									
Applicable EMC standards (EN61800-3:2004 +A1:2012)		Immunity : Second Environment (Industrial) Emission : Category C2					Immunity : Second Environment (Industrial) Emission : Category C3				
Enclosure		IP20 (IEC 60529:1989), UL open type (UL50)									
Cooling method		Natural cooling			Fan cooling						
Mass (kg)		1.5	1.6	3.0	3.1	3.2	4.6	4.6	6.7	6.7	

\*1 Fuji 4-pole standard motors.

\*2 Assuming the rated output voltage as 440 V for three-phase 400 V series.

\*3 Output voltages cannot exceed the power supply voltage.

\*4 The load shall be reduced so that the continuous operating current is the rated current in parentheses or less if the carrier frequency is set to 3 kHz or above or the ambient temperature exceeds 40°C (104°F).

\*5 Interphase voltage unbalance (%) =  $\frac{\text{Max. voltage (V)} - \text{Min. voltage (V)}}{\text{Three - phase average voltage (V)}} \times 67$  (Refer to IEC 61800 - 3 : 2004)

If this value is 2 to 3%, use an optional AC Reactor (ACR).

\*6 Estimated value to apply when the inverter is connected to the power supply of 500 kVA (inverter capacity x 10 when the inverter capacity exceeds 50 kVA) and %X = 5%.

\*7 Obtained when a DC Reactor (DCR) is used.

\*8 Average braking torque when a motor of no load decelerates from 60 Hz. (It varies with the efficiency of the motor.)

\*9 Effective function only in induction motor drive.

**Note:** A box (□) in the above table replaces A, C, E, or U depending on the shipping destination.

C: China, E: EC

## 8.2.2 EMC filter built-in type in single-phase 200 V series

FRN\_ \_ \_ \_C2E-7□, where □ = C, E

Item		Specifications						
Type (FRN_ _ _ _C2E-7□) (□ = C, E)		0001	0002	0004	0006	0010	0012	
Nominal applied motor (kW) *1		0.1	0.2	0.4	0.75	1.5	2.2	
Nominal applied motor (HP) *1		1/8	1/4	1/2	1	2	3	
Output Ratings	Rated capacity (kVA) *2	0.30	0.57	1.3	2.0	3.5	4.5	
	Rated voltage (V) *3	Three-phase, 200 to 240 V (with AVR function)						
	Rated current (A) *4	0.8 (0.7)	1.5 (1.4)	3.5 (2.5)	5.5 (4.2)	9.2 (7.0)	12.0 (10.0)	
	Overload capability	150% of rated current for 1 min. 150% of rated current for 1 min or 200% of rated current for 0.5 s (for the rated current given in parentheses)						
	Rated frequency (Hz)	50 / 60 Hz						
Input Ratings	Phases, voltage, frequency	Single-phase, 200 to 240 V, 50/60 Hz						
	Voltage and frequency variations	Voltage: +10 to -10%, Frequency: +5 to -5%						
	Rated current (A) *5	(w/ DCR)	1.1	2.0	3.5	6.4	11.6	17.5
		(w/o DCR)	1.8	3.3	5.4	9.7	16.4	24.0
Required power supply capacity (kVA) *6	0.3	0.4	0.7	1.3	2.4	3.5		
Braking	Braking torque (%) *7	150		100		50	30	
	DC braking	Starting frequency*8: 0.0 to 60.0 Hz, Braking time: 0.0 to 30.0 s, Braking level: 0 to 100%						
	Transistor for braking resistor	--		Built-in				
Applicable safety standards		UL508C, EN61800-5-1: 2007						
Applicable EMC standards (EN61800-3:2004 +A1:2012)		Immunity : Second Environment (Industrial) Emission : Category C2						
Enclosure		IP20 (IEC 60529:1989), UL open type (UL50)						
Cooling method		Natural cooling			Fan cooling			
Mass (kg)		0.7	0.7	0.8	1.2	3.0	3.0	

\*1 Fuji 4-pole standard motors.

\*2 Assuming the rated output voltage as 220 V.

\*3 Output voltages cannot exceed the power supply voltage.

\*4 The load shall be reduced so that the continuous operating current is the rated current in parentheses or less if the carrier frequency is set to 3 kHz or above or the ambient temperature exceeds 40°C (104°F).

\*5 Obtained when a DC Reactor (DCR) is used.

\*6 Average braking torque when a motor of no load decelerates from 60 Hz. (It varies with the efficiency of the motor.)

\*7 Estimated value to apply when the inverter is connected to the power supply of 500 kVA (inverter capacity x 10 when the inverter capacity exceeds 50 kVA) and %X = 5%.

\*8 Effective function only in induction motor drive.

**Note:** A box (□) in the above table replaces A, C, E, or U depending on the shipping destination.

C: China, E: EC



## 8.3 Common Specifications

Item		Explanation					
Output frequency	Setting range	Maximum frequency	25.0 to 400.0 Hz variable				
		Base frequency	25.0 to 400.0 Hz variable				
		Starting frequency	0.1 to 60.0 Hz variable				
		Carrier frequency	0.75 to 16 kHz variable <b>Note:</b> To protect the inverter, when the carrier frequency is 6 kHz or more, the carrier frequency automatically lowers depending upon the ambient temperature or output current states. (The automatic lowering function can be disabled.) *1				
Output frequency accuracy (Stability)	<ul style="list-style-type: none"> <li>Analog setting: <math>\pm 2\%</math> of max freq. (at 25°C), temperature drift: <math>\pm 0.2\%</math> of max freq. (at 25±10°C)</li> <li>Keypad setting: <math>\pm 0.01\%</math> of max freq. (at 25°C), temperature drift: <math>\pm 0.01\%</math> of max freq. (at 25±10°C)</li> </ul>						
	Frequency setting resolution						
	<ul style="list-style-type: none"> <li>Analog setting: 1/1000 of maximum frequency</li> <li>Keypad setting: 0.01 Hz (99.99 Hz or less), 0.1 Hz (100.0 to 400.0 Hz)</li> <li>Link setting: 1/20000 of maximum frequency or 0.01 Hz (fixed)</li> </ul>						
Control	Control system		Driving induction motor (IM) <ul style="list-style-type: none"> <li>V/f control, slip compensation, auto torque boost</li> <li>Dynamic torque vector control, automatic energy saving control</li> </ul> Driving permanent magnet synchronous motor (PMSM) (without speed / position sensor) *2 <ul style="list-style-type: none"> <li>Speed control range: 10% or more of the base frequency</li> </ul>				
	Voltage/frequency characteristics		<table border="1"> <tr> <td>200 V class series</td> <td> <ul style="list-style-type: none"> <li>Possible to set output voltage at base frequency and at maximum output frequency (80 to 240 V).</li> <li>The AVR control *1 can be turned ON or OFF.</li> <li>Non-linear V/f *1 setting (2 points): Free voltage (0 to 240 V) and frequency (0 to 400 Hz) can be set.</li> </ul> </td> </tr> <tr> <td>400 V class series</td> <td> <ul style="list-style-type: none"> <li>Possible to set output voltage at base frequency and at maximum output frequency (160 to 500 V).</li> <li>The AVR control *1 can be turned ON or OFF.</li> <li>Non-linear V/f *1 setting (2 points): Free voltage (0 to 500 V) and frequency (0 to 400 Hz) can be set.</li> </ul> </td> </tr> </table>	200 V class series	<ul style="list-style-type: none"> <li>Possible to set output voltage at base frequency and at maximum output frequency (80 to 240 V).</li> <li>The AVR control *1 can be turned ON or OFF.</li> <li>Non-linear V/f *1 setting (2 points): Free voltage (0 to 240 V) and frequency (0 to 400 Hz) can be set.</li> </ul>	400 V class series	<ul style="list-style-type: none"> <li>Possible to set output voltage at base frequency and at maximum output frequency (160 to 500 V).</li> <li>The AVR control *1 can be turned ON or OFF.</li> <li>Non-linear V/f *1 setting (2 points): Free voltage (0 to 500 V) and frequency (0 to 400 Hz) can be set.</li> </ul>
	200 V class series	<ul style="list-style-type: none"> <li>Possible to set output voltage at base frequency and at maximum output frequency (80 to 240 V).</li> <li>The AVR control *1 can be turned ON or OFF.</li> <li>Non-linear V/f *1 setting (2 points): Free voltage (0 to 240 V) and frequency (0 to 400 Hz) can be set.</li> </ul>					
	400 V class series	<ul style="list-style-type: none"> <li>Possible to set output voltage at base frequency and at maximum output frequency (160 to 500 V).</li> <li>The AVR control *1 can be turned ON or OFF.</li> <li>Non-linear V/f *1 setting (2 points): Free voltage (0 to 500 V) and frequency (0 to 400 Hz) can be set.</li> </ul>					
Torque boost *1		<ul style="list-style-type: none"> <li>Auto torque boost (For constant torque load)</li> <li>Manual torque boost : Torque boost value can be set between 0.0 and 20.0%.</li> <li>Select application load with the function code. (For variable torque load or constant torque load)</li> </ul>					
Starting torque *1		<ul style="list-style-type: none"> <li>150% or more (Running at 3 Hz, with auto torque boost active)</li> </ul>					
Start/stop operation		Keypad: Start and stop with RUN and STOP keys (standard keypad/optional remote keypad) External signals (digital inputs): Run forward and stop command, Run reverse and stop command, coast-to-stop command, etc. Link operation: Operation through RS-485 (built-in as standard)					

\*1 Available only for induction motor drive.

\*2 Not supported by the first version.

Item	Explanation	
Control	Frequency setting	Keypad operation using the $\odot$ and $\ominus$ keys (with data protection function). Also can be set with function code (only via communication) and be copied. *2
	Built-in potentiometer	Analog input: 0 to $\pm 10$ V DC / 0 to 100% (terminal [12]), 4 to 20 mA / 0 to 100%, 0 to 20 mA / 0 to 100% (terminal [C1])
	Multistep frequency:	Selectable from 16 different frequencies (step 0 to 15)
	UP/DOWN operation:	Frequency can be increased or decreased while the digital input signal is ON.
	Link operation:	Frequency can be specified through RS-485 communications link.
	Frequency setting switching:	Two types of frequency settings can be switched with an external signal (digital input). Switchable to frequency settings given through the communications link or multistep frequency setting.
	Auxiliary frequency setting:	Each of inputs from the built-in potentiometer and terminal [12]/[C1] can be added to the main setting as auxiliary frequency settings.
	Inverse operation:	Switchable from "0 to +10 VDC/0 to 100%" to "+10 to 0 VDC/0 to 100%" by external signals. Switchable from "4 to 20 mA DC (0 to 20 mA DC)/0 to 100%" to "20 to 4 mA DC (20 to 0 mA DC)/0 to 100%" by external signals.
	Acceleration/ deceleration time	<ul style="list-style-type: none"> <li>Setting range: 0.00 to 3600 s, variable</li> <li>The two types of acceleration/deceleration time settings can be made or selected individually (switchable during running).</li> <li>Acceleration/deceleration pattern: Acceleration and deceleration pattern can be selected from 4 types: Linear, S-curve (weak), S-curve (strong), and Curvilinear (maximum acceleration/deceleration capacity of constant output).</li> <li>Shutoff of a run command causes the motor to coast to a stop.</li> <li>The acceleration/deceleration time for jogging can be set. (Setting range: 0.00 to 3600 s)</li> </ul>
	Frequency limiter (Upper/lower)	Upper and lower limiters can be set. (Setting range: 0 to 400 Hz)
Bias frequency	Bias of set frequency and PID command can be set in the range between 0 and $\pm 100\%$ .	
Gain for frequency setting	The analog input gain can be set in the range from 0 to 200%.	
Jump frequency setting	Three operation points and their common jump hysteresis width (0 to 30 Hz) can be set. Six operation points and their common jump hysteresis width (0 to 30 Hz) can be set. *2	
Timer operation	Operate and stop by the time set with keypad. (1 cycle operation)	
Jogging operation *1	Jogging operation is possible by RUN key ( Standard keypad ) or digital input. (ACC./DEC. time for Jogging operation can be set. (ACC. and DEC. time is common.)	

\*1 Available only for induction motor drive.

\*2 Available in the ROM version 0500 or later.

Item	Explanation
Restart after momentary power failure *1	<ul style="list-style-type: none"> <li>• Trip at power failure: The inverter trips immediately after power failure.</li> <li>• Trip at power recovery: Coast-to-stop at power failure and trip at power recovery</li> <li>• Deceleration stop: Deceleration stop at power failure, and trip after stoppage. *2</li> <li>• Start at the frequency selected before momentary stop: Coast-to-stop at power failure and start after power recovery at the frequency selected before momentary stop.</li> <li>• Start at starting frequency: Coast-to-stop at power failure and start at the starting frequency after power recovery.</li> </ul>
Current limit *1 (Hardware current limiting)	Hardware current limiting is used avoiding over current tripping of the inverter, when impact load change or momentary power failure that can be responded software current limiting. (Hardware current limiting can be inactive.)
Slip compensation *1	<ul style="list-style-type: none"> <li>• Compensate the lowering the motor speed and get the stabilized operation.</li> </ul>
Current limiter	<ul style="list-style-type: none"> <li>• Control output current so that output current is preset limiting value or less.</li> </ul>
PID control	PID control for process control is possible. <ul style="list-style-type: none"> <li>• PID command: Keypad, Analog input (Terminal 12,C1), RS-485 communications</li> <li>• Feed back value: Analog input (Terminal 12,C1)</li> <li>• Accessory functions</li> </ul> Stop for Slow flow rate function, Normal operation/inverse operation Integration reset/hold
Automatic deceleration	<ul style="list-style-type: none"> <li>• If the calculated torque exceeds automatic deceleration level, the inverter avoids overvoltage trip by automatically controlling the frequency. *1</li> <li>• If the DC link bus voltage exceeds the overvoltage limitation level during deceleration, the inverter automatically prolongs the deceleration time to three times to avoid overvoltage trip.</li> </ul>
Deceleration characteristics	Make the motor loss increase during deceleration so as to reduce the regenerative energy from motor and avoid Overvoltage trip.
Auto-energy saving operation *1	Control the output voltage so as to minimize the sum of motor loss and inverter loss at constant speed.
Active drive	The output frequency is automatically reduced to suppress the overload protection trip of the inverter caused by an increase in the IGBT junction temperature or the ambient temperature, motor load or the like.
Off-line tuning *1	Tunes $r1$ , $X\sigma$ , and no-load current. Tunes $r1$ , $X\sigma$ , no-load current, and slip frequency. *2
Cooling fan ON/OFF control	Detects inverter internal temperature and stops cooling fan when the temperature is low.
Second motor parameters	<ul style="list-style-type: none"> <li>• A single inverter can drive two motors by switching. Only induction motor can be set as second motor. The function data set for second motor are base frequency, rated current, torque boost, Electronic overload protection for motor, slip compensation, etc.</li> <li>• Second motor parameters can be preset in the inverter. Auto-tuning is possible.</li> </ul>
Limiting the direction of the motor rotation	Reverse rotation inhibited/Forward rotation inhibited selectable.

\*1 Available only for induction motor drive.

\*2 Available in the ROM version 0500 or later.

Item	Explanation	
During running/stop	Speed monitor, output current (A), output voltage (V), input power (kW), PID command value, PID feedback value, PID output, timer (s) and input watt-hour (kWh). ◆ Select the speed monitor to be displayed from the following: Output frequency (before slip compensation) (Hz), output frequency (after slip compensation) (Hz), reference frequency (Hz), load shaft speed (min <sup>-1</sup> ), line speed (m/min), constant feeding rate time (min). * Speed monitor can display the speed specified with E48.	
Life early warning	The life early warning of the main circuit capacitors, capacitors on the PC boards and the cooling fan can be displayed.	
Cumulative run hours	The cumulative motor running hours, cumulative inverter running hours and cumulative watt-hours can be displayed.	
I/O checking	Indicate the status of the Di, Do on the control circuit.	
Energy saving monitor	Input power, Input power × coefficient are indicated.	
Display	When tripped Displays the cause of trip by codes as follows. <ul style="list-style-type: none"> <li>• <i>OL1</i> (Overcurrent during acceleration)</li> <li>• <i>OL2</i> (Overcurrent during deceleration)</li> <li>• <i>OL3</i> (Overcurrent at constant speed)</li> <li>• <i>L1</i> (Input phase loss)</li> <li>• <i>UV</i> (Undervoltage)</li> <li>• <i>OP</i> (Output phase loss)</li> <li>• <i>OU1</i> (Overvoltage during acceleration)</li> <li>• <i>OU2</i> (Overvoltage during deceleration)</li> <li>• <i>OU3</i> (Overvoltage during constant speed)</li> <li>• <i>OH1</i> (Overheating of the heat sink)</li> <li>• <i>OH2</i> (External thermal relay tripped)</li> <li>• <i>OH4</i> (Motor protection (PTC thermistor))</li> <li>• <i>OR</i> (Braking resistor overheat)</li> <li>• <i>OF</i> (PID feedback wire break)</li> </ul>	<ul style="list-style-type: none"> <li>• <i>OL1</i> (Motor overload)</li> <li>• <i>OL2</i> (Motor 2 overload)</li> <li>• <i>OU</i> (Inverter unit overload)</li> <li>• <i>Er1</i> (Memory error)</li> <li>• <i>Er2</i> (Keypad communications error)</li> <li>• <i>Er3</i> (CPU error)</li> <li>• <i>Er5</i> (Operation procedure error)</li> <li>• <i>Er7</i> (Tuning error)</li> <li>• <i>Er8</i> (RS-485 error)</li> <li>• <i>ErF</i> (Data save error due to undervoltage)</li> <li>• <i>Err</i> (Mock alarm)</li> <li>• <i>Er-d</i> (Step-out detection (for drive of permanent magnet synchronous motors))</li> </ul>
	During running or when tripped	Trip history: The causes (codes) of the last four trips are saved and displayed. The detailed running status data of the last four trips are also saved and displayed.
Protection	Refer to Section 8.8 "Details of Protective Functions."	
Environment	Refer to Section 8.5 "Operating Environment and Storage Environment."	

## 8.4 Terminal Specifications

### 8.4.1 Terminal functions

#### Main circuit and analog input terminals

Classification	Symbol	Name	Functions	Related function codes
Main circuit	L1/R, L2/S, L3/T	Main circuit power input	Connects a three-phase power supply. (three-phase 200 V, 400 V series)	
	L1/L, □, L2/N		Connects a single-phase power supply. □ indicates no connection terminal. (Single-phase 200 V series)	
	U, V, W	Inverter output	Connects a three-phase induction motor.	
	P1, P(+)	For DC reactor	Connects a DC reactor.	
	P(+), N(-)	DC link bus	Connects a DC power device.	
	P(+), DB	For braking resistor	Used for connection of an optional external braking resistor. (No function for inverters of 0.2 kW or less)	
	 G	Grounding	Grounding terminal for inverter chassis (Two terminals are provided.)	
Analog input	[13]	Potentiometer power supply	Power supply (+10 VDC) for frequency command potentiometer (Potentiometer: 1 to 5 kΩ) Allowable maximum output current: 10 mA	
	[12]	Voltage input	The frequency is set according to the external analog input voltage.	F18, C32 to C34
		(Normal operation)	0 to +10 VDC/0 to 100% 0 to +5 VDC/0 to 100% or +1 to +5 VDC/0 to 100% can be selected by function code setting.	
		(Inverse operation)	+10 to 0 VDC/0 to 100% (switchable by digital input signal)	
		(PID control)	Used for reference signal (PID process command) or PID feedback signal.	E61
(Frequency auxiliary setting)	Used as additional auxiliary setting to various frequency settings.	E61		
Electric characteristics of terminal [12]				
<ul style="list-style-type: none"> <li>• Input impedance: 22 kΩ</li> <li>• Allowable maximum input voltage: 15 VDC (If the input voltage exceeds +10 VDC, the inverter regards it as +10 VDC.)</li> </ul>				
[C1]	Current input	The frequency is set according to the external analog input current command.	F18, C37 to C40	
	(Normal operation)	+4 to +20 mADC/0 to 100%, 0 to +20 mADC/0 to 100% ("+4 to +20 mADC" and "0 to +20 mADC" are switchable with function code C40.)		
	(Inverse operation)	+20 to +4 mADC/0 to 100%, +20 to 0 mADC/0 to 100% (Normal and inverse operations are switchable with digital input signal <i>IVS</i> .)		
(Under PID control)	Used for reference signal (PID process command) or PID feedback signal.	E62		

Classification	Symbol	Name	Functions	Related function codes
Analog input	[C1]	(For PTC thermistor)	<p>Connects a PTC thermistor for motor protection. (Connect a 1 kΩ external resistor to terminal [13] - [C1].)</p>	H26, H27
		(Frequency auxiliary setting)	Used as additional auxiliary setting to various frequency settings.	E62
			<p>Electric characteristics of terminal [C1]</p> <ul style="list-style-type: none"> <li>• Input impedance: 250Ω</li> <li>• Allowable maximum input current: +30 mADC (If the input current exceeds +20 mADC, the inverter regards it as +20 mADC.)</li> </ul>	
	[11]	Analog common	Common for analog input signals ([13], [12], [C1]) (Isolated from terminals [CM] and [Y1E].)	

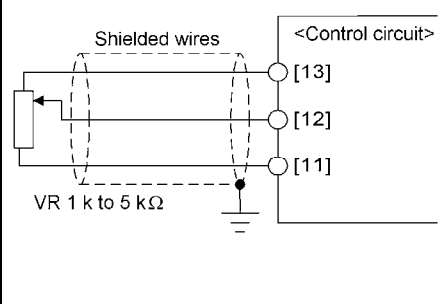
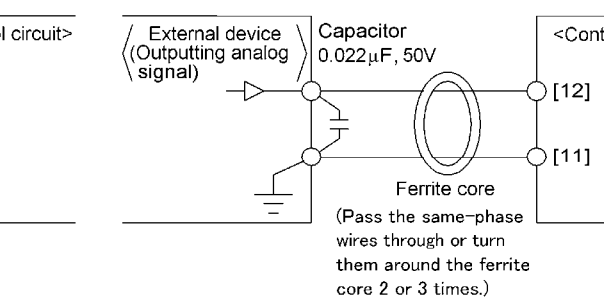
Classification	Symbol	Name	Functions	Related function codes
Analog input	<p><b>Note</b></p> <ul style="list-style-type: none"> <li>• Since weak analog signals are handled, these signals are especially susceptible to the external noise effects. Route the wiring as short as possible (within 20 m) and use shielded wires. In principle, ground the shielding layer of the shielded wires; if effects of external inductive noises are considerable, connection to terminal [11] may be effective. As shown in Figure 8.1, ground the single end of the shield to enhance the shielding effect.</li> <li>• Use a twin contact relay for weak signals if the relay is used in the control circuit. Do not connect the relay's contact to terminal [11].</li> <li>• When the inverter is connected to an external device outputting the analog signal, a malfunction may be caused by electric noise generated by the inverter. If this happens, according to the circumstances, connect a ferrite core (a toroidal core or an equivalent) to the device outputting the analog signal and/or connect a capacitor having the good cut-off characteristics for high frequency between control signal wires as shown in Figure 8.2.</li> <li>• Do not apply a voltage of +7.5 VDC or higher to terminal [C1]. Doing so could damage the internal control circuit.</li> </ul>			
				
		<p>Figure 8.1 Connection of Shielded Wire</p>	<p>Figure 8.2 Example of Electric Noise Prevention</p>	

## Digital input terminals

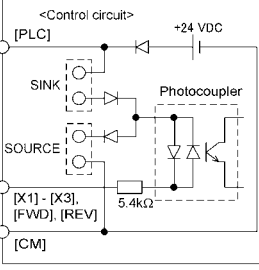
Classification	Symbol	Name	Functions	Related function codes																							
Digital input	[X1]	Digital input 1	<p>Possible to assign various signals to terminals [X1] to [X3], [FWD] and [REV] using function codes. For details, refer to Section 9.2.2 "E codes."</p> <p>By factory default, <b>FWD</b> and <b>REV</b> signals are assigned to terminals [FWD] and [REV], respectively.</p> <p>Common features</p> <ul style="list-style-type: none"> <li>Sink/Source switching feature: Sink and source can be switched by using the built-in jumper switch.</li> <li>Normal/negative logic input switching feature: Switches the logic value (1/0) for ON/OFF of terminals between [X1] to [X3], [FWD] or [REV], and [CM]. If the logic value for ON between [X1] and [CM] is 1 in the normal logic system, for example, OFF is 1 in the negative logic system.</li> </ul> <p>Digital input circuit specifications</p>  <table border="1" data-bbox="970 853 1283 1122"> <thead> <tr> <th>Item</th> <th>Min.</th> <th>Max.</th> </tr> </thead> <tbody> <tr> <td rowspan="2">Operation voltage (SINK)</td> <td>ON level</td> <td>0V</td> <td>2V</td> </tr> <tr> <td>OFF level</td> <td>22V</td> <td>27V</td> </tr> <tr> <td rowspan="2">Operation voltage (SOURCE)</td> <td>ON level</td> <td>22V</td> <td>27V</td> </tr> <tr> <td>OFF level</td> <td>0V</td> <td>2V</td> </tr> <tr> <td>Operation current at ON (Input voltage at 0 V)</td> <td>2.5mA</td> <td>5mA</td> </tr> <tr> <td>Allowable leakage current at OFF</td> <td>-</td> <td>0.5mA</td> </tr> </tbody> </table>	Item	Min.	Max.	Operation voltage (SINK)	ON level	0V	2V	OFF level	22V	27V	Operation voltage (SOURCE)	ON level	22V	27V	OFF level	0V	2V	Operation current at ON (Input voltage at 0 V)	2.5mA	5mA	Allowable leakage current at OFF	-	0.5mA	E01 to E03
	Item	Min.		Max.																							
	Operation voltage (SINK)	ON level		0V	2V																						
		OFF level		22V	27V																						
	Operation voltage (SOURCE)	ON level		22V	27V																						
OFF level		0V	2V																								
Operation current at ON (Input voltage at 0 V)	2.5mA	5mA																									
Allowable leakage current at OFF	-	0.5mA																									
	[X2]	Digital input 2																									
	[X3]	Digital input 3																									
	[FWD]	Forward operation command		E98, E99																							
	[REV]	Reverse operation command																									
	[PLC]	PLC signal power	Connects to PLC output signal power supply. (Rated voltage: +24 VDC, Maximum output current: 50 mA)																								
	[CM]	Digital common	Common for digital input signals (Isolated from terminals [11] and [Y1E].)																								



Classification	Symbol	Name	Functions	Related function codes
Digital input	<p><b>Tip</b></p>	<p>■ <b>Turning ON or OFF [X1], [X2], [X3], [FWD], or [REV] using a relay contact</b></p> <p>Figure 8.3 shows two examples of a circuit that turns ON or OFF control signal input [X1], [X2], [X3], [FWD], or [REV] using a relay contact. Circuit (a) has a connecting jumper applied to SINK, whereas circuit (b) has it applied to SOURCE.</p> <p>NOTE: To configure this kind of circuit, use a highly reliable relay (Recommended product: Fuji control relay Model HH54PW.)</p>		
		<p>Figure 8.3 Circuit Configuration Using a Relay Contact</p> <p>■ <b>Turning ON or OFF [X1], [X2], [X3], [FWD], or [REV] using a programmable logic controller (PLC)</b></p> <p>Figure 8.4 shows two examples of a circuit that turns ON or OFF control signal input [X1], [X2], [X3], [FWD], or [REV] using a programmable logic controller (PLC). Circuit (a) has a connecting jumper applied to SINK, whereas circuit (b) has it applied to SOURCE.</p> <p>In circuit (a) below, short-circuiting or opening the transistor's open collector circuit in the PLC using an external power source turns ON or OFF control signal [X1], [X2], [X3], [FWD], or [REV]. When using this type of circuit, observe the following:</p> <ul style="list-style-type: none"> <li>• Connect the + node of the external power source (which should be isolated from the PLC's power) to terminal [PLC] of the inverter.</li> <li>• Do not connect terminal [CM] of the inverter to the common terminal of the PLC.</li> </ul>		<p>Figure 8.4 Circuit Configuration Using a PLC</p> <p>For details about the jumper setting, refer to the FRENIC-Mini Instruction Manual, Chapter 2, Section 2.3.7 "Setting up the slide switches."</p>

## Analog output, transistor output, and relay output terminals

Classification	Symbol	Name	Functions	Related function codes														
Analog output	[FMA]	Analog monitor	<p>The monitor signal for analog DC voltage (0 to +10 VDC) is output. The signal functions can be selected with the function code F31 from the following.</p> <ul style="list-style-type: none"> <li>• Output frequency (before slip compensation)</li> <li>• Output frequency (after slip compensation)</li> <li>• Output current</li> <li>• Output voltage</li> <li>• Input power</li> <li>• PID feedback value</li> <li>• DC link bus voltage</li> <li>• Analog output test (+)</li> <li>• PID command (SV)</li> <li>• PID output (MV)</li> </ul> <p>(Output voltage: 0 to +10 VDC, maximum current: 2 mA Up to two analog voltmeters can be connected.)</p>	F30, F31														
	[11]	Analog common	<p>Common for analog output signal ([FMA])</p> <p>This terminal is electrically isolated from terminals [CM] and [Y1E].</p>															
Transistor output	[Y1]	Transistor output	<p>Possible to assign various signals to terminals [Y1] using function code E20. For details, refer to Section 9.2.2 "E codes."</p> <p>Normal/negative logic output switching feature: Switches the logic value (1/0) for ON/OFF of the terminals between [Y1] and [Y1E]. If the logic value for ON between [Y1] and [Y1E] is 1 in the normal logic system, for example, OFF is 1 in the negative logic system.</p> <p>Digital output circuit specification</p> <table border="1"> <thead> <tr> <th colspan="2">Item</th> <th>Max.</th> </tr> </thead> <tbody> <tr> <td rowspan="2">Operation voltage</td> <td>ON level</td> <td>2V</td> </tr> <tr> <td>OFF level</td> <td>27V</td> </tr> <tr> <td colspan="2">Maximum load current at ON</td> <td>50mA</td> </tr> <tr> <td colspan="2">Leakage current at OFF</td> <td>0.1mA</td> </tr> </tbody> </table>	Item		Max.	Operation voltage	ON level	2V	OFF level	27V	Maximum load current at ON		50mA	Leakage current at OFF		0.1mA	E20
	Item		Max.															
Operation voltage	ON level	2V																
	OFF level	27V																
Maximum load current at ON		50mA																
Leakage current at OFF		0.1mA																
	[Y1E]	Transistor output common	<p>Common for transistor output signal (Isolated from terminals [CM] and [11].)</p>															



- Note**
- Check the polarity of an external power input.
  - To connect a control relay, connect a surge absorbing diode across the coil of the relay.

Classification	Symbol	Name	Functions	Related function codes
Transistor output	<p><b>Tip</b> ■ <b>Connecting Programmable Controller (PLC) to Terminal [Y1]</b></p> <p>Figure 8.5 shows two examples of circuit connection between the transistor output of the inverter's control circuit and a PLC. In example (a), the input circuit of the PLC serves as the sink for the control circuit, whereas in example (b), it serves as the source for the control circuit.</p>		<p>(a) PLC serving as Sink</p> <p>(b) PLC serving as Source</p>	
	Relay output	<p>[30A], [30B], [30C]</p>	<p>Alarm relay output (for any fault)</p>	<p>(1) Outputs a contact signal (SPDT) when a protective function is activated to stop the motor. Contact rating: 250 VAC 0.3A <math>\cos\phi = 0.3</math> +48 VDC, 0.5A</p> <p>(2) Possible to select a command similar to terminal [Y1] for transistor output signal and use it for signal output.</p> <p>(3) The normal/negative logic output changeover is applicable to these contact outputs: "Terminals [30A] and [30C] are short-circuited for ON signal output" or "terminals [30B] and [30C] are short-circuited (non-excite) for ON signal output"</p>

Figure 8.5 Connecting PLC to Control Circuit

## RS-485 communications port

Classification	Connector	Name	Functions	Related function codes
Communication	RS-485 communications port (RJ-45)	RS-485 communications I/O	<p>(1) Used to connect the inverter with PC or PLC using RS-485 port.</p> <p>(2) Used to connect the inverter with the remote keypad. The inverter supplies the power to the remote keypad through the extension cable.</p> <p>RJ-45 connector is used.</p> <p>For the transmission specifications, refer to Chapter 5, Section 5.1 "Overview on RS-485 Communication."</p>	H30, y01 to y10, y99



- Route the wiring of the control terminals as far from the wiring of the main circuit as possible. Otherwise electric noise may cause malfunctions.
- Fix the control circuit wires inside the inverter to keep them away from the live parts of the main circuit (such as the terminal block of the main circuit).

### 8.4.2 Location of terminal blocks

The terminal blocks are located as shown below. The location differs according to the inverter type.

 For details about terminal arrangement, refer to Section 8.4.3, "Terminal arrangement diagram and screw specifications."

Power supply voltage	Applicable motor rating (kW)	Inverter type	Refer to:
Three-phase 200 V	0.1	FRN0001C2S-2□	Figure A
	0.2	FRN0002C2S-2□	
	0.4	FRN0004C2S-2□	
	0.75	FRN0006C2S-2□	
	1.5	FRN0010C2S-2□	Figure B
	2.2	FRN0012C2S-2□	
	3.7	FRN0020C2S-2□	
	5.5	FRN0025C2S-2□	Figure C
	7.5	FRN0033C2S-2□	
	11	FRN0047C2S-2□	
15	FRN0060C2S-2□		
Three-phase 400 V	0.4	FRN0002C2■-4□	Figure B
	0.75	FRN0004C2■-4□	
	1.5	FRN0005C2■-4□	
	2.2	FRN0007C2■-4□	
	3.7/4.0	FRN0011C2■-4□	Figure C
	5.5	FRN0013C2■-4□	
	7.5	FRN0018C2■-4□	
	11	FRN0024C2■-4□	
15	FRN0030C2■-4□		
Single-phase 200 V	0.1	FRN0001C2■-7□	Figure A
	0.2	FRN0002C2■-7□	
	0.4	FRN0004C2■-7□	
	0.75	FRN0006C2S-7□	Figure B
	0.75	FRN0006C2E-7□	
	1.5	FRN0010C2■-7□	
	2.2	FRN0012C2■-7□	
Single-phase 100 V	0.1	FRN0001C2S-6U	Figure A
	0.2	FRN0002C2S-6U	
	0.4	FRN0003C2S-6U	
	0.75	FRN0005C2S-6U	Figure B

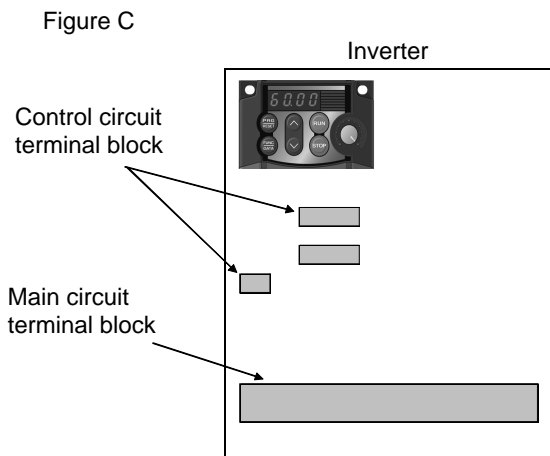
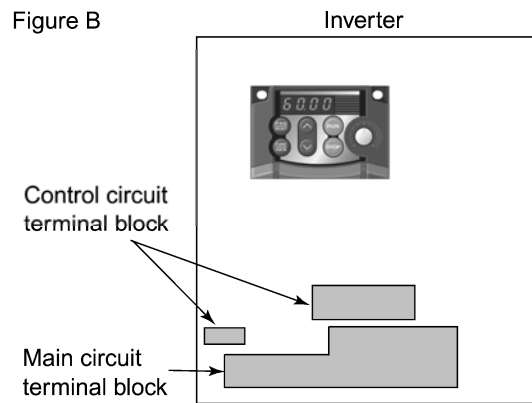
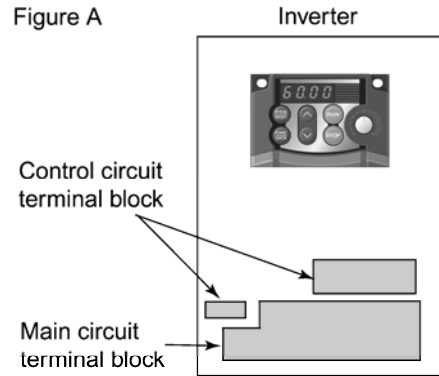

Notes: 1) A box (□) in the above table replaces A, C, E, or U depending on the shipping destination.

2) A box (■) in the above tables replaces S (Basic type) or E (EMC filter built-in type) depending on the enclosure.

## 8.4.3 Terminal arrangement diagram and screw specifications

### 8.4.3.1 Main circuit terminals

The table below shows the main circuit terminal arrangements, screw sizes, and tightening torque. Note that the terminal arrangements differ according to the inverter types. Two terminals designed for grounding shown as the symbol,  in Figures A to D make no distinction between a power supply source (a primary circuit) and a motor (a secondary circuit).

Table 8.1 Main Circuit Terminal Arrangements, Screw Sizes, and Tightening Torque  
(0.1 kW to 3.7 kW class (1/8 HP to 5 HP class))

Power supply voltage	Applicable motor rating kW (HP)	Inverter type	Refer to:	Figure A
Three-phase 200 V	0.1 (1/8)	FRN0001C2S-2□	Figure A	
	0.2 (1/4)	FRN0002C2S-2□		
	0.4 (1/2)	FRN0004C2S-2□		
	0.75 (1)	FRN0006C2S-2□		
	1.5 (2)	FRN0010C2S-2□		
	2.2 (3)	FRN0012C2S-2□		
Three-phase 400 V	0.4 (1/2)	FRN0002C2■-4□	Figure B	
	0.75 (1)	FRN0004C2■-4□		
	1.5 (2)	FRN0005C2■-4□		
	2.2 (3)	FRN0007C2■-4□		
	3.7/4.0 (5)	FRN0011C2■-4□		
Single-phase 200 V	0.1 (1/8)	FRN0001C2■-7□	Figure C	
	0.2 (1/4)	FRN0002C2■-7□		
	0.4 (1/2)	FRN0004C2■-7□		
	0.75 (1)	FRN0006C2■-7□		
	1.5 (2)	FRN0010C2■-7□		
Single-phase 100 V	0.1 (1/8)	FRN0001C2S-6U	Figure D	
	0.2 (1/4)	FRN0002C2S-6U		
	0.4 (1/2)	FRN0003C2S-6U		
	0.75 (1)	FRN0005C2S-6U		

Notes: 1) A box (□) in the above table replaces A, C, E, or U depending on the shipping destination.

2) A box (■) in the above tables replaces S (Basic type) or E (EMC filter built-in type) depending on the enclosure.

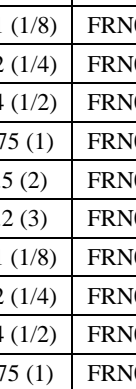
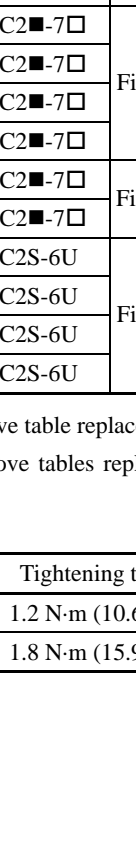
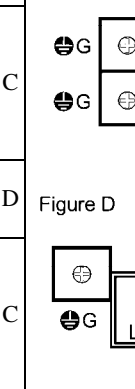
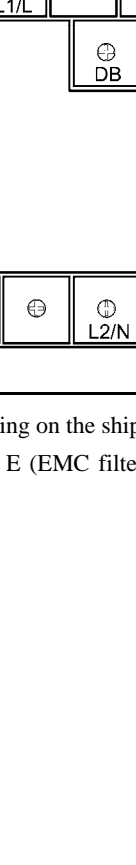
Screw size	Tightening torque
M3.5	1.2 N·m (10.6 lb-in)
M4.0	1.8 N·m (15.9 lb-in)

Table 8.2 Main Circuit Terminal Arrangements, Screw Sizes, and Tightening Torque (5.5 kW to 15 kW class (7.5 HP to 20 HP class))

Power supply voltage	Applicable motor rating kW (HP)	Inverter type	Refer to:
Three-phase 200 V	5.5 (7.5)	FRN0025C2S-2□	Figure E
	7.5 (10)	FRN0033C2S-2□	
	11 (15)	FRN0047C2S-2□	Figure F
	15 (20)	FRN0060C2S-2□	
Three-phase 400 V	5.5 (7.5)	FRN0013C2S-4□	Figure E
	7.5 (10)	FRN0018C2S-4□	
	11 (15)	FRN0024C2S-4□	Figure F
	15 (20)	FRN0030C2S-4□	
	5.5 (7.5)	FRN0013C2E-4□	Figure G
	7.5 (10)	FRN0018C2E-4□	
	11 (15)	FRN0024C2E-4□	Figure H
15 (20)	FRN0030C2E-4□		

Screw size	Tightening torque
M4	1.8 N·m (15.9 lb-in)
M5	3.0 N·m (26.6 lb-in)
M6	5.8 N·m (51.3 lb-in)

**Figure E**

**Figure F**

**Figure G**

**Figure H**

Notes: 1) A box (□) in the above table replaces A, C, E, or U depending on the shipping destination.

2) A box (■) in the above tables replaces S (Basic type) or E (EMC filter built-in type) depending on the enclosure.

### 8.4.3.2 Control circuit terminals

The diagram and table below show the control circuit terminal arrangement, screw sizes, and tightening torque. They are the same in all FRENIC-Mini models.

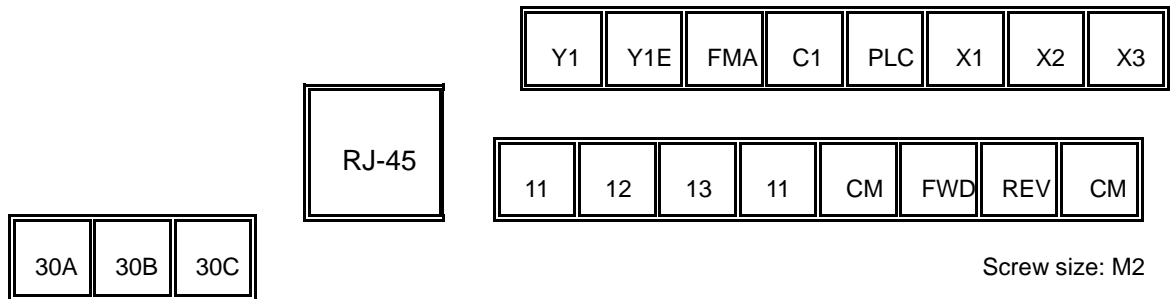

Screw size: M2.5

Figure A: 0.1 kW to 3.7 kW (1/8 HP to 5 HP)

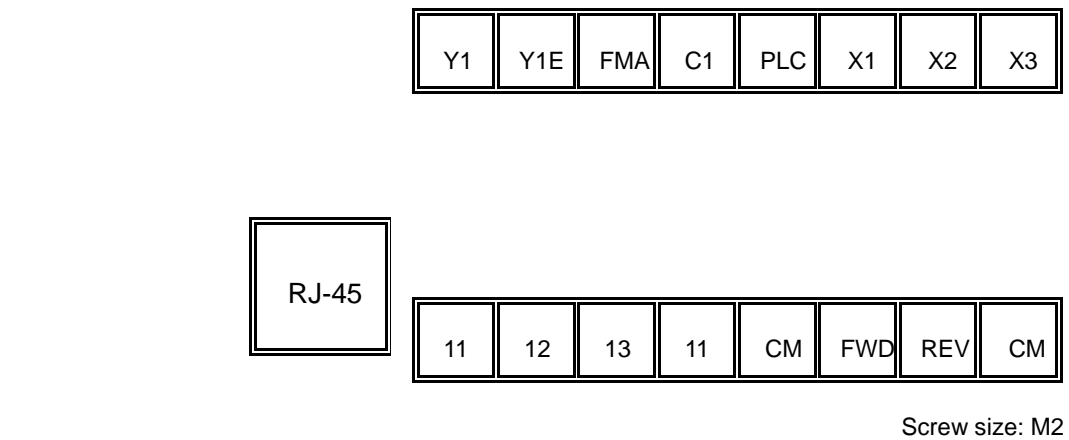

Screw size: M2.5

Figure B: 5.5 kW to 15 kW (7.5 HP to 20 HP)

Screw size	Tightening torque
M2.0	0.2 N·m (1.8 lb-in)
M2.5	0.4 N·m (3.5 lb-in)

Terminal symbol	Screwdriver (Shape of tip, B x A)  Thickness of tip: B	Allowable wire size	Bared wire length  l	Ferrule terminal (see the table below) Opening dimension in the terminal block  W, H
[30A], [30B], [30C]	Flat screwdriver (0.6 x 3.5 mm) (0.02 x 0.14 inch)	AWG22 to AWG18 (0.34 to 0.75 mm <sup>2</sup> )	6 to 7 mm (0.24 to 0.28 inch)	2.8 (W) x 1.7 (H) mm (0.11 (W) x 0.07(H) inch)
Other than those above	Flat screwdriver (0.5 x 2.4 mm) (0.02 x 0.09 inch)	AWG24 to AWG18 (0.25 to 0.75 mm <sup>2</sup> )	5 to 6 mm (0.2 to 0.24 inch)	1.7 (W) x 1.4 (H) mm (0.07 (W) x 0.06 (H) inch)



## Recommended ferrule terminals

Manufacturer: WAGO.

Screw size	Wire size	Type (216-□□□)			
		w/ isolation collar		w/o isolation collar	
		Short type	Long type	Short type	Long type
M2	AWG24 (0.25 mm <sup>2</sup> )	321	301	151	131
	AWG22 (0.34 mm <sup>2</sup> )	322	302	152	132
	AWG20 (0.50 mm <sup>2</sup> )	221	201	121	101
	AWG18 (0.75 mm <sup>2</sup> )	222	202	122	102

The wire strip length to be inserted into a ferrule terminal is 5.0 mm (0.20 inch) for the short type and 8.0 mm (0.31 inch) for the long type. The recommended crimping tool is Variocrimp 4, Model No. 206-204.

## 8.5 Operating Environment and Storage Environment

### 8.5.1 Operating environment

The operating environment for FRENIC-Mini shows below.

Item	Specifications	Careful site for installation	
Ambient temperature *1	-10 to +50°C (14 to 122°F)	Places around heating machines like furnace, constant temperature bath, or boiler Enclosed cases or rooms Tropical region or outdoor machinery Cold room or cold region	
Relative humidity	5 to 95% (No condensation)	Inside of dryer machines for brewing, food or wood processing Transportation equipment for frozen food Inside of tunnel Places where there is much ice and snow Places where water or steam is used	
Atmosphere *2	Dust	Clean	Foundry, cement plant, spinning mill, fertilizer mill, flouring mill, iron factory, timber mill, construction site, the places around grinder
	Salinity	Little (0.01 mg/cm <sup>2</sup> or less per year)	Places like coast or shipping that is susceptible to sea salt
	Oil mist	None	Places where oil like grinding fluid gets mist
	Flammable gas Corrosive gas	None	Chemical factory, oil refinery, fuel gas facility, gas station, water treatment plant, hot spring region, geothermal power station, colliery
Altitude *3	1000 m (3300 ft) or lower	Mountainous region, heights	
Atmospheric pressure	86-106 kPa	—	
Vibration	3 mm : 2 to less than 9 Hz (Max. amplitude) 9.8 m/s <sup>2</sup> : 9 to less than 20 Hz 2.0 m/s <sup>2</sup> : 20 to less than 55 Hz 1.0 m/s <sup>2</sup> : 55 to less than 200 Hz	Vehicle, shipping, machinery	

\*1 The inverter must not be subjected to sudden changes in temperature that will cause condensation to form.

\*2 Do not install the inverter in an environment where it may be exposed to cotton waste or moist dust or dirt which will clog the heat sink in the inverter. If the inverter is to be used in such an environment, install it in the control board of your system or other dustproof containers.

\*3 If you use the inverter in an altitude above 1000 m (3300 ft), you should apply a reduction factor of withstand voltage test and an output current derating factor as listed below when selecting the inverter properly.

Altitude	Reduction factor of withstand voltage test	Output current derating factor
1000 m or lower (3300 ft or lower)	1.00	1.00
1000 – 1500 m (3300 – 4900 ft)	0.95	0.97
1500 – 2000 m (4900 – 6600 ft)	0.90	0.95
2000 – 2500 m (6600 – 8200 ft)	0.85	0.91
2500 – 3000 m (8200 – 9800 ft)	0.80	0.88

## 8.5.2 Storage environment

### 8.5.2.1 Temporary storage

Store the inverter in an environment that satisfies the requirements listed below.

Item	Specifications	
Storage temperature <sup>*1</sup>	-25 to +70°C (-13 to 158°F)	Places not subjected to abrupt temperature changes or condensation or freezing
Relative humidity	5 to 95% <sup>*2</sup>	
Atmosphere	The inverter must not be exposed to dust, direct sunlight, corrosive or flammable gases, oil mist, vapor, water drops or vibration. The atmosphere must contain only a low level of salt. (0.01 mg/cm <sup>2</sup> or less per year)	
Atmospheric pressure	86-106 kPa (during storage)	
	86-106 kPa (during transportation)	

\*1 Assuming a comparatively short time storage, e.g., during transportation or the like.

\*2 Even if the humidity is within the specified requirements, avoid such places where the inverter will be subjected to sudden changes in temperature that will cause condensation to form.

#### Precautions for temporary storage

- (1) Do not leave the inverter directly on the floor.
- (2) If the environment does not satisfy the specified requirements, wrap the inverter in an airtight vinyl sheet or the like for storage.
- (3) If the inverter is to be stored in high-humidity environment, put a drying agent (such as silica gel) in the airtight package described in item (2).

### 8.5.2.2 Long-term storage

The long-term storage method of the inverter varies largely according to the environment of the storage site. General storage methods are described below.

- (1) The storage site must satisfy the requirements specified for temporary storage. However, for storage exceeding three months, the ambient temperature range should be within the range from -10 to 30°C (14 to 86°F). This is to prevent electrolytic capacitors in the inverter from deterioration.
- (2) The package must be airtight to protect the inverter from moisture. Add a drying agent inside the package to maintain the relative humidity inside the package within 70%.
- (3) If the inverter has been installed to the equipment or control board at construction sites where it may be subjected to humidity, dust or dirt, then remove the inverter and store it in a preferable environment.

#### Precautions for storage over 1 year

If the inverter has not been powered on for a long time, the property of the electrolytic capacitors may deteriorate. Power the inverters on once a year and keep the inverters powering on for 30 to 60 minutes. Do not connect the inverters to motors or run the motor.

## 8.6 External Dimensions

The diagrams below show external dimensions of FRENIC-Mini according to the inverter type.

### 8.6.1 Standard models

Figure A

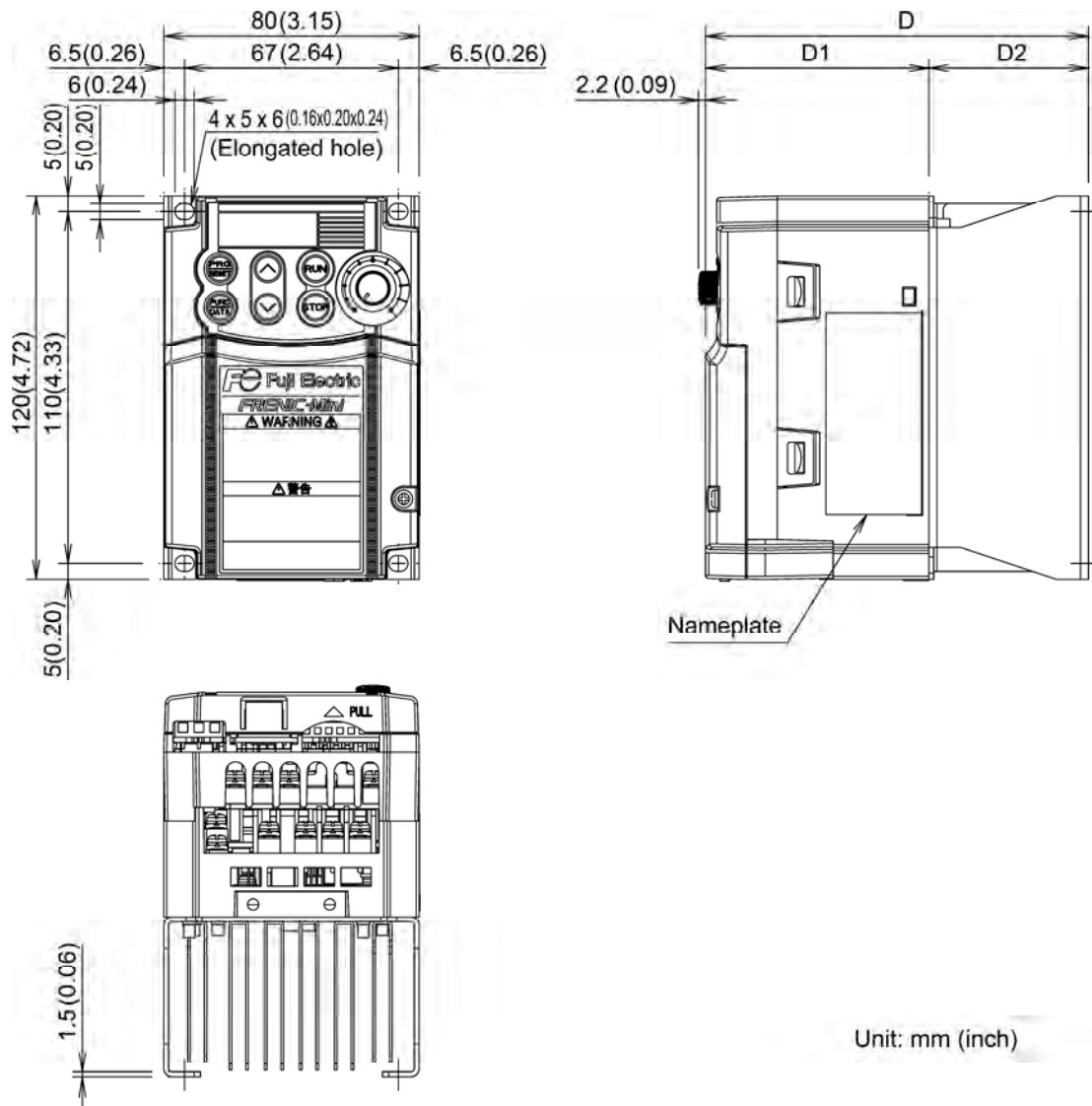

Power supply voltage	Inverter type	Dimensions mm (inch)		
		D	D1	D2
Three-phase 200 V	FRN0001C2S-2□	80 (3.15)	70 (2.76)	10 (0.39)
	FRN0002C2S-2□			25 (0.98)
	FRN0004C2S-2□	95 (3.74)		50 (1.97)
	FRN0006C2S-2□	120 (4.72)		
Single-phase 200 V	FRN0001C2S-7□	80 (3.15)	90 (3.54)	10 (0.39)
	FRN0002C2S-7□	95 (3.74)		25 (0.98)
	FRN0004C2S-7□	140 (5.51)	90 (3.54)	50 (1.97)
	FRN0006C2S-7□			
Single-phase 100 V	FRN0001C2S-6U	100 (3.94)	90 (3.54)	10 (0.39)
	FRN0002C2S-6U	115 (4.53)		25 (0.98)
	FRN0003C2S-6U			

Note: A box (□) in the above table replaces A, C, E, or U depending on the shipping destination.

Figure B

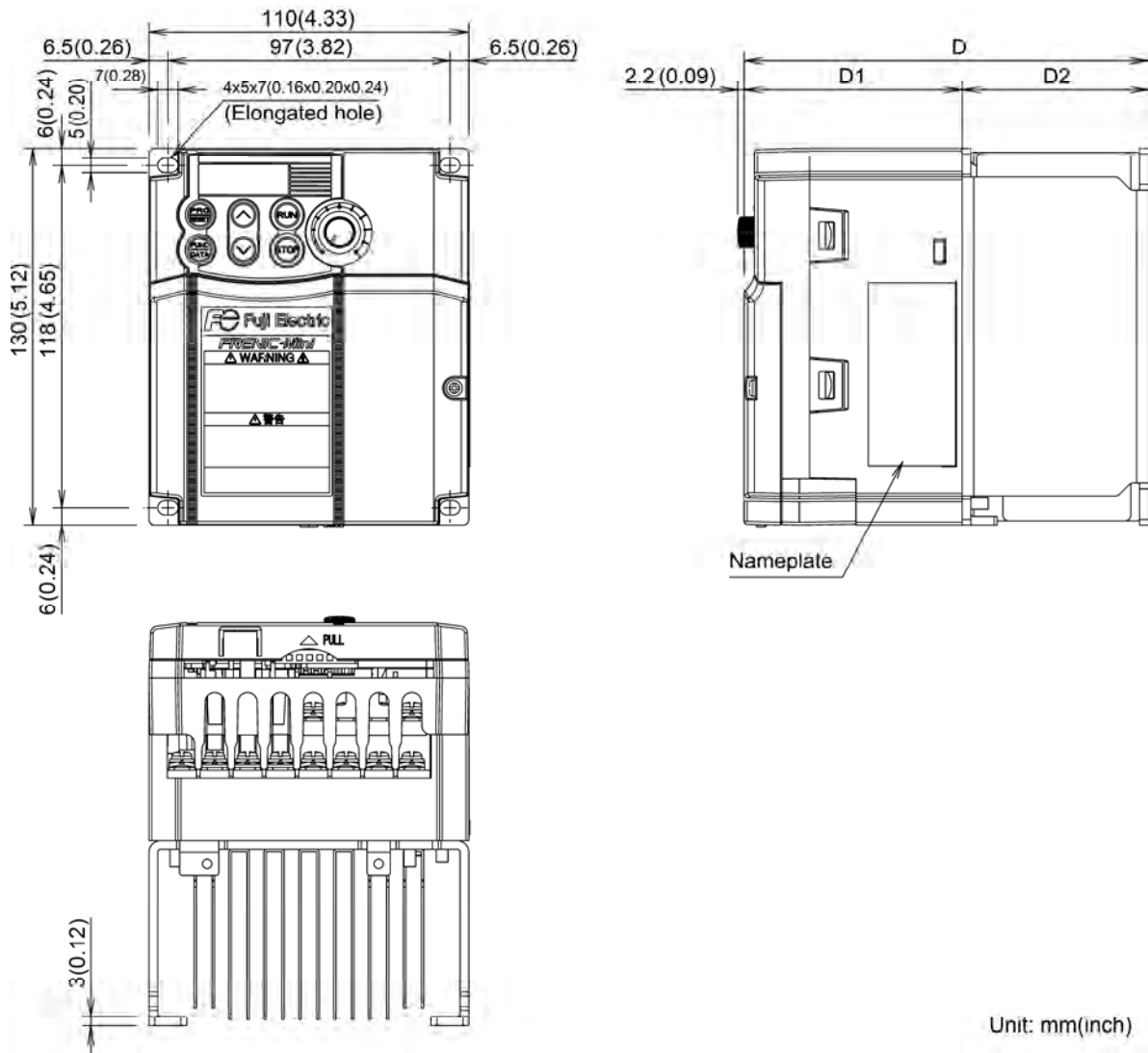

Power supply voltage	Inverter type	Dimensions mm (inch)		
		D	D1	D2
Three-phase 400 V	FRN0002C2S-4□	115 (4.53)	75 (2.95)	40 (1.57)
	FRN0004C2S-4□	139 (5.47)		64 (2.52)
Single-phase 100 V	FRN0005C2S-6U	139 (5.47)	99 (3.90)	40 (1.57)

Note: A box (□) in the above table replaces A, C, E, or U depending on the shipping destination.

Figure C

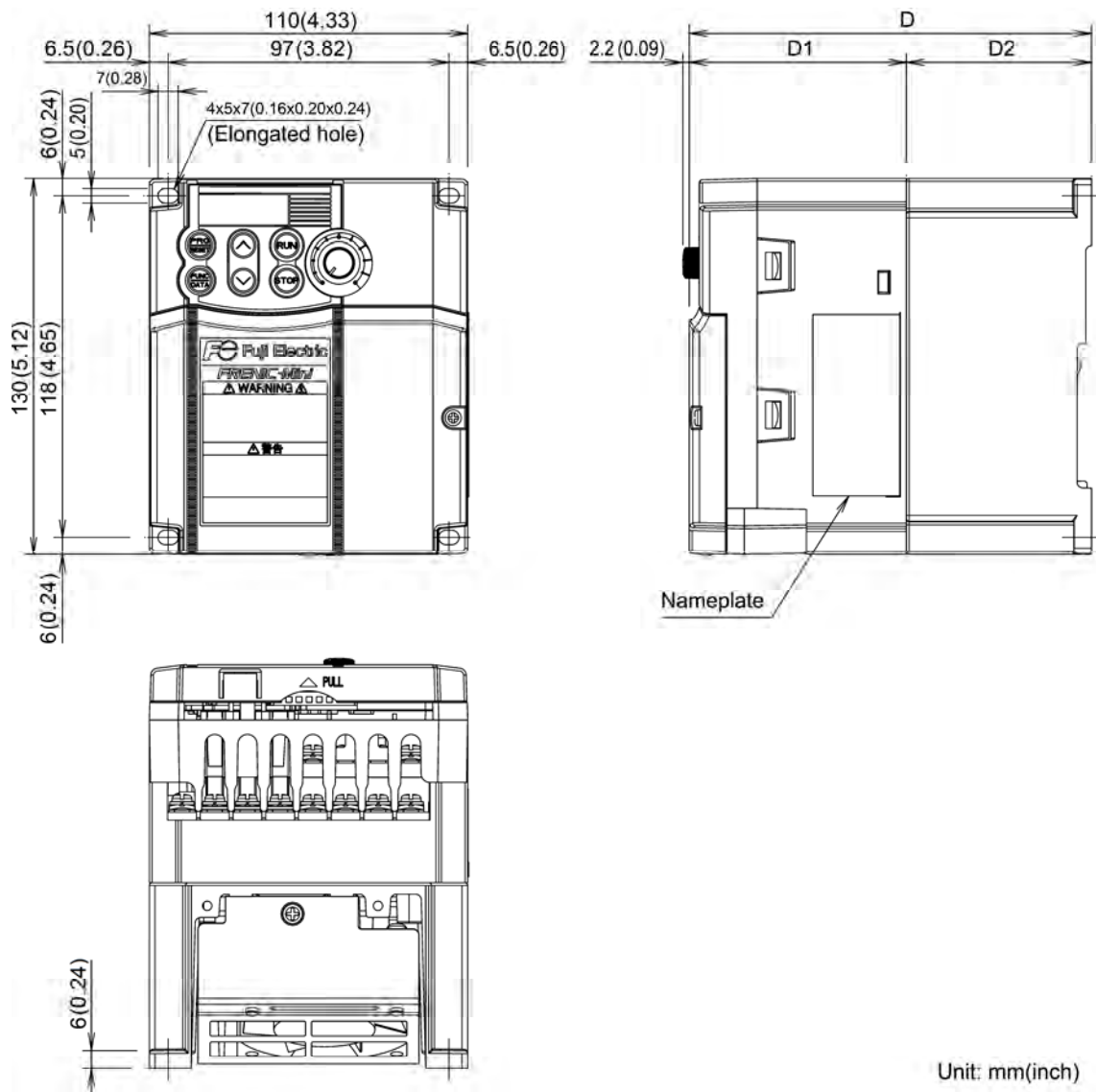

Unit: mm(inch)

Power supply voltage	Inverter type	Dimensions mm (inch)		
		D	D1	D2
Three-phase 200 V	FRN0010C2S-2□	139 (5.47)	75 (2.95)	64 (2.52)
	FRN0012C2S-2□			
Three-phase 400 V	FRN0005C2S-4□			
	FRN0007C2S-4□			
Single-phase 200 V	FRN0010C2S-7□	149 (5.87)	85 (3.35)	

Note: A box (□) in the above table replaces A, C, E, or U depending on the shipping destination.

Figure D

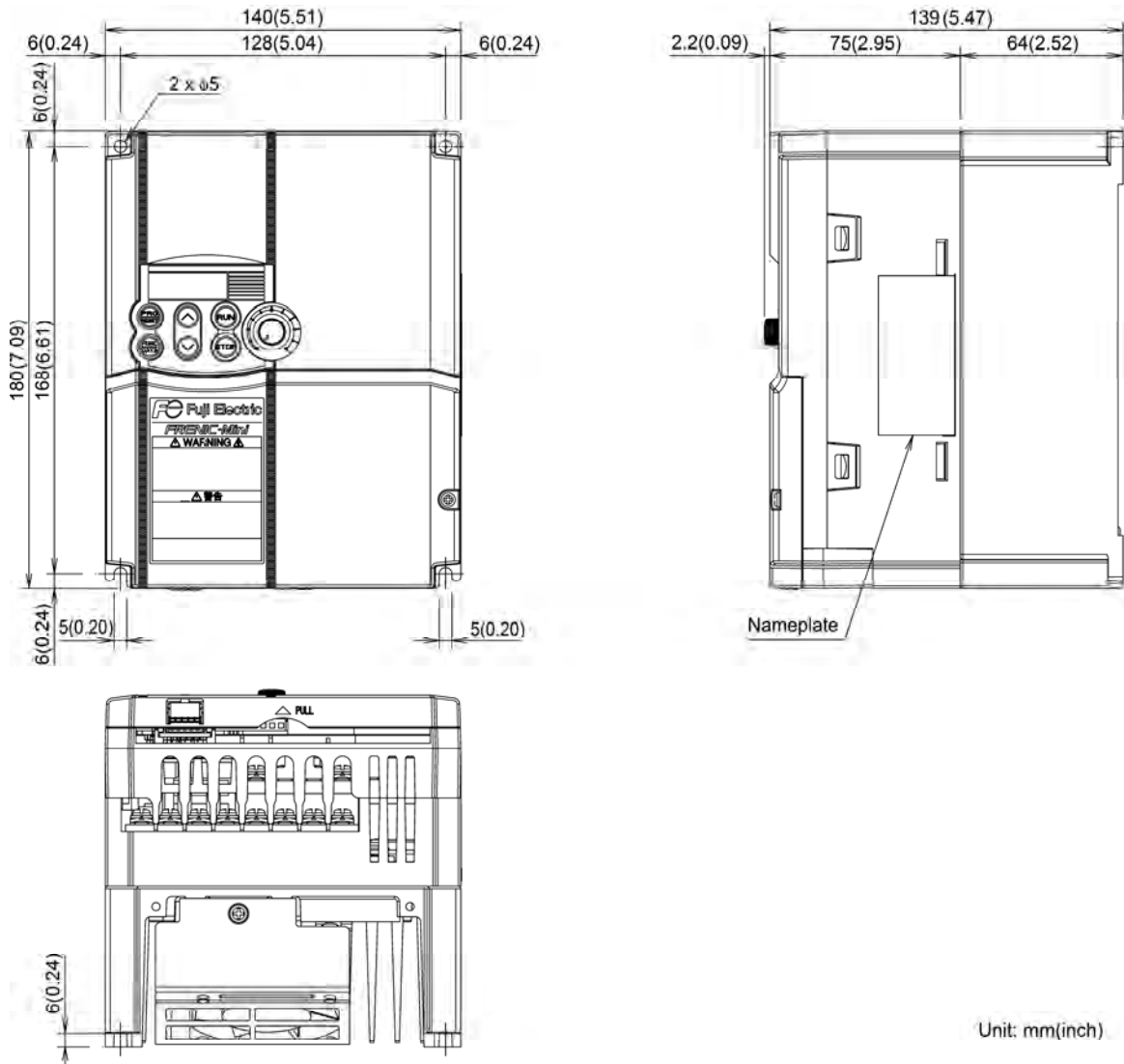

Unit: mm(inch)

Power supply voltage	Inverter type
Three-phase 200 V	FRN0020C2S-2□
Three-phase 400 V	FRN0011C2S-4□
Single-phase 200 V	FRN0012C2S-7□

Note: A box (□) in the above table replaces A, C, E, or U depending on the shipping destination.

Figure E

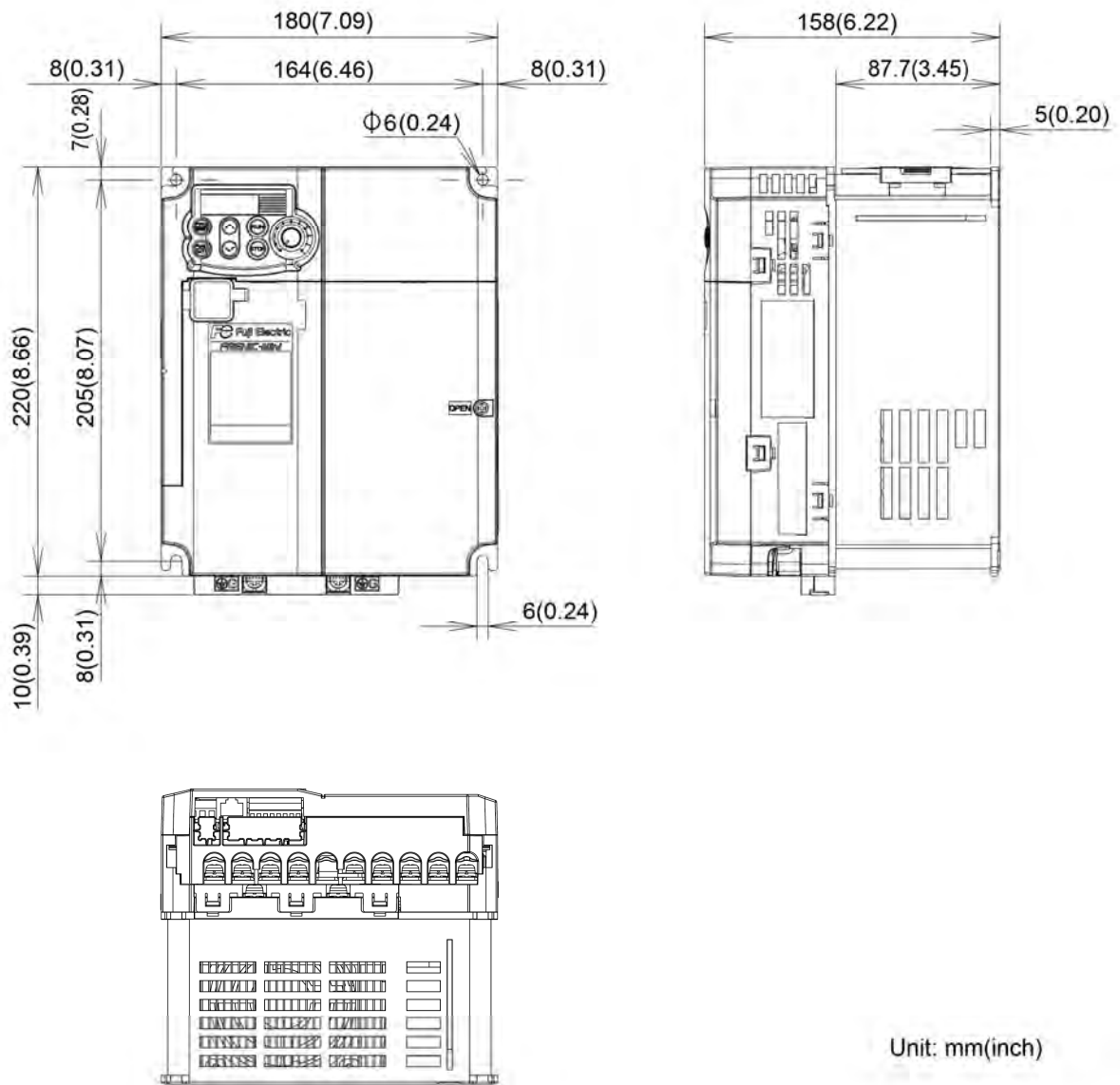

Unit: mm(inch)

Power supply voltage	Inverter type
Three-phase 200 V	FRN0025C2S-2□
	FRN0033C2S-2□
Three-phase 400 V	FRN0013C2S-4□
	FRN0018C2S-4□

Note: A box (□) in the above table replaces A, C, E, or U depending on the shipping destination.



Figure F

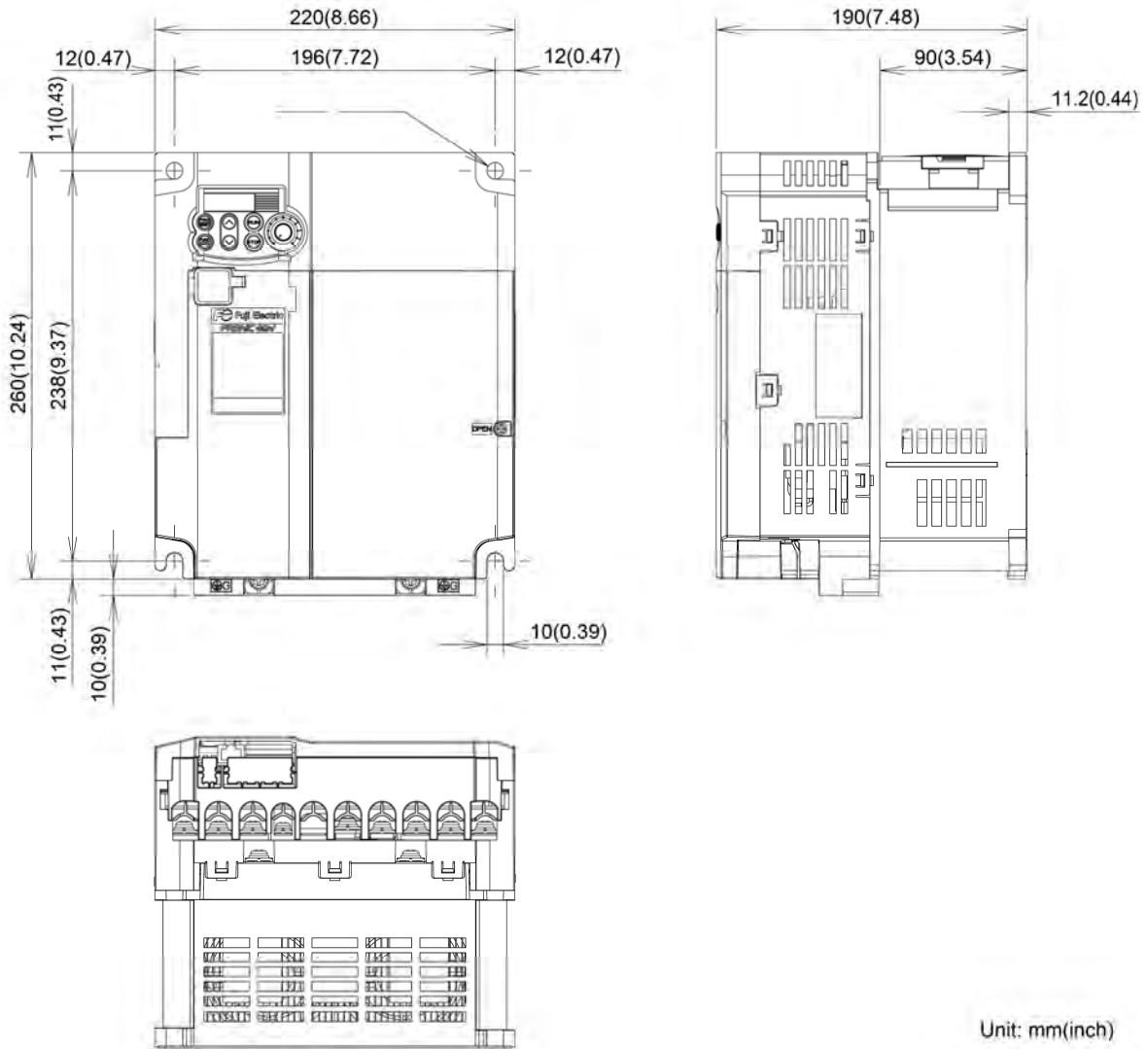

Power supply voltage	Inverter type
Three-phase 200 V	FRN0047C2S-2□
	FRN0060C2S-2□
Three-phase 400 V	FRN0024C2S-4□
	FRN0030C2S-4□

Note: A box (□) in the above table replaces A, C, E, or U depending on the shipping destination.

## 8.6.2 EMC filter built-in type

Figure A

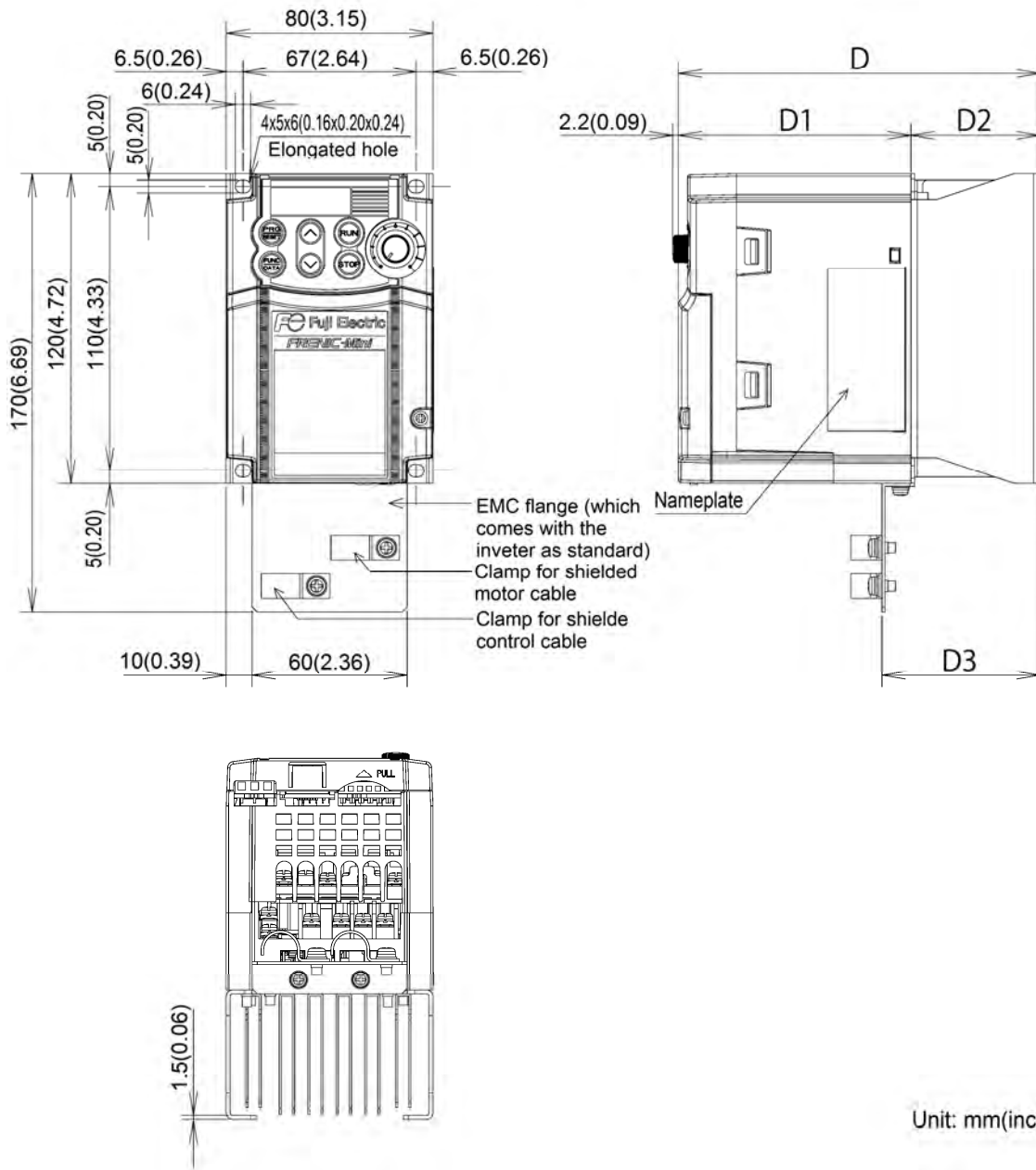

Power supply voltage	Inverter type	Dimensions mm (inch)			
		D	D1	D2	D3
Single-phase 200 V	FRN0001C2E-7□	100 (3.93)	90 (3.54)	10 (0.39)	21.2 (0.83)
	FRN0002C2E-7□			25 (0.98)	36.2 (1.43)
	FRN0004C2E-7□	115 (4.53)			

Note: A box (□) in the above table replaces A, C, E, or U depending on the shipping destination.

Figure B

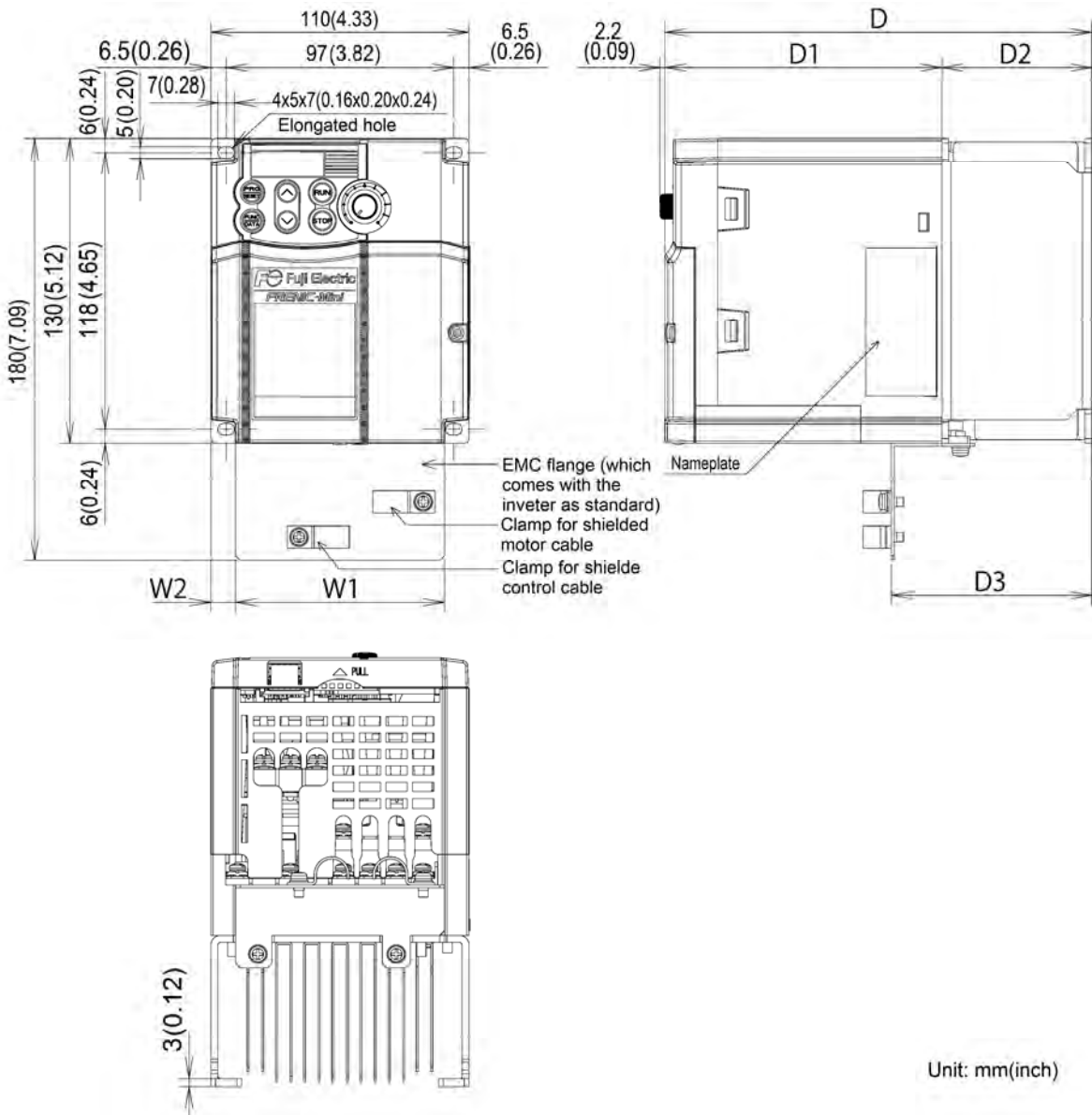

Power supply voltage	Inverter type	Dimensions mm (inch)					
		W1	W2	D	D1	D2	D3
Three-phase 400 V	FRN0002C2E-4□	89 (3.50)	10.5 (0.41)	158 (6.22)	118 (4.65)	40 (1.57)	61.5 (2.42)
	FRN0004C2E-4□			182 (7.17)		64 (2.52)	85.5 (3.37)
Single-phase 200 V	FRN0006C2E-7□	60 (2.36)	13.0 (0.51)	139 (5.47)	99 (3.90)	40 (1.57)	55.2 (2.17)

Note: A box (□) in the above table replaces A, C, E, or U depending on the shipping destination.

Figure C

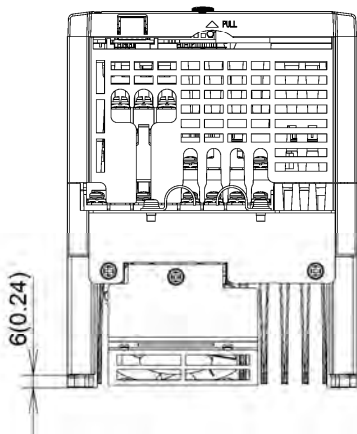
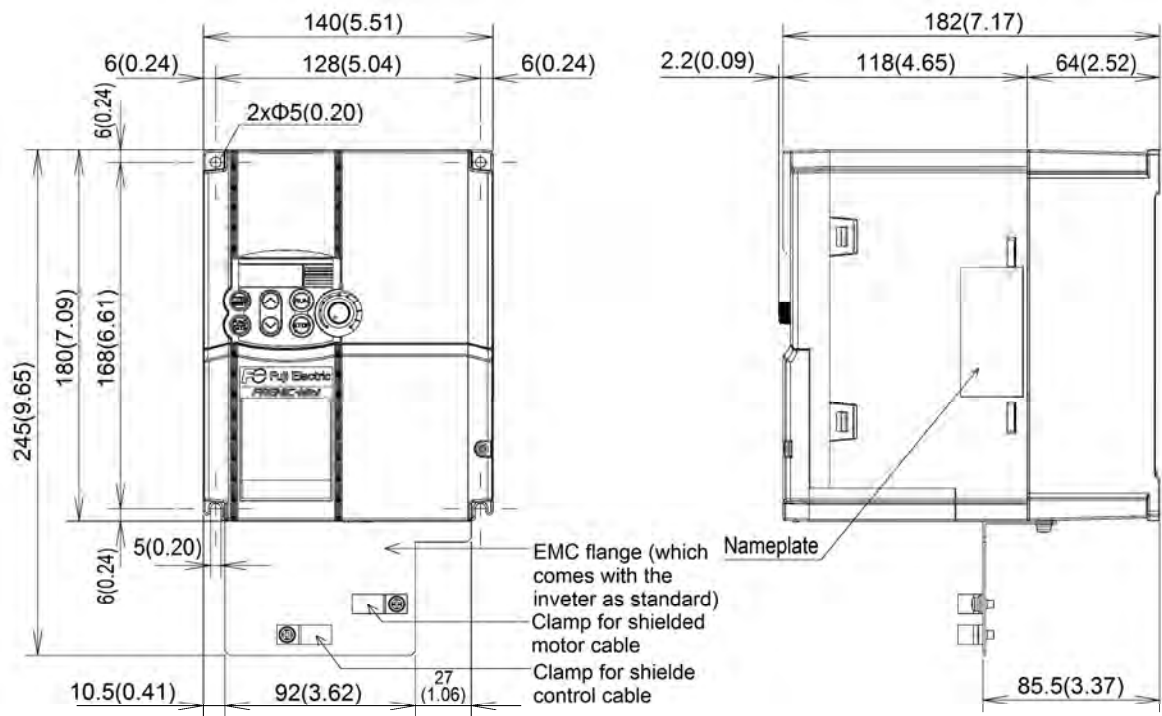

Unit: mm(inch)

Power supply voltage	Inverter type
Three-phase 400 V	FRN0005C2E-4□
	FRN0007C2E-4□
	FRN0011C2E-4□
Single-phase 200 V	FRN0010C2E-7□
	FRN0012C2E-7□

Note: A box (□) in the above table replaces A, C, E, or U depending on the shipping destination.

Figure D

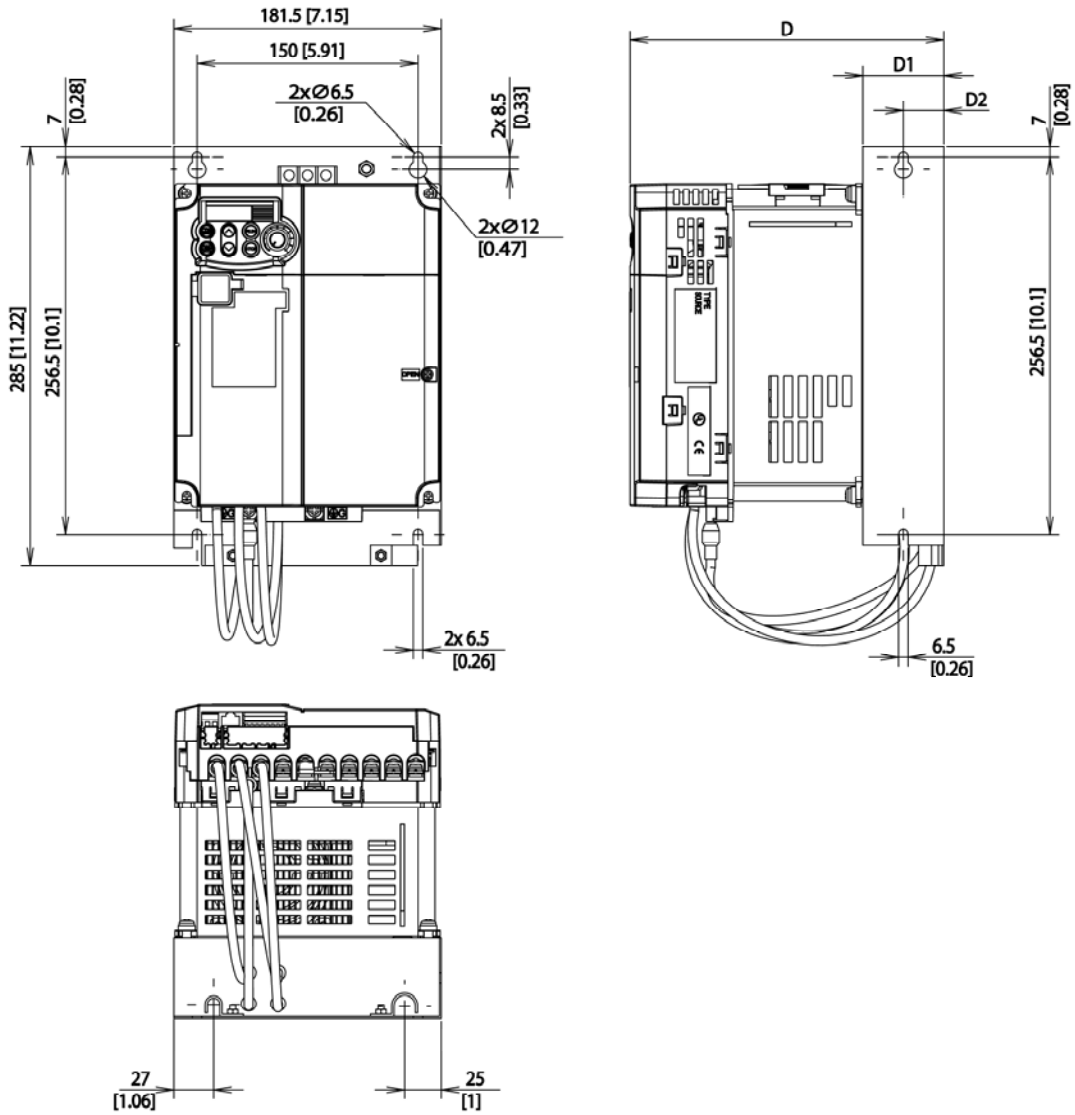

Power supply voltage	Inverter type
Three-phase 400 V	FRN0013C2E-4□
	FRN0018C2E-4□

Note: A box (□) in the above table replaces C or E depending on the shipping destination.

Figure E

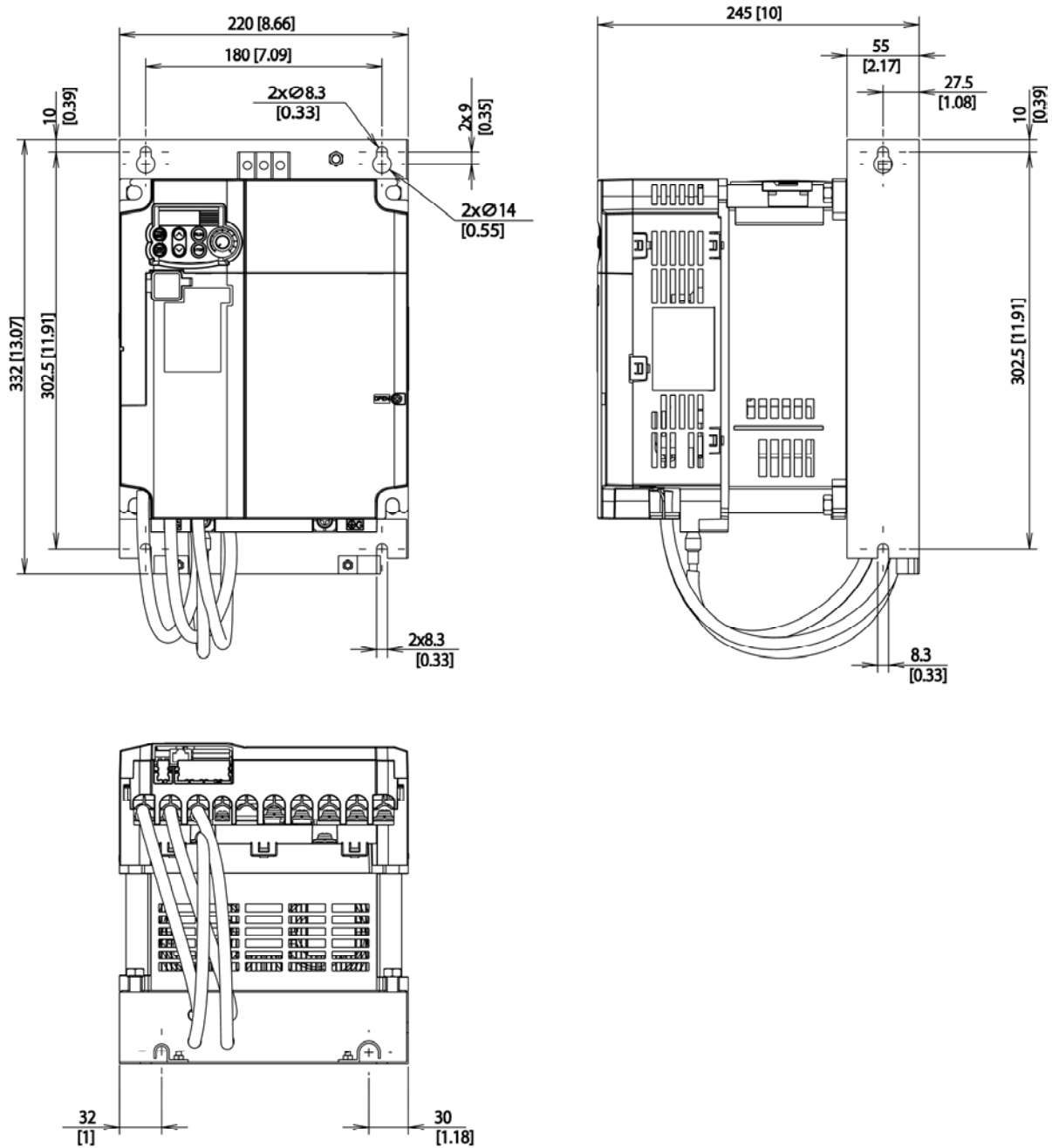

Power supply voltage	Inverter type
Three-phase 400 V	FRN0024C2E-4□
	FRN0030C2E-4□

Note: A box (□) in the above table replaces C or E depending on the shipping destination.

## 8.7 Connection Diagrams

### 8.7.1 Keypad operation

The connection diagram below shows an example for a keypad operation with the built-in potentiometer and keys.

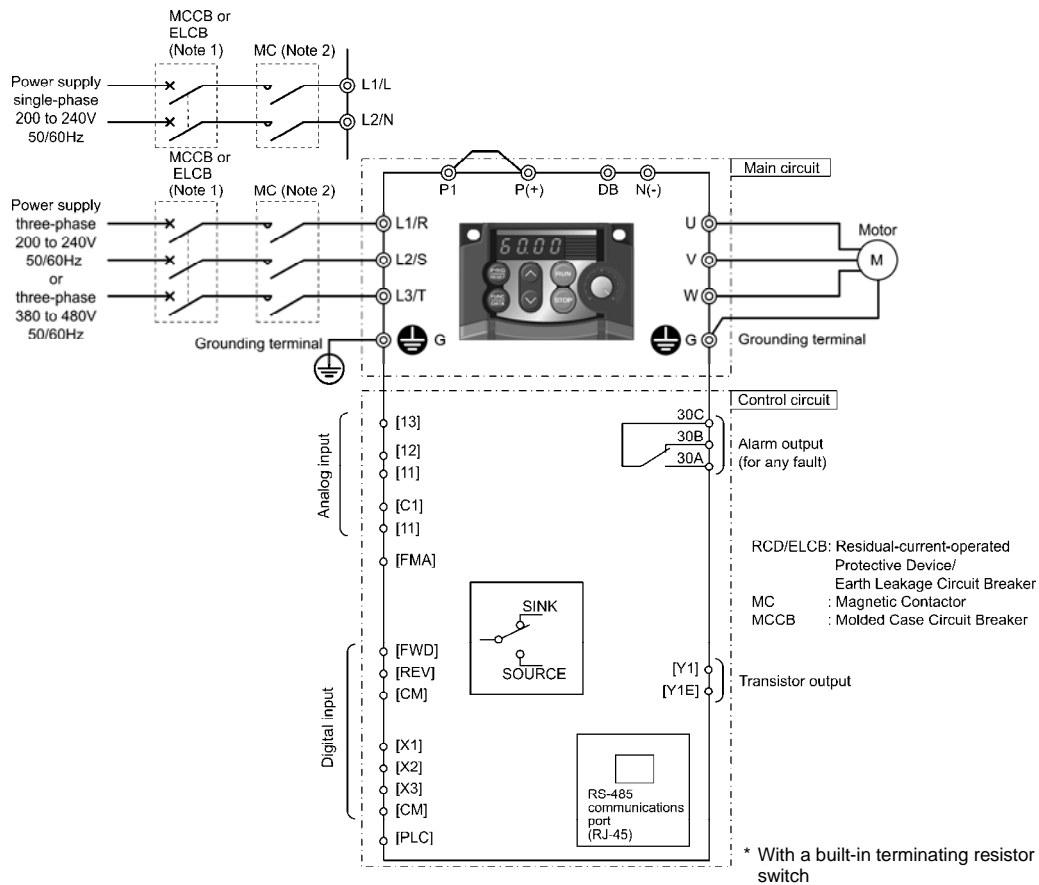

(Note 1) Install a recommended molded case circuit breaker (MCCB) or a residual-current-operated protective device (RCD)/earth leakage circuit breaker (ELCB) (with overcurrent protection) in the primary circuit of the inverter to protect wiring. Do not use an MCCB or RCD/ELCB whose capacity exceeds the recommended rated current.

(Note 2) A magnetic contactor (MC) should, if necessary, be mounted independent of the MCCB or ELCB to cut off the power fed to the inverter. Refer to Chapter 6, Section 6.3, [ 1 ] for details. MCs or solenoids that are to be installed close to the inverter require connecting surge absorbers in parallel to their coils.

## 8.7.2 Operation by external signal inputs

The basic connection diagram below shows an example for operation by external input signals.

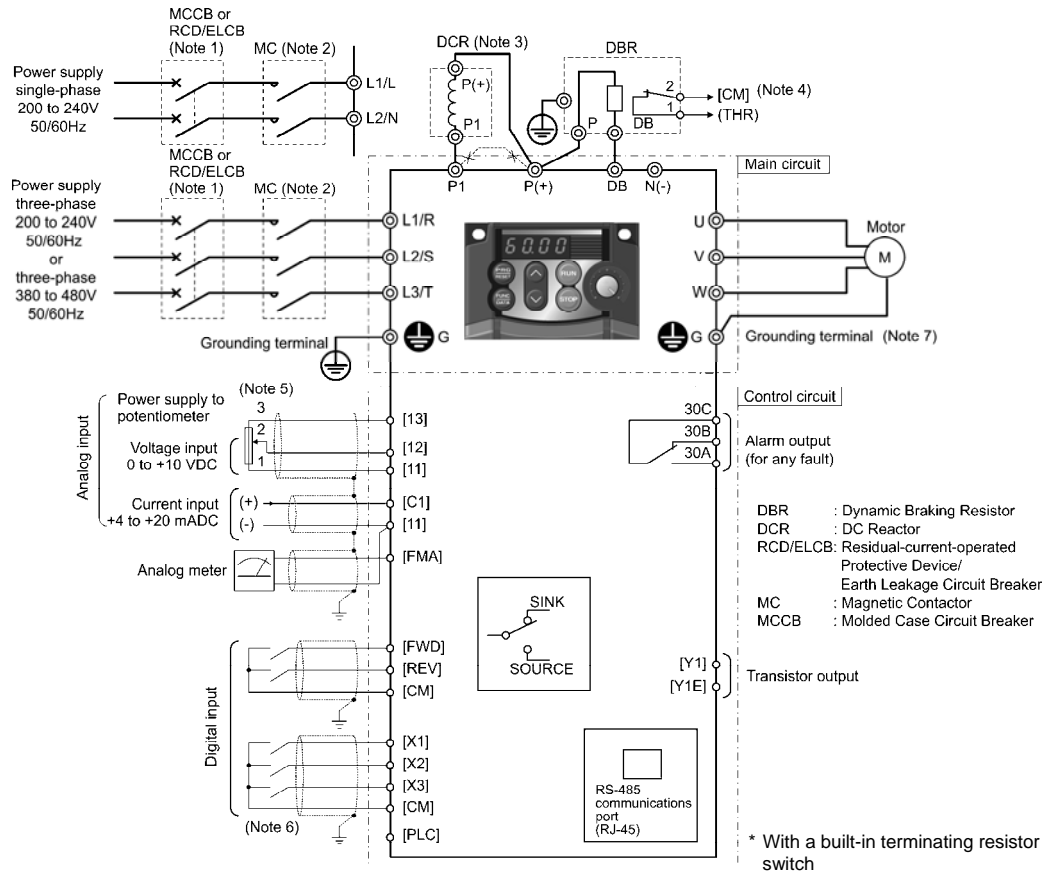

- (Note 1) Install a recommended molded case circuit breaker (MCCB) or a residual-current-operated protective device (RCD)/earth leakage circuit breaker (ELCB) (with overcurrent protection) in the primary circuit of the inverter to protect wiring. Do not use an MCCB or RCD/ELCB whose capacity exceeds the recommended rated current.
- (Note 2) A magnetic contactor (MC) should, if necessary, be mounted independent of the MCCB or ELCB to cut off the power fed to the inverter. Refer to Chapter 6, Section 6.3. [ 1 ] for details. MCs or solenoids that are to be installed close to the inverter require connecting surge absorbers in parallel to their coils.
- (Note 3) When connecting a DC reactor (option), remove the jumper bar from terminals [P1] and [P+]. Refer to Chapter 6, Section 6.3. [ 2 ] for details.
- (Note 4) The **THR** function can be used by assigning "9" (External alarm) to any of terminals [X1] to [X3], [FWD] or [REV] (function code E01 to E03, E98, or E99). For details, refer to Chapter 9.
- (Note 5) Frequency can be set by connecting a frequency setting device (external potentiometer) between terminals [11], [12], and [13] instead of inputting voltage signal (0 to +10 VDC or 0 to +5 VDC) between terminals [12] and [11].
- (Note 6) For the wiring of the control circuit, use shielded or twisted wires. When using shielded wires, connect the shields to earth. To prevent malfunction due to noise, keep the control circuit wiring away from the main circuit wiring as far as possible (recommended: 10 cm or longer), and never set them in the same wire duct. When crossing the control circuit wiring with the main circuit wiring, set them at right angles.
- (Note 7) A three-phase 4-wire cable is recommended for motor wiring to reduce the noise emitted. Connect the motor grounding wire to the inverter grounding terminal  $\ominus$ G.

The basic connection diagram above is for running/stopping the inverter and setting the frequency with external signals. Given below are connection notes.

- (1) Set function code F02 to "1" (External signals).
- (2) Set function code F01 to "1" (Voltage input to terminal [12]) or "2" (Current input to terminal [C1]).
- (3) Short-circuit terminals [FWD] and [CM] to run the motor in the forward direction and opening them to stop it. Short-circuit terminals [REV] and [CM] to run the motor in the reverse direction and opening them to stop it.
- (4) Frequency by voltage input is within the range from 0 to +10 VDC or 0 to the maximum frequency. Frequency by current input is within the range from +4 to +20 mADC or 0 to the maximum frequency.



## 8.8 Details of Protective Functions



The table below lists the name of the protective functions, description, display of LED monitor, whether alarms output or not at terminals [30A/B/C], and related function codes. If the LED monitor displays an alarm code, remove the cause of activation of the alarm function by referring to FRENIC-Mini Instruction Manual, Chapter 6, "TROUBLESHOOTING."

Name	Description	LED monitor displays	Alarm output [30A/B/C]	Related function code
Overcurrent protection Short-circuit protection Ground fault protection	<ul style="list-style-type: none"> <li>Stops the inverter output to protect the inverter from an overcurrent resulting from overload.</li> <li>Stops the inverter output to protect the inverter from an overcurrent due to a short circuit in the output circuit.</li> <li>Stops the inverter output to protect the inverter from an overcurrent due to a ground fault in the output circuit. This protection is effective only when the inverter starts. If you turn ON the inverter without removing the ground fault, this protection may not work.</li> </ul>	During acceleration	Yes	---
		During deceleration		
		During running at constant speed		
Overvoltage protection	Stops the inverter output upon detection of overvoltage (400 VDC for 200 V series and 800 VDC for 400 V series) in the DC link bus.  This protection is not assured if excess AC line voltage is applied inadvertently.	During acceleration	Yes	---
		During deceleration		
		During running at constant speed (Stopped)		
Undervoltage protection	Stops the inverter output when the DC link bus voltage drops below the undervoltage level (200 VDC for 200 V series and 400 VDC for 400 V series).  However, when F14 = 4 or 5, no alarm is output even if the DC link bus voltage drops.	LL	Yes (This alarm may not be outputted depending upon the data setting of the function code.)	F14
Input phase loss protection	Detects input phase loss, stopping the inverter output. This function prevents the inverter from undergoing heavy stress that may be caused by input phase loss or inter-phase voltage unbalance and may damage the inverter.  If connected load is light or a DC reactor is connected to the inverter, this function may not detect input phase loss if any.  In single-phase series of inverters, this function is disabled by factory default.	L 117	Yes	H98
Output phase loss protection	Detects breaks in inverter output wiring at the start of running and during running, stopping the inverter output.	OPL	Yes	H98

"---": Not applicable.

Name		Description	LED monitor displays	Alarm output [30A/B/C]	Related function code
Overheat protection	Inverter	<ul style="list-style-type: none"> <li>Stops the inverter output upon detection of excess heat sink temperature in case of cooling fan failure or overload.</li> </ul>	$\overline{OH1}$	Yes	H43
	Braking resistor	<ul style="list-style-type: none"> <li>Protects the braking resistor from overheat in accordance with the setting of the electronic thermal overload relay for braking resistor.</li> <li>When the braking resistor overheats, discharging and the operation of the inverter are stopped.</li> </ul> <p>* It is necessary to set the function code data according to the braking resistor used.</p>	$\overline{dbH}$	Yes	F50, F51
Overload protection		<p>Stops the inverter output according to the inverter heat sink temperature and the switching element temperature calculated from the output current.</p> <p>Stops the inverter output if the Insulated Gate Bipolar Transistor (IGBT) internal temperature calculated from the output current and cooling fan temperature detection exceeds the preset value.</p>	$\overline{OLU}$	Yes	---
Motor protection	Electronic thermal overload relay	<p>Stops the inverter output in accordance with the setting of the electronic thermal overload relay to protect the motor.</p> <p>This function protects general-purpose motors and inverter motors over the entire frequency range, as well as protecting the 2nd motor.</p> <p>* The operation level and thermal time constant (0.5 to 75.0 minutes) can be set.</p>	$\overline{OL1}$ $\overline{OL2}$	Yes	F10, H89  F11, F12
	PTC thermistor	<p>A PTC thermistor input stops the inverter output for motor protection.</p> <p>A PTC thermistor is connected between terminals [C1] and [11], and a resistor is connected between terminals [13] and [C1].</p>	$\overline{OH4}$	Yes	H26, H27
	Overload early warning	Outputs a preliminary alarm at a preset level before the motor is stopped by the electronic thermal overload protection for the purpose of protecting the motor.	---	---	E34, E35
Stall prevention		Operates if the inverter's output current exceeds the instantaneous overcurrent limit level, avoiding tripping of the inverter (during constant speed operation or during acceleration).	---	---	H12
External alarm input		Stops the inverter output with an alarm through the digital input signal (THR).	$\overline{OH2}$	Yes	E01 to E03, E98, E99
Alarm relay output (for any fault)		<p>The inverter outputs a relay contact signal when the inverter issues an alarm and stops the inverter output.</p> <p>&lt; Alarm Reset &gt; The alarm stop state is reset by pressing the  key or by the digital input signal <b>RST</b>.</p> <p>&lt; Saving the alarm history and detailed data &gt; The information on the previous 4 alarms can be saved and displayed.</p>	---	Yes	E20, E27, E01 to E03, E98, E99

---: Not applicable.

Name	Description		LED monitor displays	Alarm output [30A/B/C]	Related function code
Memory error	The inverter checks memory data after power-on and when the data is written. If a memory error is detected, the inverter stops.		$E-r-1$	Yes	---
Remote keypad (option) communications error	The inverter stops by detecting a communication error between the inverter and the remote keypad (option) during operation from the remote keypad.		$E-r-2$	Yes	F02
CPU error	If the inverter detects a CPU error caused by noise or some other factor, the inverter stops.		$E-r-3$	Yes	---
Operation error	STOP key priority	Pressing the  key on the keypad forces the inverter to decelerate and stop the motor even if the inverter is running by any run commands given via the terminals or communications (link operation). After the motor stops, the inverter issues alarm " $E-r-5$ ."	$E-r-5$	Yes	H96
	Start check function	Prohibits any run operations and displays " $E-r-5$ " on the LED monitor if a run command is present at the time of any of the following status changes. <ul style="list-style-type: none"> <li>- Powering up</li> <li>- An alarm (the  key turned ON) is released or an alarm reset (<b>RST</b>) is input.</li> <li>- Link command (<b>LE</b>) has switched inverter operation and the run command in the source to be switched is active.</li> </ul>			
Tuning error	Stops the inverter output when a tuning failure, interruption, or abnormal tuning result is detected during tuning of motor parameters.		$E-r-7$	Yes	---
RS-485 communications error	Upon detection of an RS-485 communications error, the inverter stops its output.		$E-r-8$	Yes	---
Data save error during undervoltage	If the data could not be saved during activation of the undervoltage protection function, the inverter displays the alarm code.		$E-r-F$	Yes	---
Retry function	When the inverter stops due to a trip, this function automatically resets the inverter and restarts it. (The number of retries and the latency between stop and reset can be specified.)		---	---	---
Surge protection	Protects the inverter against surge voltages which might appear between one of the power lines for the main circuit and the ground.		---	---	---

"---": Not applicable.

Name	Description	LED monitor displays	Alarm output [30A/B/C]	Related function code
Protection against momentary power failure	Upon detection of a momentary power failure lasting 15 ms or more, this function stops the inverter output.  If "restart after momentary power failure" is selected, this function invokes a restart process when power has been restored within a predetermined period.	---	---	---
Overload prevention control	In the event of overheating of the cooling fan or an overload condition (alarm display: $\overline{OH}$ or $\overline{OL}$ ), the output frequency of the inverter is reduced to keep the inverter from tripping.	---	---	H70
Mock alarm	A mock alarm can be generated with keypad operations to check the failure sequence.	$\overline{Err}$	Yes	H45
PID feedback wire break detection	Upon detection of a PID feedback wire break, this function outputs an alarm.	$\overline{CBF}$	Yes	H91
Step-out detection	Upon detection of a step-out of PMSM, the inverter stops its output.	$\overline{ErD}$	Yes	---

"---": Not applicable.

# Chapter 9

## FUNCTION CODES

This chapter contains overview lists of function codes available for the FRENIC-Mini series of inverters and details of each function code.

### Contents

9.1	Function Code Tables.....	9-1
9.2	Details of Function Codes.....	9-20
9.2.1	F codes (Fundamental functions).....	9-20
9.2.2	E codes (Extension terminal functions).....	9-47
9.2.3	C codes (Control functions).....	9-71
9.2.4	P codes (Motor 1 parameters).....	9-77
9.2.5	H codes (High performance functions).....	9-81
9.2.6	A codes (Motor 2 parameters).....	9-107
9.2.7	J codes (Application functions).....	9-109
9.2.8	y codes (Link functions).....	9-119
9.3	Notes in Driving PMSM.....	9-124



## 9.1 Function Code Tables









Function codes enable the FRENIC-Mini series of inverters to be set up to match your system requirements.

Each function code consists of a 3-letter alphanumeric string. The first letter is an alphabet that identifies its group and the following two letters are numerals that identify each individual code in the group. The function codes are classified into eight groups: Fundamental Functions (F codes), Extension Terminal Functions (E codes), Control Functions (C codes), Motor 1 Parameters (P codes), High Performance Functions (H codes), Motor 2 Parameters (A codes), Application Functions (J codes) and Link Functions (y codes). To determine the property of each function code, set data to the function code.

The following descriptions supplement those given in the function code tables on page 9-3 and subsequent pages.

### ■ Changing, validating, and saving function code data when the inverter is running

Function codes are indicated by the following based on whether they can be changed or not when the inverter is running:

Notation	Change when running	Validating and saving function code data
Y*	Possible	If the data of the codes marked with Y* is changed with  and  keys, the change will immediately take effect; however, the change is not saved into the inverter's memory. To save the change, press the  key. If you press the  key without pressing the  key to exit the current state, then the changed data will be discarded and the previous data will take effect for the inverter operation.
Y	Possible	Even if the data of the codes marked with Y is changed with  and  keys, the change will not take effect. Pressing the  key will make the change take effect and save it into the inverter's memory.
N	Impossible	—

### ■ Copying data

Connecting an optional remote keypad enables you to copy the function code data stored in the inverter's memory into the keypad's memory (refer to Menu #7 "Data copying" in Programming mode). With this feature, you can easily transfer all function code data saved in a source inverter to other destination inverters.

If the specifications of the source and destination inverters differ, some code data may not be copied to ensure safe operation of your power system. Whether data will be copied or not is detailed with the following symbols in the "Data copying" column of the function code tables given on the following pages.

- Y: Will be copied unconditionally.
- Y1: Will not be copied if the rated capacity differs from the source inverter.
- Y2: Will not be copied if the rated input voltage differs from the source inverter.
- N: Will not be copied. (Function codes marked with an "N" are not subject to Verify operation, either.)

If necessary, set up uncopied code data manually and individually.

For more information about the copy function, refer to the Remote Keypad Instruction Manual (INR-SI47-0790).

---

### ■ Using negative logic for programmable I/O terminals

The negative logic signaling system can be used for digital input terminals and transistor output terminals by setting the function code data specifying the properties for those terminals. Negative logic refers to the inverted ON/OFF (logical value 1 (true)/0 (false)) state of input or output signals. An active-ON signal (the function takes effect if the terminal is short-circuited.) in the normal logic system is functionally equivalent to active-OFF signal (the function takes effect if the terminal is opened.) in the negative logic system. Active-ON signals can be switched to active-OFF signals, and vice versa, with the function code data setting, except some signals.

To set the negative logic system for an input or output terminal, enter data of 1000s (by adding 1000 to the data for the normal logic) in the corresponding function code.

Example: "Coast to a stop" command **BX** assigned to any of digital input terminals [X1] to [X3] using any of function codes E01 through E03.

Function code data	<b>BX</b>
7	Turning <b>BX</b> ON causes the motor to coast to a stop. (Active-ON)
1007	Turning <b>BX</b> OFF causes the motor to coast to a stop. (Active-OFF)

### ■ Limitation of data displayed on the LED monitor

Only four digits can be displayed on the 4-digit LED monitor. If you enter more than 4 digits of data valid for a function code, any digits after the 4th digit of the set data will not be displayed, however they will be processed correctly.



The following tables list the function codes available for the FRENIC-Mini series of inverters.

### F codes: Fundamental Functions

Code	Name	Data setting range	Increment	Unit	Change when running	Data copying	Default setting (Note)	Refer to page:
F00	Data Protection	0: Disable both data protection and digital reference protection 1: Enable data protection and disable digital reference protection 2: Disable data protection and enable digital reference protection 3: Enable both data protection and digital reference protection	–	–	Y	Y	0	9-20
F01	Frequency Command 1	0: UP/DOWN keys on keypad 1: Voltage input to terminal [12] (0 to +10 VDC) 2: Current input to terminal [C1] (4 to 20 mA DC) 3: Sum of voltage and current inputs to terminals [12] and [C1] 4: Built-in potentiometer (POT) 7: Terminal command <b>UP/DOWN</b> control	–	–	N	Y	4	
F02	Operation Method	0: RUN/STOP keys on keypad (Motor rotational direction specified by terminal command <b>FWD/REV</b> ) 1: Terminal command <b>FWD</b> or <b>REV</b> 2: RUN/STOP keys on keypad (forward) 3: RUN/STOP keys on keypad (reverse)	–	–	N	Y	2	9-21
F03	Maximum Frequency 1	25.0 to 400.0	0.1	Hz	N	Y	ACU:60.0 E:50.0	9-22
F04	Base Frequency 1	25.0 to 400.0	0.1	Hz	N	Y	AU:60.0 CE:50.0	
F05	Rated Voltage at Base Frequency 1	0: Output a voltage in proportion to input voltage 80 to 240: Output an AVR-controlled voltage (for 200 V class series) *4 160 to 500: Output an AVR-controlled voltage (for 400 V class series)	1	V	N	Y2	ACE:0 U:230/460	
F06	Maximum Output Voltage 1	80 to 240: Output an AVR-controlled voltage (for 200 V class series) *4 160 to 500: Output an AVR-controlled voltage (for 400 V class series)	1	V	N	Y2	A:220/380 C:200/380 E:230/400 U:230/460	
F07	Acceleration Time 1	0.00 to 3600 Note: Entering 0.00 cancels the acceleration time, requiring external soft-start.	0.01	s	Y	Y	6.00	9-24
F08	Deceleration Time 1	0.00 to 3600 Note: Entering 0.00 cancels the deceleration time, requiring external soft-start.	0.01	s	Y	Y	6.00	
F09	Torque Boost 1	0.0 to 20.0 (percentage with respect to "F05: Rated Voltage at Base Frequency 1") Note: This setting takes effect when F37 = 0, 1, 3, or 4.	0.1	%	Y	Y	See Table A.	
F10	Electronic Thermal Overload Protection for Motor 1 (Motor characteristics)	1: For a general-purpose motor and Fuji standard permanent magnet synchronous motor with shaft-driven cooling fan 2: For an inverter-driven motor with separately powered cooling fan	–	–	Y	Y	1	9-27
F11	(Overload detection level)	0.00: Disable, 0.01 to 100.0 1 to 135% of the rated current (allowable continuous drive current) of the motor	0.01	A	Y	Y1 Y2	See Table A.	
F12	(Thermal time constant)	0.5 to 75.0	0.1	min	Y	Y	5.0	

(Note) Alphabets in the Default setting field denote shipping destination: A (Asia), C (China), E (Europe), and U (USA).

\*4 The setting for the 200 V class series applies also to the single-phase 100 V class series.

## (F code continued)

Code	Name	Data setting range	Increment	Unit	Change when running	Data copying	Default setting (Note)	Refer to page:
F14	Restart Mode after Momentary Power Failure (Mode selection)	0: Disable restart (Trip immediately) 1: Disable restart (Trip after a recovery from power failure) 2: Trip after decelerate-to-stop *2 4: Enable restart (Restart at the frequency at which the power failure occurred, for general loads) 5: Enable restart (Restart at the starting frequency)	—	—	Y	Y	AC:1 EU:0	9-30
F15	Frequency Limiter (High)	0.0 to 400.0	0.1	Hz	Y	Y	70.0	9-34
F16	(Low)	0.0 to 400.0	0.1	Hz	Y	Y	0.0	
F18	Bias (Frequency command 1)	-100.00 to 100.00 *1	0.01	%	Y*	Y	0.00	9-35
F20	DC Braking 1 (Braking starting frequency)	0.0 to 60.0	0.1	Hz	Y	Y	0.0	9-37
F21	(Braking level)	0 to 100 *3	1	%	Y	Y	0	
F22	(Braking time)	0.00 (Disable), 0.01 to 30.00	0.01	s	Y	Y	0.00	
F23	Starting Frequency 1	0.1 to 60.0	0.1	Hz	Y	Y	1.0	9-39
F24	(Holding time)	0.00 to 10.00	0.01	s	Y	Y	0.00	
F25	Stop Frequency	0.1 to 60.0	0.1	Hz	Y	Y	0.2	9-40
F26	Motor Sound (Carrier frequency)	0.75 to 16	1	kHz	Y	Y	ACU:2 E:15	
F27	(Tone)	0: Level 0 (Inactive) 1: Level 1 2: Level 2 3: Level 3	—	—	Y	Y	0	
F30	Analog Output [FMA] (Voltage adjustment)	0 to 300	1	%	Y*	Y	100	9-41
F31	(Function)	Select a function to be monitored from the followings. 0: Output frequency 1 (before slip compensation) 1: Output frequency 2 (after slip compensation) 2: Output current *3 3: Output voltage 6: Input power 7: PID feedback amount (PV) 9: DC link bus voltage 14: Calibration 15: PID command (SV) 16: PID output (MV)	—	—	Y	Y	0	
F37	Load Selection/ Auto Torque Boost/ Auto Energy Saving Operation 1	0: Variable torque load 1: Constant torque load 2: Auto-torque boost 3: Auto-energy saving operation (Variable torque load during ACC/DEC) 4: Auto-energy saving operation (Constant torque load during ACC/DEC) 5: Auto-energy saving operation (Auto-torque boost during ACC/DEC)	—	—	N	Y	1	9-42
F39	Stop Frequency (Holding Time)	0.00 to 10.00	0.01	s	Y	Y	0.00	9-42
F42	Control Mode Selection 1	0: V/f control with slip compensation inactive 1: Dynamic torque vector control 2: V/f control with slip compensation active 11: V/f control for PMSM drive *2	—	—	N	Y	0	

(Note) Alphabets in the Default setting field denote shipping destination: A (Asia), C (China), E (Europe), and U (USA).

\*1 When you make settings from the keypad, the incremental unit is restricted by the number of digits that the LED monitor can display.

(Example) If the setting range is from -200.00 to 200.00, the incremental unit is:

"1" for -200 to -100, "0.1" for -99.9 to -10.0 and for 100.0 to 200.0, and "0.01" for -9.99 to -0.01 and for 0.00 to 99.99.

\*2 Available in the ROM version 0500 or later.

\*3 For the single-phase 100 V class series, set the ratio relative to the reference current. Refer to Table B on page 9-19 for the reference current.

(F code continued)

Code	Name	Data setting range	Increment	Unit	Change when running	Data copying	Default setting (Note)	Refer to page:
F43	Current Limiter (Mode selection)	0: Disable (No current limiter works.) 1: Enable at constant speed (Disable during ACC/DEC) 2: Enable during ACC/constant speed operation	—	—	Y	Y	2	9-43
F44	(Level)	20 to 180: 3.7 kW (5 HP) or below 20 to 200: 5.5 kW (7.5 HP) or above (The data is interpreted as the rated output current of the inverter for 100%.) *3	1	%	Y	Y	160 or 180 *5	
F50	Electronic Thermal Overload Protection for Braking Resistor (Discharging capability)	1 to 900, OFF (Cancel)	1	kWs	Y	Y1 Y2	OFF	9-44
F51	(Allowable average loss)	0.001 to 50.00	0.001	kW	Y	Y1 Y2	0.001	

(Note) Alphabets in the Default setting field denote shipping destination: A (Asia), C (China), E (Europe), and U (USA).

\*3 For the single-phase 100 V class series, set the ratio relative to the reference current. Refer to Table B on page 9-19 for the reference current.

\*5 160 for inverters of 3.7 kW (5 HP) or below; 180 for those of 5.5 kW (7.5 HP) or above.

## E codes: Extension Terminal Functions

Code	Name	Data setting range	Increment	Unit	Change when running	Data copying	Default setting (Note)	Refer to page:
E01	Terminal [X1] Function	Selecting function code data assigns the corresponding function to terminals [X1] to [X3] as listed below.	–	–	N	Y	0	9-47
E02	Terminal [X2] Function	0 (1000): Select multistep frequency ( <b>SS1</b> )	–	–	N	Y	7	
E03	Terminal [X3] Function	1 (1001): Select multistep frequency ( <b>SS2</b> ) 2 (1002): Select multistep frequency ( <b>SS4</b> ) 3 (1003): Select multistep frequency ( <b>SS8</b> ) 4 (1004): Select ACC/DEC time ( <b>RT1</b> ) 6 (1006): Enable 3-wire operation ( <b>HLD</b> ) 7 (1007): Coast to a stop ( <b>BX</b> ) 8 (1008): Reset alarm ( <b>RST</b> ) 9 (1009): Enable external alarm trip ( <b>THR</b> ) 10 (1010): Ready for jogging ( <b>JOG</b> ) 11 (1011): Select frequency command 2/1 ( <b>Hz2/Hz1</b> ) 12 (1012): Select motor 2/motor 1 ( <b>M2/M1</b> ) 13: Enable DC braking ( <b>DCBRK</b> ) 17 (1017): UP (Increase output frequency) ( <b>UP</b> ) 18 (1018): DOWN (Decrease output frequency) ( <b>DOWN</b> ) 19 (1019): Enable data change with keypad ( <b>WE-KP</b> ) 20 (1020): Cancel PID control ( <b>Hz/PID</b> ) 21 (1021): Switch normal/inverse operation ( <b>IVS</b> ) 24 (1024): Enable communications link via RS-485 ( <b>LE</b> ) 33 (1033): Reset PID integral and differential components ( <b>PID-RST</b> ) 34 (1034): Hold PID integral component ( <b>PID-HLD</b> ) Setting the value in parentheses ( ) shown above assigns a negative logic input (Active-OFF) to a terminal. Note that, in the case of <b>THR</b> , data "1009" is for normal logic (Active-ON) and "9," for negative logic (Active-OFF). Signals having no value in parentheses ( ) cannot be used for negative logic.	–	–	N	Y	8	
E10	Acceleration Time 2	0.00 to 3600 Note: Entering 0.00 cancels the acceleration time, requiring external soft-start and -stop.	0.01	s	Y	Y	6.00	9-57
E11	Deceleration Time 2	0.00 to 3600 Note: Entering 0.00 cancels the deceleration time, requiring external soft-start and -stop.	0.01	s	Y	Y	6.00	
E20	Terminal [Y1] Function	Selecting function code data assigns the corresponding function to terminals [Y1] and [30A/B/C] as listed below.	–	–	N	Y	0	9-58
E27	Terminal [30A/B/C] Function	0 (1000): Inverter running ( <b>RUN</b> ) 1 (1001): Frequency arrival signal ( <b>FAR</b> ) 2 (1002): Frequency detected ( <b>FDT</b> ) 3 (1003): Undervoltage detected (Inverter stopped) ( <b>LU</b> ) 5 (1005): Inverter output limiting ( <b>IOL</b> ) 6 (1006): Auto-restarting after momentary power failure ( <b>IPF</b> ) 7 (1007): Motor overload early warning ( <b>OL</b> ) 26 (1026): Auto-resetting ( <b>TRY</b> ) 30 (1030): Service lifetime alarm ( <b>LIFE</b> ) 35 (1035): Inverter running 2 ( <b>RUN2</b> ) 36 (1036): Overload prevention control ( <b>OLP</b> ) 37 (1037): Current detected ( <b>ID</b> ) 38 (1038): Current detected 2 ( <b>ID2</b> )	–	–	N	Y	99	

(Note) Alphabets in the Default setting field denote shipping destination: A (Asia), C (China), E (Europe), and U (USA).

(E code continued)

Code	Name	Data setting range	Increment	Unit	Change when running	Data copying	Default setting (Note)	Refer to page:
		41 (1041): Low current detected ( <i>IDL</i> ) 43 (1043): Under PID control ( <i>PID-CTL</i> ) 44 (1044): Motor stopped due to slow flowrate under PID control ( <i>PID-STP</i> ) 49 (1049): Switched to motor 2 ( <i>SWM2</i> ) 56 (1056): Motor overheat detected by thermistor ( <i>THM</i> ) 57 (1057): Brake signal ( <i>BRKS</i> ) 59 (1059): Terminal [C1] wire break ( <i>C1OFF</i> ) 84 (1084): Maintenance timer ( <i>MNT</i> ) 87 (1087): Frequency arrival detected ( <i>FARFDT</i> ) 99 (1099): Alarm output (for any alarm) ( <i>ALM</i> ) Setting the value in parentheses ( ) shown above assigns a negative logic output to a terminal.						9-58
E30	Frequency Arrival (Hysteresis width)	0.0 to 10.0	0.1	Hz	Y	Y	2.5	9-63
E31	Frequency Detection (Detection level)	0.0 to 400.0	0.1	Hz	Y	Y	ACU:60.0 E:50.0	
E32	Frequency Detection (Hysteresis width)	0.0 to 400.0	0.1	Hz	Y	Y	1.0	
E34	Overload Early Warning/ Current Detection/ Low Current Detection (Level)	0.00 (Disable), 0.01 to 100.0 Current value of 1 to 200% of the inverter rated current	0.01	A	Y	Y1 Y2	See Table A.	9-64
E35	Overload Early Warning/ Current Detection/ Low Current Detection (Timer)	0.01 to 600.00 *1	0.01	s	Y	Y	10.00	
E37	Current Detection 2 (Level)	0.00 (Disable), 0.01 to 100.0 Current value of 1 to 200% of the inverter rated current	0.01	A	Y	Y1 Y2	See Table A.	
E38	Current Detection 2 (Timer)	0.01 to 600.00 *1	0.01	s	Y	Y	10.00	
E39	Coefficient for Constant Feeding Rate Time	0.000 to 9.999	0.001	-	Y	Y	0.000	9-66
E40	PID Display Coefficient A	-999 to 0.00 to 9990 *6	0.01	-	Y	Y	100	
E41	PID Display Coefficient B	-999 to 0.00 to 9990 *6	0.01	-	Y	Y	0.00	
E42	LED Display Filter	0.0 to 5.0	0.1	s	Y	Y	0.5	9-67
E43	LED Monitor (Display item)	0: Speed monitor (select by E48) 3: Output current 4: Output voltage 9: Input power 10: PID command 12: PID feedback amount 13: Timer 14: PID output 25: Input watt-hour	-	-	Y	Y	0	9-68
E45	*7							-
E46								
E47								
E48	LED Monitor (Speed monitor item)	0: Output frequency (Before slip compensation) 1: Output frequency (After slip compensation) 2: Reference frequency 4: Load shaft speed in r/min 5: Line speed in m/min 6: Constant feeding rate time	-	-	Y	Y	0	9-69

(Note) Alphabets in the Default setting field denote shipping destination: A (Asia), C (China), E (Europe), and U (USA).

\*1 When you make settings from the keypad, the incremental unit is restricted by the number of digits that the LED monitor can display.

(Example) If the setting range is from -200.00 to 200.00, the incremental unit is:

"1" for -200 to -100, "0.1" for -99.9 to -10.0 and for 100.0 to 200.0, and "0.01" for -9.99 to -0.01 and for 0.00 to 99.99.

\*6 The significant figure is in three digits, so the incremental unit changes depending upon the magnitude of absolute values.

(Example) The incremental unit is "10" for 1000 to 9990, "1" for -999 to -100 and for 100 to 999, "0.1" for -99.9 to -10.0 and for 10.0 to 99.9, and "0.01" for -9.99 to 9.99.

\*7 E45, E46 and E47 appear on the LED monitor, but cannot be used by this inverter.

(E code continued)

Code	Name	Data setting range	Increment	Unit	Change when running	Data copying	Default setting (Note)	Refer to page:
E50	Coefficient for Speed Indication	0.01 to 200.00 *1	0.01	—	Y	Y	30.00	9-69
E51	Display Coefficient for Input Watt-hour Data	0.000 (Cancel/reset), 0.001 to 9999	0.001	—	Y	Y	0.010	
E52	Keypad (Menu display mode)	0: Function code data editing mode (Menu #1) 1: Function code data check mode (Menu #2) 2: Full-menu mode (Menus #0 through #6)	—	—	Y	Y	0	
E60	Built-in Potentiometer (Function selection)	0: None 1: Auxiliary frequency command 1 2: Auxiliary frequency command 2 3: PID process command 1	1	—	N	Y	0	9-70
E61	Terminal [12] Extended Function	Selecting function code data assigns the corresponding function to terminals [12] and	—	—	N	Y	0	
E62	Terminal [C1] Extended Function	[C1] as listed below. 0: None 1: Auxiliary frequency command 1 2: Auxiliary frequency command 2 3: PID process command 1 5: PID feedback value	—	—	N	Y	0	
E98	Terminal [FWD] Function	Selecting function code data assigns the corresponding function to terminals [FWD] and	—	—	N	Y	98	
E99	Terminal [REV] Function	[REV] as listed below. 0 (1000): Select multistep frequency ( <b>SS1</b> ) 1 (1001): Select multistep frequency ( <b>SS2</b> ) 2 (1002): Select multistep frequency ( <b>SS4</b> ) 3 (1003): Select multistep frequency ( <b>SS8</b> ) 4 (1004): Select ACC/DEC time ( <b>RT1</b> ) 6 (1006): Enable 3-wire operation ( <b>HLD</b> ) 7 (1007): Coast to a stop ( <b>BX</b> ) 8 (1008): Reset alarm ( <b>RST</b> ) 9 (1009): Enable external alarm trip ( <b>THR</b> ) 10 (1010): Ready for jogging ( <b>JOG</b> ) 11 (1011): Select frequency command 2/1 ( <b>Hz2/Hz1</b> ) 12 (1012): Select motor 2/motor 1 ( <b>M2/M1</b> ) 13: Enable DC braking ( <b>DCBRK</b> ) 17 (1017): UP (Increase output frequency) ( <b>UP</b> ) 18 (1018): DOWN (Decrease output frequency) ( <b>DOWN</b> ) 19 (1019): Enable data change with keypad ( <b>WE-KP</b> ) 20 (1020): Cancel PID control ( <b>Hz/PID</b> ) 21 (1021): Switch normal/inverse operation ( <b>IVS</b> ) 24 (1024): Enable communications link via RS-485 ( <b>LE</b> ) 33 (1033): Reset PID integral and differential components ( <b>PID-RST</b> ) 34 (1034): Hold PID integral component ( <b>PID-HLD</b> ) 98: Run forward ( <b>FWD</b> ) 99: Run reverse ( <b>REV</b> ) Setting the value in parentheses ( ) shown above assigns a negative logic input (Active-OFF) to a terminal. Note that, in the case of <b>THR</b> , data "1009" is for normal logic (Active-ON) and "9," for negative logic (Active-OFF). Signals having no value in parentheses ( ) cannot be used for negative logic.	—	—	N	Y	99	

(Note) Alphabets in the Default setting field denote shipping destination: A (Asia), C (China), E (Europe), and U (USA).

\*1 When you make settings from the keypad, the incremental unit is restricted by the number of digits that the LED monitor can display.

(Example) If the setting range is from -200.00 to 200.00, the incremental unit is:

"1" for -200 to -100, "0.1" for -99.9 to -10.0 and for 100.0 to 200.0, and "0.01" for -9.99 to -0.01 and for 0.00 to 99.99.

## C codes: Control Functions

Code	Name	Data setting range	Increment	Unit	Change when running	Data copying	Default setting (Note)	Refer to page:
C01	Jump Frequency 1	0.0 to 400.0	0.1	Hz	Y	Y	0.0	9-71
C02	2				Y	Y	0.0	
C03	3				Y	Y	0.0	
C04	(Hysteresis width)	0.0 to 30.0	0.1	Hz	Y	Y	3.0	
C05	Multistep Frequency 1	0.00 to 400.00 *1	0.01	Hz	Y	Y	0.00	9-72
C06	2				Y	Y	0.00	
C07	3				Y	Y	0.00	
C08	4				Y	Y	0.00	
C09	5				Y	Y	0.00	
C10	6				Y	Y	0.00	
C11	7				Y	Y	0.00	
C12	8				Y	Y	0.00	
C13	9				Y	Y	0.00	
C14	10				Y	Y	0.00	
C15	11				Y	Y	0.00	
C16	12				Y	Y	0.00	
C17	13				Y	Y	0.00	
C18	14				Y	Y	0.00	
C19	15				Y	Y	0.00	
C20	Jogging Frequency	0.00 to 400.00 *1	0.01	Hz	Y	Y	0.00	9-73
C21	Timer Operation	0: Disable 1: Enable	-	-	N	Y	0	9-74
C30	Frequency Command 2	0: UP/DOWN keys on keypad 1: Voltage input to terminal [12] (0 to +10 VDC) 2: Current input to terminal [C1] (4 to 20 mA DC) 3: Sum of voltage and current inputs to terminals [12] and [C1] 4: Built-in potentiometer (POT) 7: Terminal command <b>UP/DOWN</b> control	-	-	N	Y	2	
C32	Analog Input Adjustment for Terminal [12] (Gain)	0.00 to 200.00 *1	0.01	%	Y*	Y	100.0	9-75
C33	(Filter time constant)	0.00 to 5.00	0.01	s	Y	Y	0.05	
C34	(Gain base point)	0.00 to 100.00 *1	0.01	%	Y*	Y	100.0	
C37	Analog Input Adjustment for Terminal [C1] (Gain)	0.00 to 200.00 *1	0.01	%	Y*	Y	100.0	
C38	(Filter time constant)	0.00 to 5.00	0.01	s	Y	Y	0.05	
C39	(Gain base point)	0.00 to 100.00 *1	0.01	%	Y*	Y	100.0	
C40	Terminal [C1] Input Range Selection	0: 4 to 20 mA 1: 0 to 20 mA	-	-	N	Y	0	
C50	Bias (Frequency command 1) (Bias base point)	0.00 to 100.00 *1	0.01	%	Y*	Y	0.00	9-76
C51	Bias (PID command 1) (Bias value)	-100.00 to 100.00 *1	0.01	%	Y*	Y	0.00	
C52	(Bias base point)	0.00 to 100.00 *1	0.01	%	Y*	Y	0.00	
C94	Jump Frequency 4 *2	0.0 to 400.0	0.1	Hz	Y	Y	0.0	9-71
C95	5				Y	Y	0.0	9-76
C96	6				Y	Y	0.0	
C99	Digital Reference Frequency *2	0.00 to 400.00 (This data can be seen only from the keypad.)	0.01	Hz	Y	Y	0.00	9-76

(Note) Alphabets in the Default setting field denote shipping destination: A (Asia), C (China), E (Europe), and U (USA).

\*1 When you make settings from the keypad, the incremental unit is restricted by the number of digits that the LED monitor can display.

(Example) If the setting range is from -200.00 to 200.00, the incremental unit is:

"1" for -200 to -100, "0.1" for -99.9 to -10.0 and for 100.0 to 200.0, and "0.01" for -9.99 to -0.01 and for 0.00 to 99.99.

\*2 Available in the ROM version 0500 or later.

## P codes: Motor 1 Parameters

Code	Name	Data setting range	Increment	Unit	Change when running	Data copying	Default setting (Note)	Refer to page:
P02	Motor 1 (Rated capacity)	0.01 to 30.00 (kW when P99 = 0, 3, 4, 20 or 21) 0.01 to 30.00 (HP when P99 = 1)	0.01 0.01	kW HP	N	Y1 Y2	See Table A.	9-77
P03	(Rated current)	0.00 to 100.0	0.01	A	N	Y1 Y2	Rated value of Fuji standard motor	
P04	(Auto-tuning)	0: Disable 1: Tune when the motor stops (%R1, %X) 2: Tune when the motor is rotating under V/f control (%R1, %X, no-load current, slip frequency)	–	–	N	N	0	
P06	(No-load current)	0.00 to 50.00	0.01	A	N	Y1 Y2	Rated value of Fuji standard motor	9-78
P07	(%R1)	0.00 to 50.00	0.01	%	Y	Y1 Y2		
P08	(%X)	0.00 to 50.00	0.01	%	Y	Y1 Y2		
P09	(Slip compensation gain for driving)	0.0 to 200.0	0.1	%	Y*	Y	100.0	9-79
P10	(Slip compensation response time)	0.01 to 10.00	0.01	s	Y	Y1 Y2	1.00	
P11	(Slip compensation gain for braking)	0.0 to 200.0	0.1	%	Y*	Y	100.0	
P12	(Rated slip frequency)	0.00 to 15.00	0.01	Hz	N	Y1 Y2	Rated value of Fuji standard motor	
P60	Permanent magnet synchronous motor *2 (Armature resistance)	0.00 (Disable PMSM), 0.01 to 50.00	0.01	Ω	Y	Y1 Y2	0.00	9-80
P61	(d-axis inductance)	0.00 (Disable high-efficiency control), 0.01 to 500.0	0.01	mH	Y	Y1 Y2	0.00	
P62	(q-axis inductance)	0.00 (Disable PMSM), 0.01 to 500.0	0.01	mH	Y	Y1 Y2	0.00	
P63	(Induced voltage)	0 (Disable PMSM), 80 to 240 (for 200 V class series) *4 160 to 500 (for 400 V class series)	1	V	N	Y2	0	
P74	(Reference current at starting)	10 to 200	1	%	Y	Y1 Y2	80	
P89	(Control switching level)	10 to 100	1	%	Y	Y1 Y2	10	
P90	(Overcurrent protection level)	0.00 (Disable), 0.01 to 300.0	0.01	A	Y	Y1 Y2	0.00	

(Note) Alphabets in the Default setting field denote shipping destination: A (Asia), C (China), E (Europe), and U (USA).

\*2 The PMSM drive is available in the ROM version 0500 or later.

\*4 The setting for the 200 V class series applies also to the single-phase 100 V class series.



(P code continued)

Code	Name	Data setting range	Increment	Unit	Change when running	Data copying	Default setting (Note)	Refer to page:
P91	Permanent magnet synchronous motor *2 (d-axis compensation gain under damping control)	0.00 to 25.00, 999 (Table value)	0.01	–	Y	Y1 Y2	999	9-80
P92	(q-axis compensation gain under damping control)	0.00 to 25.00, 999 (Table value)	0.01	–	Y	Y1 Y2	999	
P93	(Step-out detection current level)	0 to 100, 999 (Table value)	1	%	Y	Y1 Y2	999	
P99	Motor 1 Selection	0: Motor characteristics 0 (Fuji standard IM, 8-series) 1: Motor characteristics 1 (HP rating IM) 3: Motor characteristics 3 (Fuji standard IM, 6-series) 4: Other motors (IM) 20: Other motors (PMSM) 21: Fuji standard PMSM without sensor	–	–	N	Y1 Y2	ACE:0 U:1	9-79

(Note) Alphabets in the Default setting field denote shipping destination: A (Asia), C (China), E (Europe), and U (USA).

\*2 The PMSM drive is available in the ROM version 0500 or later.

## H codes: High Performance Functions

Code	Name	Data setting range	Increment	Unit	Change when running	Data copying	Default setting (Note)	Refer to page:
H03	Data Initialization	0: Disable initialization 1: Initialize all function code data to the factory defaults 2: Initialize motor 1 parameters 3: Initialize motor 2 parameters	–	–	N	N	0	9-81
H04	Auto-reset (Times)	0 (Disable), 1 to 10	1	times	Y	Y	0	9-91
H05	(Reset interval)	0.5 to 20.0	0.1	s	Y	Y	5.0	
H06	Cooling Fan ON/OFF Control	0: Disable (Cooling fan always ON) 1: Enable (ON/OFF control effective)	–	–	Y	Y	0	9-92
H07	Acceleration/Deceleration Pattern	0: Linear 1: S-curve (Weak) 2: S-curve (Strong) 3: Curvilinear	–	–	Y	Y	0	9-93
H08	Rotational Direction Limitation	0: Disable 1: Enable (Reverse rotation inhibited ) 2: Enable (Forward rotation inhibited )	–	–	N	Y	0	9-94
H11	Deceleration Mode	0: Normal deceleration 1: Coast-to-stop	–	–	Y	Y	0	9-95
H12	Instantaneous Overcurrent Limiting (Mode selection)	0: Disable 1: Enable	–	–	Y	Y	1	
H13	Restart Mode after Momentary Power Failure (Restart time)	0.1 to 10.0	0.1	s	Y	Y1 Y2	See Table A.	9-96
H14	(Frequency fall rate)	0.00 (Deceleration time selected) 0.01 to 100.00 999 (Depends upon current limiter)	0.01	Hz/s	Y	Y	999	
H15	(Continuous running level) *2	200 to 300 V for 200 V class series *4 400 to 600 V for 400 V class series	1	V	Y	Y2	235 470	
H26	Thermistor for Motor (Mode selection)	0: Disable 1: Enable (With PTC, the inverter immediately trips with $\overline{OH}$ displayed.) 2: Enable (With PTC, the inverter issues output signal <b>THM</b> and continues to run.)	–	–	Y	Y	0	
H27	(Level)	0.00 to 5.00	0.01	V	Y	Y	0.16 or 1.60 *8	
H30	Communications Link Function (Mode selection)	Frequency command    Run command 0:    F01/C30            F02 1:    RS-485            F02 2:    F01/C30            RS-485 3:    RS-485            RS-485	–	–	Y	Y	0	9-97
H42	Capacitance of DC Link Bus Capacitor	Indication for replacement of DC link bus capacitor (0000 to FFFF in hex.)	1	–	Y	N	–	9-98
H43	Cumulative Run Time of Cooling Fan	Indication for replacement of cooling fan (0 to 9999, in units of 10 hours)	1	10h	Y	N	–	
H44	Startup Counter of Motor 1	Indication of cumulative startup count (0000 to FFFF in hex.)	–	–	Y	N	–	
H45	Mock Alarm	0: Disable 1: Enable (Once a mock alarm occurs, the data automatically returns to 0.)	–	–	Y	N	0	
H47	Initial Capacitance of DC Link Bus Capacitor	Indication for replacement of DC link bus capacitor (0000 to FFFF in hex.)	1	–	Y	N	–	
H48	Cumulative Run Time of Capacitors on Printed Circuit Boards	Indication for replacement of capacitors on printed circuit boards (0 to 9999, in units of 10 hours)	1	10h	Y	N	–	

(Note) Alphabets in the Default setting field denote shipping destination: A (Asia), C (China), E (Europe), and U (USA).

\*2 Available in the ROM version 0500 or later.

\*4 The setting for the 200 V class series applies also to the single-phase 100 V class series.

\*8 1.60 in the ROM version 0800 or later; 0.16 in earlier ROM versions.

(H code continued)

Code	Name	Data setting range	Increment	Unit	Change when running	Data copying	Default setting (Note)	Refer to page:
H50	Non-linear V/f Pattern 1 (Frequency)	0.0 (Cancel), 0.1 to 400.0	0.1	Hz	N	Y	0.0	9-99
H51	(Voltage)	0 to 240: Output an AVR-controlled voltage (for 200 V class series) *4 0 to 500: Output an AVR-controlled voltage (for 400 V class series)	1	V	N	Y2	ACE:0 U:230/460	
H52	Non-linear V/f Pattern 2 (Frequency)	0.0 (Cancel), 0.1 to 400.0	0.1	Hz	N	Y	0.0	
H53	(Voltage)	0 to 240: Output an AVR-controlled voltage (for 200 V class series) *4 0 to 500: Output an AVR-controlled voltage (for 400 V class series)	1	V	N	Y2	0	
H54	ACC/DEC Time (Jogging operation)	0.00 to 3600	0.01	s	Y	Y	6.00	
H61	<b>UP/DOWN</b> Control (Initial frequency setting)	0: 0.00 1: Last <b>UP/DOWN</b> command value on releasing a run command	–	–	N	Y	1	
H63	Low Limiter (Mode selection)	0: Limit by F16 (Frequency limiter: Low) and continue to run 1: If the output frequency lowers below the one limited by F16 (Frequency limiter: Low), decelerate to stop the motor.	–	–	Y	Y	0	
H64	(Lower limiting frequency)	0.0 (Depends on F16 (Frequency limiter: Low)) 0.1 to 60.0	0.1	Hz	Y	Y	2.0	
H69	Automatic Deceleration (Anti-regenerative control) (Mode selection)	0: Disable 1: Enable (Lengthen the deceleration time to three times the specified time under voltage limiting control.) (Compatible with the original FRENIC-Mini series FRN□□□C1□-□□) 2: Enable (Torque limit control: Cancel the anti-regenerative control if the actual deceleration time exceeds three times the specified one.) 4: Enable (Torque limit control: Disable force-to-stop processing.)	–	–	Y	Y	0	9-100
H70	Overload Prevention Control	0.00: Follow deceleration time specified by F08/E11 0.01 to 100.0, 999 (Cancel)	0.01	Hz/s	Y	Y	999	
H71	Deceleration Characteristics	0: Disable 1: Enable	–	–	Y	Y	0	9-101
H76	Automatic Deceleration (Frequency increment limit for braking)	0.0 to 400.0	0.1	Hz	Y	Y	5.0	
H78	Maintenance Interval (M1) *2	0: Disable; 1 to 9999 (in units of 10 hours)	1	–	Y	Y	8760	
H79	Preset Startup Count for Maintenance (M1) *2	0000: Disable; 0001 to FFFF (hex.)	1	–	Y	Y	0	9-102
H80	Output Current Fluctuation Damping Gain for Motor 1	0.00 to 0.40	0.01	–	Y	Y	0.20	9-103
H89	Electronic Thermal Overload Protection for Motor (Data retention)	0: Disable 1: Enable	–	–	Y	Y	1	
H91	PID Feedback Wire Break Detection (Terminal [C1])	0.0: Disable alarm detection 0.1 to 60.0: After the specified time, cause alarm	0.1	s	Y	Y	0.0	
H92	Continuity of Running *2 (P)	0.000 to 10.000 times; 999	0.001	times	Y	Y1Y2	999	9-30
H93	(I)	0.010 to 10.000 s; 999	0.001	s	Y	Y1Y2	999	9-104

(Note) Alphabets in the Default setting field denote shipping destination: A (Asia), C (China), E (Europe), and U (USA).

\*2 Available in the ROM version 0500 or later.

\*4 The setting for the 200 V class series applies also to the single-phase 100 V class series.

## (H code continued)

Code	Name	Data setting range	Increment	Unit	Change when running	Data copying	Default setting (Note)	Refer to page:
H94	Cumulative Run Time of Motor 1	0 to 9999 (in units of 10 hours)	–	–	N	N	–	9-104
H95	DC Braking (Braking response mode)	0: Slow 1: Quick	–	–	Y	Y	ACU:0 E:1	
H96	STOP Key Priority/Start Check Function	Data STOP key priority Start check function 0: Disable Disable 1: Enable Disable 2: Disable Enable 3: Enable Enable	–	–	Y	Y	ACE:0 U:3	
H97	Clear Alarm Data	0: Disable 1: Clear alarm data	–	–	Y	N	0	9-105
H98	Protection/Maintenance Function (Mode selection)	0 to 31 (decimal) Bit 0: Lower the carrier frequency automatically (0: Disable; 1: Enable) Bit 1: Detect input phase loss (0: Disable; 1: Enable) Bit 2: Detect output phase loss (0: Disable; 1: Enable) Bit 3: Select life judgment threshold of DC link bus capacitor (0: Factory default level; 1: User setup level) Bit 4: Judge the life of DC link bus capacitor (0: Disable; 1: Enable)	–	–	Y	Y	19 (decimal)	

(Note) Alphabets in the Default setting field denote shipping destination: A (Asia), C (China), E (Europe), and U (USA).

**A codes: Motor 2 Parameters**

Code	Name	Data setting range	Increment	Unit	Change when running	Data copying	Default setting (Note)	Refer to page:
A01	Maximum Frequency 2	25.0 to 400.0	0.1	Hz	N	Y	ACU:60.0 E:50.0	9-107
A02	Base Frequency 2	25.0 to 400.0	0.1	Hz	N	Y	AU:60.0 CE:50.0	
A03	Rated Voltage at Base Frequency 2	0: Output a voltage in proportion to input voltage 80 to 240V: Output an AVR-controlled voltage (for 200 V class series) *4 160 to 500V: Output an AVR-controlled voltage (for 400 V class series)	1	V	N	Y2	ACE:0 U:230/460	
A04	Maximum Output Voltage 2	80 to 240V: Output an AVR-controlled voltage (for 200 V class series) *4 160 to 500V: Output an AVR-controlled voltage (for 400 V class series)	1	V	N	Y2	A:220/380 C:200/380 E:230/400 U:230/460	
A05	Torque Boost 2	0.0% to 20.0% (percentage with respect to "A03: Rated Voltage at Base Frequency 2")	0.1	%	Y	Y	See Table A.	
A06	Electronic Thermal Overload Protection for Motor 2 (Motor characteristics)	1: For a general-purpose motor with shaft-driven cooling fan 2: For an inverter-driven motor with separately powered cooling fan	–	–	Y	Y	1	
A07	(Overload detection level)	0.00 (Disable), 0.01 to 100.0 1 to 135% of the rated current (allowable continuous drive current) of the motor	0.01	A	Y	Y1 Y2	See Table A.	
A08	(Thermal time constant)	0.5 to 75.0	0.1	min	Y	Y	5.0	
A09	DC Braking 2 (Braking starting frequency)	0.0 to 60.0	0.1	Hz	Y	Y	0.0	
A10	(Braking level)	0 to 100 *3	1	%	Y	Y	0	
A11	(Braking time)	0.00 : Disable 0.01 to 30.00	0.01	s	Y	Y	0.00	
A12	Starting Frequency 2	0.1 to 60.0	0.1	Hz	Y	Y	1.0	
A13	Load Selection/ Auto Torque Boost/ Auto Energy Saving Operation 2	0: Variable torque load 1: Constant torque load 2: Auto-torque boost 3: Auto-energy saving operation (Variable torque load during ACC/DEC) 4: Auto-energy saving operation (Constant torque load during ACC/DEC) 5: Auto-energy saving operation (Auto-torque boost during ACC/DEC)	–	–	N	Y	1	
A14	Control Mode Selection 2	0: V/f control with slip compensation inactive 1: Dynamic torque vector control 2: V/f control with slip compensation active	–	–	N	Y	0	
A16	Motor 2 (Rated capacity)	0.01 to 30.00 (kW when A39 = 0, 3, or 4) 0.01 to 30.00 (HP when A39 = 1)	0.01 0.01	kW HP	N	Y1 Y2	See Table A.	
A17	(Rated current)	0.00 to 100.0	0.01	A	N	Y1 Y2	Rated value of Fuji standard motor	
A18	(Auto-tuning)	0: Disable 1: Tune when the motor stops (%R1 and %X) 2: Tune when the motor is rotating under V/f control (%R1, %X, no-load current, slip frequency)	–	–	N	N	0	
A20	(No-load current)	0.00 to 50.0	0.01	A	N	Y1 Y2	Rated value of Fuji standard motor	

(Note) Alphabets in the Default setting field denote shipping destination: A (Asia), C (China), E (Europe), and U (USA).

\*3 For the single-phase 100 V class series, set the ratio relative to the reference current. Refer to Table B on page 9-19 for the reference current.

\*4 The setting for the 200 V class series applies also to the single-phase 100 V class series.

(A code continued)

Code	Name	Data setting range	Increment	Unit	Change when running	Data copying	Default setting (Note)	Refer to page:	
A21	Motor 2 (%R1)	0.00 to 50.00	0.01	%	Y	Y1 Y2	Rated value of Fuji standard motor	9-107	
A22	(%X)	0.00 to 50.00	0.01	%	Y	Y1 Y2	Rated value of Fuji standard motor		
A23	(Slip compensation gain for driving)	0.0 to 200.0	0.1	%	Y*	Y	100.0		
A24	(Slip compensation response time)	0.01 to 10.00	0.01	s	Y	Y1 Y2	1.00		9-108
A25	(Slip compensation gain for braking)	0.0 to 200.0	0.1	%	Y*	Y	100.0		
A26	(Rated slip frequency)	0.00 to 15.00	0.01	Hz	N	Y1 Y2	Rated value of Fuji standard motor		
A39	Motor 2 Selection	0: Motor characteristics 0 (Fuji standard IM, 8-series) 1: Motor characteristics 1 (HP rating IM) 3: Motor characteristics 3 (Fuji standard IM, 6-series) 4: Other motors (IM)	–	–	N	Y1 Y2	ACE:0 U:1		
A41	Output Current Fluctuation Damping Gain for Motor 2	0.00 to 0.40	0.01	–	Y	Y	0.20		
A51	Cumulative Run Time of Motor 2	0 to 9999 (in units of 10 hours)	–	–	N	N	–		
A52	Startup Counter for Motor 2	Indication of cumulative startup count (0000 to FFFF in hex.)	–	–	Y	N	–		

(Note) Alphabets in the Default setting field denote shipping destination: A (Asia), C (China), E (Europe), and U (USA).

**J codes: Application Functions**

Code	Name	Data setting range	Increment	Unit	Change when running	Data copying	Default setting (Note)	Refer to page:
J01	PID Control (Mode selection)	0: Disable 1: Enable (Process control, normal operation) 2: Enable (Process control, inverse operation)	—	—	N	Y	0	9-109
J02	(Remote command SV)	0: UP/DOWN keys on keypad 1: PID process command 1 (Analog input terminals [12] and [C1]) 3: Terminal command <b>UP/DOWN</b> control 4: Command via communications link	—	—	N	Y	0	
J03	P (Gain)	0.000 to 30.000 *1	0.001	times	Y	Y	0.100	
J04	I (Integral time)	0.0 to 3600.0 *1	0.1	s	Y	Y	0.0	
J05	D (Differential time)	0.00 to 600.00 *1	0.01	s	Y	Y	0.00	
J06	(Feedback filter)	0.0 to 900.0	0.1	s	Y	Y	0.5	
J15	(Operation level for slow flowrate stop)	0.0 (Disable), 1.0 to 400.0	0.1	Hz	Y	Y	0.0	9-115
J16	(Elapsed time from slow flowrate stop)	0 to 3600	1	s	Y	Y	30	
J17	(Initiation frequency)	0.0 to 400.0	0.1	Hz	Y	Y	0.0	
J23	(Initiation deviation level for slow flowrate stop)	0.0 to 100.0	0.1	%	Y	Y	0.0	
J24	(Start latency time for slow flowrate stop)	0 to 3660	1	s	Y	Y	0	
J68	Braking Signal (Brake OFF current)	0 to 200 *3	1	%	Y	Y	100	9-117
J69	(Brake OFF frequency)	0.0 to 25.0	0.1	Hz	Y	Y	1.0	
J70	(Brake OFF timer)	0.0 to 5.0	0.1	s	Y	Y	1.0	
J71	(Brake ON frequency)	0.0 to 25.0	0.1	Hz	Y	Y	1.0	
J72	(Brake ON timer)	0.0 to 5.0	0.1	s	Y	Y	1.0	

(Note) Alphabets in the Default setting field denote shipping destination: A (Asia), C (China), E (Europe), and U (USA).

\*1 When you make settings from the keypad, the incremental unit is restricted by the number of digits that the LED monitor can display.

(Example) If the setting range is from -200.00 to 200.00, the incremental unit is:

"1" for -200 to -100, "0.1" for -99.9 to -10.0 and for 100.0 to 200.0, and "0.01" for -9.99 to -0.01 and for 0.00 to 99.99.

\*3 For the single-phase 100 V class series, set the ratio relative to the reference current. Refer to Table B on page 9-19 for the reference current.

**y codes: Link Functions**

Code	Name	Data setting range	Increment	Unit	Change when running	Data copying	Default setting (Note)	Refer to page:
y01	RS-485 Communication 1 (Station address)	1 to 255	1	–	N	Y	1	9-119
y02	(Communications error processing)	0: Immediately trip with alarm $E-B$ 1: Trip with alarm $E-B$ after running for the period specified by timer y03 2: Retry during the period specified by timer y03. If the retry fails, trip with alarm $E-B$ . If it succeeds, continue to run. 3: Continue to run	–	–	Y	Y	0	
y03	(Timer)	0.0 to 60.0	0.1	s	Y	Y	2.0	
y04	(Baud rate)	0: 2400 bps 1: 4800 bps 2: 9600 bps 3: 19200 bps 4: 38400 bps	–	–	Y	Y	3	
y05	(Data length)	0: 8 bits 1: 7 bits	–	–	Y	Y	0	
y06	(Parity check)	0: None (2 stop bits for Modbus RTU) 1: Even parity (1 stop bit for Modbus RTU) 2: Odd parity (1 stop bit for Modbus RTU) 3: None (1 stop bit for Modbus RTU)	–	–	Y	Y	0	
y07	(Stop bits)	0: 2 bits 1: 1 bit	–	–	Y	Y	0	
y08	(No-response error detection time)	0: No detection 1 to 60	1	s	Y	Y	0	
y09	(Response interval)	0.00 to 1.00	0.01	s	Y	Y	0.01	
y10	(Protocol selection)	0: Modbus RTU protocol 1: SX protocol (FRENIC Loader protocol) 2: Fuji general-purpose inverter protocol	–	–	Y	Y	1	
y97	Communication Data Storage Selection *2	0: Save into nonvolatile storage (Rewritable times limited) 1: Write into temporary storage (Rewritable times unlimited) 2: Save all data from temporary storage to nonvolatile one (After saving data, the y97 data automatically reverts to "1.")	–	–	Y	Y	0	9-123
y99	Loader Link Function (Mode selection)	Frequency command      Run command 0: Follow H30 data      Follow H30 data 1: Via RS-485 link (Loader) Follow H30 data 2: Follow H30 data      Via RS-485 link (Loader) 3: Via RS-485 link (Loader) Via RS-485 link (Loader)	–	–	Y	N	0	

(Note) Alphabets in the Default setting field denote shipping destination: A (Asia), C (China), E (Europe), and U (USA).

\*2 Available in the ROM version 0500 or later.



Table A Fuji Standard Motor Parameters

Power supply voltage	Applicable motor rating kW (HP)	Inverter type	Fuji's standard torque boost (%)	Nominal rated current of Fuji standard motor (A)				Nominal rated capacity of Fuji standard motor (kW)	Restart mode after momentary power failure (Restart time)
				Function code F09/A05	Function codes F11/A07/E34/E37				Function code P02/A16
			Shipping destination (version)						
			Asia		China	Europe	USA		
Three-phase 200 V	0.1 (1/8)	FRN0001C2S-2□	8.4	0.62	0.68	0.73	0.63	0.10	0.5
	0.2 (1/4)	FRN0002C2S-2□	8.4	1.18	1.30	1.38	1.21	0.20	0.5
	0.4 (1/2)	FRN0004C2S-2□	7.1	2.10	2.30	2.36	2.11	0.40	0.5
	0.75 (1)	FRN0006C2S-2□	6.8	3.29	3.60	3.58	3.27	0.75	0.5
	1.5 (2)	FRN0010C2S-2□	6.8	5.56	6.10	5.77	5.44	1.50	0.5
	2.2 (3)	FRN0012C2S-2□	6.8	8.39	9.20	8.80	8.24	2.20	0.5
	3.7 (5)	FRN0020C2S-2□	5.5	13.67	15.00	14.26	13.40	3.70	0.5
	5.5 (7.5)	FRN0025C2S-2□	4.9	20.50	22.50	21.25	20.06	5.50	0.5
	7.5 (10)	FRN0033C2S-2□	4.4	26.41	29.00	26.92	25.72	7.50	0.5
	11 (15)	FRN0047C2S-2□	3.5	38.24	42.00	38.87	37.21	11.00	1.0
15 (20)	FRN0060C2S-2□	2.8	50.05	55.00	50.14	48.50	15.00	1.0	
Three-phase 400 V	0.4 (1/2)	FRN0002C2■-4□	7.1	1.04	1.15	1.15	1.06	0.40	0.5
	0.75 (1)	FRN0004C2■-4□	6.8	1.72	1.82	1.80	1.63	0.75	0.5
	1.5 (2)	FRN0005C2■-4□	6.8	3.10	3.20	3.10	2.76	1.50	0.5
	2.2 (3)	FRN0007C2■-4□	6.8	4.54	4.72	4.60	4.12	2.20	0.5
	3.7 (5)	FRN0011C2■-4□	5.5	7.43	7.70	7.50	6.70	3.70	0.5
	5.5 (7.5)	FRN0013C2■-4□	4.9	11.49	11.84	11.50	10.24	5.50	0.5
	7.5 (10)	FRN0018C2■-4□	4.4	14.63	15.00	14.50	12.86	7.50	0.5
	11 (15)	FRN0024C2■-4□	3.5	21.23	21.73	21.00	18.60	11.00	1.0
15 (20)	FRN0030C2■-4□	2.8	28.11	28.59	27.50	24.25	15.00	1.0	
Single-phase 200 V	0.1 (1/8)	FRN0001C2■-7□	8.4	0.62	0.68	0.73	0.63	0.10	0.5
	0.2 (1/4)	FRN0002C2■-7□	8.4	1.18	1.30	1.38	1.21	0.20	0.5
	0.4 (1/2)	FRN0004C2■-7□	7.1	2.10	2.30	2.36	2.11	0.40	0.5
	0.75 (1)	FRN0006C2■-7□	6.8	3.29	3.60	3.58	3.27	0.75	0.5
	1.5 (2)	FRN0010C2■-7□	6.8	5.56	6.10	5.77	5.44	1.50	0.5
	2.2 (3)	FRN0012C2■-7□	6.8	8.39	9.20	8.80	8.24	2.20	0.5
Single-phase 100 V	0.1 (1/8)	FRN0001C2S-6U	8.4	0.62	0.68	0.73	0.63	0.10	0.5
	0.2 (1/4)	FRN0002C2S-6U	8.4	1.18	1.30	1.38	1.21	0.20	0.5
	0.4 (1/2)	FRN0003C2S-6U	7.1	2.10	2.30	2.36	2.11	0.40	0.5
	0.75 (1)	FRN0005C2S-6U	6.8	3.29	3.60	3.58	3.27	0.75	0.5

Notes: A box (□) in the above table replaces A, C, E, or U depending on the shipping destination. For three-phase 200 V class series of inverters, it replaces A or U.

A box (■) in the above tables replaces S (Basic type) or E (EMC filter built-in type) depending on the enclosure.

Table B Reference Current for Single-phase 100 V Series

Applicable motor rating (HP)	Inverter type	Reference current
1/8	FRN0001C2S-6U	0.8
1/4	FRN0002C2S-6U	1.5
1/2	FRN0003C2S-6U	3.0
1	FRN0005C2S-6U	5.0

## 9.2 Details of Function Codes

This section provides the details of the function codes available for the FRENIC-Mini series of inverters. In each code group, its function codes are arranged in an ascending order of the identifying numbers for ease of access. However, highly relevant function codes are collectively described where one of them first appears.

### 9.2.1 F codes (Fundamental functions)

<b>F00</b>	<b>Data Protection</b>
------------	------------------------

F00 specifies whether to protect function code data (except F00) and digital reference data (such as frequency command, PID command and timer operation) from accidentally getting changed by pressing the  $\triangleleft$  /  $\triangleright$  keys.

Data for F00	Function
0	Disable both data protection and digital reference protection, allowing you to change both function code data and digital reference data with the $\triangleleft$ / $\triangleright$ keys.
1	Enable data protection and disable digital reference protection, allowing you to change digital reference data with the $\triangleleft$ / $\triangleright$ keys. But you cannot change function code data (except F00).
2	Disable data protection and enable digital reference protection, allowing you to change function code data with the $\triangleleft$ / $\triangleright$ keys. But you cannot change digital reference data.
3	Enable both data protection and digital reference protection, not allowing you to change function code data or digital reference data with the $\triangleleft$ / $\triangleright$ keys.

Enabling the protection disables the  $\triangleleft$  /  $\triangleright$  keys to change function code data.

To change F00 data, simultaneous keying of  $\text{STOP} + \triangleleft$  (from 0 to 1) or  $\text{STOP} + \triangleright$  (from 1 to 0) keys is required.



 Even when F00 = 1 or 3, function code data can be changed via the communications link.

For similar purposes, **WE-KP**, a signal enabling editing of function code data from the keypad is provided as a terminal command for digital input terminals. (Refer to the descriptions of E01 through E03.)

<b>F01</b>	<b>Frequency Command 1</b>	<b>C30 (Frequency Command 2)</b>
------------	----------------------------	----------------------------------

F01 or C30 sets the command source that specifies reference frequency 1 or reference frequency 2, respectively.

Data for F01, C30	Function
0	Enable $\triangleleft$ / $\triangleright$ keys on the keypad. (Refer to Chapter 3 "OPERATION USING THE KEYPAD.") The reference frequency can be seen in C99.
1	Enable the voltage input to terminal [12] (0 to +10 VDC, maximum frequency obtained at +10 VDC).

Data for F01, C30	Function
2	Enable the current input to terminal [C1] (+4 to +20 mA DC or 0 to +20 mA DC, maximum frequency obtained at +20 mA DC).  Using function code C40 expands the input range from "+4 to +20 mA DC" to "0 to +20 mA DC."
3	Enable the sum of voltage (0 to +10 VDC, maximum frequency obtained at +10 VDC) and current inputs (+4 to +20 mA DC or 0 to +20 mA DC, maximum frequency obtained at +20 mA DC) given to terminals [12] and [C1], respectively.  Using function code C40 expands the input range from "+4 to +20 mA DC" to "0 to +20 mA DC." Note: If the sum exceeds the maximum frequency (F03, A01), the maximum frequency will apply.
4	Enable the built-in potentiometer (POT). (Maximum frequency obtained at full scale of the POT)
7	Enable <b>UP</b> and <b>DOWN</b> commands assigned to digital input terminals. The <b>UP</b> and <b>DOWN</b> should be assigned to any of digital input terminals [X1] to [X3] beforehand with any of E01 to E03 (data = 17 and 18).







 • In addition to the frequency command sources described above, higher priority command sources including communications link and multistep frequency are provided. For more information, refer to the block diagram in Chapter 4, Section 4.2 "Drive frequency command generator."

 • For frequency settings made by terminals [12] (voltage) and [C1] (current) and by the built-in potentiometer, setting the gain and bias changes the relationship between those frequency settings and the drive frequency. Refer to function code F18 for details.

- For the inputs to terminals [12] (voltage) and [C1] (current), low-pass filters can be enabled. Refer to function codes C33 and C38.
- Using the terminal command **Hz2/Hz1** assigned to one of the digital input terminals switches between frequency command 1 (F01) and frequency command 2 (C30). Refer to function codes E01 to E03.

<b>F02</b>	<b>Operation Method</b>
------------	-------------------------

F02 selects the source that specifies a run command for running the motor.

Data for F02	Description
0: Keypad (Rotation direction specified by terminal command)	Enable the  /  keys to run and stop the motor. The rotation direction of the motor is specified by terminal command <b>FWD</b> or <b>REV</b> .
1: External signals (Digital input terminal commands)	Enable terminal command <b>FWD</b> or <b>REV</b> to run and stop the motor.
2: Keypad (Forward rotation)	Enable  /  keys to run and stop the motor. Note that this run command enables only the forward rotation. There is no need to specify the rotation direction.
3: Keypad (Reverse rotation)	Enable  /  keys to run and stop the motor. Note that this run command enables only the reverse rotation. There is no need to specify the rotation direction.

- Note**
- When function code F02 = 0 or 1, the "Run forward" *FWD* and "Run reverse" *REV* terminal commands must be assigned to terminals [FWD] and [REV], respectively.
  - When the *FWD* or *REV* is ON, the F02 data cannot be changed.
  - When assigning the *FWD* or *REV* to terminal [FWD] or [REV] with F02 being set to "1," be sure to turn the target terminal OFF beforehand; otherwise, the motor may unintentionally rotate.
  - In addition to the run command sources described above, higher priority command sources including communications link are provided.

<b>F03</b>	<b>Maximum Frequency 1</b>	<b>A01 (Maximum Frequency 2)</b>
------------	----------------------------	----------------------------------

F03 specifies the maximum frequency (for motor 1) to limit the output frequency. Specifying the maximum frequency exceeding the rating of the equipment driven by the inverter may cause damage or a dangerous situation. Make sure that the maximum frequency setting matches the equipment rating.

<b>⚠ CAUTION</b>
The inverter can easily accept high-speed operation. When changing the speed setting, carefully check the specifications of motors or equipment beforehand. <b>Otherwise injuries could occur.</b>

- Note** Modifying F03 data to allow a higher output frequency requires also changing F15 data specifying a frequency limiter (high).

<b>F04</b>	<b>Base Frequency 1</b>	<b>H50 (Non-linear V/f Pattern 1, Frequency) A02 (Base Frequency 2)</b>
<b>F05</b>	<b>Rated Voltage at Base Frequency 1</b>	<b>H51 (Non-linear V/f Pattern 1, Voltage) A03 (Rated Voltage at Base Frequency 2)</b>
<b>F06</b>	<b>Maximum Output Voltage 1</b>	<b>H52 (Non-linear V/f Pattern 2, Frequency) H53 (Non-linear V/f Pattern 2, Voltage) A04 (Maximum Output Voltage 2)</b>

These function codes specify the base frequency and the voltage at the base frequency essentially required for running the motor properly. If combined with the related function codes H50 through H53, these function codes may profile the non-linear V/f pattern by specifying increase or decrease in voltage at any point on the V/f pattern.

The following description includes setups required for the non-linear V/f pattern.

At high frequencies, the motor impedance may increase, resulting in an insufficient output voltage and a decrease in output torque. This feature is used to increase the voltage with the maximum output voltage 1 to prevent this problem from happening. Note, however, that you cannot increase the output voltage beyond the voltage of the inverter's input power.

■ **Base Frequency 1 (F04)**

Set the rated frequency printed on the nameplate labeled on the motor.

■ **Rated Voltage at Base Frequency (F05)**

Set "0" or the rated voltage printed on the nameplate labeled on the motor.

- If "0" is set, the rated voltage at base frequency is determined by the power source of the inverter. The output voltage will vary in line with any variance in input voltage.
- If the data is set to anything other than "0," the inverter automatically keeps the output voltage constant in line with the setting. When any of the auto torque boost settings, auto energy saving or slip compensation is active, the voltage settings should be equal to the rated voltage of the motor.

- Non-linear V/f Patterns 1 and 2 for Frequency (H50 and H52)  
Set the frequency component at an arbitrary point of the non-linear V/f pattern.  
(Setting "0.0" to H50 or H52 disables the non-linear V/f pattern operation.)
- Non-linear V/f Patterns 1 and 2 for Voltage (H51 and H53)  
Sets the voltage component at an arbitrary point of the non-linear V/f pattern.
- Maximum Output Voltage (F06)  
Set the voltage for the maximum frequency 1 (F03).

**Note**

- If F05 (Rated Voltage at Base Frequency 1) is set to "0," settings of H50 through H53 and F06 do not take effect. (When the non-linear point is below the base frequency, the linear V/f pattern applies; when it is above, the output voltage is kept constant.)
- When the auto torque boost (F37) is enabled, the non-linear V/f pattern takes no effect.

**Examples:**

■ Normal (linear) V/f pattern

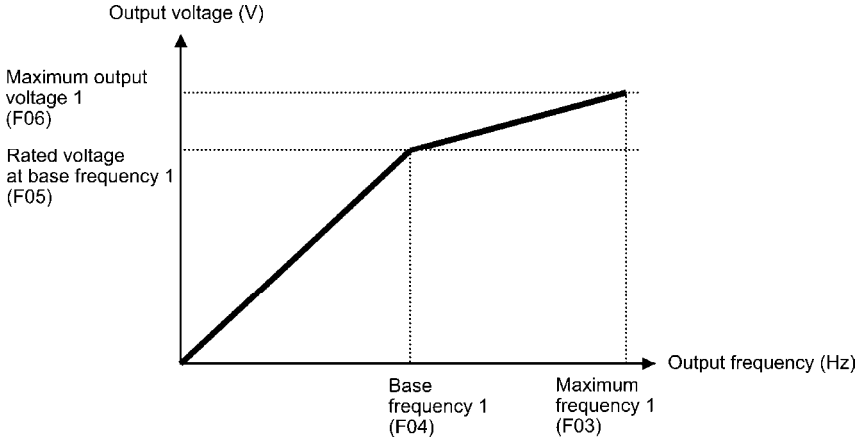

■ V/f pattern with two non-linear points

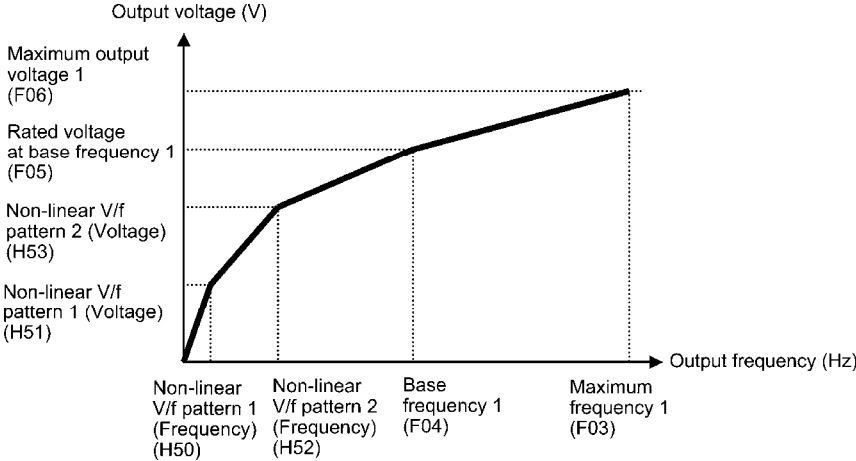

<b>F07</b>	<b>Acceleration Time 1</b>	<b>E10 (Acceleration Time 2)</b>
<b>F08</b>	<b>Deceleration Time 1</b>	<b>E11 (Deceleration Time 2)</b>

F07 specifies the acceleration time, the length of time the frequency increases from 0 Hz to the maximum frequency. F08 specifies the deceleration time, the length of time the frequency decreases from the maximum frequency down to 0 Hz.

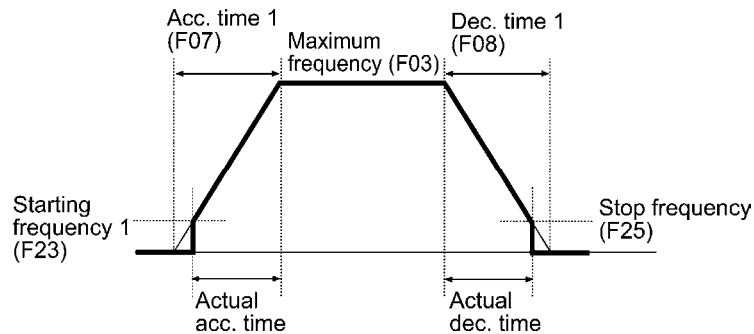

- Note**
- Selecting an S-shaped pattern or curvilinear acceleration/deceleration pattern with function code H07 (Acceleration/deceleration pattern) makes the actual acceleration/deceleration times longer than the specified ones. Refer to the descriptions of function code H07.
  - Specifying an improperly short acceleration/deceleration time may activate the current limiter or anti-regenerative control, resulting in a longer acceleration/deceleration time than the specified one.
- Tip** Acceleration/deceleration time 1 (F07, F08) and acceleration/deceleration time 2 (E10, E11) are switched by terminal command **RTI** assigned to any of the digital input terminals with any of function codes E01 through E03.

<b>F09</b>	<b>Torque Boost 1</b>	<b>F37 (Load Selection/Auto Torque Boost/Auto Energy Saving Operation 1) A05 (Torque Boost 2)</b>
------------	-----------------------	---

F37 specifies V/f pattern, torque boost type, and auto energy saving operation for optimizing the operation in accordance with the characteristics of the load. F09 specifies the type of torque boost in order to provide sufficient starting torque.

Data for F37	V/f pattern	Torque boost (F09)	Auto energy saving	Applicable load
0	Variable torque V/f pattern	Torque boost specified by F09	Disable	Variable torque load (General purpose fans and pumps)
1	Linear V/f pattern	Auto torque boost		Constant torque load
2			Constant torque load (To be selected if a motor may be over-excited at no load.)	
3	Variable torque V/f pattern	Torque boost specified by F09	Enable	Variable torque load (General purpose fans and pumps)
4	Linear V/f pattern	Auto torque boost		Constant torque load
5				Constant torque load (To be selected if a motor may be over-excited at no load.)

**Note:** If a required "load torque + acceleration torque" is more than 50% of the rated torque, it is recommended to select the linear V/f pattern (factory default).

■ V/f characteristics

The FRENIC-Mini series of inverters offers a variety of V/f patterns and torque boosts, which include V/f patterns suitable for variable torque load such as general fans and pumps or for special pump load requiring high starting torque. Two types of torque boost are available: manual and automatic.

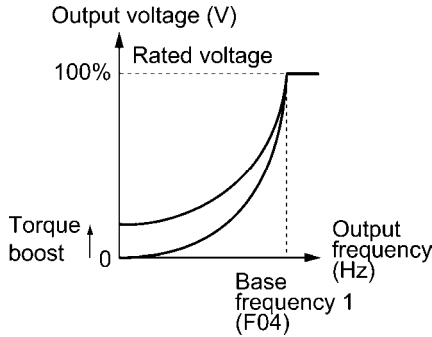

Variable torque V/f pattern (F37 = 0)

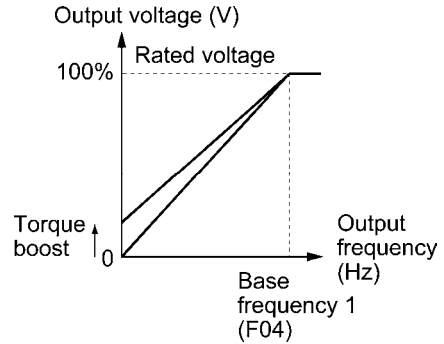

Linear V/f pattern (F37 = 1)

**Tip** When the variable torque V/f pattern is selected (F37 = 0 or 3), the output voltage may be low and insufficient voltage output may result in less output torque of the motor at a low frequency zone, depending on some characteristics of the motor itself and load. In such a case, it is recommended to increase the output voltage at the low frequency zone using the non-linear V/f pattern (H50, H51).

Recommended value: H50 = 1/10 of the base frequency  
 H51 = 1/10 of the voltage at base frequency

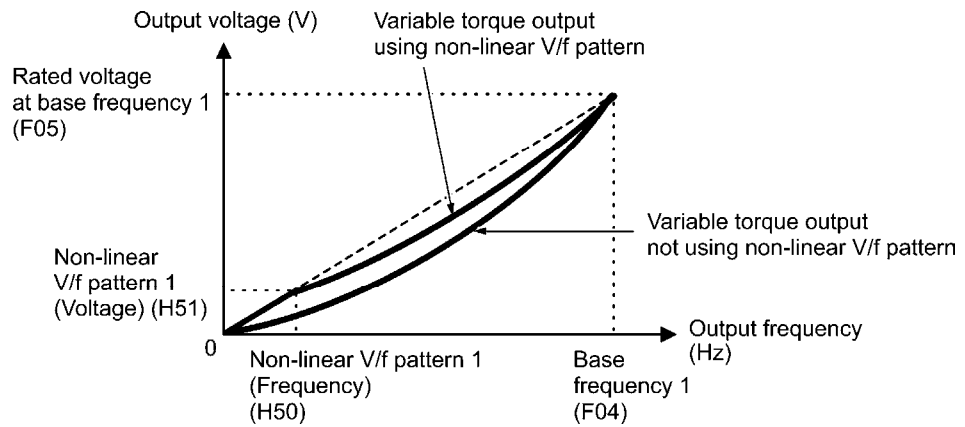

## ■ Torque boost

### • Manual torque boost (F09)

In torque boost using F09, constant voltage is added to the basic V/f pattern, regardless of the load, to give the output voltage. To secure a sufficient starting torque, manually adjust the output voltage to optimally match the motor and its load by using F09. Specify an appropriate level that guarantees smooth start-up and yet does not cause over-excitation with no or light load.

Torque boost per F09 ensures high driving stability since the output voltage remains constant regardless of the load fluctuation.

Specify the F09 data in percentage to the rated voltage at base frequency 1 (F05). At factory shipment, F09 is preset to a level that provides approx. 100% of starting torque.

**Note** Specifying a high torque boost level will generate a high torque, but may cause overcurrent due to over-excitation at no load. If you continue to drive the motor, it may overheat. To avoid such a situation, adjust torque boost to an appropriate level. When the non-linear V/f pattern and the torque boost are used together, the torque boost takes effect below the frequency on the non-linear V/f pattern's point.

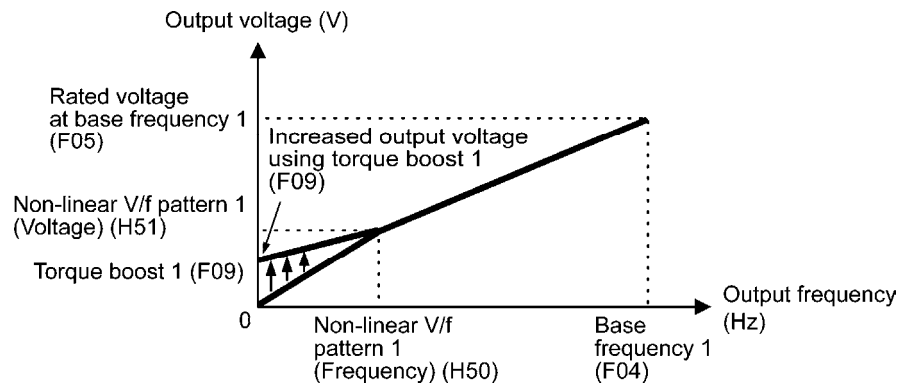

### • Auto torque boost

This function automatically optimizes the output voltage to fit the motor with its load. Under light load, auto torque boost decreases the output voltage to prevent the motor from over-excitation. Under heavy load, it increases the output voltage to increase output torque of the motor.

**Note**

- Since this function relies also on the characteristics of the motor, set the base frequency 1 (F04), the rated voltage at base frequency 1 (F05), and other pertinent motor parameters (P02, P03 and P06 through P99) in line with the motor capacity and characteristics, or else perform auto-tuning (P04).
- When a special motor is driven or the load does not have sufficient rigidity, the maximum torque might decrease or the motor operation might become unstable. In such cases, do not use auto torque boost but choose manual torque boost per F09 (F37 = 0 or 1).



■ Auto energy saving operation

This feature automatically controls the supply voltage to the motor to minimize the total power loss of motor and inverter. (Note that this feature may not be effective depending upon the motor or load characteristics. Check the advantage of energy saving before actually apply this feature to your power system.)

This feature applies to constant speed operation only. During acceleration/deceleration, the inverter will run with manual torque boost (F09) or auto torque boost, depending on the F37 data. If auto energy saving operation is enabled, the response to a change in motor speed may be slow. Do not use this feature for such a system that requires quick acceleration/deceleration.

- Note**
- Use auto energy saving only where the base frequency is 60 Hz or lower. If the base frequency is set at 60 Hz or higher, you may get a little or no energy saving advantage. The auto energy saving operation is designed for use with the frequency lower than the base frequency. If the frequency becomes higher than the base frequency, the auto energy saving operation will be invalid.
  - Since this function relies also on the characteristics of the motor, set the base frequency 1 (F04), the rated voltage at base frequency 1 (F05), and other pertinent motor parameters (P02, P03 and P06 through P99) in line with the motor capacity and characteristics, or else perform auto-tuning (P04).

<b>F10</b>	<b>Electronic Thermal Overload Protection for Motor 1 (Select motor characteristics)</b> <b>A06 (Electronic Thermal Overload Protection for Motor 2, Select motor characteristics)</b>
<b>F11</b>	<b>Electronic Thermal Overload Protection for Motor 1 (Overload detection level)</b> <b>A07 (Electronic Thermal Overload Protection for Motor 2, Overload detection level)</b>
<b>F12</b>	<b>Electronic Thermal Overload Protection for Motor 1 (Thermal time constant)</b> <b>A08 (Electronic Thermal Overload Protection for Motor 2, Thermal time constant)</b>

F10 through F12 specify the thermal characteristics of the motor for its electronic thermal overload protection that is used to detect overload conditions of the motor.

F10 selects the motor cooling mechanism to specify its characteristics, F11 specifies the overload detection current, and F12 specifies the thermal time constant.

- Note** Thermal characteristics of the motor specified by F10 and F12 are also used for the overload early warning. Even if you need only the overload early warning, set these characteristics data to these function codes. To disable the electronic thermal overload protection, set function code F11 to "0.00."

■ Motor characteristics (F10)

F10 selects the cooling mechanism of the motor--shaft-driven or separately powered cooling fan.

Data for F10	Function
1	For a general-purpose motor and Fuji standard permanent magnet synchronous motor with shaft-driven cooling fan. (The cooling effect will decrease in low frequency operation.)
2	For an inverter-driven motor with separately powered cooling fan. (The cooling effect will be kept constant regardless of the output frequency.)

The figure below shows operating characteristics of the electronic thermal overload protection when F10 = 1. The characteristic factors  $\alpha_1$  through  $\alpha_3$  as well as their corresponding output frequencies  $f_2$  and  $f_3$  vary with the characteristics of the motor.

The tables below list the factors determined by the motor capacity (P02) and the motor characteristics (P99).

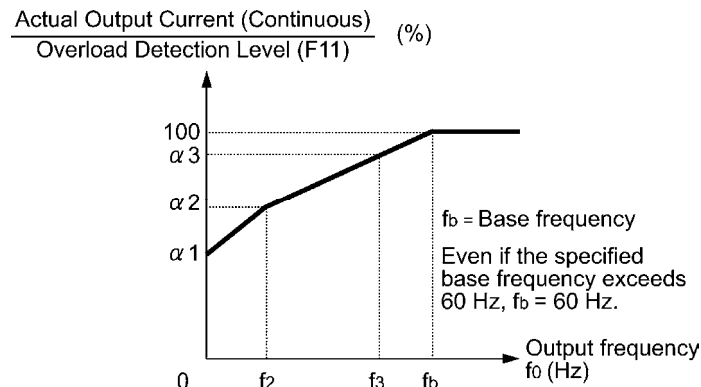

Nominal Applied Motor and Characteristic Factors when P99 (Motor 1 Selection) = 0 or 4

Nominal applied motor kW (HP)	Thermal time constant $\tau$ (Factory default)	Reference current for setting the thermal time constant ( $I_{max}$ )	Output frequency for motor characteristic factor		Characteristic factor		
			$f_2$	$f_3$	$\alpha_1$	$\alpha_2$	$\alpha_3$
0.1 to 0.75 (1/8 to 1)	5 min	Allowable continuous current $\times 150\%$	5 Hz	7 Hz	75%	85%	100%
1.5 to 4.0 (2 to 5)					85%	85%	100%
5.5 to 11 (7.5 to 15)				6 Hz	90%	95%	100%
15 (20)				7 Hz	85%	85%	100%
18.5 (25), 22 (30)				5 Hz	92%	100%	100%
30 (40)	10 min		Base frequency $\times 33\%$	Base frequency $\times 33\%$	54%	85%	90%

Nominal Applied Motor and Characteristic Factors when P99 (Motor 1 Selection) = 1 or 3

Nominal applied motor kW (HP)	Thermal time constant $\tau$ (Factory default)	Reference current for setting the thermal time constant ( $I_{max}$ )	Output frequency for motor characteristic factor		Characteristic factor		
			$f_2$	$f_3$	$\alpha_1$	$\alpha_2$	$\alpha_3$
0.1 to 22 (1/8 to 30)	5 min	Allowable continuous current $\times 150\%$	Base frequency $\times 33\%$	Base frequency $\times 33\%$	69%	90%	90%
30 (40)	10 min			Base frequency $\times 83\%$	54%	85%	95%

When F10 = 2, the cooling effect is not decreased by the output frequency so that the overload detection level is a constant value without reduction (F11).

■ Overload detection level (F11)

F11 specifies the detection level (in amperes) at which the electronic thermal overload protection becomes activated.

In general, set the F11 data to the allowable continuous current of motor when driven at the base frequency (i.e. 1.0 to 1.1 times of the rated current of the motor). To disable the electronic thermal overload protection, set the F11 data to "0.00."

■ Thermal time constant (F12)

F12 specifies the thermal time constant of the motor. If the current of 150% of the overload detection level specified by F11 flows for the time specified by F12, the electronic thermal overload protection becomes activated to detect the motor overload. The thermal time constant for general-purpose motors including Fuji motors is approx. 5 minutes by factory default.

- Data setting range: 0.5 to 75.0 (minutes) in increments of 0.1 (minute)

(Example) When the F12 data is set at "5.0" (5 minutes)

As shown below, the electronic thermal overload protection is activated to detect an alarm condition (alarm code  $\overline{OL}$  / ) when the output current of 150% of the overload detection level (specified by F11) flows for 5 minutes, and 120% for approx. 12.5 minutes.

The actual time required for issuing a motor overload alarm tends to be shorter than the specified value, taking into account the time period from when the output current exceeds the allowable continuous drive current (100%) until it reaches 150% of the overload detection level.

Example of Thermal Overload Detection Characteristics

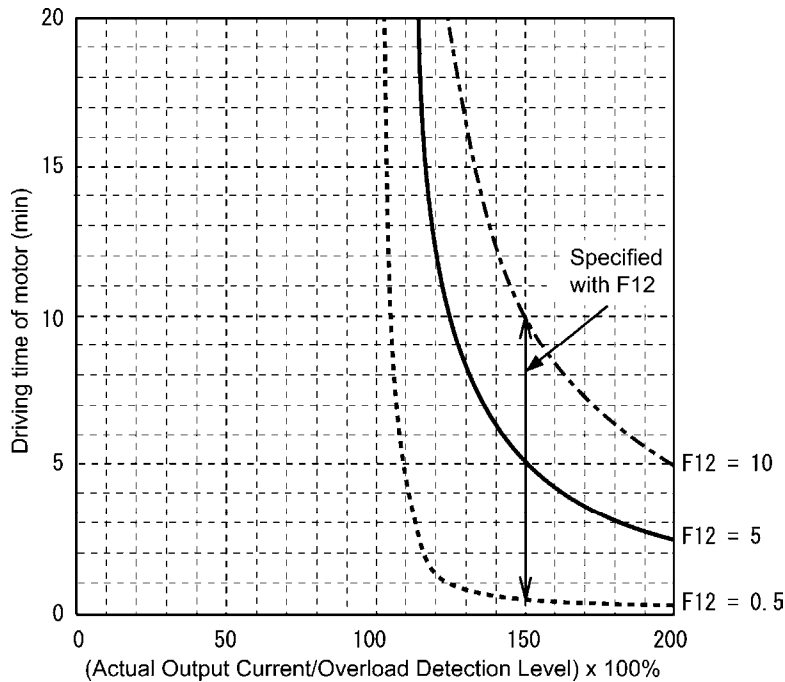

<b>F14</b>	<b>Restart Mode after Momentary Power Failure (Mode selection)</b> <b>H13 (Restart time)</b> <b>H14 (Frequency fall rate)</b> <b>H15 (Continuous running level)</b> <b>H92 (Continuity of Running, P)</b> <b>H93 (Continuity of Running, I)</b>
------------	--

F14 specifies the action to be taken by the inverter such as trip and restart in the event of a momentary power failure.

■ Restart mode after momentary power failure (Mode selection) (F14)

Data for F14	Description
0: Disable restart (Trip immediately)	As soon as the DC link bus voltage drops below the undervoltage level due to a momentary power failure, the inverter issues undervoltage alarm $\angle\angle\prime$ and shuts down its output so that the motor enters a coast-to-stop state.
1: Disable restart (Trip after recovery from power failure)	As soon as the DC link bus voltage drops below the undervoltage level due to a momentary power failure, the inverter shuts down its output so that the motor enters a coast-to-stop state, but it does not enter the undervoltage state or issue undervoltage alarm $\angle\angle\prime$ .  The moment the power is restored, an undervoltage alarm $\angle\angle\prime$ is issued.
2: Trip after decelerate-to-stop	As soon as the DC link bus voltage drops below the continuous running level due to a momentary power failure, decelerate-to-stop control is invoked. Decelerate-to-stop control regenerates kinetic energy from the load's moment of inertia, slowing down the motor and continuing the deceleration operation. After decelerate-to-stop operation, an undervoltage alarm $\angle\angle\prime$ is issued.  (Available in the ROM version 0500 or later.)
4: Enable restart (Restart at the frequency at which the power failure occurred, for general loads)	As soon as the DC link bus voltage drops below the undervoltage level due to a momentary power failure, the inverter saves the output frequency being applied at that time and shuts down the output so that the motor enters a coast-to-stop state.  If a run command has been input, restoring power restarts the inverter at the output frequency saved during the last power failure processing.  This setting is ideal for applications with a moment of inertia large enough not to slow down the motor quickly, such as fans, even after the motor enters a coast-to-stop state upon occurrence of a momentary power failure.
5: Enable restart (Restart at the starting frequency, for low-inertia load)	After a momentary power failure, restoring power and then entering a run command restarts the inverter at the starting frequency specified by function code F23.  This setting is ideal for heavy load applications such as pumps, having a small moment of inertia, in which the motor speed quickly goes down to zero as soon as it enters a coast-to-stop state upon occurrence of a momentary power failure.

**⚠ WARNING**

If you enable the "Restart mode after momentary power failure" (Function code F14 = 4 or 5), the inverter automatically restarts the motor running when the power is restored. Design the machinery or equipment so that human safety is ensured after restarting.

**Otherwise an accident could occur.**

### ■ Restart mode after momentary power failure (Basic operation)

The inverter recognizes a momentary power failure upon detecting the condition that DC link bus voltage goes below the undervoltage level, while the inverter is running. If the load of the motor is light and the duration of the momentary power failure is extremely short, the voltage drop may not be great enough for a momentary power failure to be recognized, and the motor may continue to run uninterrupted.

Upon recognizing a momentary power failure, the inverter enters the restart mode (after a recovery from momentary power failure) and prepares for restart. When power is restored, the inverter goes through an initial charging stage and enters the ready-to-run state. When a momentary power failure occurs, the power supply voltage for external circuits such as relay sequence circuits may also drop so as to turn the run command off. In consideration of such a situation, the inverter waits 2 seconds for a run command input after the inverter enters a ready-to-run state. If a run command is received within 2 seconds, the inverter begins the restart processing in accordance with the F14 data (Mode selection). If no run command has been received within 2-second wait period, the inverter cancels the restart mode (after a recovery from momentary power failure) and needs to be started again from the ordinary starting frequency. Therefore, ensure that a run command is entered within 2 seconds after a recovery of power, or install a mechanical latch relay.

When run commands are entered via the keypad, the above operation is also necessary for the mode (F02 = 0) in which the rotational direction is determined by the terminal command, **FWD** or **REV**. In the modes where the rotational direction is fixed (F02 = 2 or 3), it is retained inside the inverter so that the restart will begin as soon as the inverter enters the ready-to-run state.

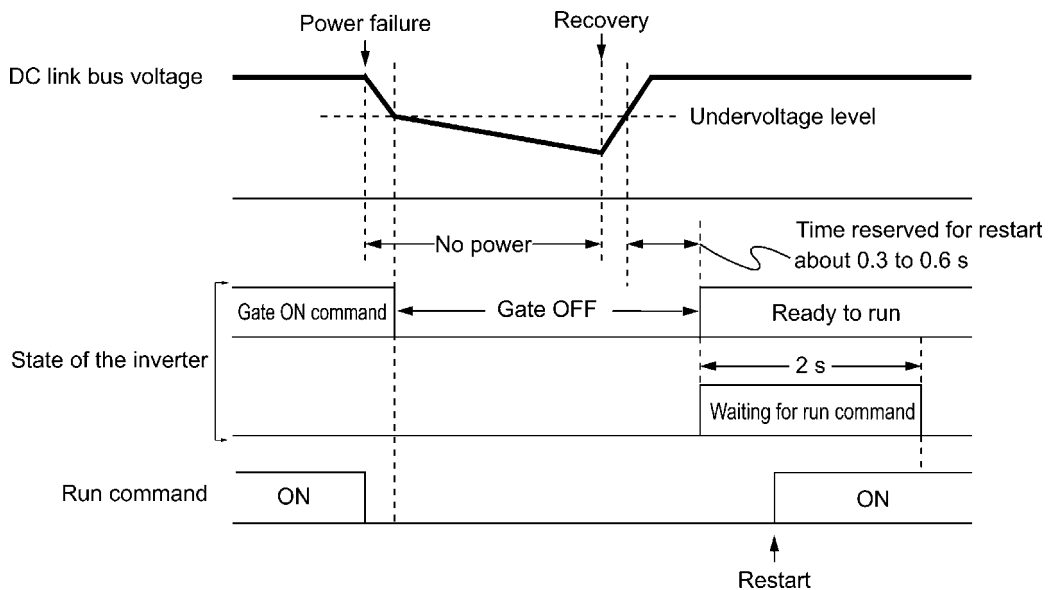

**Note** If the "Coast to a stop" terminal command **BX** is entered during the power failure, the inverter gets out of the restart mode and enters the normal running mode. If a run command is entered with power supply applied, the inverter will start from the normal starting frequency (F23).

During a momentary power failure, the motor slows down. After power is restored, the inverter restarts at the frequency just before the momentary power failure. Then, the current limiting function works and the output frequency of the inverter automatically decreases. When the output frequency matches the motor speed, the motor accelerates up to the original output frequency. See the figure below. In this case, the instantaneous overcurrent limiting must be enabled (H12 = 1).

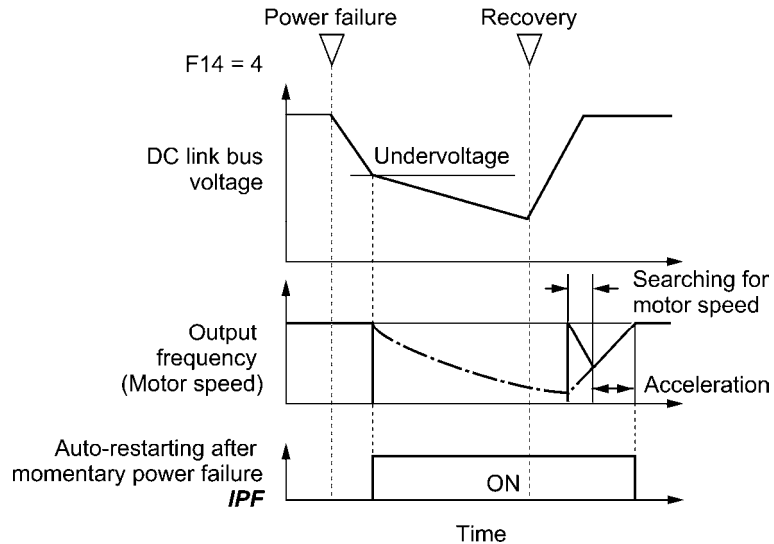

■ Restart mode after momentary power failure (Restart time) (H13)

H13 specifies the time period from momentary power failure occurrence until the inverter reacts for restarting process.

If the inverter starts the motor while motor's residual voltage is still in a high level, a large inrush current may flow or an overvoltage alarm may occur due to an occurrence of temporary regeneration. For safety, therefore, it is advisable to set H13 to a certain level so that restart will take place only after the residual voltage has dropped to a low level. Note that even when power is restored, restart will not take place until the restart time (H13) has elapsed.

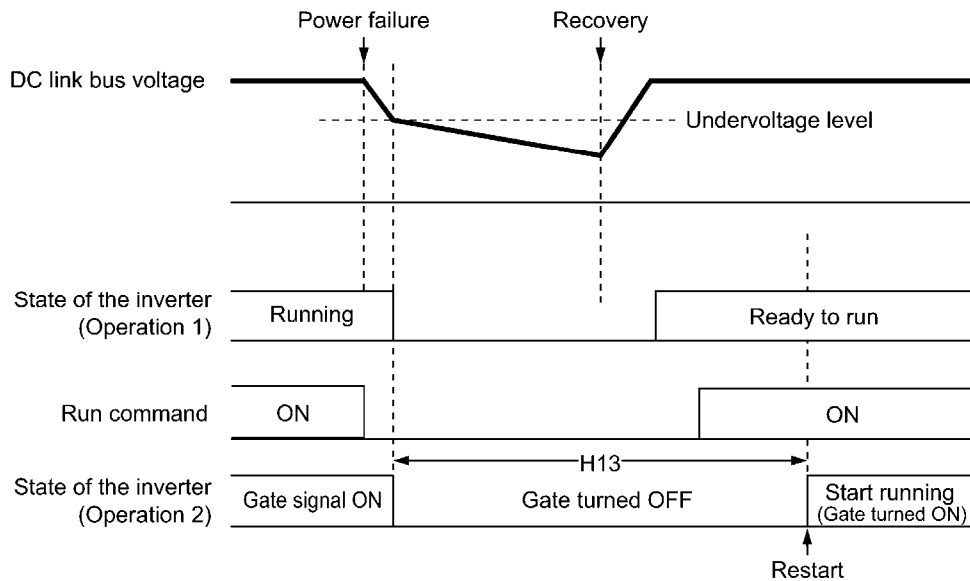

**Factory default**

By factory default, H13 is set at one of the values shown below according to the inverter capacity. Basically, you do not need to change H13 data. However, if the long restart time causes the flow rate of the pump to overly decrease or causes any other problem, you might as well reduce the setting to about a half of the default value. In such a case, make sure that no alarm occurs.

Inverter capacity kW (HP)	Factory default of H13 (Restart Mode after Momentary Power Failure (Restart time))
0.1 to 7.5 (1/8 to 10)	0.5 (seconds)
11 to 15 (15 to 20)	1.0 (seconds)

■ Restart mode after momentary power failure (Frequency fall rate) (H14)

During restart after a momentary power failure, if the inverter output frequency and the idling motor speed cannot be harmonized with each other, an overcurrent will flow, activating the overcurrent limiter. If it happens, the inverter automatically reduces the output frequency to match the idling motor speed according to the reduction rate (Frequency fall rate: Hz/s) specified by H14.

Data for H14	Inverter's action for the output frequency fall
0.00	Follow the specified deceleration time
0.01 to 100.00 (Hz/s)	Follow data specified by H14
999	Follow the setting of the PI processor in the current limiter (of the current limit control block shown in Figure 4.3.1 in Section 4.4). (The PI constant is prefixed inside the inverter.)

**Note** If the frequency fall rate is too high, regeneration may take place at the moment the motor rotation matches the inverter output frequency, causing an overvoltage trip. On the contrary, if the frequency fall rate is too low, the time required for the output frequency to match the motor speed (duration of current limiting action) may be prolonged, triggering the inverter overload prevention control.

■ Restart after momentary power failure (Continuous running level) (H15)

Continuity of running (P and I) (H92, H93)

- Trip after decelerate-to-stop (F14 = 2)

If a momentary power failure occurs when F14 is set to "2" (Trip after decelerate-to-stop), the inverter enters the control sequence of the decelerate-to-stop when the DC link bus voltage drops below the continuous running level specified by H15.

Under the decelerate-to-stop control, the inverter decelerates its output frequency keeping the DC link bus voltage constant using the PI processor. P (proportional) and I (integral) components of the PI processor are specified by H92 and H93, respectively.

For normal inverter operation, it is not necessary to modify data of H15, H92 or H93.

**Note** Even if you select "Trip after decelerate-to-stop", the inverter may not be able to do so when the load's inertia is small or the load is heavy, due to undervoltage caused by a control delay. In such a case, when "Trip after decelerate-to-stop" is selected, the inverter allows the motor to coast to a stop.

When the input power voltage for the inverter is high, setting the continuous running level high makes the control more stable even if the load's inertia is relatively small. Raising the continuous running level too high, however, might cause the continuous running control activated even during normal operation.

**Note** When the input power voltage for the inverter is extremely low, continuous running control might be activated even during normal operation, at the beginning of acceleration or at an abrupt change in load. To avoid this, lower the continuous running level. Lowering it too low, however, might cause undervoltage that results from voltage drop due to a control delay.

Before you change the continuous running level, make sure that the continuous running control will be performed properly, by considering the fluctuations of the load and the input voltage.

<b>F15</b>	<b>Frequency Limiter (High)</b>	
<b>F16</b>	<b>Frequency Limiter (Low)</b>	<b>H63 (Low Limiter, Mode selection)</b>

F15 and F16 specify the upper and lower limits of the output frequency, respectively.

H63 specifies the operation to be carried out when the output frequency drops below the low level specified by F16, as follows:

- When H63 = 0, the output frequency will be held at the low level specified by F16.
  - When H63 = 1, the inverter decelerates to stop the motor.
- Data setting range: 0.0 to 400.0 Hz

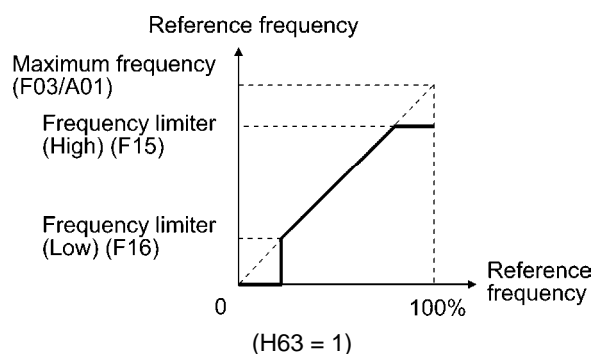
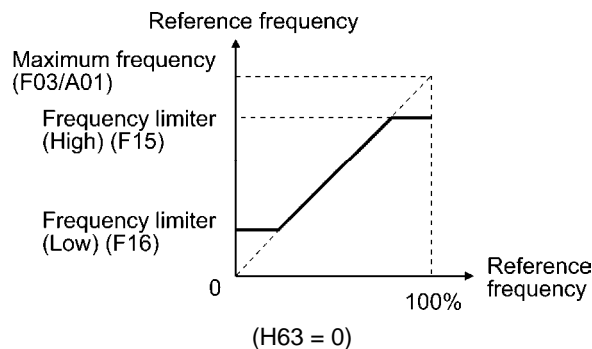

- Note**
- When you change the frequency limiter (High) (F15) in order to raise the reference frequency, be sure to change the maximum frequency (F03, A01) accordingly.
  - Maintain the following relationship among the data for frequency control:  
 $F15 > F16$ ,  $F15 > F23(A12)$ , and  $F15 > F25$   
 $F03/A01 > F16$

where, F23(A12) is of the starting frequency and F25 is of the stop frequency.

If you specify any wrong data for these function codes, the inverter may not run the motor at the desired speed, or cannot start it normally.



<b>F18</b>	<b>Bias (Frequency command 1)</b>	<b>C50, C32, C34, C37 and C39 (Bias base point, Gain, and Gain base point)</b>
------------	-----------------------------------	--

When any analog input for frequency command 1 (F01) is used, it is possible to define the relationship between the analog input and the reference frequency by multiplying the gain and adding the bias specified by F18.

Analog input	Gain		Bias	
	Function code	Data setting range (%)	Function code	Data setting range (%)
Terminal [12]	C32: Gain	0.00 to 200.00	F18: Bias	-100.00 to 100.00
	C34: Gain base point	0.00 to 100.00		
Terminal [C1]	C37: Gain	0.00 to 200.00	C50: Bias base point	0.00 to 100.00
	C39: Gain base point	0.00 to 100.00		

As shown in the graph below, the relationship between the analog input and the reference frequency specified by frequency command 1 is determined by points "A" and "B." Point "A" is defined by the combination of the bias (F18) and its base point (C50); Point "B," by the combination of the gain (C32, C37) and its base point (C34, C39).

The combination of C32 and C34 applies to terminal [12] and that of C37 and C39, to terminal [C1].

Configure the bias (F18) and gain (C32, C37), assuming the maximum frequency as 100%, and the bias base point (C50) and gain base point (C34, C39), assuming the full scale (10 VDC or 20 mA DC) of analog input as 100%.

- Note**
- The analog input less than the bias base point (C50) is limited by the bias value (F18).
  - Specifying that the data of the bias base point (C50) is equal to or greater than that of each gain base point (C34, C39) will be interpreted as invalid, so the inverter will reset the reference frequency to 0 Hz.

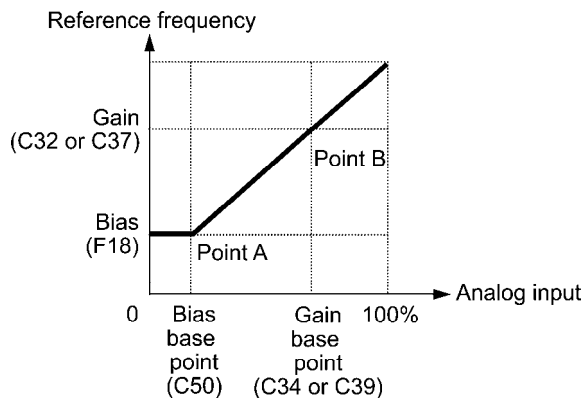

---

**Example:** Setting the bias, gain and their base points when the reference frequency 0 to 100% follows the analog input of 1 to 5 VDC to terminal [12] (in frequency command 1).

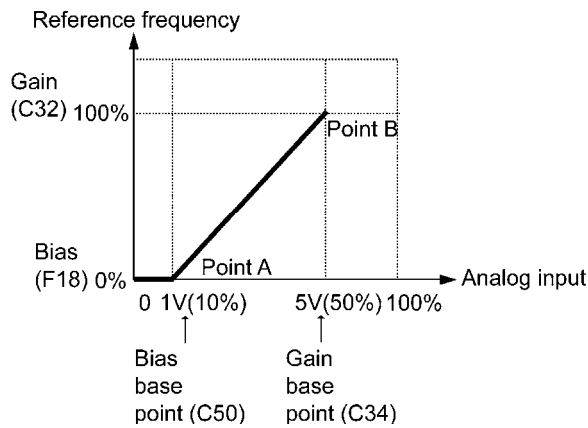

(Point A)

To set the reference frequency to 0 Hz for an analog input being at 1 V, set the bias to 0% (F18 = 0). Since 1 V is the bias base point and it is equal to 10% of 10 V (full scale), set the bias base point to 10% (C50 = 10).

(Point B)

To make the maximum frequency equal to the reference frequency for an analog input being at 5 V, set the gain to 100% (C32 = 100). Since 5 V is the gain base point and it is equal to 50% of 10 V (full scale), set the gain base point to 50% (C34 = 50).

**Note** The setting procedure for specifying a gain or bias alone without changing any base points is the same as that of Fuji conventional inverters.

<b>F20</b>	<b>DC Braking 1 (Braking starting frequency)</b> H95 (DC Braking, Braking response mode) A09 (DC Braking 2, Braking starting frequency)	
<b>F21</b>	<b>DC Braking 1 (Braking level)</b>	<b>A10 (DC Braking 2, Braking level)</b>
<b>F22</b>	<b>DC Braking 1 (Braking time)</b>	<b>A11 (DC Braking 2, Braking time)</b>

F20 through F22 specify the DC braking that prevents motor 1 from running by inertia during decelerate-to-stop operation.

If the motor enters a decelerate-to-stop operation by turning off the run command or by decreasing the reference frequency below the stop frequency, the inverter activates the DC braking by flowing a current at the braking level (F21) during the braking time (F22) when the output frequency reaches the DC braking starting frequency (F20).

Setting the braking time (F22) to "0.00" disables the DC braking.

■ **Braking starting frequency (F20)**

F20 specifies the frequency at which the DC braking starts its operation during motor decelerate-to-stop state.

■ **Braking level (F21)**

F21 specifies the output current level to be applied when the DC braking is activated. The function code data should be set, assuming the rated output current of the inverter as 100%, in increments of 1%.

**Note** For the single-phase 100 V class series, the braking level should be calculated based on the reference current as shown below.

Inverter type: FRN_ _ _ _C2S-6U	0001	0002	0003	0005
Nominal applied motor (HP)	1/8	1/4	1/2	1
Reference current (A)	0.8	1.5	3.0	5.0

■ **Braking time (F22)**

F22 specifies the braking period that activates DC braking.

■ **Braking response mode (H95)**

H95 specifies the DC braking response mode.

Data for H95	Characteristics	Note
0	Slow response. Slows the rising edge of the current, thereby preventing reverse rotation at the start of DC braking.	Insufficient braking torque may result at the start of DC braking.
1	Quick response. Quickens the rising edge of the current, thereby accelerating the build-up of the braking torque.	Reverse rotation may result depending on the moment of inertia of the mechanical load and the coupling mechanism.

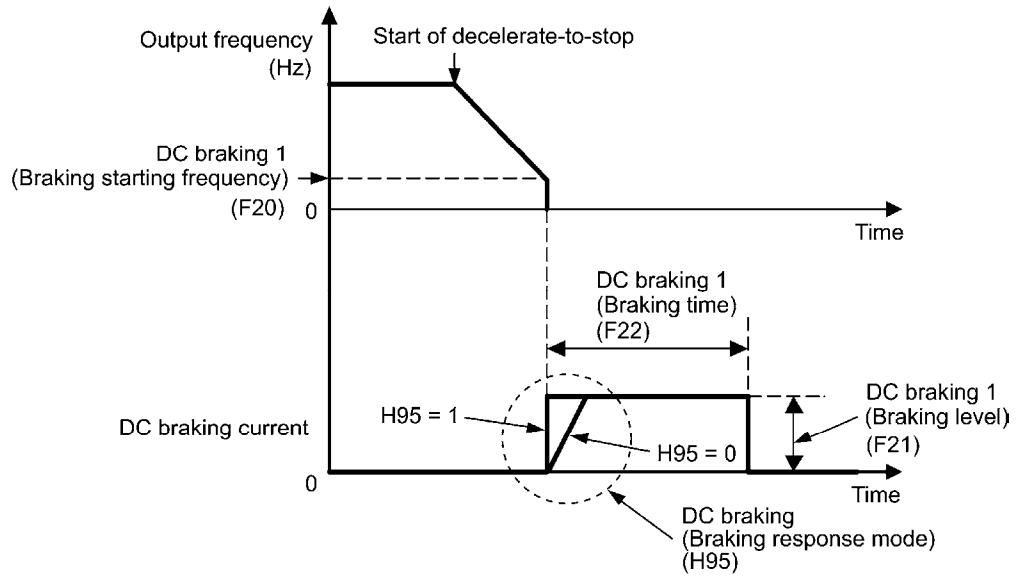

**Tip** It is also possible to use an external digital input signal as an "Enable DC braking" terminal command **DCBRK**.

As long as the **DCBRK** command is ON, the inverter performs DC braking, regardless of the braking time specified by F22.

Turning the **DCBRK** command ON even when the inverter is in a stopped state activates DC braking. This feature allows the motor to be excited before starting, resulting in smoother acceleration (quicker build-up of acceleration torque).

**Note** In general, specify data of function code F20 at a value close to the rated slip frequency of motor. If you set it at an extremely high value, control may become unstable and an overvoltage alarm may result in some cases.

### ⚠ CAUTION

The DC brake function of the inverter does not provide any holding mechanism.

**Injuries could occur.**

<b>F23</b>	<b>Starting Frequency 1</b>	<b>A12 (Starting Frequency 2)</b>
<b>F24</b>	<b>Starting Frequency 1 (Holding time)</b>	
<b>F25</b>	<b>Stop Frequency</b>	<b>F39 (Stop Frequency, Holding time)</b>

At the startup of an inverter, the initial output frequency is equal to the starting frequency 1 specified by F23. The inverter stops its output when the output frequency reaches the stop frequency specified by F25.

Set the starting frequency to a level at which the motor can generate enough torque for startup. Generally, set the motor's rated slip frequency as the starting frequency.

In addition, to compensate for the delay time for the establishment of a magnetic flux in the motor, F24 specifies the holding time for the starting frequency. To stabilize the motor speed at the stop of the motor, F39 specifies the holding time for the stop frequency.

**Note** If the starting frequency is lower than the stop frequency, the inverter will not output any power as long as the reference frequency does not exceed the stop frequency.

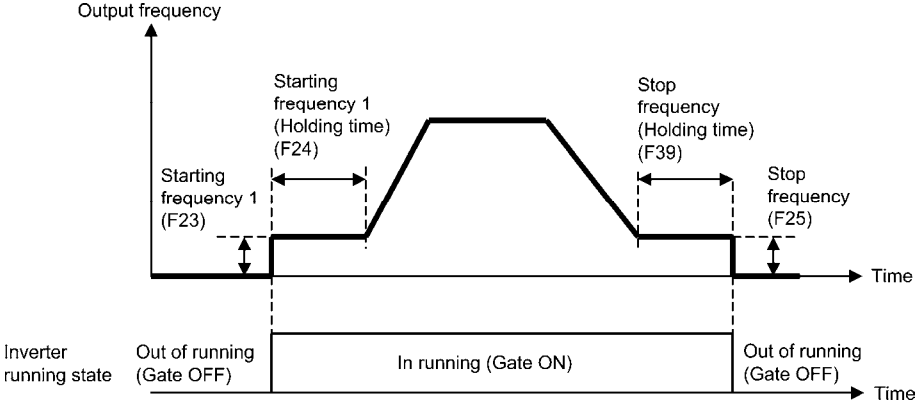

<b>F26</b>	<b>Motor Sound (Carrier frequency)</b>
<b>F27</b>	<b>Motor Sound (Tone)</b>

■ Motor sound (Carrier frequency) (F26)

F26 controls the carrier frequency so as to reduce an audible noise generated by the motor or electromagnetic noise from the inverter itself, and to decrease a leakage current from the main output (secondary) wirings.

Carrier frequency	0.75 to 16 kHz
Motor sound noise emission	High ↔ Low
Motor temperature (due to harmonics components)	High ↔ Low
Ripples in output current waveform	Large ↔ Small
Leakage current	Low ↔ High
Electromagnetic noise emission	Low ↔ High
Inverter loss	Low ↔ High

**Note** Specifying a too low carrier frequency will cause the output current waveform to have a large amount of ripples. As a result, the motor loss increases, causing the motor temperature to rise. Furthermore, the large amount of ripples tends to cause a current limiting alarm. When the carrier frequency is set to 1 kHz or below, therefore, reduce the load so that the inverter output current comes to be 80% or less of the rated current.

When a high carrier frequency is specified, the temperature of the inverter may rise due to an ambient temperature rise or an increase of the load. If it happens, the inverter automatically decreases the carrier frequency to prevent the inverter overload alarm  $\overline{L}L'$ . With consideration for motor noise, the automatic reduction of carrier frequency can be disabled. Refer to the description of H98.

■ Motor sound (Tone) (F27)

F27 changes the motor running sound tone. This setting is effective when the carrier frequency specified by function code F26 is 7 kHz or lower. Changing the tone level may reduce the high and harsh running noise from the motor.

**Note** If the tone level is set too high, the output current may become unstable, or mechanical vibration and noise may increase. Also, this function code may not be very effective for certain types of motor.

<b>F30</b>	<b>Analog Output [FMA] (Voltage adjustment)</b>
<b>F31</b>	<b>Analog Output [FMA] (Function)</b>

These function codes allow terminal [FMA] to output monitored data such as the output frequency and the output current in an analog DC voltage. The magnitude of the output voltage is adjustable.

■ Voltage adjustment (F30)

F30 adjusts the output voltage representing the monitored data selected by F31 within the range of 0 to 300%.

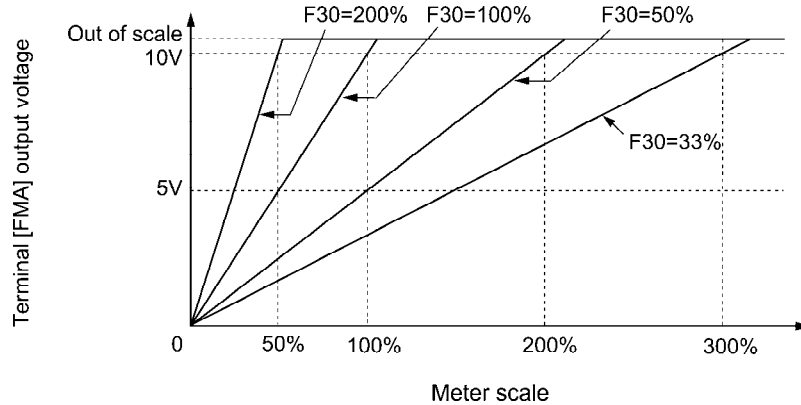

■ Function (F31)

F31 specifies what is output to analog output terminal [FMA].

Data for F31	[FM] output	Function (Monitor the following)	Meter scale (Full scale at 100%)
0	Output frequency (before slip compensation)	Output frequency of the inverter (Equivalent to the motor synchronous speed)	Maximum frequency (F03, A01)
1	Output frequency (after slip compensation)	Output frequency of the inverter	Maximum frequency (F03, A01)
2	Output current	Output current (RMS) of the inverter	Twice the inverter rated current (For the single-phase 100 V class series, see Note on the next page)
3	Output voltage	Output voltage (RMS) of the inverter	250 V for 200 V class series, 500 V for 400 V class series (The setting for the 200 V class series applies also to the single-phase 100 V class series.)
6	Input power	Input power of the inverter	Twice the rated output of the inverter
7	PID feedback amount	Feedback amount under PID control	100% of the feedback amount
9	DC link bus voltage	DC link bus voltage of the inverter	500 V for 200 V class series, 1000 V for 400 V class series (The setting for the 200 V class series applies also to the single-phase 100 V class series.)
14	Calibration	Full scale output of the meter calibration	This always outputs +10 VDC (FMA function).
15	PID command (SV)	Command value under PID control	100% of the PID command value
16	PID output (MV)	Output level of the PID processor under PID control (Frequency command)	Maximum frequency (F03, A01)



In the single-phase 100 V class series, the full-scale value of the output current monitor is twice the reference current. The reference current is given below.

Inverter type: FRN_ _ _ C2S-6U	0001	0002	0003	0005
Nominal applied motor (HP)	1/8	1/4	1/2	1
Reference current (A)	0.8	1.5	3.0	5.0

<b>F37</b>	<b>Load Selection/Auto Torque Boost/Auto Energy Saving Operation 1</b> <b>F09 (Torque Boost 1)</b> <b>A13 (Load Selection/Auto Torque Boost/Auto Energy Saving Operation 2)</b>
------------	---

Refer to the descriptions of function code F09.

<b>F39</b>	<b>Stop Frequency (Holding time)</b>	<b>F25 (Stop Frequency)</b>
------------	--------------------------------------	-----------------------------

Refer to the description of function code F25.

<b>F42</b>	<b>Control Mode Selection 1</b>	<b>A14 (Control Mode Selection 2)</b>
------------	---------------------------------	---------------------------------------

F42 specifies the control mode of the inverter to control a motor.

Data for F42	Control mode
0	V/f control with slip compensation inactive
1	Dynamic torque vector control
2	V/f control with slip compensation active
11	V/f control for PMSM drive

■ V/f control

Under this control, the inverter controls a motor with the voltage and frequency according to the V/f pattern specified by function codes.

■ Slip compensation

Applying any load to an induction motor causes a rotational slip due to the motor characteristics, decreasing the motor rotation. The inverter's slip compensation function first presumes the slip value of the motor based on the motor torque generated and raises the output frequency to compensate for the decrease in motor rotation. This prevents the motor from decreasing the rotation due to the slip.

That is, this function is effective for improving the motor speed control accuracy.

The compensation value is specified by combination of function codes P12 (Rated slip frequency), P09 (Slip compensation gain for driving) and P11 (Slip compensation gain for braking).



### ■ Dynamic torque vector control

To get the maximal torque out of a motor, this control calculates the motor torque matched to the load applied and uses it to optimize the voltage and current vector output.

Selecting this control automatically enables the auto torque boost and slip compensation function and disables auto energy saving operation.

This control is effective for improving the system response to external disturbances and the motor speed control accuracy.

When using the dynamic torque vector control, be sure to match F05 (Rated voltage at base frequency 1) and F06 (Maximum output voltage 1) with the motor rated values. For the 2nd motor, set A03 and A04. When F05 = 0 (Factory default), the inverter runs based on 200 V /400 V.

### ■ V/f control for PMSM drive

Under this control, the inverter drives a permanent magnet synchronous motor (PMSM). Refer to Section 9.3 "Notes in Driving PMSM" for details.

<b>F43</b>	<b>Current Limiter (Mode selection)</b>
<b>F44</b>	<b>Current Limiter (Level)</b>

When the output current of the inverter exceeds the level specified by the current limiter (F44), the inverter automatically manages its output frequency to prevent a stall and limit the output current. (Refer to the description of function code H12.)

The current limiter mode should be selected with F43. If F43 = 1, the current limiter is enabled only during constant speed operation. If F43 = 2, it is enabled during both of acceleration and constant speed operation. Choose F43 = 1 if you need to run the inverter at full capability during acceleration and to limit the output current during constant speed operation.

### ■ Mode selection (F43)

F43 selects the motor running state in which the current limiter becomes activated.

Data for F43	Running states that enable the current limiter		
	During acceleration	During constant speed	During deceleration
0	Disable	Disable	Disable
1	Disable	Enable	Disable
2	Enable	Enable	Disable

### ■ Level (F44)

F44 specifies the operation level at which the output current limiter becomes activated, in ratio to the inverter rating.



- Since the current limit operation with F43 and F44 is performed by software, it may cause a delay in control. If you need a quick response, also enable the instantaneous overcurrent limiting by hardware (H12 = 1).
- If an excessive load is applied when the current limiter operation level is set extremely low, the inverter will rapidly lower its output frequency. This may cause an overvoltage trip or dangerous turnover of the motor rotation due to undershooting.
- For the single-phase 100 V class series, the current limiting level should be calculated based on the reference current as shown below.

Inverter type FRN_ _ _ C2S-6U	0001	0002	0003	0005
Nominal applied motor (HP)	1/8	1/4	1/2	1
Reference current (A)	0.8	1.5	3.0	5.0

<b>F50</b>	<b>Electronic Thermal Overload Protection for Braking Resistor (Discharging capability)</b>
<b>F51</b>	<b>Electronic Thermal Overload Protection for Braking Resistor (Allowable average loss)</b>

A braking resistor can be mounted on inverters of 0.4 kW (1/2 HP) or above.

These function codes specify the electronic thermal overload protection feature for the braking resistor.

Set F50 and F51 data to the discharging capability and allowable average loss, respectively. Those values differ depending on the specifications of the braking resistor, as listed on the following pages.

**Note** Depending on the thermal marginal characteristics of the braking resistor, the electronic thermal overload protection feature may act so that the inverter issues the overheat protection alarm  $\overline{OH}$  even if the actual temperature rise is not large enough. If it happens, review the relationship between the performance index of the braking resistor and settings of related function codes.

The tables below list the discharging capability and allowable average loss of the braking resistor. These values depend upon the inverter and braking resistor models.

#### ■ External Braking Resistors

##### Standard models

The thermal sensor relay mounted on the braking resistor acts as a thermal protector of the motor for overheat, so assign an "Enable external alarm trip" terminal command **THR** to any of digital input terminals [X1] to [X3], [FWD] and [REV] and connect that terminal and its common terminal to braking resistor's terminals 2 and 1.

To protect the motor from overheat without using the thermal sensor relay mounted on the braking resistor, configure the electronic thermal overload protection facility by setting F50 and F51 data to the discharging capability and allowable average loss values listed below, respectively.

Power supply voltage	Inverter type	Braking resistor		Resistance (Ω)	Continuous braking (100% braking torque)		Intermittent braking (Period: 100 s or less)		
		Type	Qty.		Discharging capability (kW <sub>s</sub> )	Braking time (s)	Allowable average loss (kW)	Duty (%ED)	
Three-phase 200 V	FRN0004C2S-2□	DB0.75-2	1	100	9	45	0.044	22	
	FRN0006C2S-2□				17		0.068	18	
	FRN0010C2S-2□	DB2.2-2		40	34	30	0.075	10	
	FRN0012C2S-2□				33		0.077	7	
	FRN0020C2S-2□	DB3.7-2		33	20	37	10	0.093	5
	FRN0025C2S-2□	DB5.5-2		20		55		0.138	
	FRN0033C2S-2□	DB7.5-2		15	37	0.188			
	FRN0047C2S-2□	DB11-2		10	55	0.275			
FRN0060C2S-2□	DB15-2	8.6	75	0.375					
Three-phase 400 V	FRN0002C2■-4□	DB0.75-4	1	200	9	45	0.044	22	
	FRN0004C2■-4□				17		0.068	18	
	FRN0005C2■-4□	DB2.2-4		160	34	30	0.075	10	
	FRN0007C2■-4□				33		0.077	7	
	FRN0011C2■-4□	DB3.7-4		130	20	37	10	0.093	5
	FRN0013C2■-4□	DB5.5-4		80		55		0.138	
	FRN0018C2■-4□	DB7.5-4		60	38	0.188			
	FRN0024C2■-4□	DB11-4		40	55	0.275			
FRN0030C2■-4□	DB15-4	34.4	75	0.375					

Power supply voltage	Inverter type	Braking resistor		Resistance (Ω)	Continuous braking (100% braking torque)		Intermittent braking (Period: 100 s or less)	
		Type	Qty.		Discharging capability (kW)	Braking time (s)	Allowable average loss (kW)	Duty (%ED)
Single-phase 200 V	FRN0004C2■-7□	DB0.75-2	1	100	9	45	0.044	22
	FRN0006C2■-7□				17		0.068	18
	FRN0010C2■-7□	DB2.2-2		40	34	30	0.075	10
	FRN0012C2■-7□			33	30	0.077	7	
Single-phase 100 V	FRN0003C2S-6U	DB0.75-2	1	100	9	45	0.044	22
	FRN0005C2S-6U				17		45	0.068

Notes: A box (□) in the above table replaces A, C, E, or U depending on the shipping destination. For three-phase 200 V class series of inverters, it replaces A or U.

A box (■) in the above tables replaces S (Basic type) or E (EMC filter built-in type) depending on the enclosure.

**Compact models**

When using the compact models of braking resistor TK80W120Ω or TK80W100Ω, set F50 to "7" and F51 to "0.033."

**10% ED models**

Power supply voltage	Inverter type	Braking resistor		Resistance (Ω)	Continuous braking (100% braking torque)		Intermittent braking (Period: 100 s or less)		
		Type	Qty.		Discharging capacity (kW)	Braking time (s)	Allowable average loss (kW)	Duty (%ED)	
Three-phase 200 V	FRN0004C2S-2□	DB0.75-2C	1	100	50	250	0.075	37	
	FRN0006C2S-2□					133		20	
	FRN0010C2S-2□	DB2.2-2C		40	55	73	0.110	10	
	FRN0012C2S-2□			50	50				
	FRN0020C2S-2□	DB3.7-2C		33	140	75	0.185		
	FRN0025C2S-2□	DB5.5-2C		20	55	20	0.275		
	FRN0033C2S-2□	DB7.5-2C		15	37	10	0.375		
	FRN0047C2S-2□	DB11-2C		10	55		0.55		
FRN0060C2S-2□	DB15-2C	8.6	75	75	0.75				
Three-phase 400 V	FRN0002C2■-4□	DB0.75-4C	1	200	50	250	0.075		37
	FRN0004C2■-4□					133		20	
	FRN0005C2■-4□	DB2.2-4C		160	55	73	0.110	10	
	FRN0007C2■-4□			50	50				
	FRN0011C2■-4□	DB3.7-4C		130	140	75	0.185		
	FRN0013C2■-4□	DB5.5-4C		80	55	20	0.275		
	FRN0018C2■-4□	DB7.5-4C		60	38	10	0.375		
	FRN0024C2■-4□	DB11-4C		40	55		0.55		
FRN0030C2■-4□	DB15-4C	34.4	75	75	0.75				
Single-phase 200 V	FRN0004C2■-7□	DB0.75-2C	1	100	50	250	0.075		37
	FRN0006C2■-7□					133		20	
	FRN0010C2■-7□	DB2.2-2C		40	55	73	0.110	14	
	FRN0012C2■-7□			50	50	10			
Single-phase 100 V	FRN0003C2S-6U	DB0.75-2C		1	100	50	250	0.075	37
	FRN0005C2S-6U						133		20

Notes: A box (□) in the above table replaces A, C, E, or U depending on the shipping destination. For three-phase 200 V class series of inverters, it replaces A or U.

A box (■) in the above tables replaces S (Basic type) or E (EMC filter built-in type) depending on the enclosure.

**Calculating the discharging capability and allowable average loss of the braking resistor and configuring the function code data**

When using a braking resistor other than the ones listed in the above table, calculate data to be set to function codes according to the tables and expressions.

■ Discharging capability (F50)

The discharging capability refers to kW's allowable for a single braking cycle, which is obtained by the following expressions "(1) Regeneration power during deceleration" and "(2) Regeneration power at a constant speed," based on the braking time and motor rating.

Data for F50	Function
OFF	Disable the electronic thermal overload protection. (This setting is equivalent to "999" in the FRN□□□C1■-□□.)
1 to 900	1 to 900 (kW's)

During deceleration:

$$\text{Discharging capacity (kW's)} = \frac{\text{Braking time (s)} \times \text{Motor rating (kW)}}{2} \quad (1)$$

At a constant speed:

$$\text{Discharging capacity (kW's)} = \text{Braking time (s)} \times \text{Motor rating (kW)} \quad (2)$$

■ Allowable average loss (F51)

The allowable average loss refers to a tolerance for motor continuous operation, which is obtained by the following expressions "(3) Regeneration power during deceleration" and "(4) Regeneration power at a constant speed," based on the %ED (%) and motor rating (kW).

Data for F51	Function
0.001 to 50.000	0.001 to 50.000 (kW)

During deceleration:

$$\text{Allowable average loss (kW)} = \frac{\frac{\%ED (\%)}{100} \times \text{Motor rating (kW)}}{2} \quad (3)$$

At a constant speed:

$$\text{Allowable average loss (kW)} = \frac{\%ED (\%)}{100} \times \text{Motor rating (kW)} \quad (4)$$

When the motor decelerates, apply expressions (1) and (3), and when it runs at a constant speed, expressions (2) and (4). The obtained data differs depending upon the motor's running state.

### 9.2.2 E codes (Extension terminal functions)

E01	Terminal [X1] Function	E98 (Terminal [FWD] Function)
E02	Terminal [X2] Function	E99 (Terminal [REV] Function)
E03	Terminal [X3] Function	

Function codes E01 to E03, E98 and E99 assign commands (listed on the next page) to general-purpose, programmable, digital input terminals [X1] to [X3], [FWD], and [REV].

These function codes can also switch the logic system between normal and negative to define how the inverter logic interprets the ON or OFF state of each terminal. The default setting is normal logic system "Active ON." So, explanations that follow are given in normal logic system.

#### ⚠ CAUTION

- Ensure safety before modifying the function code settings.  
Run commands (e.g., "Run forward" *FWD*), stop commands (e.g., "Coast to a stop" *BX*), and frequency change commands can be assigned to digital input terminals. Depending upon the assignment states of those terminals, modifying the function code setting may cause a sudden motor start or an abrupt change in speed.
- When the inverter is controlled with the digital input signals, switching run or frequency command sources with the related terminal commands (e.g., *SS1*, *SS2*, *SS4*, *SS8*, *Hz2/Hz1*, *Hz/PID*, *IVS*, and *LE*) may cause a sudden motor start or an abrupt change in speed.

**An accident or physical injury may result.**

Function code data		Terminal commands assigned	Symbol
Active ON	Active OFF		
0	1000	Select multistep frequency (0 to 15 steps)	<i>SS1</i>
1	1001		<i>SS2</i>
2	1002		<i>SS4</i>
3	1003		<i>SS8</i>
4	1004	Select ACC/DEC time	<i>RT1</i>
6	1006	Enable 3-wire operation	<i>HLD</i>
7	1007	Coast to a stop	<i>BX</i>
8	1008	Reset alarm	<i>RST</i>
1009	9	Enable external alarm trip	<i>THR</i>
10	1010	Ready for jogging	<i>JOG</i>
11	1011	Select frequency command 2/1	<i>Hz2/Hz1</i>
12	1012	Select motor 2 / motor 1	<i>M2/M1</i>
13	–	Enable DC braking	<i>DCBRK</i>
17	1017	UP (Increase output frequency)	<i>UP</i>
18	1018	DOWN (Decrease output frequency)	<i>DOWN</i>
19	1019	Enable data change with keypad	<i>WE-KP</i>
20	1020	Cancel PID control	<i>Hz/PID</i>
21	1021	Switch normal/inverse operation	<i>IVS</i>
24	1024	Enable communications link via RS-485	<i>LE</i>
33	1033	Reset PID integral and differential components	<i>PID-RST</i>
34	1034	Hold PID integral component	<i>PID-HLD</i>
98	–	Run forward (Exclusively assigned to [FWD] and [REV] terminals by E98 and E99)	<i>FWD</i>
99	–	Run reverse (Exclusively assigned to [FWD] and [REV] terminals by E98 and E99)	<i>REV</i>

**Note** Any negative logic (Active OFF) command cannot be assigned to the functions marked with "–" in the "Active OFF" column.

The "Enable external alarm trip" and "Force to stop" are fail-safe terminal commands. For example, when data = 9 in "Enable external alarm trip," "Active OFF" (alarm is triggered when OFF); when data = 1009, "Active ON" (alarm is triggered when ON).

Terminal function assignment and data setting

- Select multistep frequency (0 to 15 steps) -- **SS1, SS2, SS4, and SS8**  
(Function code data = 0, 1, 2, and 3)

The combination of the ON/OFF states of digital input signals **SS1, SS2, SS4** and **SS8** selects one of 16 different frequency commands defined beforehand by 15 function codes C05 to C19 (Multistep frequency 0 to 15). With this, the inverter can drive the motor at 16 different preset frequencies.

The table below lists the frequencies that can be obtained by the combination of switching **SS1, SS2, SS4** and **SS8**. In the "Selected frequency" column, "Other than multistep frequency" represents the reference frequency sourced by frequency command 1 (F01), frequency command 2 (C30), or others. For details, refer to the block diagram in Section 4.2 "Drive Frequency Command Block."

<b>SS8</b>	<b>SS4</b>	<b>SS2</b>	<b>SS1</b>	Selected frequency
OFF	OFF	OFF	OFF	Other than multistep frequency
OFF	OFF	OFF	ON	C05 (Multistep frequency 1)
OFF	OFF	ON	OFF	C06 (Multistep frequency 2)
OFF	OFF	ON	ON	C07 (Multistep frequency 3)
OFF	ON	OFF	OFF	C08 (Multistep frequency 4)
OFF	ON	OFF	ON	C09 (Multistep frequency 5)
OFF	ON	ON	OFF	C10 (Multistep frequency 6)
OFF	ON	ON	ON	C11 (Multistep frequency 7)
ON	OFF	OFF	OFF	C12 (Multistep frequency 8)
ON	OFF	OFF	ON	C13 (Multistep frequency 9)
ON	OFF	ON	OFF	C14 (Multistep frequency 10)
ON	OFF	ON	ON	C15 (Multistep frequency 11)
ON	ON	OFF	OFF	C16 (Multistep frequency 12)
ON	ON	OFF	ON	C17 (Multistep frequency 13)
ON	ON	ON	OFF	C18 (Multistep frequency 14)
ON	ON	ON	ON	C19 (Multistep frequency 15)

- Select ACC/DEC time -- **RT1**  
(Function code data = 4)

This terminal command switches between ACC/DEC time 1 (F07, F08) and ACC/DEC time 2 (E10, E11).

If no **RT1** command is assigned, ACC/DEC time 1 (F07, F08) takes effect by default.

Input terminal command <b>RT1</b>	Acceleration/deceleration time
OFF	Acceleration/deceleration time 1 (F07, F08)
ON	Acceleration/deceleration time 2 (E10, E11)

- Enable 3-wire operation -- **HLD**  
(Function code data = 6)

Turning this terminal command ON self-holds the forward **FWD** or reverse **REV** run command issued with it, to enable 3-wire inverter operation.

Turning **HLD** ON self-holds the first **FWD** or **REV** command at its leading edge. Turning **HLD** OFF releases the self-holding.

When **HLD** is not assigned, 2-wire operation involving only **FWD** and **REV** takes effect.

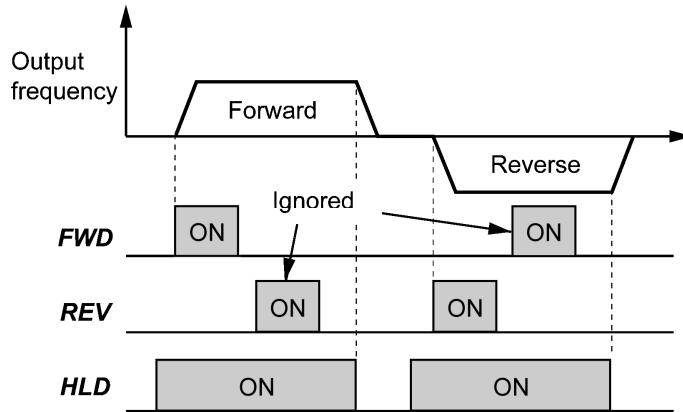

- Coast to a stop -- **BX**  
(Function code data = 7)

Turning this terminal command ON immediately shuts down the inverter output so that the motor coasts to a stop without issuing any alarms.

- Reset alarm -- **RST**  
(Function code data = 8)

Turning this terminal command ON clears the **ALM** state--alarm output (for any fault). Turning it OFF erases the alarm display and clears the alarm hold state.

When you turn the **RST** command ON, keep it ON for 10 ms or more. This command should be kept OFF for the normal inverter operation.

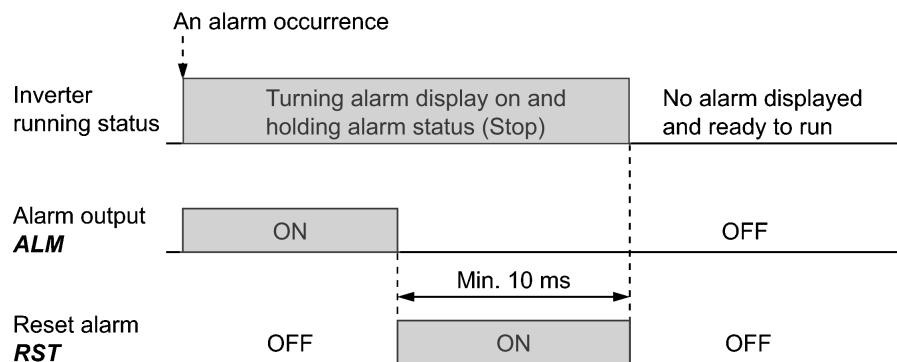

- Enable external alarm trip -- **THR**  
(Function code data = 9)

Turning this terminal command OFF immediately shuts down the inverter output (so that the motor coasts to a stop), displays the alarm  $\overline{H-L}$ , and outputs the alarm relay (for any fault) **ALM**. The **THR** command is self-held, and is reset when an alarm reset takes place.

 **Tip** Use this alarm trip command from external equipment when you have to immediately shut down the inverter output in the event of an abnormal situation in a peripheral equipment.



■ Ready for jogging -- **JOG**  
(Function code data = 10)

This terminal command is used to jog or inch the motor for positioning a workpiece.

Turning this command ON makes the inverter ready for jogging.

Simultaneous keying  $\text{STOP} + \text{JOG}$  keys on the keypad is functionally equivalent to this command; however, it is restricted by the run command source as listed below.

When the run command source is the keypad (F02 = 0, 2 or 3):

Input terminal command <b>JOG</b>	$\text{STOP} + \text{JOG}$ keys on the keypad	Inverter running state
ON	—	Ready for jogging
OFF	Pressing these keys toggles between the "normal operation" and "ready for jogging."	Normal operation
		Ready for jogging

When the run command source is digital input (F02 = 1):

Input terminal command <b>JOG</b>	$\text{STOP} + \text{JOG}$ keys on the keypad	Inverter running state
ON	Disable	Ready for jogging
OFF		Normal operation

#### Jogging operation

Pressing the  $\text{RUN}$  key or turning the **FWD** or **REV** terminal command ON starts jogging.

For the jogging by the keypad, the inverter jogs only when the  $\text{RUN}$  key is held down. Releasing the  $\text{RUN}$  key decelerates to stop.

During jogging, the frequency specified by C20 (Jogging frequency) and the acceleration/deceleration time specified by H54 (ACC/DEC time) applies.

- Note**
- The inverter's status transition between "ready for jogging" and "normal operation" is possible only when the inverter is stopped.
  - To start jogging operation by simultaneously entering the **JOG** terminal command and a run command (e.g., **FWD**), the input delay time between the two commands should be within 100 ms. If a run command **FWD** is entered first, the inverter does not jog the motor but runs it ordinarily until the next input of the **JOG**.

■ Select frequency command 2/1 -- **Hz2/Hz1**  
(Function code data = 11)

Turning this terminal command ON and OFF switches the frequency command source between frequency command 1 (F01) and frequency command 2 (C30).

If no **Hz2/Hz1** terminal command is assigned, the frequency sourced by F01 takes effect by default.

Input terminal command <b>Hz2/Hz1</b>	Frequency command source
OFF	Follow F01 (Frequency command 1)
ON	Follow C30 (Frequency command 2)

- Select motor 2 / motor 1 -- **M2/M1**  
(Function code data = 12)

Turning this terminal command ON switches from the 1st motor to the 2nd one. Switching is possible only when the inverter is stopped. Upon completion of switching, the digital terminal output "Switched to motor 2" **SWM2** (assigned to any of terminals [Y1] and [30A/B/C]) turns ON.

If no **M2/M1** terminal command is assigned, the 1st motor is selected by default.

Input terminal command <b>M2/M1</b>	Selected motor	<b>SWM2</b> status after completion of switching
OFF	1st motor	OFF
ON	2nd motor	ON

Switching between the 1st and 2nd motors automatically switches applicable function codes as listed below. The inverter runs the motor with those codes that should be properly configured.

Function code name		For 1st motor	For 2nd motor
Maximum Frequency		F03	A01
Base Frequency		F04	A02
Rated voltage at Base Frequency		F05	A03
Maximum Output Voltage		F06	A04
Torque Boost		F09	A05
Electronic Thermal Overload Protection for Motor (Select motor characteristics) (Overload detection level) (Thermal time constant)		F10	A06
		F11	A07
		F12	A08
DC Braking (Braking starting frequency) (Braking level) (Braking time)		F20	A09
		F21	A10
		F22	A11
Starting Frequency		F23	A12
Load Selection/Auto Torque Boost/Auto Energy Saving Operation		F37	A13
Control Mode Selection		F42	A14
Motor Parameters (Rated capacity)		P02	A16
(Rated current)		P03	A17
(Auto-tuning)		P04	A18
(No-load current)		P06	A20
(%R1)		P07	A21
(%X)		P08	A22
(Slip compensation gain for driving)		P09	A23
(Slip compensation response time)		P10	A24
(Slip compensation gain for braking)		P11	A25
(Rated slip frequency)		P12	A26
Motor Selection		P99	A39
Output Current Fluctuation Damping Gain for Motor		H80	A41
Cumulative Motor Run Time		H94	A51
Startup Counter of Motor		H44	A52

The 2nd motor imposes functional restrictions on the following function codes. Confirm the settings of those function codes before use.

Functions	Restrictions	Related function codes
Non-linear V/f pattern	Disabled. Linear V/f pattern only	H50 to H53
Starting frequency	Starting frequency holding time not supported.	F24
Stop frequency	Stop frequency holding time not supported.	F39
Overload early warning	Disabled.	E34 and E35
<b>UP/DOWN</b> control	Disabled. Fixed at default setting 0.	H61
PID control	Disabled.	J01
Braking signal	Disabled.	J68 to J72
Software current limiter	Disabled.	F43 and F44
Rotation direction limitation	Disabled.	H08

**Note** To run the 2nd motor with the **M2/MI** terminal command and a run command (e.g., **FWD**), the input of the **M2/MI** should not be delayed 10 ms or more from that of the run command. If the delay exceeds 10 ms, the 1st motor will be driven by default.

- Enable DC braking -- **DCBRK**  
(Function code data = 13)

This terminal command gives the inverter a DC braking command through the inverter's digital input.

(Refer to the descriptions of F20 to F22.)

- UP (Increase output frequency) and DOWN (Decrease output frequency) commands -- **UP** and **DOWN**  
(Function code data = 17, 18)

• **Frequency setting**

When the **UP/DOWN** control is selected for frequency setting with a run command ON, turning the **UP** or **DOWN** terminal command ON causes the output frequency to increase or decrease, respectively, within the range from 0 Hz to the maximum frequency as listed below.

<b>UP</b>	<b>DOWN</b>	Function
Data = 17	Data = 18	
OFF	OFF	Keep the current output frequency.
ON	OFF	Increase the output frequency with the acceleration time currently specified.
OFF	ON	Decrease the output frequency with the deceleration time currently specified.
ON	ON	Keep the current output frequency.

The **UP/DOWN** control is available in two modes--one mode ( $H61 = 0$ ) in which the initial value of the reference frequency is fixed to "0.00" at the start of the **UP/DOWN** control and the other mode ( $H61 = 1$ ) in which the reference frequency applied in the previous **UP/DOWN** control applies as the initial value.

When  $H61 = 0$ , the reference frequency applied by the previous **UP/DOWN** control has been cleared to "0," so at the next restart (including powering on), use the **UP** terminal command to accelerate the speed as needed.

When  $H61 = 1$ , the inverter internally holds the current output frequency set by the **UP/DOWN** control and applies the held frequency at the next restart (including powering on).

**Note** At the time of restart, if an **UP** or **DOWN** terminal command is entered before the internal frequency reaches the output frequency saved in the memory, the inverter saves the current output frequency into the memory and starts the **UP/DOWN** control with the new frequency. The previous frequency held will be overwritten by the current one.

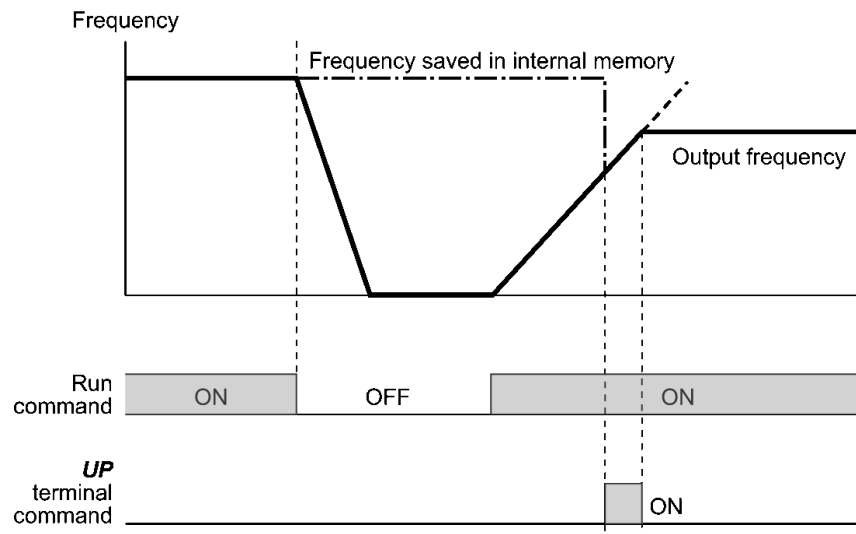

Initial frequency for **UP/DOWN** control when the frequency command source is switched

When the frequency command source is switched to **UP/DOWN** control from other sources, the initial frequency for **UP/DOWN** control is as listed below:

Frequency command source	Switching command	Initial frequency for <b>UP/DOWN</b> control	
		H61 = 0	H61 = 1
Other than <b>UP/DOWN</b> (F01, C30)	Select frequency command 2/1 ( <b>Hz2/Hz1</b> )	Reference frequency given by the frequency command source used just before switching	
PID control	Cancel PID control ( <b>Hz/PID</b> )	Reference frequency given by PID control (PID processor output)	
Multistep frequency	Select multistep frequency ( <b>SS1, SS2, SS4 and SS8</b> )	Reference frequency given by the frequency command source used just before switching	Reference frequency at the time of previous <b>UP/DOWN</b> control
Communications link	Enable communications link via RS-485 ( <b>LE</b> )	Reference frequency given by the frequency command source used just before switching	Reference frequency at the time of previous <b>UP/DOWN</b> control

**Note** To enable the **UP** and **DOWN** terminal commands, you need to set frequency command 1 (F01) or frequency command 2 (C30) to "7" beforehand.

### • Changing the PID command

When **UP/DOWN** control is selected as a PID command, turning the terminal command **UP** or **DOWN** ON with a run command being ON causes the PID command to change within the range from 0 to 100%.

The PID command can be specified in mnemonic physical quantities (such as temperature or pressure) with the PID display coefficients (E40, E41).

<b>UP</b>	<b>DOWN</b>	Function
Data = 17	Data = 18	
OFF	OFF	Retain PID command value.
ON	OFF	Increase PID command value at a rate between 0.1%/0.1 s and 1%/0.1 s.
OFF	ON	Decrease PID command value at a rate between 0.1%/0.1 s and 1%/0.1 s.
ON	ON	Retain PID command value.

Selecting the PID control for process control (J01 = 1 or 2) validates the H61 data as well as frequency commands.

**Note** To validate **UP** and **DOWN** terminal commands, it is necessary to select the PID control (Remote command **SV**) (J02 = 3).

### ■ Enable data change with keypad -- **WE-KP** (Function code data = 19)

Turning this terminal command OFF protects function code data from accidentally getting changed with the keypad.

Only when the **WE-KP** is ON, you can change function code data with the keypad according to the setting of function code F00 as listed below.

<b>WE-KP</b>	F00	Function
OFF	--	Disable changing of all function code data
ON	0 or 2	Enable changing of all function code data
	1 or 3	Disable changing of all function code data except F00 data

If no **WE-KP** terminal command is assigned, the inverter interprets **WE-KP** as being ON by default.

- Note**
- If you mistakenly assign a **WE-KP** to any digital input terminal, you can no longer edit or modify function code data. In such a case, temporarily turn this **WE-KP**-assigned terminal ON and reassign the **WE-KP** terminal command to a correct command.
  - **WE-KP** is only a signal that allows you to change function code data, so it does not protect the frequency settings or PID command specified by the  $\wedge$  and  $\vee$  keys.

- Cancel PID control -- **Hz/PID**  
(Function code data = 20)

Turning this terminal command ON disables PID control.

If the PID control is disabled with this command, the inverter runs the motor with the reference frequency manually set by any of the multistep frequency, keypad, analog input, etc.

<i>Hz/PID</i>	Function
OFF	Enable PID control
ON	Disable PID control/Enable manual settings

- Switch normal/inverse operation -- **IVS**  
(Function code data = 21)

This terminal command switches the output frequency control between normal (proportional to the input value) and inverse and in manual frequency setting or under PID process control. To select the inverse operation, turn the **IVS** ON.

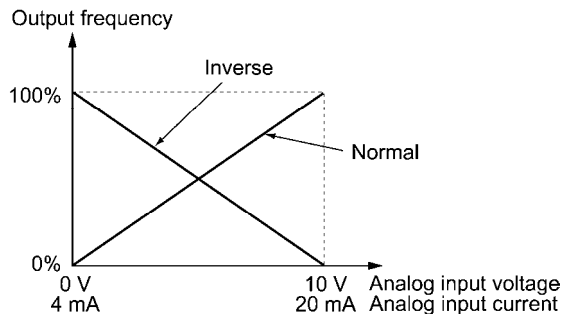

**Tip** The normal/inverse switching operation is useful for air-conditioners that require switching between cooling and heating. In cooling, the speed of the fan motor (output frequency of the inverter) is increased to lower the temperature. In heating, it is reduced to lower the temperature. This switching is realized by the **IVS**.

- **When the inverter is driven by an external analog frequency command sources (terminals [12] and [C1]):**

Switching normal/inverse operation can apply only to the analog frequency command sources (terminals [12] and [C1]) in frequency command 1 (F01) and does not affect frequency command 2 (C30) or UP/DOWN control.

- **When process control is performed by the PID processor integrated in the inverter:**

The **Hz/PID** terminal command ("Cancel PID control") can switch PID control between enabled (process is to be controlled by the PID processor) and disabled (process is to be controlled by the manual frequency setting). In either case, the combination of the "PID control" (J01) and the **IVS** terminal command determines the final operation as listed below.

When PID control is enabled:

The normal/inverse operation selection for the PID processor output (reference frequency) is as follows.

PID control (Mode selection) (J01)	<i>IVS</i>	Final operation
1: Enable (normal operation)	OFF	Normal
	ON	Inverse
2: Enable (inverse operation)	OFF	Inverse
	ON	Normal

**Note** When the process control is performed by the PID processor integrated in the inverter, the *IVS* terminal command is used to switch the PID processor output (reference frequency) between normal and inverse, and has no effect on any normal/inverse operation selection of the manual frequency setting.

- Enable communications link via RS-485 -- **LE**  
(Function code data = 24)

Turning this terminal command ON gives priorities to frequency commands or run commands received via the RS-485 communications link (H30).

No **LE** assignment is functionally equivalent to the **LE** being ON. (Refer to the description of H30.)

- Reset PID integral and differential components -- **PID-RST**  
(Function code data = 33)

Turning this terminal command ON resets the integral and differential components of the PID processor.

- Hold PID integral component -- **PID-HLD**  
(Function code data = 34)

Turning this terminal command ON holds the integral components of the PID processor.

- Run forward -- **FWD**  
(Function code data = 98)

Turning this terminal command ON runs the motor in the forward direction; turning it OFF decelerates it to stop.

**Tip** This terminal command can be assigned only by E98 or E99.

- Run reverse -- **REV**  
(Function code data = 99)

Turning this terminal command ON runs the motor in the reverse direction; turning it OFF decelerates it to stop.

**Tip** This terminal command can be assigned only by E98 or E99.

<b>E10</b>	<b>Acceleration Time 2</b>	<b>F07 (Acceleration Time 1)</b>
<b>E11</b>	<b>Deceleration Time 2</b>	<b>F08 (Deceleration Time 1)</b>

Refer to the descriptions of function codes F07 and F08.

<b>E20</b>	<b>Terminal [Y1] Function</b>
<b>E27</b>	<b>Terminal [30A/B/C] Function (Relay output)</b>

E20 and E27 assign output signals (listed on the next page) to general-purpose, programmable output terminals [Y1] and [30A/B/C]. These function codes can also switch the logic system between normal and negative to define the property of those output terminals so that the inverter logic can interpret either the ON or OFF status of each terminal as active. The factory default settings are "Active ON."

Terminal [Y1] is a transistor output and terminals [30A/B/C] are relay contact outputs. In normal logic, if an alarm occurs, the relay will be energized so that [30A] and [30C] will be closed, and [30B] and [30C] opened. In negative logic, the relay will be deenergized so that [30A] and [30C] will be opened, and [30B] and [30C] closed. This may be useful for the implementation of failsafe power systems.

- Note**
- When a negative logic is employed, all output signals are active (e.g. an alarm would be recognized) while the inverter is powered OFF. To avoid causing system malfunctions by this, interlock these signals to keep them ON using an external power supply. Furthermore, the validity of these output signals is not guaranteed for approximately 1.5 seconds after power-on, so introduce such a mechanism that masks them during the transient period.
  - Terminals [30A/B/C] use mechanical contacts that cannot stand frequent ON/OFF switching. Where frequent ON/OFF switching is anticipated (for example, limiting a current by using signals subjected to inverter output limit control such as switching to commercial power line), use transistor output [Y1] instead. The service life of a relay is approximately 200,000 times if it is switched on and off at one-second intervals.



The table below lists functions that can be assigned to terminals [Y1] and [30A/B/C].

To make the explanations simpler, the examples shown below are all written for the normal logic (Active ON.)

Function code data		Functions assigned	Symbol
Active ON	Active OFF		
0	1000	Inverter running	<b><i>RUN</i></b>
1	1001	Frequency arrival signal	<b><i>FAR</i></b>
2	1002	Frequency detected	<b><i>FDT</i></b>
3	1003	Undervoltage detected (Inverter stopped)	<b><i>LU</i></b>
5	1005	Inverter output limiting	<b><i>IOL</i></b>
6	1006	Auto-restarting after momentary power failure	<b><i>IPF</i></b>
7	1007	Motor overload early warning	<b><i>OL</i></b>
26	1026	Auto-resetting	<b><i>TRY</i></b>
30	1030	Service lifetime alarm	<b><i>LIFE</i></b>
35	1035	Inverter running 2	<b><i>RUN2</i></b>
36	1036	Overload prevention control	<b><i>OLP</i></b>
37	1037	Current detected	<b><i>ID</i></b>
38	1038	Current detected 2	<b><i>ID2</i></b>
41	1041	Low current detected	<b><i>IDL</i></b>
43	1043	Under PID control	<b><i>PID-CTL</i></b>
44	1044	Motor stopped due to slow flowrate under PID control	<b><i>PID-STP</i></b>
49	1049	Switched to motor 2	<b><i>SWM2</i></b>
56	1056	Motor overheat detected by thermistor (PTC)	<b><i>THM</i></b>
57	1057	Brake signal	<b><i>BRKS</i></b>
59	1059	Terminal [C1] wire break	<b><i>C1OFF</i></b>
84	1084	Maintenance timer	<b><i>MNT</i></b>
87	1087	Frequency arrival detected	<b><i>FARFDT</i></b>
99	1099	Alarm output (for any alarm)	<b><i>ALM</i></b>

■ Inverter running -- ***RUN***  
(Function code data = 0)

This output signal tells the external equipment that the inverter is running at a starting frequency or higher. It comes ON when the output frequency exceeds the starting frequency, and it goes OFF when it is less than the stop frequency. It is also OFF when the DC braking is in operation.

If this signal is assigned in negative logic (Active OFF), it can be used as a signal indicating "Inverter being stopped."

■ Frequency arrival signal -- ***FAR***  
(Function code data = 1)

This output signal comes ON when the difference between the output frequency and reference frequency comes within the frequency arrival hysteresis width specified by E30. (Refer to the description of E30.)

---

■ Frequency detected -- **FDT**  
(Function code data = 2)

This output signal comes ON when the output frequency exceeds the frequency detection level specified by E31, and it goes OFF when the output frequency drops below the "Frequency detection level (E31) - Hysteresis width (E32)."

■ Undervoltage detected -- **LU**  
(Function code data = 3)

This output signal comes ON when the DC link bus voltage of the inverter drops below the specified undervoltage level, and it goes OFF when the voltage exceeds the level.

When this signal is ON, the inverter cannot run even if a run command is given.

This signal is ON also when the undervoltage protective function is activated so that the motor is in an abnormal stop state (e.g., tripped).

■ Inverter output limiting -- **IOL**  
(Function code data = 5)

This output signal comes ON when the inverter is limiting the output frequency by activating any of the following actions (minimum width of the output signal: 100 ms).

- Current limiting by software (F43 and F44)
- Instantaneous overcurrent limiting by hardware (H12 = 1)
- Automatic deceleration (Anti-regenerative control) (H69 = 2 or 4)

 **Note** When the **IOL** is ON, the output frequency may have deviated from the specified reference frequency because of the limiting function above.

■ Auto-restarting after momentary power failure -- **IPF**  
(Function code data = 6)

This output signal is ON either during continuous running after a momentary power failure or during the period from when the inverter detects an undervoltage condition and shuts down the output until completion of a restart sequence (the output reaches the reference frequency).

To enable the **IPF**, set F14 (Restart mode after momentary power failure) to "4" (Enable restart (Restart at the frequency at which the power failure occurred)) or "5" (Enable restart (Restart at the starting frequency)) beforehand.

■ Motor overload early warning -- **OL**  
(Function code data = 7)

This output signal is used to issue a motor overload early warning that enables you to take a corrective action before the inverter detects a motor overload alarm  and shuts down its output. (Refer to the description of E34.)

■ Auto-resetting -- **TRY**  
(Function code data = 26)

This output signal comes ON when auto-resetting is in progress. The auto-resetting is specified by H04 and H05 (Auto-reset). Refer to the descriptions of H04 and H05 for details about the number of resetting times and reset interval.

 Refer to the description of function codes H04 and H05 for details of the signal output timing and the number of retries.

■ Service life alarm -- **LIFE**  
(Function code data = 30)

This output signal comes ON when it is judged that the service life of any one of capacitors (DC link bus capacitors and electrolytic capacitors on the printed circuit boards) and cooling fan has expired.

This signal should be used as a guide for replacement of the capacitors and cooling fan. If this signal comes ON, use the specified maintenance procedure to check the service life of these parts and determine whether the parts should be replaced or not.

For detail, refer to the FRENIC-Mini Instruction Manual (INR-SI47-1729-E), Chapter 7 "MAINTENANCE AND INSPECTION."

Consumable part	Judgment criteria of life forecasting
DC link bus capacitor	85.0% or below of the initial capacitance at shipment
Electrolytic capacitors on printed circuit boards	Exceeding 87,000 hours of cumulative run time (Estimated at an inverter ambient temperature of 40°C and load factor of 80%)
Cooling fan	Exceeding 87,000 hours of cumulative run time (Estimated at an inverter ambient temperature of 40°C and load factor of 80%)

■ Inverter running 2 -- **RUN2**  
(Function code data = 35)

This signal acts in the same way as **RUN** (Function code data = 0) except that **RUN2** is ON even when the DC braking is in operation.

■ Overload prevention control -- **OLP**  
(Function code data = 36)

This output signal comes ON when overload prevention control is activated. The minimum ON-duration is 100 ms. (Refer to the description of H70.)

■ Current detected and Current detected 2 -- **ID** and **ID2**  
(Function code data = 37, 38)

The **ID** or **ID2** output signal comes ON when the output current of the inverter exceeds the level specified by E34 (Current detection (Level)) or E37 (Current detection 2 (Level)) and stays above that level for the period longer than the one specified by E35 (Current detection (Timer)) or E38 (Current detection 2 (Timer)), respectively. The minimum ON-duration is 100 ms.

The **ID** or **ID2** goes OFF when the output current drops below 90% of the rated operation level.

These two output signals can be assigned to two different digital output terminals independently if necessary.

 **Note** Function code E34 is effective for not only the operation level of the current detection **ID** but also the motor overload early warning **OL**. (Refer to the description of E34.)

■ Low current detected -- **IDL**  
(Function code data = 41)

This output signal comes ON when the inverter output current drops below the low current detection level (E34) and it remains at the low level for the timer period (E35). When the output current exceeds the current detection level (E37) by 5% or more of the inverter rated current, this signal goes OFF. The minimum ON-duration is 100 ms. (Refer to the description of E34.)

- Under PID control -- **PID-CTL**  
(Function code data = 43)

This output signal comes ON when PID control is enabled ("Cancel PID control" (**Hz/PID**) = OFF) and a run command is ON. (Refer to the description of J01.)

- Motor stopped due to slow flowrate under PID control -- **PID-STP**  
(Function code data = 44)

This output signal comes ON when the inverter is stopped by the slow flowrate stop function under PID control. (Refer to the descriptions of J15 through J17.)

 **Note** When PID control is enabled, the inverter may stop due to the slow flowrate stop function or other reasons, with the **PID-CTL** signal being ON. As long as the **PID-CTL** signal is ON, PID control is effective, so the inverter may abruptly resume its operation, depending on the PID feedback value.

### **WARNING**

When PID control is enabled, even if the inverter stops its output during operation because of sensor signals or other reasons, operation will resume automatically.

Design your machinery so that safety is ensured even in such cases.

**Otherwise, an accident could occur.**

- Switched to motor 2 -- **SWM2**  
(Function code data = 49)

This output signal comes ON when motor 2 is selected with the **M2/MI** terminal command assigned to a digital input terminal. For details, refer to the descriptions of E01 through E03 (Function code data = 12).

- Motor overheat detected by thermistor (PTC) -- **THM**  
(Function code data = 56)

When the thermistor is enabled (H26 = 2), this output signal comes ON if the motor temperature rises to the protection trigger level specified by H27.

- Brake signal -- **BRKS**  
(Function code data = 57)

This signal outputs a brake control command that releases or activates the brake. Refer to the descriptions of J68 through J72.

- Terminal [C1] wire break -- **C1OFF**  
(Function code data = 59)

When terminal [C1] is used for a feedback signal under PID control, this output signal comes ON if the [C1] wire breaks, thereby enabling it to activate the protection function.

- Maintenance timer -- **MNT**  
(Function code data = 84)

Once the inverter's cumulative run time or the number of startup times for motor 1 exceeds the previously specified count, this output signal comes ON.

 Refer to H78 and H79.

- Frequency arrival detected -- **FARFDT**  
(Function code data = 87)

The **FARFDT**, which is an ANDed signal of **FAR** and **FDT**, comes ON when both signal conditions are met.

- Alarm output (for any alarm) -- **ALM**  
(Function code data = 99)

This output signal comes ON if any of the protective functions is activated and the inverter enters Alarm mode.

**E30 Frequency Arrival (Hysteresis width for FAR)**

E30 specifies the detection level (hysteresis width) for **FAR** ("Frequency arrival signal"). The moment the output frequency reaches the zone defined by "Reference frequency ± Hysteresis width specified by E30," the **FAR** comes ON.

The operation timings of signals are shown in the graph below.

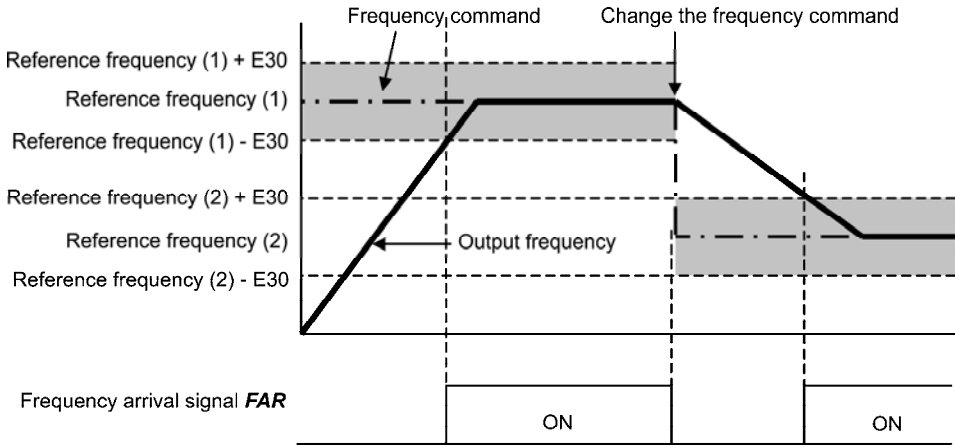

**E31 Frequency Detection (Detection level for FDT)**

**E32 Frequency Detection (Hysteresis width for FDT)**

When the output frequency exceeds the frequency detection level specified by E31, the **FDT** signal ("Frequency detected") comes ON; when it drops below the "Frequency detection level minus Hysteresis width specified by E32," it goes OFF.

You need to assign the **FDT** (function code data = 2) to one of digital output terminals.

- Data setting range: 0.0 to 400.0 (Hz)

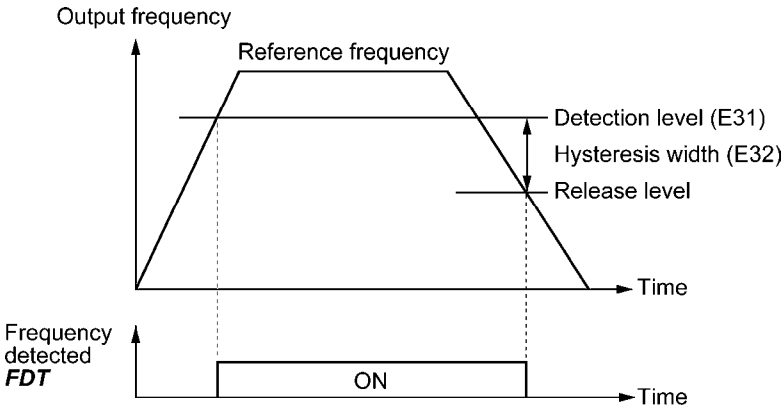

The **FARFDT** is an ANDed signal of **FAR** and **FDT**.

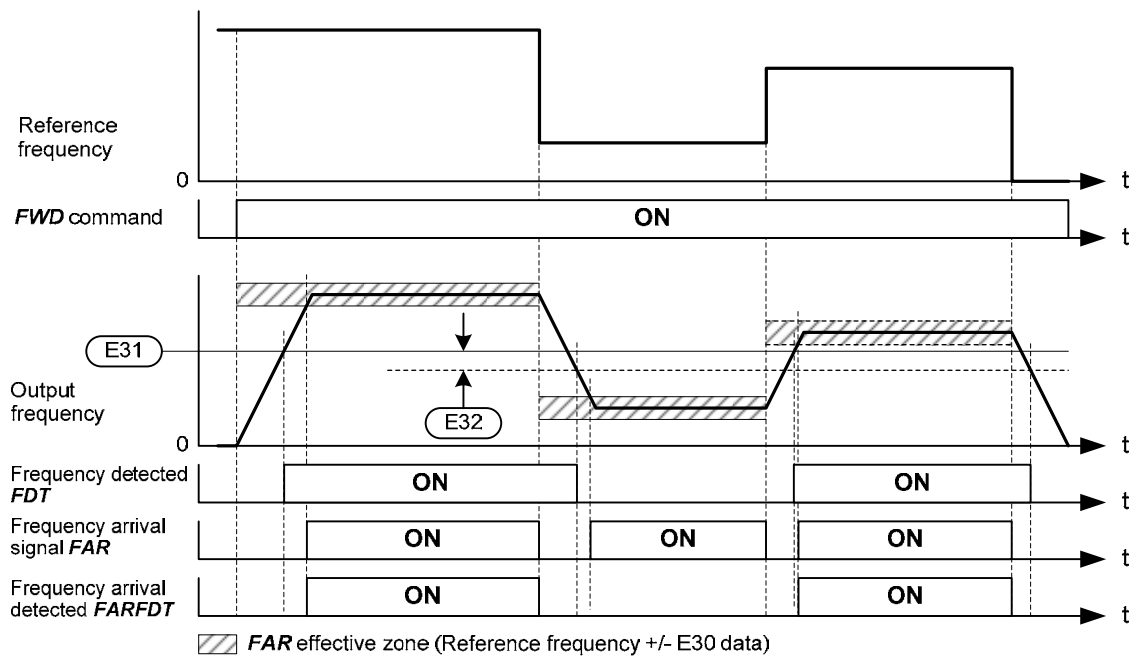

<b>E34</b>	<b>Overload Early Warning/Low Current Detection (Level)</b>
<b>E35</b>	<b>Overload Early Warning/Low Current Detection (Timer)</b>
<b>E37</b>	<b>Current Detection 2 (Level)</b>
<b>E38</b>	<b>Current Detection 2 (Timer)</b>

These function codes define the detection level and timer for the **OL** ("Motor overload early warning"), **ID** ("Current detected"), **ID2** ("Current detected 2") and **IDL** ("Low current detected") output signals.

Output signal	Data assigned to output terminal	Detection level	Timer	Motor characteristics	Thermal time constant
		Range: See below	Range: 0.01 to 600.00 s	Range: See below	Range: 0.5 to 75.0 min
<b>OL</b>	7	E34	--	F10	F12
<b>ID</b>	37	E34	E35	--	--
<b>ID2</b>	38	E37	E38		
<b>IDL</b>	41	E34	E35		

- Data setting range

Operation level: 0.00 (Disable), 1 to 200% of inverter rated current

Motor characteristics 1: Enable (For a general-purpose motor and Fuji standard permanent magnet synchronous motor with shaft-driven cooling fan)

2: Enable (For an inverter-driven motor with separately powered cooling fan)

■ Motor overload early warning signal -- **OL**

The **OL** signal is used to detect a symptom of an overload condition (alarm code  $\overline{OL}$ ) of the motor so that the user can take an appropriate action before the alarm actually happens.

The **OL** signal turns ON when the inverter output current has exceeded the level specified by E34. In typical cases, set E34 data to 80 to 90% against F11 data (Electronic thermal overload protection for motor 1, Overload detection level). Specify also the thermal characteristics of the motor with F10 (Select motor characteristics) and F12 (Thermal time constant). To utilize this feature, you need to assign **OL** (data = 7) to any of the digital output terminals.

■ Current detected and Current detected 2 signals -- **ID** and **ID2**

When the inverter output current has exceeded the level specified by E34 or E37 and it continues longer than the period specified by E35 or E38, the **ID** or **ID2** signal turns ON, respectively. When the output current drops below 90% of the rated operation level, the **ID** or **ID2** turns OFF. (Minimum width of the output signal: 100 ms)

To utilize this feature, you need to assign **ID** (data = 37) or **ID2** (data = 38) to any of digital output terminals.

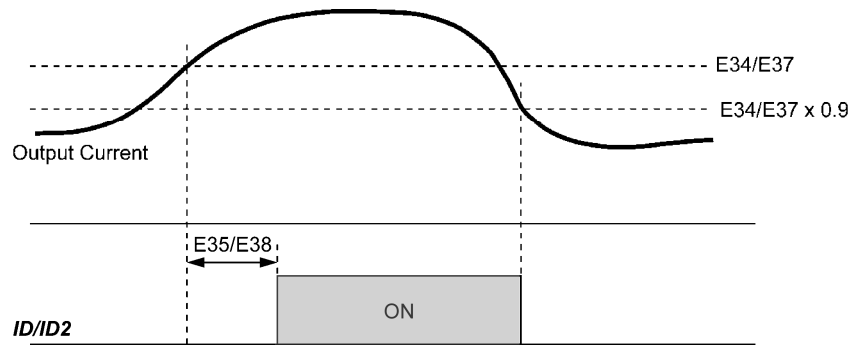

■ Low current detected -- **IDL**

This signal turns ON when the output current drops below the low current detection level (E34) and remains at the low level for the timer period (E35). When the output current exceeds the "Low current detection level plus 5% of the inverter rated current," it goes OFF. (The minimum ON-duration is 100 ms.)

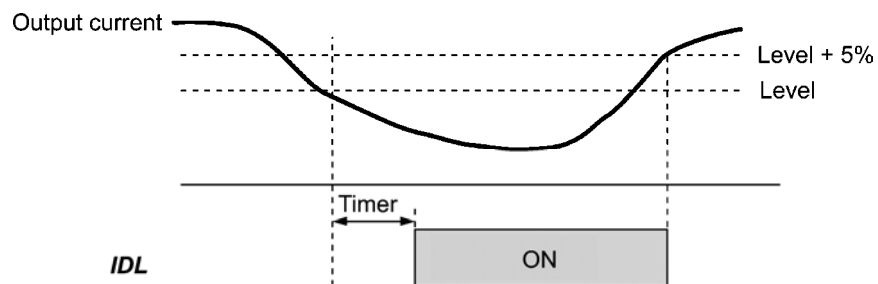

<b>E39</b>	<b>Coefficient for Constant Feeding Rate Time</b> <b>E50 (Coefficient for Speed Indication)</b>
------------	--

E39 and E50 specify coefficients for determining the constant feeding rate time, load shaft speed, and line speed, as well as for displaying the output status monitored.

Calculation expression

$$\text{Constant feeding rate time (min)} = \frac{\text{Coefficient for speed indication (E50)}}{\text{Frequency} \times \text{Coefficient for constant feeding rate time (E39)}}$$

$$\text{Load shaft speed} = \text{Coefficient for speed indication (E50)} \times \text{Frequency (Hz)}$$

$$\text{Line speed} = \text{Coefficient for speed indication (E50)} \times \text{Frequency (Hz)}$$

Where, the "frequency" refers to the "reference frequency" to be applied for settings (constant feeding rate time, load shaft speed, or line speed), or to the "output frequency before slip compensation" to be applied for monitor.

If the constant feeding rate time is 999.9 min. or more or the denominator of the right-hand side is zero (0), "999.9" appears.

<b>E40</b>	<b>PID Display Coefficient A</b>
------------	----------------------------------

<b>E41</b>	<b>PID Display Coefficient B</b>
------------	----------------------------------

These function codes specify PID display coefficients A and B to convert a PID command and its feedback into easy-to-understand physical quantities to display.

- Data setting range: -999 to 0.00 to 9990 for PID display coefficients A and B.

■ Display coefficients for PID process command and its feedback (J01 = 1 or 2)

E40 specifies coefficient A that determines the display value at 100% of the PID process command or its feedback, and E41 specifies coefficient B that determines the display value at 0%.

The display value is determined as follows:

$$\text{Display value} = (\text{PID process command or its feedback (\%)} / 100) \times (\text{Display coefficient A} - \text{B}) + \text{B}$$

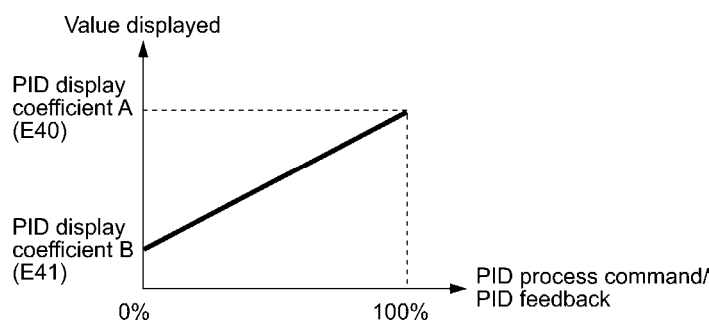

Example

Maintaining the pressure around 16 kPa (sensor voltage 3.13 V) while the pressure sensor can detect 0 to 30 kPa over the output voltage range of 1 to 5 V:

Select terminal [12] as a feedback terminal and set the gain to 200% so that 5 V corresponds to 100%.





The following E40 and E41 settings allow you to monitor or specify the values of the PID process command and its feedback on the keypad as pressure.

PID display coefficient A (E40) = 30.0, that determines the display value at 100% of PID process command or its feedback

PID display coefficient B (E41) = -7.5, that determines the display value at 0% of PID process command or its feedback

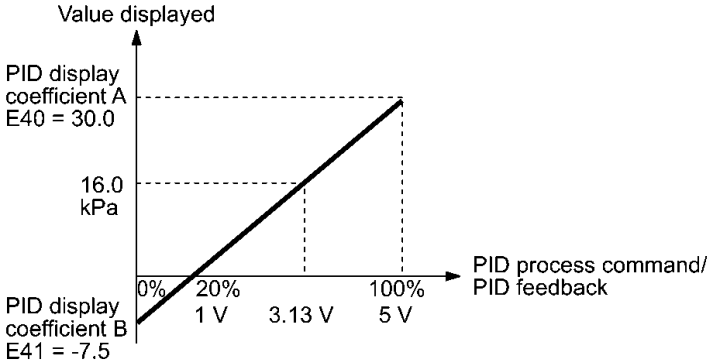
To control the pressure at 16 kPa on the keypad, set the value to 16.0.



-  For details about the PID control, refer to the description of J01 and later.
-  For the display method of the PID command and its feedback, refer to the description of E43.

<b>E42</b>	<b>LED Display Filter</b>
------------	---------------------------

E42 specifies a filter time constant to be applied for displaying the monitored running status such as output current and calculated torque. If the display varies unstably so as to be hard to read due to load fluctuation or other causes, increase this filter time constant.

<b>E43</b>	<b>LED Monitor (Item selection)</b>	<b>E48 (LED Monitor, Item selection)</b>
------------	-------------------------------------	--

E43 specifies the monitoring item to be displayed on the LED monitor.

Data for E43	Function (Displays the following.)	Description
0	Speed monitor	Selected by the sub item of function code E48
3	Output current	Inverter output current expressed in RMS (A)
4	Output voltage	Inverter output voltage expressed in RMS (V)
9	Input power	Inverter's input power (kW)
10	PID command value (final) *	Refer to E40 and E41.
12	PID feedback amount *	Refer to E40 and E41.
13	Timer value (for timer operation)	Remaining time of timer operation specified (s)
14	PID output	PID output in % as the maximum frequency (F03) being at 100%
25	Input watt-hour	$\frac{\text{Input watt-hour (kWh)}}{100}$

\* When J01 = 0 (Disable), "- - -" appears on the LED monitor.

Specifying the speed monitor with E43 provides a choice of speed-monitoring formats selectable with E48 (LED Monitor).

Define the speed-monitoring format on the LED monitor as listed below.

Data for E48	Display format of the sub item	
0	Output frequency (before slip compensation)	Expressed in Hz
1	Output frequency (after slip compensation)	Expressed in Hz
2	Reference frequency	Expressed in Hz
4	Load shaft speed (r/min)	Coefficient for speed indication (E50) × Frequency (Hz)
5	Line speed (m/min)	Coefficient for speed indication (E50) × Frequency (Hz)
6	Constant feeding rate time (min)	Coefficient for speed indication (E50) ÷ (Frequency (Hz) × Coefficient for constant feeding rate time (E39))

<b>E48</b>	<b>LED Monitor (Speed monitor item)</b>	<b>E43 (LED Monitor, Item selection)</b>
------------	---	--

Refer to the description of E43.

<b>E50</b>	<b>Coefficient for Speed Indication</b>	<b>E39 (Coefficient for Constant Feeding Rate Time)</b>
------------	---	---

Refer to the description of E39.

<b>E51</b>	<b>Display Coefficient for Input Watt-hour Data</b>
------------	---

E51 specifies a display coefficient (multiplication factor) for displaying the input watt-hour data (5.17) in a part of maintenance information on the keypad.

Input watt-hour data = Display coefficient (E51 data) × Input watt-hour (kWh)

 **Note** Setting E51 data to 0.000 clears the input watt-hour and its data to "0." After clearing, be sure to restore E51 data to the previous value; otherwise, input watt-hour data will not be accumulated.

<b>E52</b>	<b>Keypad (Menu display mode)</b>
------------	-----------------------------------

E52 provides a choice of three menu display modes for the keypad as listed below.

Data for E52	Menu display mode	Menus to be displayed
0	Function code data editing mode	Menu #1
1	Function code data check mode	Menu #2
2	Full-menu mode	Menus #1 through #6 *

\* Menus #1 through #7 when a remote keypad is connected.

The menus available on the standard keypad are described below.

Menu	LED monitor shows:	Menu	Main functions
#1	F--	"Data Setting" F to y	Selecting each of these function code groups F to y enables its data to be displayed/changed.
#2	C.F.P	"Data Checking"	Displays only function codes that have been changed from their factory defaults. You can refer to or change those function code data.
#3	D.F.E	"Drive Monitoring"	Displays the running information required for maintenance or test running.
#4	I.O	"I/O Checking"	Displays external interface information.
#5	S.C.H.E	"Maintenance Information"	Displays maintenance information including accumulated run time.
#6	E.A.L	"Alarm Information"	Displays the latest four alarm codes. You can refer to the running information at the time when the alarm occurred.

 For details of each menu item, refer to Chapter 3 "OPERATION USING THE KEYPAD."

<b>E60</b>	<b>Built-in Potentiometer (Function selection)</b>
<b>E61</b>	<b>Terminal [12] Extended Function</b>
<b>E62</b>	<b>Terminal [C1] Extended Function</b>

E60 through E62 define the property of the built-in potentiometer and terminals [12] and [C1], respectively

There is no need to set up the potentiometer and terminals if they are to be used for frequency command sources.

Data for E60, E61, or E62	Function	Description
0	None	--
1	Auxiliary frequency command 1	This is an auxiliary analog frequency input to be added to frequency command 1 (F01). It is never added to frequency command 2, multistep frequency command or other frequency commands.
2	Auxiliary frequency command 2	This is an auxiliary analog frequency input to be added to all frequency commands including frequency command 1, frequency command 2 and multistep frequency commands.
3	PID command 1	This input includes temperature, pressure or other commands to apply under the PID control. Function code J02 should be also configured.
5	PID feedback amount	This input includes the feedback of the temperature or pressure under the PID control. (Not available for E60.)

**Note** If the built-in potentiometer and different terminals have been set up to hold the same data, the operation priority is given in the following order:

E60 > E61 > E62

Selecting the *UP/DOWN* control (F01, C30 = 7) ignores auxiliary frequency command 1 and 2.

<b>E98</b>	<b>Terminal [FWD] Function</b>	<b>E01 to E03 (Terminal [X1] to [X3] Function)</b>
<b>E99</b>	<b>Terminal [REV] Function</b>	<b>E01 to E03 (Terminal [X1] to [X3] Function)</b>

For details about command assignment to terminals [FWD] and [REV], refer to the descriptions of E01 to E03.

### 9.2.3 C codes (Control functions)

C01 to C03 C94 to C96	Jump Frequency 1, 2 and 3 Jump Frequency 4, 5 and 6
C04	Jump Frequency (Hysteresis width)

These function codes enable the inverter to jump over six different points on the output frequency in order to skip resonance caused by the motor speed and natural frequency of the driven machinery (load).

- When the inverter is increasing the reference frequency, the moment the reference frequency reaches the bottom of the jump frequency band, the inverter keeps the output at that bottom frequency. When the reference frequency exceeds the upper limit of the jump frequency band, the internal reference frequency takes on the value of the reference frequency. When the inverter is decreasing the reference frequency, the situation will be reversed.
- When more than two jump frequency bands overlap, the inverter actually takes the lowest frequency within the overlapped bands as the bottom frequency and the highest as the upper limit. Refer to the figure on the lower right.

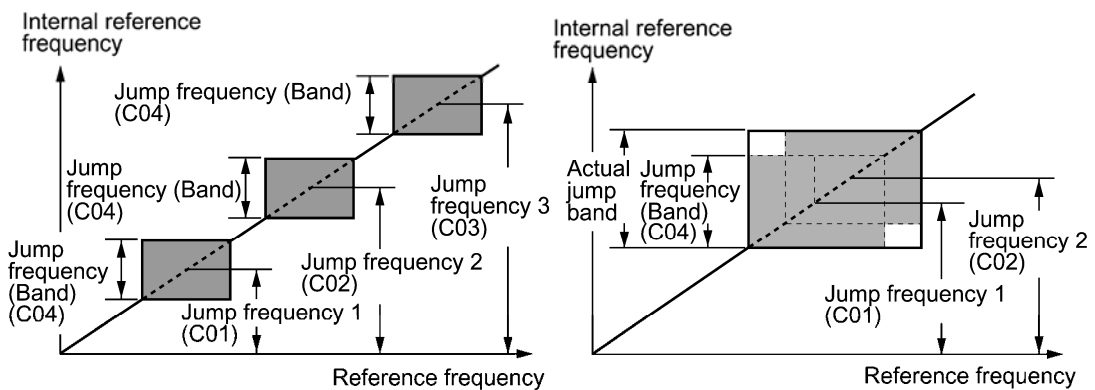

- Jump frequencies 1, 2 and 3 (C01, C02 and C03)
- Jump frequencies 4, 5 and 6 (C94, C95 and C96) \*1

Specify the center of the jump frequency band.

- Data setting range: 0.0 to 400.0 (Hz) (Setting to 0.0 results in no jump frequency band.)

- Jump frequency hysteresis width (C04)

Specify the jump frequency hysteresis width.

- Data setting range: 0.0 to 30.0 (Hz) (Setting to 0.0 results in no jump frequency band.)

\*1 Available in the ROM version 0500 or later.

**C05 to C19****Multistep Frequency 1 to 15**

These function codes specify 15 frequencies to apply when switching frequencies by turning terminal commands *SS1*, *SS2*, *SS4* and *SS8* ON or OFF selectively, as listed below.

Using this feature requires assigning *SS1*, *SS2*, *SS4* and *SS8* ("Select multistep frequency") to four out of five digital input terminals [X1] to [X3] (data = 0, 1, 2, and 3) beforehand. For details, refer to the descriptions of E01 to E03.

- Data setting range: 0.00 to 400.0 (Hz)

The combination of *SS1*, *SS2*, *SS4* and *SS8* and the selected frequencies are as follows.

<i>SS8</i>	<i>SS4</i>	<i>SS2</i>	<i>SS1</i>	Selected frequency command
OFF	OFF	OFF	OFF	Other than multistep frequency *
OFF	OFF	OFF	ON	C05 (multistep frequency 1)
OFF	OFF	ON	OFF	C06 (multistep frequency 2)
OFF	OFF	ON	ON	C07 (multistep frequency 3)
OFF	ON	OFF	OFF	C08 (multistep frequency 4)
OFF	ON	OFF	ON	C09 (multistep frequency 5)
OFF	ON	ON	OFF	C10 (multistep frequency 6)
OFF	ON	ON	ON	C11 (multistep frequency 7)
ON	OFF	OFF	OFF	C12 (multistep frequency 8)
ON	OFF	OFF	ON	C13 (multistep frequency 9)
ON	OFF	ON	OFF	C14 (multistep frequency 10)
ON	OFF	ON	ON	C15 (multistep frequency 11)
ON	ON	OFF	OFF	C16 (multistep frequency 12)
ON	ON	OFF	ON	C17 (multistep frequency 13)
ON	ON	ON	OFF	C18 (multistep frequency 14)
ON	ON	ON	ON	C19 (multistep frequency 15)

\* "Other than multistep frequency" includes frequency command 1 (F01), frequency command 2 (C30) and other command sources except multistep frequency commands.



For the relationship between multistep frequency operation and other frequency commands, refer to Section 4.2 "Drive Frequency Command Block."

■ When enabling PID control (J01 = 1, 2, or 3)

Even under PID control, a multistep frequency command can be specified as a preset value (3 different steps). It can also be used for a manual speed command even with PID control being canceled (*Hz/PID* = ON).

• PID command

<i>SS8</i>	<i>SS4</i>	<i>SS1, SS2</i>	Command
OFF	OFF	–	Command specified by J02
OFF	ON	–	Multistep frequency by C08
ON	OFF	–	Multistep frequency by C12
ON	ON	–	Multistep frequency by C16

C08, C12, and C16 can be specified in increments of 1 Hz. The following gives the conversion formula between the PID command value and the data to be specified.

$$\text{Data to be specified} = \text{PID command (\%)} \times \text{Maximum frequency (F03)} \div 100$$

$$\text{PID command (\%)} = \frac{\text{Data to be specified (C08/C12/C16)}}{\text{Maximum frequency (F03)}} \times 100$$

• Manual speed command

<i>SS8, SS4</i>	<i>SS2</i>	<i>SS1</i>	Selected frequency
–	OFF	OFF	Other than multistep frequency
–	OFF	ON	C05 (Multistep frequency 1)
–	ON	OFF	C06 (Multistep frequency 2)
–	ON	ON	C07 (Multistep frequency 3)



For PID commands, refer to the block diagrams in Chapter 4, Section 4.8 "PID Process Control Block."

<b>C20</b>	<b>Jogging Frequency</b>
------------	--------------------------

C20 specifies the frequency to apply in jogging (inching) operation.

- Data setting range: 0.00 to 400.0 (Hz)



For details about jogging operation, refer to the descriptions of E01 to E03 "Terminal [X1] to [X3] Function."

**C21****Timer Operation**

C21 enables or disables a timer operation that is triggered by a run command and continues for the timer count previously specified with the  $\triangleleft$  /  $\triangleright$  keys. The operating procedure for the timer operation is given below.

Data for C21	Function
0	Disable timer operation
1	Enable timer operation

- Tip**
- Pressing the  $\text{STOP}$  key during timer countdown quits the timer operation.
  - Even if C21 = 1, setting the timer to 0 no longer starts the timer operation with the  $\text{RUN}$  key.
  - Applying terminal command *FWD* or *REV* instead of the key command can also start the timer operation.

**Operating procedure for timer operation (example)****Preparation**

- To display the timer count on the LED monitor, set E43 (LED Monitor) to "13" (Timer) and C21 (Timer Operation) to "1" (Enable).
- Specify the reference frequency to apply to timer operation. When the keypad is selected as a frequency command source, press the  $\text{FUNC/DATA}$  key to shift to the speed monitor and specify the desired reference frequency.

**Triggering the timer operation with the  $\text{RUN}$  key**

- (1) While watching the timer count displayed on the LED monitor, press the  $\triangleleft$  /  $\triangleright$  key to set the timer for the desired count in seconds. Note that the timer count on the LED monitor appears as an integral number without a decimal point.
- (2) Press the  $\text{RUN}$  key. The motor starts running and the timer starts counting down. If the timer counts down, the motor stops without pressing the  $\text{STOP}$  key. (Even if the LED monitor displays any item except the timer count, the timer operation is possible.)

- Note** After the countdown of the timer operation triggered by a terminal command such as *FWD*, the inverter decelerates to stop and at that moment the LED monitor displays  $\text{Err}$  and any LED monitor item ( $\text{L}$  for the timer count) alternately. Turning *FWD* OFF returns to the LED monitor item.

**C30****Frequency Command 2****F01 (Frequency Command 1)**

For details of frequency command 2, refer to the description of F01.



<b>C32</b>	<b>Analog Input Adjustment for [12] (Gain)</b> F18 (Bias, Frequency command 1)
------------	---

Refer to the description of F18.

<b>C33</b>	<b>Analog Input Adjustment for Terminal [12] (Filter time constant)</b> C38 (Analog Input Adjustment for Terminal [C1], Filter time constant)
------------	--

C33 and C38 configure a filter time constant for an analog voltage and current input on terminals [12] and [C1], respectively.

- Data setting range: 0.00 to 5.00 (s)
- The larger the time constant, the slower the response. Specify the proper filter time constant taking into account the response speed of the machine (load). If the input voltage fluctuates due to line noise, remove the cause of the noise or take an electric circuit related measure. Only when no effect is obtained, increase the time constant.

<b>C34</b>	<b>Analog Input Adjustment for [12] (Gain base point)</b> F18 (Bias, Frequency command 1)
------------	--

Refer to the description of F18.

<b>C37</b>	<b>Analog Input Adjustment for Terminal [C1] (Gain)</b> F18 (Bias, Frequency command 1)
------------	--

Refer to the description of F18.

<b>C38</b>	<b>Analog Input Adjustment for Terminal [C1] (Filter time constant)</b> C31 (Analog Input Adjustment for Terminal [12], Offset)
------------	--

Refer to the description of C31.

<b>C39</b>	<b>Analog Input Adjustment for Terminal [C1] (Gain base point)</b> F18 (Bias, Frequency command 1)
------------	---

Refer to the description of F18.

<b>C40</b>	<b>Terminal [C1] Input Range</b>
------------	----------------------------------

C40 specifies the input range of terminal [C1] (analog input current).

Data for C40	Terminal [C1] input range
0	4 to 20 mA DC
1	0 to 20 mA DC

<b>C50</b>	<b>Bias (Frequency command 1) (Bias base point)</b> <b>F18 (Bias, Frequency command 1)</b>
------------	---

For details about bias base point setting for frequency command 1, refer to the description of F18.

<b>C51</b>	<b>Bias (PID command 1) (Bias value)</b>
------------	--

<b>C52</b>	<b>Bias (PID command 1) (Bias base point)</b>
------------	---

These function codes specify the gain and bias of the analog PID command 1, enabling it to define arbitrary relationship between the analog input and PID commands.



The actual setting is the same as that of function code F18. For details, refer to the description of F18.



Note that function codes C32, C34, C37 and C39 are shared by frequency commands.

- Bias value (C51)
  - Data setting range: -100.00 to 100.00 (%)
- Bias base point (C52)
  - Data setting range: 0.00 to 100.00 (%)

<b>C94 to C96</b>	<b>Jump Frequency 4, 5 and 6</b>	<b>C01 to C03 (Jump Frequency 1 to 3)</b>
-------------------	----------------------------------	---

For details about this function, refer to the description of C01.

<b>C99</b>	<b>Digital Reference Frequency</b>	<b>F01 (Frequency Command 1)</b>
------------	------------------------------------	----------------------------------

C99 displays the digital reference frequency specified from the keypad (when F01 = 0). The C99 data can be changed only via the communications link.

The copy function incorporated in the remote keypad or FRENIC Loader can copy the C99 data so that it is possible to copy the digital reference frequency.

C99 is available in the ROM version 0500 or later.

## 9.2.4 P codes (Motor 1 parameters)

<b>P02</b>	<b>Motor 1 (Rated capacity)</b>	<b>A16 (Motor 2, Rated capacity)</b>
------------	---------------------------------	--------------------------------------

P02 specifies the rated capacity of the motor. Enter the rated value given on the nameplate of the motor.

Data for P02	Unit	Dependency on P99
0.01 to 30.00	kW	When P99 = 0, 3, 4, 20 or 21
	HP	When P99 = 1

<b>P03</b>	<b>Motor 1 (Rated current)</b>	<b>A17 (Motor 2, Rated current)</b>
------------	--------------------------------	-------------------------------------

P03 specifies the rated current of the motor. Enter the rated value given on the nameplate of the motor.

- Data setting range: 0.00 to 100.0

<b>P04</b>	<b>Motor 1 (Auto-tuning)</b>	<b>A18 (Motor 2, Auto-tuning)</b>
------------	------------------------------	-----------------------------------

The inverter automatically detects the motor constants and saves them as parameters in its internal memory. Basically, no tuning is required as long as a Fuji standard motor is used with standard connection with the inverter.

In any of the following cases, however, perform auto-tuning since the motor parameters are different from standard ones so that the full performance may not be obtained under each of these controls--auto torque boost, torque calculation monitoring, auto energy saving operation, automatic deceleration (anti-regenerative control), slip compensation, and torque vector control.

- The motor to be driven is made by other manufacturer or is a non-standard motor.
- Cabling between the motor and the inverter is long.
- A reactor is inserted between the motor and the inverter.



For details of auto-tuning, refer to the FRENIC-Mini Instruction Manual (INR-SI47-1729-E), Section 4.1.3 "Preparation before a test run--Configuring function code data."

<b>P06</b>	<b>Motor 1 (No-load current)</b>	<b>P12 (Motor 1, Rated slip frequency) A20 (Motor 2, No-load current)</b>
<b>P07</b>	<b>Motor 1 (%R1)</b>	<b>A21 (Motor 2, %R1)</b>
<b>P08</b>	<b>Motor 1 (%X)</b>	<b>A22 (Motor 2, %X)</b>

P06 through P08 and P12 specify no-load current, %R1, %X, and rated slip frequency, respectively. Obtain the appropriate values from the test report of the motor or by calling the motor manufacturer.

Performing auto-tuning automatically sets these parameters.

■ **No-load current (P06)**

Enter the value obtained from the motor manufacturer.

■ **%R1 (P07)**

Enter the value calculated by the following expression.

$$\%R1 = \frac{R1 + \text{Cable } R1}{V / (\sqrt{3} \times I)} \times 100 (\%)$$

where,

R1: Primary resistance of the motor ( $\Omega$ )

Cable R1: Resistance of the output cable ( $\Omega$ )

V: Rated voltage of the motor (V)

I: Rated current of the motor (A)

■ **%X (P08)**

Enter the value calculated by the following expression.

$$\%X = \frac{X1 + X2 \times XM / (X2 + XM) + \text{Cable } X}{V / (\sqrt{3} \times I)} \times 100 (\%)$$

where,

X1: Primary leakage reactance of the motor ( $\Omega$ )

X2: Secondary leakage reactance of the motor (converted to primary) ( $\Omega$ )

XM: Exciting reactance of the motor ( $\Omega$ )

Cable X: Reactance of the output cable ( $\Omega$ )

V: Rated voltage of the motor (V)

I: Rated current of the motor (A)

■ **Rated slip frequency (P12)**

Convert the value obtained from the motor manufacturer to Hz using the following expression and enter the converted value. (Note: The motor rating given on the nameplate sometimes shows a larger value.)

$$\text{Rated slip frequency (Hz)} = \frac{(\text{Synchronous speed} - \text{Rated speed})}{\text{Synchronous speed}} \times \text{Base frequency}$$

 For reactance, choose the value at the base frequency 1 (F04).

<b>P09</b>	<b>Motor 1 (Slip compensation gain for driving)</b> A23 (Motor 2, Slip compensation gain for driving)
<b>P10</b>	<b>Motor 1 (Slip compensation response time)</b> A24 (Motor 2, Slip compensation response time)
<b>P11</b>	<b>Motor 1 (Slip compensation gain for braking)</b> A25 (Motor 2, Slip compensation gain for braking)

P09 and P11 determine the slip compensation amount in % for driving and braking, respectively. Specification of 100% fully compensates for the rated slip of the motor. Excessive compensation (P09, P11 > 100%) may cause hunting (undesirable oscillation of the system), so carefully check the operation on the actual machine.

P10 determines the response time for slip compensation. Basically, there is no need to modify the default setting. If you need to modify it, consult your Fuji Electric representatives.

<b>P12</b>	<b>Motor 1 (Rated slip frequency)</b> P06 (Motor 1, No-load current) P07 (Motor 1, %R1) P08 (Motor 1, %X) A26 (Motor 2, Rated slip frequency)
------------	---

For details about setting of the rated slip frequency of motor 1, refer to the descriptions of P06 to P08.

<b>P99</b>	<b>Motor 1 Selection</b> A39 (Motor 2 Selection)
------------	---

P99 specifies the type of motor 1 to be used.

Data for P99	Motor type
0	Motor characteristics 0 (Fuji standard IM, 8-series)
1	Motor characteristics 1 (HP rating IM. Typical in North America)
3	Motor characteristics 3 (Fuji standard IM, 6-series)
4	Other motors (IM)
20	Other motors (PMSM)
21	Fuji standard PMSM without sensor (GNB series)

Automatic control (such as auto torque boost and auto energy saving) or electronic thermal overload protection for motor uses the motor parameters and characteristics. To match the property of a control system with that of the motor, select characteristics of the motor and set H03 data (Data Initialization) to "2" to initialize the motor parameters stored in the inverter. The initialization automatically updates the P03 and P06 to P12 data and the constants used inside the inverter.

According to the motor model, set the P99 data as shown below.

- For Fuji standard IM, 8-series (Current standard induction motors), P99 = 0
- For Fuji standard IM, 6-series (Conventional standard induction motors), P99 = 3
- For other manufacturers' IM or model-unknown IM, P99 = 4
- For PMSM, P99 = 20 or 21 (to be selected after consultation with motor manufacturers)

- Note**
- When P99 = 4, the inverter runs following the motor characteristics of Fuji standard IM, 8-series.
  - When P99 = 1, the inverter applies to the characteristics of HP rating IM (Typical in North America).

Given below are motor parameters for driving a permanent magnet synchronous motor (PMSM). When driving an induction motor (IM), no setting is required for those parameters. Refer to Section 9.3 "Notes in Driving PMSM."

<b>P60</b>	<b>Motor 1 (PMSM: Armature resistance)</b>
<b>P61</b>	<b>Motor 1 (PMSM: d-axis inductance)</b>
<b>P62</b>	<b>Motor 1 (PMSM: q-axis inductance)</b>
<b>P63</b>	<b>Motor 1 (PMSM: Induced voltage)</b>

To drive a PMSM, it is necessary to configure a total of seven motor parameters correctly--the above four motor parameters and three parameters of F04 (Base frequency 1), F05 (Rated voltage at base frequency 1) and P03 (Motor 1 rated current).

Be sure to consult the motor manufacturer and configure motor parameters correctly. Incorrect motor parameters may result in a motor or inverter failure.

The factory defaults of P60 through P63 are "0." When any one of P60, P62 and P63 is "0" (factory default), setting F42 (Control mode selection 1) to "11" (V/f control for PMSM drive) cannot start the inverter.

<b>P74</b>	<b>Motor 1 (PMSM: Reference current at starting)</b>
<b>P89</b>	<b>Motor 1 (PMSM: Control switching level)</b>
<b>P90</b>	<b>Motor 1 (PMSM: Overcurrent protection level)</b>
<b>P91</b>	<b>Motor 1 (PMSM: d-axis compensation gain under damping control)</b>
<b>P92</b>	<b>Motor 1 (PMSM: q-axis compensation gain under damping control)</b>
<b>P93</b>	<b>Motor 1 (PMSM: Step-out detection current level)</b>

The above six parameters do not require any change basically. Only when any change is requested by the motor manufacturer, make parameter settings.

## 9.2.5 H codes (High performance functions)

H03	Data Initialization
-----	---------------------

H03 initializes the current function code data to the factory defaults or initializes the motor parameters.

To change the H03 data, it is necessary to press the  $\text{STOP} + \text{▲}$  keys or  $\text{STOP} + \text{▼}$  keys (simultaneous keying).

Data for H03	Function
0	Disable initialization (Settings manually made by the user will be retained.)
1	Initialize all function code data to the factory defaults
2	Initialize motor 1 parameters in accordance with P02 (Rated capacity) and P99 (Motor 1 selection) Function codes subject to initialization: P03, P06 to P12 and constants for internal control (These function codes will be initialized to the values listed in tables on the following pages.)
3	Initialize motor 2 parameters in accordance with A16 (Rated capacity) and A39 (Motor 2 selection) Function codes subject to initialization: A17, A20 to A26 and constants for internal control (These function codes will be initialized to the values listed in tables on the following pages.)

- To initialize the motor parameters, set the related function codes using the following steps.
  - (1) P02/A16 Motor (Rated capacity) Set the rated capacity of the motor to be used in kW.
  - (2) P99/A39 Motor Selection Select the characteristics of the motor.
  - (3) H03 Data Initialization Initialize the motor parameters. (H03 = 2 or 3)
  - (4) P03/A17 Motor (Rated current) Set the rated current on the nameplate if the already set data differs from the rated current printed on the nameplate of the motor.
- Upon completion of the initialization, the H03 data reverts to "0" (factory default).
- If the P02 or A16 data is set to a value other than the nominal applied motor rating, data initialization with H03 internally converts the specified value forcedly to the equivalent nominal applied motor rating (see the tables on the following pages).
- If initialized, motor parameters revert to the default data specified for each of the V/f settings listed below. To use motors whose base frequency, rated voltage or number of poles is different, non-Fuji motors, or other series of motors, change the data to the rated current printed on the nameplate.
  - P99 = 0 or 4 : Fuji standard IM, 8-series
  - P99 = 3 : Fuji standard IM, 6-series
  - P99 = 1 : HP rating IM (4 poles, 230 V/60 Hz or 460 V/60 Hz)
- When a PMSM is selected (P99 = 20 or 21), initializing motor parameters by setting the H03 data to "2" reverts function code data for both IM and PMSM to factory defaults.

- When Fuji standard 8-series IM (P99 = 0 or A39 = 0) or other motors (P99 = 4 or A39 = 4) are selected, the motor parameters are as listed in the following tables.

200 V class series for Asia version (FRN\_ \_ \_ \_C2S-2A, FRN\_ \_ \_ \_C2■-7A)

220 V, 60 Hz, rated voltage, base frequency, Fuji standard 8-series

Motor capacity (kW)	Nominal applied motor (kW)	Rated current (A)	No-load current (A)	%R1 (%)	%X1 (%)	Rated slip frequency (Hz)
P02/A16		P03/A17	P06/A20	P07/A21	P08/A22	P12/A26
0.01 to 0.09	0.06	0.40	0.37	11.40	9.71	1.77
0.10 to 0.19	0.1	0.62	0.50	10.74	10.50	1.77
0.20 to 0.39	0.2	1.18	0.97	10.69	10.66	2.33
0.40 to 0.74	0.4	2.10	1.52	8.47	11.34	2.40
0.75 to 1.49	0.75	3.29	2.11	7.20	8.94	2.33
1.50 to 2.19	1.5	5.56	2.76	5.43	9.29	2.00
2.20 to 3.69	2.2	8.39	4.45	5.37	9.09	1.80
3.70 to 5.49	3.7	13.67	7.03	4.80	9.32	1.93
5.50 to 7.49	5.5	20.50	10.08	4.37	11.85	1.40
7.50 to 10.99	7.5	26.41	11.46	3.73	12.15	1.57
11.00 to 14.99	11	38.24	16.23	3.13	12.49	1.07
15.00 to 18.49	15	50.05	18.33	2.69	13.54	1.13
18.50 to 21.99	18.5	60.96	19.62	2.42	13.71	0.87
22.00 to 29.99	22	70.97	23.01	2.23	13.24	0.90
30.00	30	97.38	35.66	2.18	12.38	0.80

400 V class series for Asia version (FRN\_ \_ \_ \_C2■-4A)

380 V, 60 Hz, rated voltage, base frequency, Fuji standard 8-series

Motor capacity (kW)	Nominal applied motor (kW)	Rated current (A)	No-load current (A)	%R1 (%)	%X1 (%)	Rated slip frequency (Hz)
P02/A16		P03/A17	P06/A20	P07/A21	P08/A22	P12/A26
0.01 to 0.09	0.06	0.19	0.16	12.54	10.68	1.77
0.10 to 0.19	0.10	0.31	0.21	12.08	11.81	1.77
0.20 to 0.39	0.20	0.58	0.42	12.16	12.14	2.33
0.40 to 0.74	0.4	1.07	0.66	9.99	13.38	2.40
0.75 to 1.49	0.75	1.72	0.91	8.72	10.82	2.33
1.50 to 2.19	1.5	3.10	1.20	6.89	11.80	2.00
2.20 to 3.69	2.2	4.54	1.92	6.73	11.40	1.80
3.70 to 5.49	3.7	7.43	3.04	6.04	11.73	1.93
5.50 to 7.49	5.5	11.49	4.35	5.55	15.05	1.40
7.50 to 10.99	7.5	14.63	4.95	4.78	15.59	1.57
11.00 to 14.99	11	21.23	7.01	4.02	16.06	1.07
15.00 to 18.49	15	28.11	7.92	3.50	17.61	1.13
18.50 to 21.99	18.5	35.01	8.47	3.16	17.97	0.87
22.00 to 29.99	22	40.11	9.98	2.92	17.32	0.90
30.00	30	55.21	15.44	2.84	16.10	0.80

A box (■) in the above inverter types replaces S (Basic type) or E (EMC filter built-in type) depending on the enclosure.



200 V class series for China version (FRN\_ \_ \_ C2■-7C)

200 V, 50 Hz, rated voltage, base frequency, Fuji standard 8-series

Motor capacity (kW)	Nominal applied motor (kW)	Rated current (A)	No-load current (A)	%R1 (%)	%X1 (%)	Rated slip frequency (Hz)
P02/A16		P03/A17	P06/A20	P07/A21	P08/A22	P12/A26
0.01 to 0.09	0.06	0.44	0.40	13.79	11.75	1.77
0.10 to 0.19	0.1	0.68	0.55	12.96	12.67	1.77
0.20 to 0.39	0.2	1.30	1.06	12.95	12.92	2.33
0.40 to 0.74	0.4	2.30	1.66	10.20	13.66	2.40
0.75 to 1.49	0.75	3.60	2.30	8.67	10.76	2.33
1.50 to 2.19	1.5	6.10	3.01	6.55	11.21	2.00
2.20 to 3.69	2.2	9.20	4.85	6.48	10.97	1.80
3.70 to 5.49	3.7	15.00	7.67	5.79	11.25	1.93
5.50 to 7.49	5.5	22.50	11.00	5.28	14.31	1.40
7.50 to 10.99	7.5	29.00	12.50	4.50	14.68	1.57
11.00 to 14.99	11	42.00	17.70	3.78	15.09	1.07
15.00 to 18.49	15	55.00	20.00	3.25	16.37	1.13
18.50 to 21.99	18.5	67.00	21.40	2.92	16.58	0.87
22.00 to 29.99	22	78.00	25.10	2.70	16.00	0.90
30.00	30	107.0	38.90	2.64	14.96	0.80

400 V class series for China version (FRN\_ \_ \_ C2■-4C)

380 V, 50 Hz, rated voltage, base frequency, Fuji standard 8-series

Motor capacity (kW)	Nominal applied motor (kW)	Rated current (A)	No-load current (A)	%R1 (%)	%X1 (%)	Rated slip frequency (Hz)
P02/A16		P03/A17	P06/A20	P07/A21	P08/A22	P12/A26
0.01 to 0.09	0.06	0.21	0.19	13.86	11.81	1.77
0.10 to 0.19	0.10	0.34	0.26	13.25	12.96	1.77
0.20 to 0.39	0.20	0.64	0.50	13.42	13.39	2.33
0.40 to 0.74	0.4	1.15	0.79	10.74	14.38	2.40
0.75 to 1.49	0.75	1.82	1.09	9.23	11.45	2.33
1.50 to 2.19	1.5	3.20	1.43	7.12	12.18	2.00
2.20 to 3.69	2.2	4.72	2.31	7.00	11.85	1.80
3.70 to 5.49	3.7	7.70	3.65	6.26	12.16	1.93
5.50 to 7.49	5.5	11.84	5.23	5.72	15.51	1.40
7.50 to 10.99	7.5	15.00	5.94	4.90	15.98	1.57
11.00 to 14.99	11	21.73	8.41	4.12	16.44	1.07
15.00 to 18.49	15	28.59	9.50	3.56	17.92	1.13
18.50 to 21.99	18.5	35.46	10.17	3.21	18.20	0.87
22.00 to 29.99	22	40.66	11.97	2.96	17.56	0.90
30.00	30	56.15	18.53	2.89	16.37	0.80

A box (■) in the above inverter types replaces S (Basic type) or E (EMC filter built-in type) depending on the enclosure.

200 V class series for Europe version (FRN\_ \_ \_ \_C2■-7E)

230 V, 50 Hz, rated voltage, base frequency, Fuji standard 8-series

Motor capacity (kW)	Nominal applied motor (kW)	Rated current (A)	No-load current (A)	%R1 (%)	%X1 (%)	Rated slip frequency (Hz)
P02/A16		P03/A17	P06/A20	P07/A21	P08/A22	P12/A26
0.01 to 0.09	0.06	0.49	0.46	13.35	11.38	1.77
0.10 to 0.19	0.1	0.73	0.63	12.10	11.83	1.77
0.20 to 0.39	0.2	1.38	1.22	11.95	11.93	2.33
0.40 to 0.74	0.4	2.36	1.91	9.10	12.19	2.40
0.75 to 1.49	0.75	3.58	2.65	7.50	9.30	2.33
1.50 to 2.19	1.5	5.77	3.46	5.39	9.22	2.00
2.20 to 3.69	2.2	8.80	5.58	5.39	9.12	1.80
3.70 to 5.49	3.7	14.26	8.82	4.79	9.30	1.93
5.50 to 7.49	5.5	21.25	12.65	4.34	11.75	1.40
7.50 to 10.99	7.5	26.92	14.38	3.63	11.85	1.57
11.00 to 14.99	11	38.87	20.36	3.04	12.14	1.07
15.00 to 18.49	15	50.14	23.00	2.58	12.98	1.13
18.50 to 21.99	18.5	60.45	24.61	2.29	13.01	0.87
22.00 to 29.99	22	70.40	28.87	2.12	12.56	0.90
30.00	30	97.54	44.74	2.09	11.86	0.80

400 V class series for Europe version (FRN\_ \_ \_ \_C2■-4E)

400 V, 50 Hz, rated voltage, base frequency, Fuji standard 8-series

Motor capacity (kW)	Nominal applied motor (kW)	Rated current (A)	No-load current (A)	%R1 (%)	%X1 (%)	Rated slip frequency (Hz)
P02/A16		P03/A17	P06/A20	P07/A21	P08/A22	P12/A26
0.01 to 0.09	0.06	0.22	0.20	13.79	11.75	1.77
0.10 to 0.19	0.10	0.35	0.27	12.96	12.67	1.77
0.20 to 0.39	0.20	0.65	0.53	12.95	12.92	2.33
0.40 to 0.74	0.4	1.15	0.83	10.20	13.66	2.40
0.75 to 1.49	0.75	1.80	1.15	8.67	10.76	2.33
1.50 to 2.19	1.5	3.10	1.51	6.55	11.21	2.00
2.20 to 3.69	2.2	4.60	2.43	6.48	10.97	1.80
3.70 to 5.49	3.7	7.50	3.84	5.79	11.25	1.93
5.50 to 7.49	5.5	11.50	5.50	5.28	14.31	1.40
7.50 to 10.99	7.5	14.50	6.25	4.50	14.68	1.57
11.00 to 14.99	11	21.00	8.85	3.78	15.09	1.07
15.00 to 18.49	15	27.50	10.00	3.25	16.37	1.13
18.50 to 21.99	18.5	34.00	10.70	2.92	16.58	0.87
22.00 to 29.99	22	39.00	12.60	2.70	16.00	0.90
30.00	30	54.00	19.50	2.64	14.96	0.80

A box (■) in the above inverter types replaces S (Basic type) or E (EMC filter built-in type) depending on the enclosure.

200 V class series, single-phase 100 V series for USA version  
(FRN\_ \_ \_ \_C2S-2U, FRN\_ \_ \_ \_C2S-7U, FRN\_ \_ \_ \_C2S-6U)

230 V, 60 Hz, rated voltage, base frequency, Fuji standard 8-series

Motor capacity (kW)	Nominal applied motor (kW)	Rated current (A)	No-load current (A)	%R1 (%)	%X1 (%)	Rated slip frequency (Hz)
P02/A16		P03/A17	P06/A20	P07/A21	P08/A22	P12/A26
0.01 to 0.09	0.06	0.42	0.38	11.45	9.75	1.77
0.10 to 0.19	0.1	0.63	0.53	10.44	10.21	1.77
0.20 to 0.39	0.2	1.21	1.02	10.48	10.46	2.33
0.40 to 0.74	0.4	2.11	1.59	8.14	10.90	2.40
0.75 to 1.49	0.75	3.27	2.20	6.85	8.50	2.33
1.50 to 2.19	1.5	5.44	2.88	5.08	8.69	2.00
2.20 to 3.69	2.2	8.24	4.65	5.05	8.54	1.80
3.70 to 5.49	3.7	13.40	7.35	4.50	8.74	1.93
5.50 to 7.49	5.5	20.06	10.54	4.09	11.09	1.40
7.50 to 10.99	7.5	25.72	11.98	3.47	11.32	1.57
11.00 to 14.99	11	37.21	16.96	2.91	11.63	1.07
15.00 to 18.49	15	48.50	19.17	2.49	12.55	1.13
18.50 to 21.99	18.5	58.90	20.51	2.23	12.68	0.87
22.00 to 29.99	22	68.57	24.05	2.06	12.23	0.90
30.00	30	94.36	37.28	2.02	11.47	0.80

400 V class series for USA version (FRN\_ \_ \_ \_C2S-4U)

460 V, 60 Hz, rated voltage, base frequency, Fuji standard 8-series

Motor capacity (kW)	Nominal applied motor (kW)	Rated current (A)	No-load current (A)	%R1 (%)	%X1 (%)	Rated slip frequency (Hz)
P02/A16		P03/A17	P06/A20	P07/A21	P08/A22	P12/A26
0.01 to 0.09	0.06	0.21	0.19	11.45	9.75	1.77
0.10 to 0.19	0.10	0.32	0.26	10.30	10.07	1.77
0.20 to 0.39	0.20	0.61	0.51	10.57	10.54	2.33
0.40 to 0.74	0.4	1.06	0.80	8.18	10.95	2.40
0.75 to 1.49	0.75	1.63	1.10	6.83	8.47	2.33
1.50 to 2.19	1.5	2.76	1.45	5.07	8.68	2.00
2.20 to 3.69	2.2	4.12	2.33	5.05	8.54	1.80
3.70 to 5.49	3.7	6.70	3.68	4.50	8.74	1.93
5.50 to 7.49	5.5	10.24	5.27	4.09	11.08	1.40
7.50 to 10.99	7.5	12.86	5.99	3.47	11.32	1.57
11.00 to 14.99	11	18.60	8.48	2.91	11.62	1.07
15.00 to 18.49	15	24.25	9.58	2.49	12.55	1.13
18.50 to 21.99	18.5	29.88	10.25	2.23	12.67	0.87
22.00 to 29.99	22	34.29	12.08	2.06	12.23	0.90
30.00	30	47.61	18.69	2.02	11.47	0.80

- When Fuji standard 6-series IM (P99 = 3 or A39 = 3) are selected, the motor parameters are as listed in the following tables.

200 V class series for Asia version (FRN\_ \_ \_ \_C2S-2A, FRN\_ \_ \_ \_C2■-7A)

220 V, 60 Hz, rated voltage, base frequency, Fuji standard 6-series

Motor capacity (kW)	Nominal applied motor (kW)	Rated current (A)	No-load current (A)	%R1 (%)	%X1 (%)	Rated slip frequency (Hz)
P02/A16		P03/A17	P06/A20	P07/A21	P08/A22	P12/A26
0.01 to 0.09	0.06	0.40	0.37	11.40	9.71	1.77
0.10 to 0.19	0.1	0.62	0.50	10.74	10.50	1.77
0.20 to 0.39	0.2	1.19	0.92	10.49	11.34	2.33
0.40 to 0.74	0.4	2.10	1.43	8.47	12.38	2.40
0.75 to 1.49	0.75	3.29	2.15	7.20	8.86	2.33
1.50 to 2.19	1.5	5.55	2.75	5.42	9.31	2.00
2.20 to 3.69	2.2	8.39	4.45	5.37	9.09	1.80
3.70 to 5.49	3.7	13.67	7.06	4.80	9.30	1.93
5.50 to 7.49	5.5	20.04	9.81	4.21	11.31	1.40
7.50 to 10.99	7.5	26.41	11.46	3.73	12.17	1.57
11.00 to 14.99	11	38.24	16.13	3.13	12.52	1.07
15.00 to 18.49	15	50.05	18.33	2.68	13.54	1.13
18.50 to 21.99	18.5	60.97	20.08	2.40	14.06	0.87
22.00 to 29.99	22	70.97	23.01	2.23	13.28	0.90
30.00	30	97.38	35.66	2.23	12.41	0.80

400 V class series for Asia version (FRN\_ \_ \_ \_C2S-4A)

380 V, 60 Hz, rated voltage, base frequency, Fuji standard 6-series

Motor capacity (kW)	Nominal applied motor (kW)	Rated current (A)	No-load current (A)	%R1 (%)	%X1 (%)	Rated slip frequency (Hz)
P02/A16		P03/A17	P06/A20	P07/A21	P08/A22	P12/A26
0.01 to 0.09	0.06	0.19	0.16	12.54	10.68	1.77
0.10 to 0.19	0.10	0.31	0.21	12.08	11.81	1.77
0.20 to 0.39	0.20	0.59	0.40	12.05	13.02	2.33
0.40 to 0.74	0.4	1.14	0.62	10.20	14.91	2.40
0.75 to 1.49	0.75	1.71	0.93	8.67	10.66	2.33
1.50 to 2.19	1.5	3.09	1.19	6.87	11.82	2.00
2.20 to 3.69	2.2	4.54	1.92	6.73	11.40	1.80
3.70 to 5.49	3.7	7.43	3.05	6.04	11.70	1.93
5.50 to 7.49	5.5	10.97	4.24	5.34	14.34	1.40
7.50 to 10.99	7.5	14.63	4.95	4.78	15.61	1.57
11.00 to 14.99	11	21.25	6.97	4.03	16.11	1.07
15.00 to 18.49	15	28.11	7.92	3.49	17.61	1.13
18.50 to 21.99	18.5	34.97	8.71	3.14	18.41	0.87
22.00 to 29.99	22	40.11	9.98	2.92	17.38	0.90
30.00	30	55.21	15.44	2.90	16.14	0.80

A box (■) in the above inverter types replaces S (Basic type) or E (EMC filter built-in type) depending on the enclosure.

200 V class series for China version (FRN\_ \_ \_ C2■-7C)

200 V, 50 Hz, rated voltage, base frequency, Fuji standard 6-series

Motor capacity (kW)	Nominal applied motor (kW)	Rated current (A)	No-load current (A)	%R1 (%)	%X1 (%)	Rated slip frequency (Hz)
P02/A16		P03/A17	P06/A20	P07/A21	P08/A22	P12/A26
0.01 to 0.09	0.06	0.44	0.40	13.79	11.75	1.77
0.10 to 0.19	0.1	0.68	0.55	12.96	12.67	1.77
0.20 to 0.39	0.2	1.30	1.00	12.61	13.63	2.33
0.40 to 0.74	0.4	2.30	1.56	10.20	14.91	2.40
0.75 to 1.49	0.75	3.60	2.35	8.67	10.66	2.33
1.50 to 2.19	1.5	6.10	3.00	6.55	11.26	2.00
2.20 to 3.69	2.2	9.20	4.85	6.48	10.97	1.80
3.70 to 5.49	3.7	15.00	7.70	5.79	11.22	1.93
5.50 to 7.49	5.5	22.00	10.70	5.09	13.66	1.40
7.50 to 10.99	7.5	29.00	12.50	4.50	14.70	1.57
11.00 to 14.99	11	42.00	17.60	3.78	15.12	1.07
15.00 to 18.49	15	55.00	20.00	3.24	16.37	1.13
18.50 to 21.99	18.5	67.00	21.90	2.90	17.00	0.87
22.00 to 29.99	22	78.00	25.10	2.70	16.05	0.90
30.00	30	107.0	38.90	2.69	15.00	0.80

400 V class series for China version (FRN\_ \_ \_ C2■-4C)

380 V, 50 Hz, rated voltage, base frequency, Fuji standard 6-series

Motor capacity (kW)	Nominal applied motor (kW)	Rated current (A)	No-load current (A)	%R1 (%)	%X1 (%)	Rated slip frequency (Hz)
P02/A16		P03/A17	P06/A20	P07/A21	P08/A22	P12/A26
0.01 to 0.09	0.06	0.21	0.19	13.86	11.81	1.77
0.10 to 0.19	0.10	0.34	0.26	13.25	12.96	1.77
0.20 to 0.39	0.20	0.65	0.48	13.27	14.35	2.33
0.40 to 0.74	0.4	1.21	0.74	10.83	15.83	2.40
0.75 to 1.49	0.75	1.82	1.12	9.23	11.35	2.33
1.50 to 2.19	1.5	3.19	1.43	7.10	12.20	2.00
2.20 to 3.69	2.2	4.72	2.31	7.00	11.85	1.80
3.70 to 5.49	3.7	7.70	3.66	6.26	12.12	1.93
5.50 to 7.49	5.5	11.32	5.08	5.51	14.80	1.40
7.50 to 10.99	7.5	15.00	5.94	4.90	16.01	1.57
11.00 to 14.99	11	21.75	8.36	4.12	16.49	1.07
15.00 to 18.49	15	28.59	9.50	3.55	17.92	1.13
18.50 to 21.99	18.5	35.44	10.45	3.18	18.65	0.87
22.00 to 29.99	22	40.66	11.97	2.96	17.61	0.90
30.00	30	56.15	18.53	2.94	16.42	0.80

A box (■) in the above inverter types replaces S (Basic type) or E (EMC filter built-in type) depending on the enclosure.

200 V class series for Europe version (FRN\_ \_ \_ \_C2■-7E)

230 V, 50 Hz, rated voltage, base frequency, Fuji standard 6-series

Motor capacity (kW)	Nominal applied motor (kW)	Rated current (A)	No-load current (A)	%R1 (%)	%X1 (%)	Rated slip frequency (Hz)
P02/A16		P03/A17	P06/A20	P07/A21	P08/A22	P12/A26
0.01 to 0.09	0.06	0.49	0.46	13.35	11.38	1.77
0.10 to 0.19	0.1	0.73	0.63	12.10	11.83	1.77
0.20 to 0.39	0.2	1.36	1.15	11.47	12.40	2.33
0.40 to 0.74	0.4	2.32	1.79	8.95	13.08	2.40
0.75 to 1.49	0.75	3.60	2.70	7.54	9.27	2.33
1.50 to 2.19	1.5	5.76	3.45	5.38	9.25	2.00
2.20 to 3.69	2.2	8.80	5.58	5.39	9.12	1.80
3.70 to 5.49	3.7	14.27	8.86	4.79	9.28	1.93
5.50 to 7.49	5.5	20.76	12.31	4.18	11.21	1.40
7.50 to 10.99	7.5	26.92	14.38	3.63	11.87	1.57
11.00 to 14.99	11	38.84	20.24	3.04	12.16	1.07
15.00 to 18.49	15	50.14	23.00	2.57	12.98	1.13
18.50 to 21.99	18.5	60.55	25.19	2.28	13.36	0.87
22.00 to 29.99	22	70.40	28.87	2.12	12.60	0.90
30.00	30	97.54	44.74	2.13	11.89	0.80

400 V class series for Europe version (FRN\_ \_ \_ \_C2■-4E)

400 V, 50 Hz, rated voltage, base frequency, Fuji standard 6-series

Motor capacity (kW)	Nominal applied motor (kW)	Rated current (A)	No-load current (A)	%R1 (%)	%X1 (%)	Rated slip frequency (Hz)
P02/A16		P03/A17	P06/A20	P07/A21	P08/A22	P12/A26
0.01 to 0.09	0.06	0.22	0.20	13.79	11.75	1.77
0.10 to 0.19	0.10	0.35	0.27	12.96	12.67	1.77
0.20 to 0.39	0.20	0.65	0.50	12.61	13.63	2.33
0.40 to 0.74	0.4	1.20	0.78	10.20	14.91	2.40
0.75 to 1.49	0.75	1.80	1.18	8.67	10.66	2.33
1.50 to 2.19	1.5	3.10	1.50	6.55	11.26	2.00
2.20 to 3.69	2.2	4.60	2.43	6.48	10.97	1.80
3.70 to 5.49	3.7	7.50	3.85	5.79	11.22	1.93
5.50 to 7.49	5.5	11.00	5.35	5.09	13.66	1.40
7.50 to 10.99	7.5	14.50	6.25	4.50	14.70	1.57
11.00 to 14.99	11	21.00	8.80	3.78	15.12	1.07
15.00 to 18.49	15	27.50	10.00	3.24	16.37	1.13
18.50 to 21.99	18.5	34.00	11.00	2.90	17.00	0.87
22.00 to 29.99	22	39.00	12.60	2.70	16.05	0.90
30.00	30	54.00	19.50	2.69	15.00	0.80

A box (■) in the above inverter types replaces S (Basic type) or E (EMC filter built-in type) depending on the enclosure.

200 V class series, single-phase 100 V class series for USA version  
 (FRN\_ \_ \_ \_C2S-2U, FRN\_ \_ \_ \_C2S-7U, FRN\_ \_ \_ \_C2S-6U)

230 V, 60 Hz, rated voltage, base frequency, Fuji standard 6-series

Motor capacity (kW)	Nominal applied motor (kW)	Rated current (A)	No-load current (A)	%R1 (%)	%X1 (%)	Rated slip frequency (Hz)
P02/A16		P03/A17	P06/A20	P07/A21	P08/A22	P12/A26
0.01 to 0.09	0.06	0.42	0.38	11.45	9.75	1.77
0.10 to 0.19	0.1	0.63	0.53	10.44	10.21	1.77
0.20 to 0.39	0.2	1.20	0.96	10.12	10.94	2.33
0.40 to 0.74	0.4	2.10	1.50	8.10	11.84	2.40
0.75 to 1.49	0.75	3.27	2.25	6.85	8.42	2.33
1.50 to 2.19	1.5	5.44	2.88	5.08	8.73	2.00
2.20 to 3.69	2.2	8.24	4.65	5.05	8.54	1.80
3.70 to 5.49	3.7	13.40	7.38	4.50	8.72	1.93
5.50 to 7.49	5.5	19.61	10.25	3.95	10.59	1.40
7.50 to 10.99	7.5	25.72	11.98	3.47	11.34	1.57
11.00 to 14.99	11	37.20	16.87	2.91	11.65	1.07
15.00 to 18.49	15	48.50	19.17	2.48	12.55	1.13
18.50 to 21.99	18.5	58.93	20.99	2.22	13.00	0.87
22.00 to 29.99	22	68.57	24.05	2.06	12.27	0.90
30.00	30	94.36	37.28	2.06	11.50	0.80

400 V class series for USA version (FRN\_ \_ \_ \_C2S-4U)

460 V, 60 Hz, rated voltage, base frequency, Fuji standard 6-series

Motor capacity (kW)	Nominal applied motor (kW)	Rated current (A)	No-load current (A)	%R1 (%)	%X1 (%)	Rated slip frequency (Hz)
P02/A16		P03/A17	P06/A20	P07/A21	P08/A22	P12/A26
0.01 to 0.09	0.06	0.21	0.19	11.45	9.75	1.77
0.10 to 0.19	0.10	0.32	0.26	10.30	10.07	1.77
0.20 to 0.39	0.20	0.60	0.48	10.12	10.94	2.33
0.40 to 0.74	0.4	1.09	0.75	8.06	11.78	2.40
0.75 to 1.49	0.75	1.64	1.13	6.87	8.45	2.33
1.50 to 2.19	1.5	2.76	1.44	5.07	8.72	2.00
2.20 to 3.69	2.2	4.12	2.33	5.05	8.54	1.80
3.70 to 5.49	3.7	6.71	3.69	4.50	8.73	1.93
5.50 to 7.49	5.5	9.80	5.13	3.94	10.58	1.40
7.50 to 10.99	7.5	12.86	5.99	3.47	11.34	1.57
11.00 to 14.99	11	18.61	8.43	2.91	11.65	1.07
15.00 to 18.49	15	24.25	9.58	2.48	12.55	1.13
18.50 to 21.99	18.5	29.89	10.54	2.22	13.00	0.87
22.00 to 29.99	22	34.29	12.08	2.06	12.27	0.90
30.00	30	47.61	18.69	2.06	11.50	0.80

- When HP rating IM (P99 = 1 or A39 = 1) are selected, the motor parameters are as listed in the following tables. (HP refers to horse power that is used mainly in North America as a unit of motor capacity.)

200 V class series, single-phase 100 V class series for all destinations, 230 V, 60 Hz, rated voltage, base frequency

Motor capacity (HP)	Nominal applied motor (HP)	Rated current (A)	No-load current (A)	%R1 (%)	%X1 (%)	Rated slip frequency (Hz)
P02/A16		P03/A17	P06/A20	P07/A21	P08/A22	P12/A26
0.01 to 0.11	0.10	0.44	0.40	13.79	11.75	2.50
0.12 to 0.24	0.12	0.68	0.55	12.96	12.67	2.50
0.25 to 0.49	0.25	1.40	1.12	11.02	13.84	2.50
0.50 to 0.99	0.5	2.00	1.22	6.15	8.80	2.50
1.00 to 1.99	1	3.00	1.54	3.96	8.86	2.50
2.00 to 2.99	2	5.80	2.80	4.29	7.74	2.50
3.00 to 4.99	3	7.90	3.57	3.15	20.81	1.17
5.00 to 7.49	5	12.60	4.78	3.34	23.57	1.50
7.50 to 9.99	7.5	18.60	6.23	2.65	28.91	1.17
10.00 to 14.99	10	25.30	8.75	2.43	30.78	1.17
15.00 to 19.99	15	37.30	12.70	2.07	29.13	1.00
20.00 to 24.99	20	49.10	9.20	2.09	29.53	1.00
25.00 to 29.99	25	60.00	16.70	1.75	31.49	1.00
30.00 to 39.99	30	72.40	19.80	1.90	32.55	1.00

400 V class series for all destinations, 460 V, 60 Hz, rated voltage, base frequency

Motor capacity (HP)	Nominal applied motor (HP)	Rated current (A)	No-load current (A)	%R (%)	%X (%)	Rated slip frequency (Hz)
P02/A16		P03/A17	P06/A20	P07/A21	P08/A22	P12/A26
0.01 to 0.11	0.10	0.22	0.20	13.79	11.75	2.50
0.12 to 0.24	0.12	0.34	0.27	12.96	12.67	2.50
0.25 to 0.49	0.25	0.70	0.56	11.02	13.84	2.50
0.50 to 0.99	0.5	1.00	0.61	6.15	8.80	2.50
1.00 to 1.99	1	1.50	0.77	3.96	8.86	2.50
2.00 to 2.99	2	2.90	1.40	4.29	7.74	2.50
3.00 to 4.99	3	4.00	1.79	3.15	20.81	1.17
5.00 to 7.49	5	6.30	2.39	3.34	23.57	1.50
7.50 to 9.99	7.5	9.30	3.12	2.65	28.91	1.17
10.00 to 14.99	10	12.70	4.37	2.43	30.78	1.17
15.00 to 19.99	15	18.70	6.36	2.07	29.13	1.00
20.00 to 24.99	20	24.60	4.60	2.09	29.53	1.00
25.00 to 29.99	25	30.00	8.33	1.75	31.49	1.00
30.00 to 39.99	30	36.20	9.88	1.90	32.55	1.00



<b>H04</b>	<b>Auto-reset (Times)</b>
<b>H05</b>	<b>Auto-reset (Reset interval)</b>

H04 and H05 specify the auto-reset function that makes the inverter automatically attempt to reset the tripped state and restart without issuing an alarm (for any faults) even if any protective function subject to reset is activated and the inverter enters the forced-to-stop state (tripped state).

If the protective function works in excess of the times specified by H04, the inverter will issue an alarm (for any faults) and not attempt to auto-reset the tripped state.

Listed below are the recoverable alarm statuses to be retried.

Alarm status	LED monitor displays:	Alarm status	LED monitor displays:
Overcurrent protection	<i>OC 1, OC2 or OC3</i>	Motor overheated	<i>OH4</i>
Overvoltage protection	<i>OU 1, OU2 or OU3</i>	Motor overloaded	<i>OL 1 or OL2</i>
Heat sink overheated	<i>OH 1</i>	Inverter overloaded	<i>OLU</i>
Braking resistor overheated	<i>OBH</i>		

■ Number of reset times (H04)

H04 specifies the number of reset times for the inverter to automatically attempt to escape from the tripped state. When H04 = 0, the auto-reset function will not be activated.

⚠ <b>WARNING</b>
<p>If the "auto-reset" function has been specified, the inverter may automatically restart and run the motor stopped due to a trip fault, depending on the cause of the tripping.</p> <p>Design the machinery so that human body and peripheral equipment safety is ensured even when the auto-resetting succeeds.</p> <p><b>Otherwise an accident could occur.</b></p>

■ Reset interval (H05)

H05 specifies the reset interval time from when the inverter enters the tripped state until it issues the reset command to attempt to auto-reset the state. Refer to the timing scheme diagrams below.

<Operation timing schemes>

- In the figure below, normal operation restarts by the 4th retry.

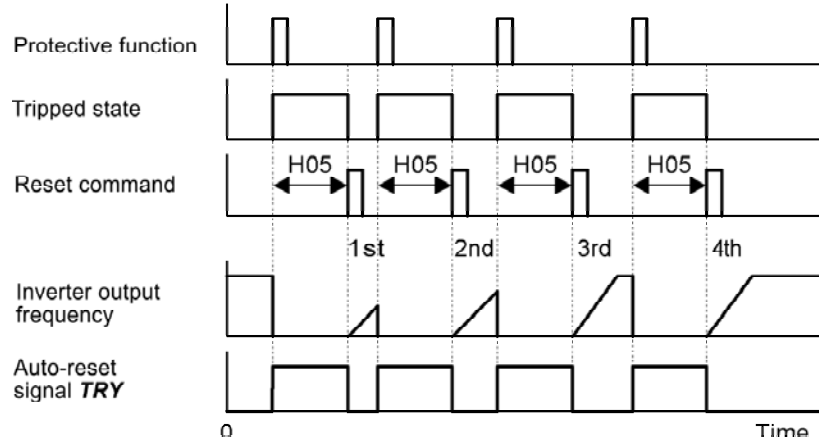

- In the figure below, the inverter fails to restart normal operation within the number of reset times specified by H04 (in this case, 3 times (H04 = 3)), and issues the alarm output (for any alarm) *ALM*.

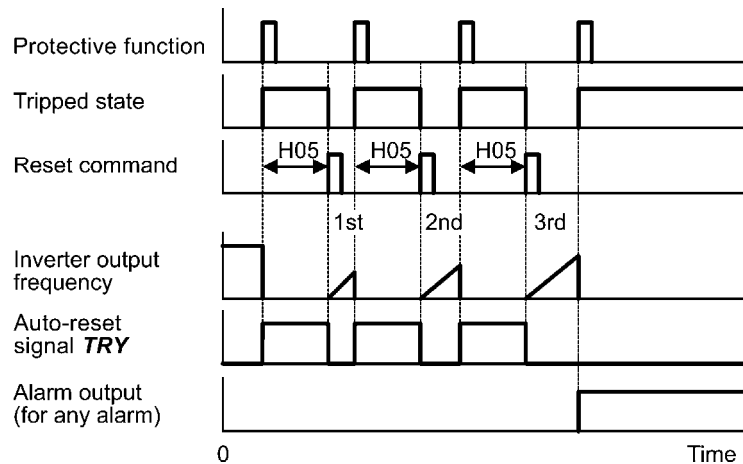

The auto-reset operation can be monitored from the external equipment by assigning the digital output signal *TRY* to any of the programmable output terminals [Y1] and [30A/B/C] with E20 or E27 (data = 26).

<b>H06</b>	<b>Cooling Fan ON/OFF Control</b>
------------	-----------------------------------

To prolong the service life of the cooling fan and reduce fan noise during running, the cooling fan stops when the temperature inside the inverter drops below a certain level while the inverter stops. However, since frequent switching of the cooling fan shortens its service life, the cooling fan is kept running for 10 minutes once it is started.

H06 specifies whether to keep running the cooling fan all the time or to control its ON/OFF.

Data for H06	Cooling fan ON/OFF
0	Disable (Cooling fan always ON)
1	Enable (ON/OFF control effective)

<b>H07</b>	<b>Acceleration/Deceleration Pattern</b>
------------	--

H07 specifies the acceleration and deceleration patterns (patterns to control output frequency).

Data for H07	Accl./Decel. pattern
0	Linear (Default)
1	S-curve (Weak)
2	S-curve (Strong)
3	Curvilinear

**Linear acceleration/deceleration**

The inverter runs the motor with the constant acceleration and deceleration.

**S-curve acceleration/deceleration**

To reduce an impact that acceleration/deceleration would make on the machinery (load), the inverter gradually accelerates or decelerates the motor in both starting and ending zones of acceleration/deceleration. Two types of S-curve acceleration/deceleration rates are available; 5% (weak) and 10% (strong) of the maximum frequency, which are shared by the four inflection points.

The acceleration/deceleration time command determines the duration of acceleration/deceleration in the linear period; hence, the actual acceleration/deceleration time is longer than the reference acceleration/deceleration time.

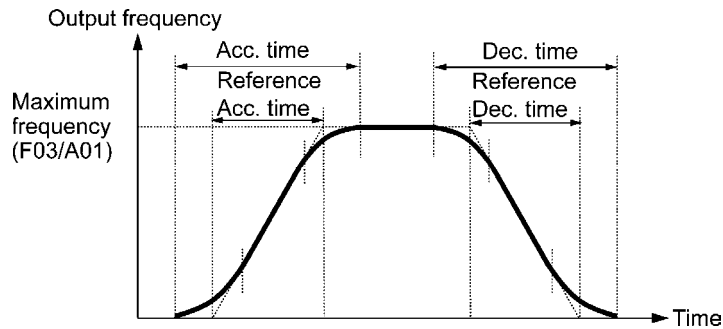

**Acceleration/deceleration time**

<S-curve acceleration/deceleration (weak): when the frequency change is 10% or more of the maximum frequency>

$$\begin{aligned} \text{Acceleration or deceleration time (s)} &= (2 \times 5/100 + 90/100 + 2 \times 5/100) \times (\text{reference acceleration or deceleration time}) \\ &= 1.1 \times (\text{reference acceleration or deceleration time}) \end{aligned}$$

<S-curve acceleration/deceleration (strong): when the frequency change is 20% or more of the maximum frequency>

$$\begin{aligned} \text{Acceleration or deceleration time (s)} &= (2 \times 10/100 + 80/100 + 2 \times 10/100) \times (\text{reference acceleration or deceleration time}) \\ &= 1.2 \times (\text{reference acceleration or deceleration time}) \end{aligned}$$

**Curvilinear acceleration/deceleration**

Acceleration/deceleration is linear below the base frequency (constant torque) but it slows down above the base frequency to maintain a certain level of load factor (constant output).

This acceleration/deceleration pattern allows the motor to accelerate or decelerate with the maximum performance.

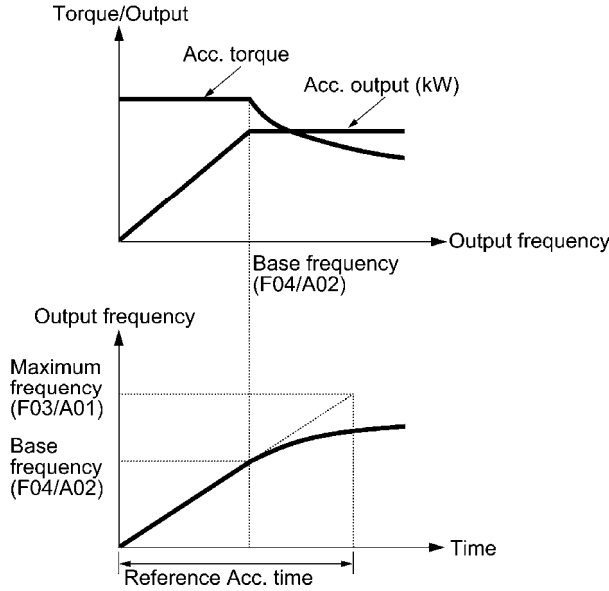

The figures at left show the acceleration characteristics. Similar characteristics apply to the deceleration.

**Note** Choose an appropriate acceleration/deceleration time, taking into account the machinery's torque.

**H08 Rotational Direction Limitation**

H08 inhibits the motor from running in an unexpected rotational direction due to miss-operation of run commands, miss-polarization of frequency commands, or other mistakes.

Data for H08	Function
0	Disable
1	Enable (Reverse rotation inhibited)
2	Enable (Forward rotation inhibited)

<b>H11</b>	<b>Deceleration Mode</b>
------------	--------------------------

H11 specifies the deceleration mode to be applied when a run command is turned OFF.

Data for H11	Function
0	Normal deceleration The inverter decelerates and stops the motor according to deceleration commands specified by H07 (Acceleration/deceleration pattern), F08 (Deceleration time 1), and E11 (Deceleration time 2).
1	Coast-to-stop The inverter immediately shuts down its output, so the motor stops according to the inertia of the motor and machine and their kinetic energy losses.

 **Note** When reducing the reference frequency, the inverter decelerates the motor according to the deceleration commands even if H11 = 1 (Coast-to-stop).

<b>H12</b>	<b>Instantaneous Overcurrent Limiting (Mode selection)</b>
------------	--

H12 specifies whether the inverter invokes the current limit processing or enters the overcurrent trip when its output current exceeds the instantaneous overcurrent limiting level. Under the current limit processing, the inverter immediately turns off its output gate to suppress the further current increase and continues to control the output frequency.

Data for H12	Function
0	Disable An overcurrent trip occurs at the instantaneous overcurrent limiting level.
1	Enable The current limiting operation is effective.

If any problem occurs when the motor torque temporarily drops during current limiting processing, it is necessary to cause an overcurrent trip (H12 = 0) and actuate a mechanical brake at the same time.

 **Note** The similar function is the current limiter specified by F43 and F44. The current limiter (F43, F44) implements the current control by software, so an operation delay occurs. When you have enabled the current limiter (F43, F44), also enable the instantaneous overcurrent limiting with H12 to obtain a quick response current limiting.

Depending on the load, extremely short acceleration time may activate the current limiting to suppress the increase of the inverter output frequency, causing hunting (undesirable oscillation of the system) or activating the inverter overvoltage trip (alarm  $\overline{UL}$ ). When specifying the acceleration time, therefore, you need to take into account machinery characteristics and moment of inertia of the load.

### CAUTION

When the instantaneous overcurrent limiting is enabled, the motor output torque could drop. For driving elevating machinery which could cause a serious problem with a drop of the motor output torque, therefore, disable the instantaneous overcurrent limiting. Note that disabling it will cause an overcurrent trip when a current exceeding the inverter protection level flows, so secure the protective coordination using a mechanical brake.

**An accident could occur.**

H13	Restart Mode after Momentary Power Failure (Restart time) F14 (Restart Mode after Momentary Power Failure, Mode selection)
H14	Restart Mode after Momentary Power Failure (Frequency fall rate) F14
H15	Restart Mode after Momentary Power Failure (Continuous running level) F14

For configuring these function codes (restart time, frequency fall rate, and continuous running level), refer to the description of F14.

H26	Thermistor (Mode selection)
H27	Thermistor (Level)

These function codes specify the PTC (Positive Temperature Coefficient) thermistor embedded in the motor. The thermistor is used to protect the motor from overheating or output an alarm signal.

■ Thermistor (Mode selection) (H26)

H26 selects the operation mode (protection or alarm) for the PTC thermistor as listed below.

Data for H26	Action
0	Disable
1	Enable When the voltage sensed by the PTC thermistor exceeds the detection level, the motor protective function (alarm $\square/44$ ) is triggered so that the inverter stops due to the alarm.
2	When the voltage sensed by the PTC thermistor exceeds the detection level, the inverter issues digital output signal <b>THM</b> and continues to run.

■ Thermistor (Level) (H27)

H27 specifies the detection level (expressed in voltage) for the temperature sensed by the PTC thermistor.

- Data setting range: 0.00 to 5.00 (V)

The temperature at which the overheating protection becomes activated depends on the characteristics of the PTC thermistor. The internal resistance of the thermistor will significantly change at the alarm temperature. The detection level (voltage) is specified based on the change of the internal resistance.

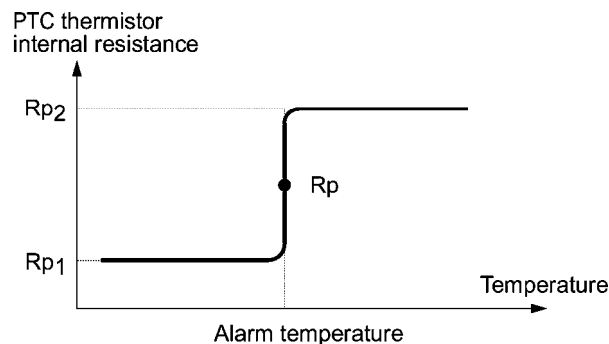

Suppose that the internal resistance of the PTC thermistor at the alarm temperature is  $R_p$ , the detection level (voltage)  $V_{v2}$  is calculated by the expression below. Set the result  $V_{v2}$  to function code H27.

$$V_{c1} = \frac{\frac{250 \cdot R_p}{250 + R_p}}{R_1 + \frac{250 \cdot R_p}{250 + R_p}} \times 10 \text{ (V)}$$

Connect the PTC thermistor as shown below. The voltage obtained by dividing the input voltage on terminal [C1] with a set of internal resistors is compared with the detection level voltage specified by H27.

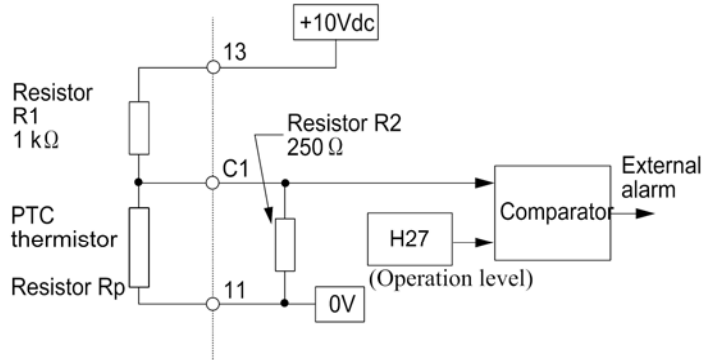

**H30 Communications Link Function (Mode selection)**

Using the RS-485 communications link allows you to issue frequency commands and run commands from a computer or PLC at a remote location, as well as monitoring the inverter running information and the function code data.

H30 specifies the sources of those commands--"inverter itself" and "computers or PLCs via the RS-485 communications link."

Command sources selectable

Command sources	Description
Inverter itself	Command sources except RS-485 communications link Frequency command source: Specified by F01 or C30, or multistep frequency command Run command source: Via the keypad or digital input terminals selected by F02
RS-485 communications link	Via the RJ-45 port

Command sources specified by H30

Data for H30	Frequency command	Run command
0	Inverter itself (F01, C30)	Inverter itself (F02)
1	Via the RS-485 communications link	Inverter itself (F02)
2	Inverter itself (F01, C30)	Via the RS-485 communications link
3	Via the RS-485 communications link	Via the RS-485 communications link

For details, refer to the RS-485 Communication User's Manual (MEH448).

- When the terminal command **LE** ("Enable communications link via RS-485") is assigned to a programmable, digital input terminal, turning **LE** ON enables the settings of H30. When **LE** is OFF, those settings are disabled so that both frequency commands and run commands specified from the inverter itself take control.

<b>H42</b>	<b>Capacitance of DC Link Bus Capacitor</b>
------------	---

H42 displays the measured capacitance of the DC link bus capacitor.

<b>H43</b>	<b>Cumulative Run Time of Cooling Fan</b>
------------	---

H43 displays the cumulative run time of the cooling fan.

<b>H44</b>	<b>Startup Counter of Motor 1</b>
------------	-----------------------------------

H44 displays the startup times of motor 1.

<b>H45</b>	<b>Mock Alarm</b>	<b>H97 (Clear Alarm Data)</b>
------------	-------------------	-------------------------------

H45 causes the inverter to generate a mock alarm in order to check whether external sequences function correctly at the time of machine setup.

Setting the H45 data to "1" displays mock alarm  $\bar{E}rr$  on the LED monitor. It also issues alarm output (for any alarm) **ALM** (if assigned to a digital output terminal by E20 or E27). (Accessing the H45 data requires simultaneous keying of "STOP" key +  $\wedge$  key.) After that, the H45 data automatically reverts to "0," allowing you to reset the alarm.

Just as for data (alarm history and relevant information) of those alarms that could occur in running the inverter, the inverter saves mock alarm data, enabling you to confirm the mock alarm status.

To clear the mock alarm data, use H97. (Accessing the H97 data requires simultaneous keying of "STOP" key +  $\wedge$  key.) H97 data automatically reverts to "0" after clearing the alarm data. For details, refer to the description of H97.

<b>H47</b>	<b>Initial Capacitance of DC Link Bus Capacitor</b>
------------	---

H47 displays the initial value of the capacitance of the DC link bus capacitor.

<b>H48</b>	<b>Cumulative Run Time of Capacitors on Printed Circuit Boards</b>
------------	--

H48 displays the cumulative run time of the capacitors mounted on the printed circuit boards.



H50	<b>Non-linear V/f Pattern 1 (Frequency)</b>	F04 (Base Frequency 1) F05 (Rated Voltage at Base Frequency 1) F06 (Maximum Output Voltage 1)
H51	<b>Non-linear V/f Pattern 1 (Voltage)</b>	F04 to F06
H52	<b>Non-linear V/f Pattern 2 (Frequency)</b>	F04 to F06
H53	<b>Non-linear V/f Pattern 2 (Voltage)</b>	F04 to F06

For details about the setting of the non-linear V/f pattern, refer to the descriptions of F04 to F06.

H54	<b>ACC/DEC Time (Jogging operation)</b>
-----	---

H54 specifies the common acceleration and deceleration time for jogging operation.

- Data setting range: 0.00 to 3600 (s)



For details about the jogging operation (**JOG**), refer to E01 to E03 that assign terminal commands to digital input terminals [X1] to [X3].

H61	<b>UP/DOWN Control (Initial frequency setting)</b>
-----	--

H61 specifies the initial reference frequency to be applied at startup of **UP/DOWN** control that increases or decreases the reference frequency with the **UP/DOWN** terminal command.



For details, refer to function codes E01 to E03 that assign terminal commands to digital input terminals [X1] to [X3].

H63	<b>Low Limiter (Mode selection)</b>	F15 (Frequency Limiter, High) F16 (Frequency Limiter, Low)
-----	-------------------------------------	---

For how to set up this function code data, refer to the descriptions of F15 and F16.

H64	<b>Low Limiter (Lower limiting frequency)</b>
-----	---

H64 specifies the lower limit of frequency to be applied when the current limiter, automatic deceleration (anti-regenerative control), or overload prevention control is activated. Normally, it is not necessary to change this data.

- Data setting range: 0.0 to 60.0 (Hz)

**H69****Automatic Deceleration (Anti-regenerative control) (Mode selection)****H76 (Torque Limiter, Frequency increment limit for braking)**

H69 specifies anti-regenerative control.

In inverters not equipped with a PWM converter or braking resistor, if regenerative energy returned exceeds the inverter's braking capability, an overvoltage trip occurs.

When H69 = 1: The anti-regenerative control is functionally equivalent to that of the original FRENIC-Mini series (FRN□□□C1□-□□). That is, when the DC link bus voltage exceeds the preset voltage limiting level, the inverter lengthens the deceleration time to three times the specified time to decrease the deceleration torque to 1/3. In this way, the inverter reduces the regenerative energy tentatively. This control applies only in deceleration. When the load on the motor results in a braking effect, the control does not have any effect.

When H69 = 2 or 4: The inverter controls the output frequency to keep the braking torque at around 0 N·m in both acceleration/deceleration and constant speed running phases in order to avoid an overvoltage trip.

Since increasing the output frequency too much under anti-regenerative control is dangerous, the inverter has a torque limiter (Frequency increment limit for braking) that can be specified by H76. The torque limiter limits the inverter's output frequency to less than "Reference frequency + H76 setting."

Note that the torque limiter activated restrains the anti-regenerative control, resulting in a trip with an overvoltage alarm in some cases. Increasing the H76 data (0.0 to 400.0 Hz) makes the anti-regenerative control capability high.

In addition, during deceleration triggered by turning the run command OFF, the anti-regenerative control increases the output frequency so that the inverter may not stop the load depending on the load state (huge moment of inertia, for example). To avoid that, H69 provides a choice of cancellation of the anti-regenerative control to apply when three times the specified deceleration time is elapsed, thus decelerating the motor.

Data for H69	Function
0	Disable
1	Enable (Lengthen the deceleration time to three times the specified time under voltage limiting control) (Compatible with the original FRENIC-Mini series (FRN□□□C1□-□□))
2	Enable (Torque limit control: Cancel the anti-regenerative control if the actual deceleration time exceeds three times the specified one.)
4	Enable (Torque limit control: Disable force-to-stop processing.)

 **Note** Enabling the anti-regenerative control may automatically increase the deceleration time.

When a brake resistor is connected, disable the anti-regenerative control.

**H70****Overload Prevention Control**

H70 specifies the decelerating rate of the output frequency to prevent a trip from occurring due to an overload. This control decreases the output frequency of the inverter before the inverter trips due to a heat sink overheat or inverter overload (with an alarm indication of  $\overline{H}$  or  $\overline{L}$ , respectively). It is useful for equipment such as pumps where a decrease in the output frequency leads to a decrease in the load and it is necessary to keep the motor running even when the output frequency drops.

Data for H70	Function
0.00	Decelerate the motor by deceleration time 1 (F08) or 2 (E11)
0.01 to 100.00	Decelerate the motor by deceleration rate from 0.01 to 100.00 (Hz/s)
999	Disable overload prevention control

 **Note** In equipment where a decrease in the output frequency does not lead to a decrease in the load, the overload prevention control is of no use and should not be enabled.

<b>H71</b>	<b>Deceleration Characteristics</b>
------------	-------------------------------------

Setting the H71 data to "1" (ON) enables forced brake control. If regenerative energy produced during deceleration of the motor and returned to the inverter exceeds the inverter's braking capability, an overvoltage trip will occur. The forced brake control increases the motor energy loss during deceleration, increasing the deceleration torque.



**Note** This function is aimed at controlling the torque during deceleration; it has no effect if there is braking load.

Enabling the automatic deceleration (anti-regenerative control, H69 = 2 or 4) disables the deceleration characteristics specified by H71.

When replacing the original FRENIC-Mini series (FRN□□□C1□-□□) with the upgraded one (FRN□□□C2□-□□), note the following.

The original FRENIC-Mini series (FRN□□□C1□-□□) does not support H71, but H71 may be set to "1." On the upgraded one, however, it is not necessary to set H71 to "1."

<b>H76</b>	<b>Automatic Deceleration (Frequency increment limit for braking)</b> <b>H69 (Automatic Deceleration, Mode selection)</b>
------------	--

For details about the function of H76, refer to the description of H69.

<b>H78</b> <b>H94</b>	<b>Maintenance Interval</b> <b>Cumulative Motor Run Time 1</b>
--------------------------	---

H78 (Maintenance interval) specifies the maintenance interval in units of ten hours.

The maximum setting is  $9999 \times 10$  hours.

- Data setting range: 0 (Disable); 1 to 9999 (in units of ten hours)

■ Maintenance timer -- **MNT** (E20 and E27, data = 84)

When the cumulative motor run time 1 (H94) reaches the time specified by H78 (Maintenance interval), the inverter outputs the maintenance timer signal **MNT** (if assigned to any digital terminal with any of E20 and E27) to remind the user of the need of the maintenance of the mechanical system.

■ Cumulative motor run time 1 (H94)

Operating the keypad can display the cumulative run time of motor 1. This feature is useful for management and maintenance of the mechanical system. H94 allows you to set the cumulative run time of the motor to the desired value, which enables setting an arbitrary initial data to determine a parts or inverter replacement timing. Specifying "0" clears the cumulative run time of the motor.

< Biannual maintenance >

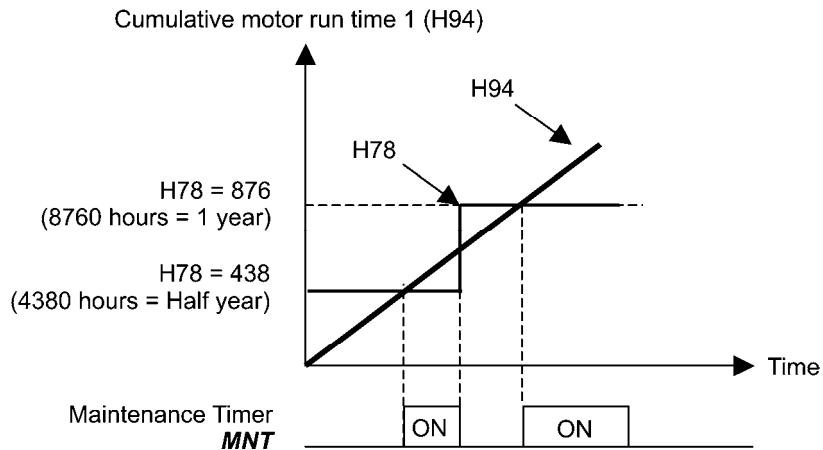

**Note** After the current setting has expired, set a value for the next maintenance in H78 and press the **FUNC DATA** key so that the output signal is reset and counting restarts. This function is exclusively applies to the 1st motor.

**Note** Check the cumulative motor run time with **S-23** on Menu #5 "Maintenance Information" of the keypad. Similarly, check the time remaining before the next maintenance with **S-31**.

<b>H79</b>	<b>Preset Startup Count for Maintenance (M1)</b>	<b>H44 (Startup Counter for Motor 1)</b>
------------	--	--

H79 specifies the number of inverter startup times to determine the next maintenance timing, e.g., for replacement of a belt.

Set the H79 and H44 data in hexadecimal. The maximum setting count is 65,535 (FFFF in hexadecimal.)

- Data setting range: 0000 (Disable); 0001 to FFFF (Hexadecimal)

■ Maintenance timer -- **MNT** (E20 and E27, data = 84)

When the count of the startup counter for motor 1 (H44) reaches the number specified by H79 (Preset startup count for maintenance (M1)), the inverter outputs the maintenance timer signal **MNT** (if assigned to any digital terminal with any to E20 and E27) to remind the user of the need of the maintenance of the mechanical system.

< Maintenance every 1,000 times of startups >

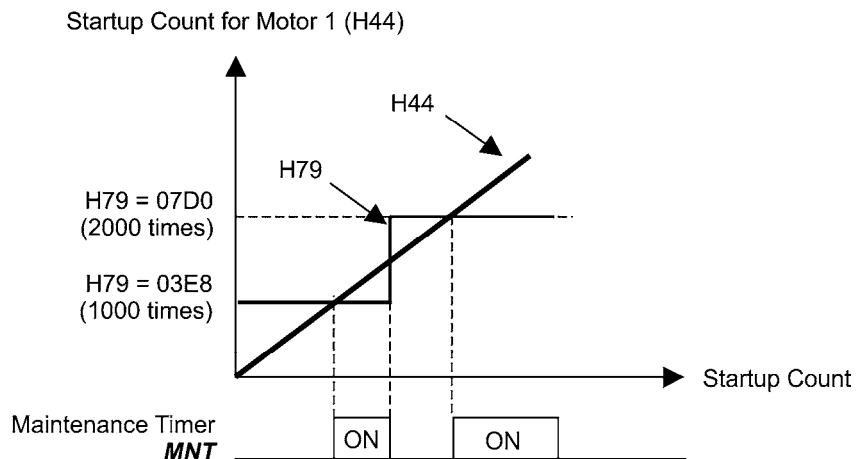

**Note** After the current setting has expired, set a value for the next maintenance in H79 and press the  key so that the output signal is reset and counting restarts. This function is exclusively applies to the 1st motor.

Check the startup times remaining before the next maintenance with  on Menu #5 "Maintenance Information" of the keypad.

<b>H80</b>	<b>Output Current Fluctuation Damping Gain for Motor 1 A41 (Output Current Fluctuation Damping Gain for Motor 2)</b>
------------	--

The inverter output current driving the motor may fluctuate due to the motor characteristics and/or backlash in the machinery (load). Modifying the H80 data adjusts the controls in order to suppress such fluctuation. However, as incorrect setting of this gain may cause larger current fluctuation, do not modify the default setting unless it is necessary.

- Data setting range: 0.00 to 0.40

<b>H89</b>	<b>Electronic Thermal Overload Protection for Motor (Data retention)</b>
------------	--

H89 specifies whether to retain the cumulative data of the electronic thermal overload protection for motor when the power is shut down.

Data for H89	Function
0	Clear the cumulative data of the electronic thermal overload protection for motor the moment the power is turned ON after the power is shut down.
1	Retain the cumulative data of the electronic thermal overload protection for motor when the power is shut down.

<b>H91</b>	<b>PID Feedback Wire Break Detection (Terminal [C1])</b>
------------	--

Using terminal [C1] (Current input) for PID feedback signals enables wire break detection and alarm () issuance. H91 specifies whether or not to enable the wire break detection and the duration of detection. (The inverter judges an input current less than 2 mA on terminal [C1] as a wire break.)

Expanding the input range of terminal [C1] to "0 to 20 mA DC" with function code C40 disables the PID feedback wire break detection.

- Data setting range: 0.0 (Disable wire break detection)  
0.1 to 60.0 (s) (Detect wire break after the specified duration and issue  alarm)

H92, H93	<b>Continuity of Running (P and I)</b> <b>F14 (Restart Mode after Momentary Power Failure)</b>
----------	---

For details, refer to the description of F14.

H94	<b>Cumulative Run Time of Motor 1</b> <b>A51 (Cumulative Run Time of Motor 2)</b>
-----	---

For details, refer to the description of H79.

H95	<b>DC Braking (Braking response mode)</b>  <div style="text-align: right;"> <b>F20 to F22 (DC Braking 1,  Braking starting frequency, Braking level, and Braking time)</b>  <b>A09 to A11 (DC Braking 2,  Braking starting frequency, Braking level, and Braking time)</b> </div>
-----	---

For setting of DC braking, refer to the descriptions of F20 to F22.

H96	<b>STOP Key Priority/Start Check Function</b>
-----	---

H96 specifies a functional combination of "STOP key priority" and "Start check function" as listed below.

Data for H96	STOP key priority	Start check function
0	Disable	Disable
1	Enable	Disable
2	Disable	Enable
3	Enable	Enable

■ STOP key priority

Even when a run command is entered from a digital input terminal (F02 = 1) or via the RS-485 communications link (link operation), pressing the  key forces the inverter to decelerate and stop the motor. After that,  $\bar{E}-\bar{E}$  appears on the LED monitor.

■ Start check function

For safety, this function checks whether a run command has been turned ON or not in each of the following situations. If it has been turned ON, the inverter does not start up with alarm code  $\bar{E}-\bar{E}$  displayed on the LED monitor.

- When the power to the inverter is turned ON.
- When the  key is pressed to release the alarm status or when the digital input terminal command **RST** ("Reset alarm") is turned ON.
- When the run command source is switched by the digital input terminal command **LE** ("Enable communications link via RS-485").

<b>H97</b>	<b>Clear Alarm Data</b>	<b>H45 (Mock Alarm)</b>
------------	-------------------------	-------------------------

H97 clears all alarm data (alarm history and relevant information) of alarms that have occurred in running of the inverter and mock alarms that have been caused by H45 at the time of machine setup, both of which are saved in the inverter memory.

Setting the H97 data to "1" clears the saved alarm data. (Accessing the H97 data requires simultaneous keying of "STOP" key + "↵" key.) After that, the H97 data automatically reverts to "0."

<b>H98</b>	<b>Protection/Maintenance Function (Mode selection)</b>	
------------	---	--

H98 specifies whether to enable or disable (a) automatic lowering of carrier frequency, (b) input phase loss protection, (c) output phase loss protection, and (d) judgment on the life of the DC link bus capacitor, as well as specifying the judgment threshold on the life of the DC link bus capacitor, in a combination of Bit 0 to Bit 4.

#### Automatic lowering of carrier frequency (Bit 0)

This function should be used for important machinery that requires keeping the inverter running.

Even if a heat sink overheat or overload occurs due to excessive load, abnormal ambient temperature, or cooling system failure, enabling this function lowers the carrier frequency to avoid tripping (L111 or L111). Note that enabling this function results in increased motor noise.

**Note** When the output circuit filter OFL-□□□-2 or -4 is connected, be sure to set this bit to "0" to disable the automatic carrier frequency lowering function.

#### Input phase loss protection (L117) (Bit 1)

Upon detection of an excessive stress inflicted on the apparatus connected to the main circuit due to phase loss or line-to-line voltage unbalance in the three-phase power supplied to the inverter, this feature stops the inverter and displays an alarm L117.

**Note** In configurations where only a light load is driven or a DC reactor is connected, phase loss or line-to-line voltage unbalance may not be detected because of the relatively small stress on the apparatus connected to the main circuit.

#### Output phase loss protection (L11L) (Bit 2)

Upon detection of phase loss in the output while the inverter is running, this feature stops the inverter and displays an alarm L11L. Where a magnetic contactor is installed in the inverter output circuit, if the magnetic contactor goes OFF during operation, all the phases will be lost. In such a case, this protection feature does not work.

#### Judgment threshold on the life of DC link bus capacitor (Bit 3)

Bit 3 is used to select the threshold for judging the life of the DC link bus capacitor between factory default setting and your own choice.

**Note** Before specifying the threshold of your own choice, measure and confirm the reference level in advance.

### Judgment on the life of DC link bus capacitor (Bit 4)

Whether the DC link bus capacitor has reached its life is determined by measuring the length of time for discharging after power off. The discharging time is determined by the capacitance of the DC link bus capacitor and the load inside the inverter. Therefore, if the load inside the inverter fluctuates significantly, the discharging time cannot be accurately measured, and as a result, it may be mistakenly determined that the life has been reached. To avoid such an error, you can disable the judgment on the life of the DC link bus capacitor.

Since load may vary significantly in the following cases, disable the judgment on the life during operation. Either conduct the measurement with the judgment enabled under appropriate conditions during periodical maintenance or conduct the measurement under the operating conditions matching the actual ones.

- A remote keypad (option) is used.
- Another inverter or equipment such as a PWM converter is connected to the terminals of the DC link bus.

To set data of H98, assign functions to each bit (total 5 bits) and set it in decimal format. The table below lists functions assigned to each bit.

Bit number	Bit 4	Bit 3	Bit 2	Bit 1	Bit 0
Function	Judge the life of DC link bus capacitor	Select life judgment threshold of DC link bus capacitor	Detect output phase loss	Detect input phase loss	Lower the carrier frequency automatically
Data = 0	Disable	Use the factory default *1	Disable *1	Disable	Disable
Data = 1	Enable *1	Use the user setting	Enable	Enable *1	Enable *1
Example of decimal expression (19)	Enable (1)	Use the factory default (0)	Disable (0)	Enable (1)	Enable (1)

\*1 Factory default

### Conversion table (Decimal to/from binary)

Decimal	Binary					Decimal	Binary				
	Bit 4	Bit 3	Bit 2	Bit 1	Bit 0		Bit 4	Bit 3	Bit 2	Bit 1	Bit 0
0	0	0	0	0	0	16	1	0	0	0	0
1	0	0	0	0	1	17	1	0	0	0	1
2	0	0	0	1	0	18	1	0	0	1	0
3	0	0	0	1	1	19	1	0	0	1	1
4	0	0	1	0	0	20	1	0	1	0	0
5	0	0	1	0	1	21	1	0	1	0	1
6	0	0	1	1	0	22	1	0	1	1	0
7	0	0	1	1	1	23	1	0	1	1	1
8	0	1	0	0	0	24	1	1	0	0	0
9	0	1	0	0	1	25	1	1	0	0	1
10	0	1	0	1	0	26	1	1	0	1	0
11	0	1	0	1	1	27	1	1	0	1	1
12	0	1	1	0	0	28	1	1	1	0	0
13	0	1	1	0	1	29	1	1	1	0	1
14	0	1	1	1	0	30	1	1	1	1	0
15	0	1	1	1	1	31	1	1	1	1	1



### 9.2.6 A codes (Motor 2 parameters)

A01	Maximum Frequency 2	F03 (Maximum Frequency 1)
A02	Base Frequency 2	F04 (Base Frequency 1)
A03	Rated Voltage at Base Frequency 2	F05 (Rated Voltage at Base Frequency 1)
A04	Maximum Output Voltage 2	F06 (Maximum Output Voltage 1)
A05	Torque Boost 2	F09 (Torque Boost 1)
A06	Electronic Thermal Overload Protection for Motor 2 (Select motor characteristics)	F10 (Electronic Thermal Overload Protection for Motor 1, Select motor characteristics)
A07	Electronic Thermal Overload Protection for Motor 2 (Overload detection level)	F11 (Electronic Thermal Overload Protection for Motor 1, Overload detection level)
A08	Electronic Thermal Overload Protection for Motor 2 (Thermal time constant)	F12 (Electronic Thermal Overload Protection for Motor 1, Thermal time constant)
A09	DC Braking 2 (Braking starting frequency)	F20 (DC Braking 1, Braking starting frequency)
A10	DC Braking 2 (Braking level)	F21 (DC Braking 1, Braking level)
A11	DC Braking 2 (Braking time)	F22 (DC Braking 1, Braking time)
A12	Starting Frequency 2	F23 (Starting Frequency 1)
A13	Load Selection/Auto Torque Boost/Auto Energy Saving Operation 2 F37 (Load Selection/Auto Torque Boost/Auto Energy Saving Operation 1)	
A14	Control Mode Selection 2	F42 (Control Mode Selection 1)
A16	Motor 2 (Rated capacity)	P02 (Motor 1, Rated capacity)
A17	Motor 2 (Rated current)	P03 (Motor 1, Rated current)
A18	Motor 2 (Auto-tuning)	P04 (Motor 1, Auto-tuning)
A20	Motor 2 (No-load current)	P06 (Motor 1, No-load current)
A21	Motor 2 (%R1)	P07 (Motor 1, %R1)
A22	Motor 2 (%X)	P08 (Motor 1, %X)
A23	Motor 2 (Slip compensation gain for driving)	P09 (Motor 1, Slip compensation gain for driving)

<b>A24</b>	<b>Motor 2 (Slip compensation response time)</b> P10 (Motor 1, Slip compensation response time)
<b>A25</b>	<b>Motor 2 (Slip compensation gain for braking)</b> P11 (Motor 1, Slip compensation gain for braking)
<b>A26</b>	<b>Motor 2 (Rated slip frequency)</b> P12 (Motor 1, Rated slip frequency)
<b>A39</b>	<b>Motor 2 Selection</b> P99 (Motor 1 Selection)
<b>A41</b>	<b>Output Current Fluctuation Damping Gain for Motor 2</b> H80 (Output Current Fluctuation Damping Gain for Motor 1)
<b>A51</b>	<b>Cumulative Run Time of Motor 2</b> H94 (Cumulative Run Time of Motor 1)
<b>A52</b>	<b>Startup Counter of Motor 2</b> H44 (Startup Counter of Motor 1)

These function codes listed above apply to the 2nd motor. For details about the 1st and 2nd motors, refer to the descriptions of E1 to E03 (data = 12), "Select motor 2 / motor 1--*M2/M1*."

### 9.2.7 J codes (Application functions)

J01	PID Control (Mode selection)
J02	PID Control (Remote command SV)
J03	PID Control P (Gain)
J04	PID Control I (Integral time)
J05	PID Control D (Differential time)
J06	PID Control (Feedback filter)

Under PID control, the inverter detects the state of a control target object with a sensor or similar device and compares it with the commanded value (e.g. temperature control command). If there is any deviation between them, PID control operates to minimize it. That is, it is a closed loop feedback system that matches controlled variable (feedback amount). PID control expands the application area of the inverter to process control (e.g., flow control, pressure control, and temperature control.)

If PID control is enabled (J01 = 1 or 2), the frequency control of the inverter is switched from the drive frequency command generator block to the PID command one.

PID process control block diagram

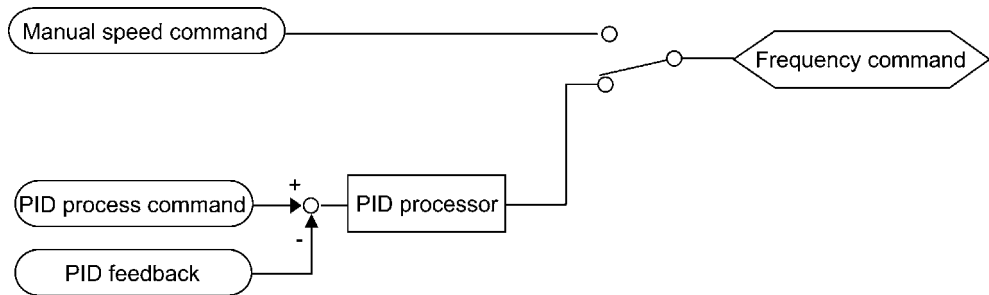

■ Mode Selection (J01)

J01 selects the PID control mode.

Data for J01	Function
0	Disable
1	Enable (Process control, normal operation)
2	Enable (Process control, inverse operation)

- Using J01 enables switching between normal and inverse operations against the PID process control output, so you can specify an increase/decrease of the motor rotating speed to the difference (error component) between the commanded (input) and feedback amounts, making it possible to apply the inverter to air conditioners. The *IVS* terminal command can also switch operation between normal and inverse.

 For details of switching between normal and inverse operations, refer to the description of the *IVS* ("Switch normal/inverse operation") assigned by any of E01 to E03 (data = 21).

---

### Selecting Feedback Terminals

For feedback control, determine the connection terminal according to the type of the sensor output.

- If the sensor is a current output type, use the current input terminal [C1] of the inverter.
- If the sensor is a voltage output type, use the voltage input terminal [12] of the inverter.



For details, refer to the descriptions of E61 and E62.

### Application example: Process control

The operating range for PID process control is internally controlled as 0% through 100%. For the given feedback input, determine the operating range to be controlled by means of gain adjustment.

(Example) When the output level of the external sensor is within the range of 1 to 5 V:

- Use terminal [12] which is designed for voltage input.
- Set the gain (C32 for analog input adjustment) at 200% in order to make the maximum value (5 V) of the external sensor's output correspond to 100%. Note that the input specification for terminal [12] is 0 to 10 V corresponding to 0 to 100%; thus, a gain factor of 200% ( $= 10 \text{ V} \div 5 \times 100$ ) should be specified. Note also that any bias setting does not apply to feedback control.

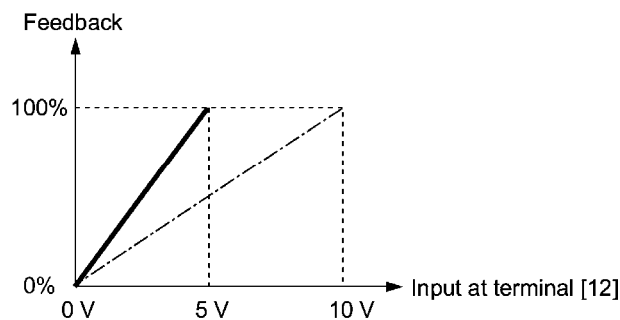

■ Remote command **SV** (J02)

J02 sets the source that specifies the command value (**SV**) under PID control.

Data for J02	Function
0	Keypad Using the $\wedge$ / $\vee$ keys on the keypad in conjunction with PID display coefficients (specified by E40 and E41), you can specify 0 to 100% of the PID command in an easy-to-understand converted command format. For details of operation, refer to Chapter 3 "OPERATION USING THE KEYPAD."
1	PID process command 1 (Built-in potentiometer, Terminals [12] and [C1]) In addition to J02 setting, it is necessary to select PID command 1 for analog input (specified by any of E60, E61 and E62, function code data = 3). For details, refer to the descriptions of E60 to E62.
3	Terminal command <b>UP/DOWN</b> Using the <b>UP</b> or <b>DOWN</b> command in conjunction with PID display coefficients (specified by E40 and E41), you can specify 0 to 100% of the PID command in an easy-to-understand converted command format. In addition to J02 setting, it is necessary to assign <b>UP</b> and <b>DOWN</b> commands to any of terminals [X1] through [X3] with E01 through E03 (function code data = 17, 18). For details of UP/DOWN operation, refer to the assignment of the <b>UP</b> and <b>DOWN</b> commands.
4	Command via communications link Use function code S13 that specifies the communications-linked PID command. The transmission data of 20000 (decimal) is equal to 100% (maximum frequency) of the PID command. For details of the communications format, refer to the RS-485 Communication User's Manual (MEH448).



- Other than the remote command selection by J02, the multistep frequency (C08 = 4) specified by **SS4** and **SS8** terminal commands can also be selected as a preset value for the PID command.

Calculate the setting data of the PID command using the expression below.

$$\text{PID command data (\%)} = \frac{\text{Preset multistep frequency} \div \text{(Maximum frequency)}}{\times 100}$$

**Data Setting Range of PID Command (Only applicable to an analog input)**

To select an analog input as a PID command, define the setting range of the PID command. As with frequency setting, it is possible to arbitrary map the relationship between the command and the analog input value by adjusting the gain and bias.



For details, refer to the descriptions of C32, C34, C37, C39, C51 and C52.

(Example) Mapping the range of 1 through 5 V at terminal [12] to 0 through 100%

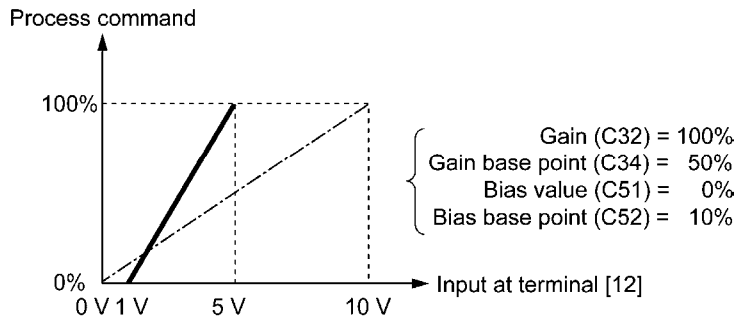

---

## PID Display Coefficient and Monitoring

To monitor PID commands and their feedback, define the display coefficient for converting the contents into easy-to-understand physical quantities such as temperature.

 Refer to the descriptions of E40 and E41 for details on display coefficients, and to E43 for details on monitoring.

### ■ Gain (J03)

J03 specifies the gain for the PID processor.

- Data setting range: 0.000 to 30.000 (multiple)

### P (Proportional) action

An operation in which the MV (manipulated value: output frequency) is proportional to the deviation is called P action, which outputs the MV in proportion to deviation. However, the P action alone cannot eliminate deviation.

Gain is data that determines the system response level against the deviation in P action. An increase in gain speeds up response, but an excessive gain may oscillate the inverter output. A decrease in gain delays response, but it stabilizes the inverter output.

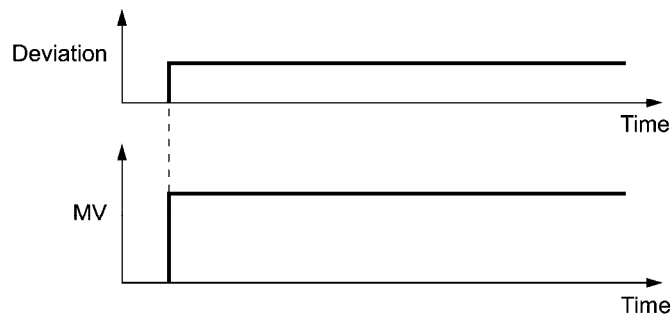

### ■ Integral time (J04)

J04 specifies the integral time for the PID processor.

- Data setting range: 0.0 to 3600.0 (s)  
0.0 means that the integral component is ineffective.

### I (Integral) action

An operation that the change rate of an MV (manipulated value: output frequency) is proportional to the integral value of deviation is called I action, which outputs the MV that integrates the deviation. Therefore, I action is effective in bringing the feedback amount close to the commanded value. For the system whose deviation rapidly changes, however, this action cannot make it react quickly.

The effectiveness of I action is expressed by integral time as parameter, that is J04 data. The longer the integral time, the slower the response. The reaction to the external disturbance also becomes slow. The shorter the integral time, the faster the response. Setting too short integral time, however, makes the inverter output tend to oscillate against the external disturbance.

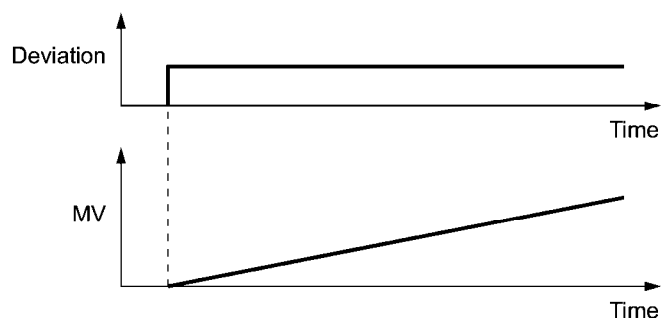

### ■ Differential time (J05)

J05 specifies the differential time for the PID processor.

- Data setting range: 0.00 to 600.00 (s)  
0.00 means that the differential component is ineffective.

### D (Differential) action

An operation in which the MV (manipulated value: output frequency) is proportional to the differential value of the deviation is called D action, which outputs the MV that differentiates the deviation. D action makes the inverter quickly react to a rapid change of deviation.

The effectiveness of D action is expressed by differential time as a parameter, which is J05 data. Setting a long differential time will quickly suppress oscillation caused by P action when a deviation occurs. Too long differential time makes the inverter output oscillation more. Setting short differential time weakens the suppression effect when the deviation occurs.

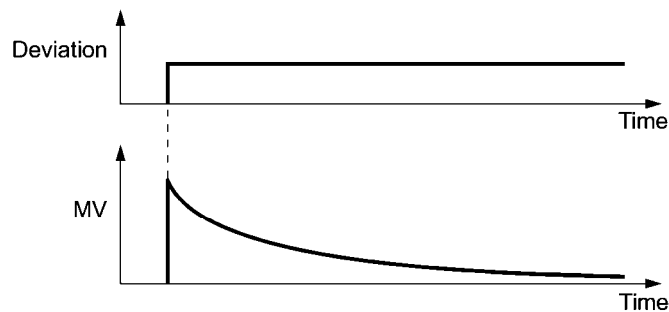

The combined uses of P, I, and D actions are described below.

#### (1) PI control

PI control, which is a combination of P and I actions, is generally used to minimize the remaining deviation caused by P action. PI control acts to always minimize the deviation even if a commanded value changes or external disturbance steadily occurs. However, the longer the integral time, the slower the system response to quick-changed control.

P action can be used alone for loads with very large part of integral components.

#### (2) PD control

Under PD control, the moment that a deviation occurs, the control rapidly generates greater MV (manipulated value) than that generated by D action alone, to suppress the deviation increase. When the deviation becomes small, the behavior of P action becomes small.

A load including the integral component in the controlled system may oscillate due to the action of the integral component if P action alone is applied. In such a case, use PD control to reduce the oscillation caused by P action, for keeping the system stable. That is, PD control is applied to a system that does not contain any damping actions in its process.

#### (3) PID control

PID control is implemented by combining P action with the deviation suppression of I action and the oscillation suppression of D action. PID control features minimal control deviation, high precision and high stability.

In particular, PID control is effective to a system that has a long response time to the occurrence of deviation.

Follow the procedure below to set data to PID control function codes.

It is highly recommended that you adjust the PID control value while monitoring the system response waveform with an oscilloscope or equivalent. Repeat the following procedure to determine the optimal solution for each system.

- Increase the data of J03 (PID control P (Gain)) within the range where the feedback signal does not oscillate.
- Decrease the data of J04 (PID control I (Integral time)) within the range where the feedback signal does not oscillate.
- Increase the data of J05 (PID control D (Differential time)) within the range where the feedback signal does not oscillate.

Refining the system response waveforms is shown below.

1) Suppressing overshoot

Increase the data of J04 (Integral time) and decrease that of J05 (Differential time.)

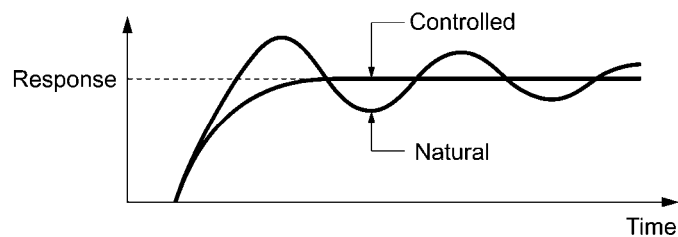

2) Quick stabilizing (moderate overshoot allowable)

Decrease the data of J03 (Gain) and increase that of J05 (Differential time).

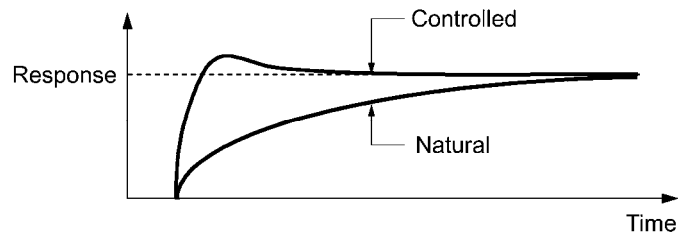

3) Suppressing oscillation whose period is longer than the integral time specified by J04

Increase the data of J04 (Integral time).

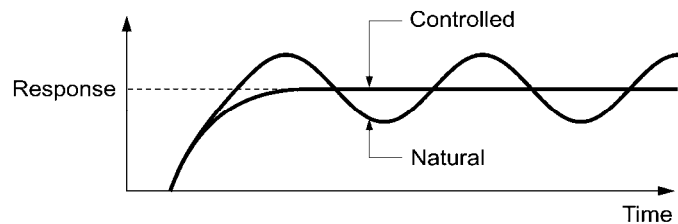

4) Suppressing oscillation whose period is approximately the same as the time specified by J05 (Differential time)

Decrease the data of J05 (Differential time).

Decrease the data of J03 (Gain), if the oscillation cannot be suppressed even if the differential time is set at 0 sec.

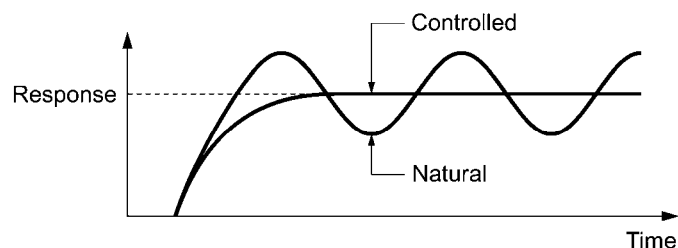



■ Feedback filter (J06)

J06 specifies the time constant of the filter for feedback signals under PID control.

- Data setting range: 0.0 to 900.0 (s)
- This setting is used to stabilize the PID control loop. Setting too long a time constant makes the system response slow.

J15	PID Control (Operation level for slow flowrate stop)
J16	PID Control (Elapsed time from slow flowrate stop)
J17	PID Control (Initiation frequency)
J23	PID Control (Initiation deviation level for slow flowrate stop)
J24	PID Control (Start latency time for slow flowrate stop)

The slow flowrate stop function can be used when the pump constant pressure control is performed under PID control.

If the discharge pressure increases so that the reference frequency (output of the PID processor) drops below the operation level (J15) and remains at the low level for the elapsed time (J16), the inverter decreases to a stop. However, PID control itself continues to operate.

Assigning the **PID-STP** signal to any of the digital output terminals with any of function codes E20 and E27 (data = 44) enables the inverter to output the **PID-STP** signal on that terminal upon detection of a slow flowrate stop.

When both of the following conditions are met, the inverter restarts.

- (1) The discharge pressure decreases so that the reference frequency (output of the PID processor) increases above the initiation frequency (J17) and the start latency time (J24) elapses.
- (2) The deviation between SV (commanded value) and PV (feedback amount) exceeds the initiation deviation level (J23) and the start latency time (J24) elapses.

Function code	Name	Data setting range
J15	Operation level	0.0 (Disable slow flowrate stop), 1.0 to 400.0 Hz
J16	Elapsed time	0 to 3600 s
J17	Initiation frequency	0.0 to 400.0 Hz
J23	Initiation deviation level	0.0 to 100.0%
J24	Start latency time	0 to 3600 s

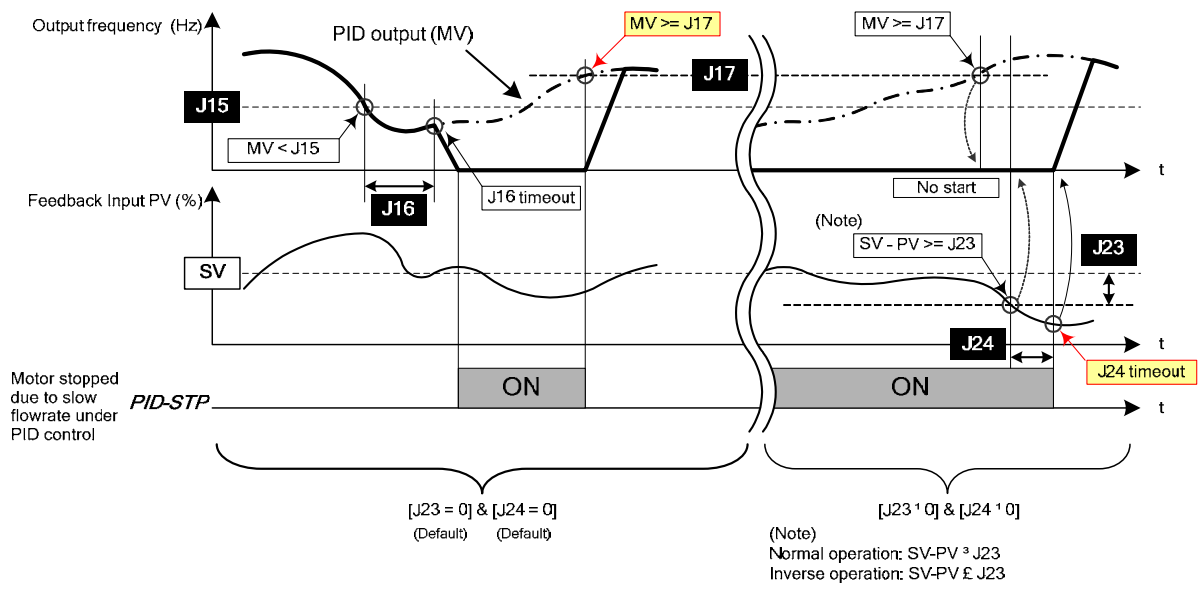
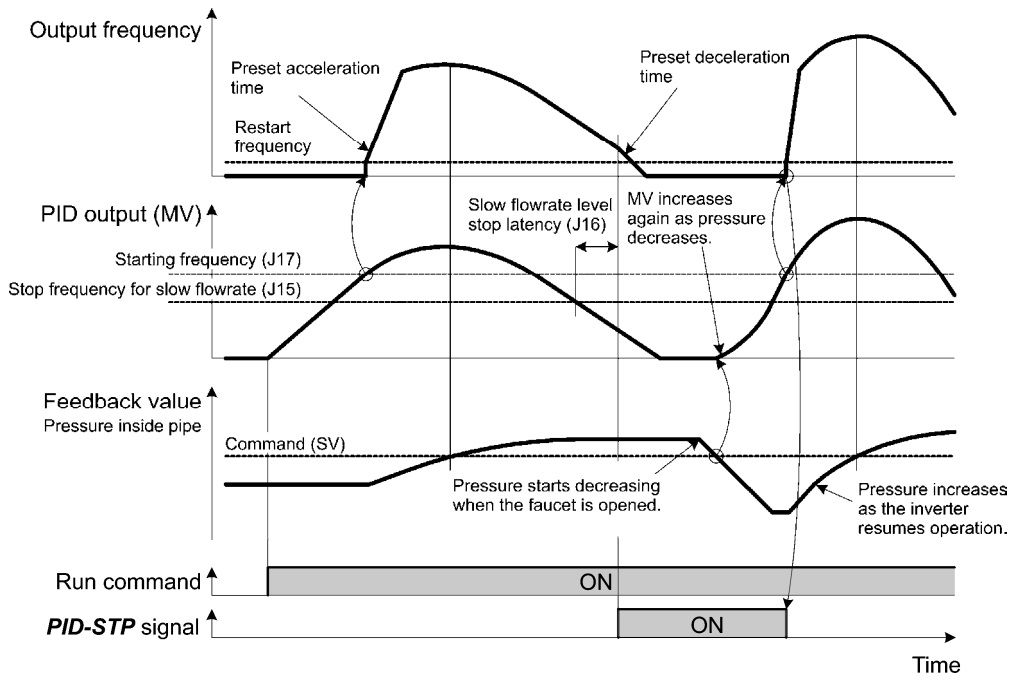

J68	Braking Signal (Brake-OFF current)
J69	Braking Signal (Brake-OFF frequency)
J70	Braking Signal (Brake-OFF timer)
J71	Braking Signal (Brake-ON frequency)
J72	Braking Signal (Brake-ON timer)

These function codes define braking conditions for turning the terminal command **BRKS** on or off to release or activate the brake of hoisting/elevating machines.

#### Releasing the brake

If the inverter judges that the motor generates torque by checking that the output current or output frequency exceeds the specified level (J68/J69) and stays above the level for the period specified by J70, then it turns the **BRKS** ON to release the brake.

Function code	Name	Data setting range
J68	Brake-OFF current	0 to 200%: Set it assuming the inverter rated current as 100%. For the single-phase 100 V class series, see note below.
J69	Brake-OFF frequency	0.0 to 25.0 Hz
J70	Brake-OFF timer	0.0 to 5.0 s

 Note For the single-phase 100 V class series, J68 (Brake-OFF current) should be calculated based on the reference current as shown below.

Inverter type FRN_ _ _C2S-6U	0001	0002	0003	0005
Nominal applied motor (HP)	1/8	1/4	1/2	1
Reference current (A)	0.8	1.5	3.0	5.0

### Activating the brake

If the inverter judges that the motor speed is low enough to assure the motor life by checking that the run command is OFF and the output frequency is lower than the level specified by J71 for the period specified by J72, then it turns the **BRKS** OFF to activate the brake.

Function code	Name	Data setting range
J71	Brake-ON frequency	0.0 to 25.0 Hz
J72	Brake-ON timer	0.0 to 5.0 s

- Note**
- The braking signal control is only applicable to the 1st motor. If the motor switching function selects the 2nd motor, the braking signal remains ON.
  - If the inverter is shut down due to an occurrence of alarms or by the terminal command **BX** ("Coast to a stop"), the brake signal is immediately turned ON.

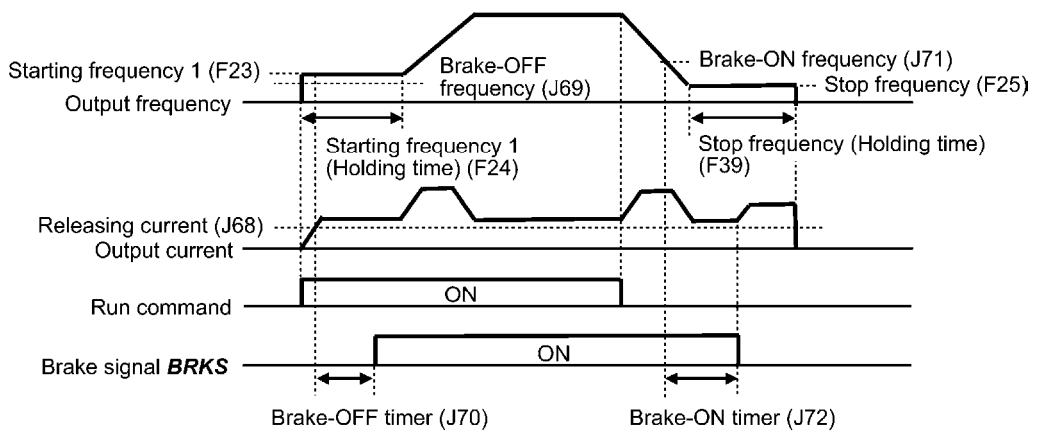

## 9.2.8 y codes (Link functions)

y01 to y10

### RS-485 Communication

#### (1) Remote keypad (option)

The remote keypad allows you to run and monitor the inverter.

Those keypads can be used independent of the y code setting.

#### (2) FRENIC Loader

Connecting your PC running FRENIC Loader to the inverter via the RS-485 communications links (port 1), you can monitor the inverter's running status information, edit function codes, and test-run the inverter.



For the setting of y codes, refer to function codes y01 to y10. For details, refer to the FRENIC Loader Instruction Manual.

#### (3) Host equipment

The inverter can be managed and monitored by connecting the host equipment such as a PC and PLC to the inverter. Modbus RTU\* and Fuji general-purpose inverter protocol are available for communications protocols.

\*Modbus RTU is a protocol established by Modicon, Inc.



For details, refer to the RS-485 Communication User's Manual (MEH448).

#### ■ Station address (y01)

y01 specifies the station address for the RS-485 communications link. The table below lists the protocols and the station address setting ranges.

Protocol	Station address	Broadcast address
Modbus RTU protocol	1 to 247	0
FRENIC Loader protocol	1 to 255	None
FUJI general-purpose inverter protocol	1 to 31	99

- If any wrong address beyond the above range is specified, no response is returned since the inverter will be unable to receive any enquiries except the broadcast message.
- To use FRENIC Loader, set the station address that matches the connected PC.

■ Communications error processing (y02)

y02 specifies the error processing to be performed if an RS-485 communications error occurs. RS-485 communications errors include logical errors (e.g., address error, parity error, framing error), transmission protocol error, and physical errors (e.g., no-response error specified by y08). The inverter can recognize such an error only when it is configured with a run or frequency command sourced through the RS-485 communications link and it is running. If not, the inverter does not recognize any error occurrence.

Data for y02	Function
0	Immediately trip, displaying an RS-485 communications error ( $\mathcal{E}r\mathcal{E}$ for y02). (The inverter stops with alarm issue.)
1	Run during the period specified by the error processing timer (y03), display an RS-485 communications error ( $\mathcal{E}r\mathcal{E}$ for y02), and then stop operation. (The inverter stops with alarm issue.)
2	Retry communication during the period specified by the error processing timer (y03). If a communications link is recovered, continue operation. Otherwise, display an RS-485 communications error ( $\mathcal{E}r\mathcal{E}$ for y02) and stop operation. (The inverter stops with alarm issue.)
3	Continue to run even when a communications error occurs.



For details, refer to the RS-485 Communication User's Manual (MEH448).

■ Timer (y03)

y03 or y13 specifies an error processing timer.

When the specified timer count has elapsed due to no response from the other end when a query has been issued, the inverter interprets it as an error occurrence. See the "No-response error detection time (y08)" given later.

- Data setting range: 0.0 to 60.0 (s)

■ Baud rate (y04)

y04 or y14 specifies the transmission speed for RS-485 communication.

For FRENIC Loader (via the RS-485 communications link), specify the transmission speed that matches the connected computer.

Data for y04	Transmission speed (bps)
0	2400
1	4800
2	9600
3	19200
4	38400

■ Data length (y05)

y05 or y15 specifies the character length for RS-485 communication.

For FRENIC Loader (via the RS-485 communications link), no setting is required since Loader automatically sets 8 bits. (The same applies to the Modbus RTU protocol.)

Data for y05	Data length
0	8 bits
1	7 bits

### ■ Parity check (y06)

y06 or y16 specifies the property of the parity bit.

For FRENIC Loader, no setting is required since Loader automatically sets the even parity.

Data for y06	Parity
0	None (2 stop bits for Modbus RTU)
1	Even parity (1 stop bit for Modbus RTU)
2	Odd parity (1 stop bit for Modbus RTU)
3	None (1 stop bit for Modbus RTU)

### ■ Stop bits (y07)

y07 or y17 specifies the number of stop bits.

For FRENIC Loader, no setting is required since Loader automatically sets 1 bit.

For the Modbus RTU protocol, no setting is required since the stop bits are automatically determined associated with the property of parity bits.

Data for y07	Stop bit(s)
0	2 bits
1	1 bit

### ■ No-response error detection time (y08)

y08 or y18 specifies the timeout period for receiving a response from the host equipment (such as a computer or PLC) in RS-485 communication, in order to detect network breaks. This applies to the machinery that accesses the host equipment at the predetermined intervals.

If the response timeout occurs, the inverter starts communications error processing.

For communications error processing, refer to y02.

Data for y08	No-response error detection
0	No detection
1 to 60	1 to 60 s (detection time)

■ Response interval (y09)

y09 or y19 specifies the latency time after the end of receiving a query sent from the host equipment (such as a PC or PLC) until the start of sending the response. This enables the inverter to control the response timing to match the host equipment that is slow in processing.

- Data setting range: 0.00 to 1.00 (s)

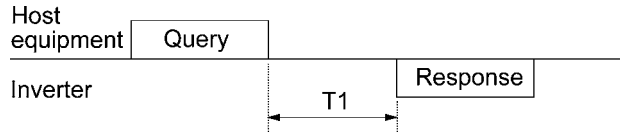

$$T1 = \text{Response interval} + \alpha$$

where  $\alpha$  is the processing time inside the inverter.  $\alpha$  may vary depending on the processing status and the command processed in the inverter.

 For details, refer to the RS-485 Communication User's Manual (MEH448).



When configuring the inverter with FRENIC Loader via the RS-485 communications link, pay sufficient attention to the performance and configuration of the PC and protocol converter such as USB-RS-485 converter. Some protocol converters monitor the communications status and switch between sending and receiving of transmission data with a timer.

■ Protocol selection (y10)

y10 specifies the communications protocol for the standard RS-485 port.

For FRENIC Loader (via the RS-485 communications link), only y10 can be used for protocol selection. Set the y10 data to "1."

Data for y10	Protocol
0	Modbus RTU protocol
1	FRENIC Loader protocol
2	Fuji general-purpose inverter protocol



**y97****Communication Data Storage Selection**

A nonvolatile storage in the inverter has a limited number of rewritable times (100,000 to 1,000,000 times). Saving data into the storage so many times unnecessarily will no longer allow the storage to save data, causing memory errors.

For frequent data writing via the communications link, therefore, a temporary storage is provided instead of the nonvolatile storage. To use the temporary storage, set the y97 data at "1." Using the temporary storage reduces the number of data writing times into the nonvolatile storage, preventing memory errors.

Setting the y97 data at "2" saves all data written in the temporary storage into the nonvolatile one.

Changing the y97 data requires simultaneous keying of  and  keys.

Data for y97	Function
0	Save into nonvolatile storage (Rewritable times limited)
1	Write into temporary storage (Rewritable times unlimited)
2	Save all data from temporary storage to nonvolatile one (After saving data, the data automatically returns to "1.")

**y99****Loader Link Function (Mode selection)**

This is a link switching function for FRENIC Loader. Rewriting the data of y99 to enable RS-485 communications from Loader helps Loader send the inverter the frequency and/or run commands. Since the data to be set in the function code of the inverter is automatically set by Loader, no keypad operation is required.

When Loader is selected as the source of run commands, if the PC runs out of control and cannot be stopped by a stop command sent from Loader, set the y99 data to "0" from the keypad. The setting "0" in y99 means that the run and frequency command source specified by H30 takes place instead of FRENIC Loader.

Note that the y99 data cannot be saved in the inverter. When the power is turned off, the y99 data is lost and reset to "0."

Data for y99	Function	
	Frequency command	Run command
0	Follow H30 data	Follow H30 data
1	Via RS-485 communications link (FRENIC Loader, S01 and S05)	Follow H30 data
2	Follow H30 data	Via RS-485 communications link (FRENIC Loader, S06)
3	Via RS-485 communications link (FRENIC Loader, S01 and S05)	Via RS-485 communications link (FRENIC Loader, S06)

## 9.3 Notes in Driving PMSM

When driving a permanent magnet synchronous motor (PMSM), observe the following notes. Items not covered in this section are the same as for induction motor (IM) drive.

Item	Specifications
Drive by commercial power	A PMSM cannot be driven by commercial power. Be sure to use an inverter. <b>A failure could occur.</b>
Wiring	Be sure to match inverter's output terminals (U, V and W) with motor's input terminals (U, V and W).
Control mode	When F42 = 11 (V/f control for PMSM drive) At the start of driving the motor, the inverter flows current equivalent to 80% of the motor rated current (P03) to pull in the magnetic pole position for synchronization. After that, the inverter accelerates the motor to the reference frequency. No magnetic pole position detection function is provided. No auto search for an idling PMSM and restart function are provided. Depending upon the magnetic pole position, the motor may run in the reverse direction slightly at the start of running.
Speed control range	The speed control range is from 10% to 100% of the base frequency (F04). Set the reference frequency to 10% or more of the F04 data.
Starting torque	70% or more at 10% of the base frequency.
Motor constants	The following motor parameters are used, so consult the motor manufacturer and configure the correct values. No tuning function is provided. F04: Base frequency (Hz) F05: Rated voltage at base frequency (V) (When F05 = 0, the inverter acts as 200/400V setting.) P03: Motor rated current (A) P60: Armature resistance ( $\Omega$ ) P61: d-axis inductance (mH) P62: q-axis inductance (mH) P63: Induced voltage (V) If any of P60, P62 and P63 is set to "0.00," the inverter does not start. Be sure to set correct values. The factory defaults of P60 to P63 are "0.00." If motor parameters are not correct, the inverter cannot run normally. Set P90 to the value less than the demagnetizing current. <b>A failure could occur.</b>
Carrier frequency	The carrier frequency (F26) should be 2 to 16 kHz. Running a PMSM at 0.75 or 1 kHz may result in a failure due to demagnetization. The automatic carrier frequency lowering function at the time of inverter overheat does not work. <b>A failure could occur.</b>
2nd motor	A PMSM cannot be driven as the 2nd motor.
V/f pattern	Linear V/f pattern only. The load selection value (F37) will be ignored.
Auto energy saving	When driving a PMSM, the high-efficiency control is always ON.
Instantaneous overcurrent limiter	This does not work for a PMSM. The H12 setting will be ignored. Even if H12 = 1, an overcurrent trip occurs due to an overcurrent incident.

Item	Specifications
Restart mode after momentary power failure	When the F14 data is set to either 4 or 5, the inverter restarts with pull-in by current.
Automatic deceleration (anti-regenerative control),	When H69 = 1, the automatic deceleration is performed only on inverters compatible with the original FRENIC-Mini series (FRN□□□C1□-□□). When H69 = 2 or 4, no automatic deceleration is performed.
Brake signal	Not available for a PMSM. It is always OFF.
Others	Be sure to consult the motor manufacturers before actual operation. <b>A failure could occur.</b>



# Appendices

## Contents

App. A	Advantageous Use of Inverters (Notes on electrical noise) .....	A-1
A.1	Effect of inverters on other devices .....	A-1
A.2	Noise .....	A-2
A.3	Noise prevention .....	A-4
App. B	Japanese Guideline for Suppressing Harmonics by Customers Receiving High Voltage or Special High Voltage .....	A-12
B.1	Application to general-purpose inverters .....	A-12
B.2	Compliance to the harmonic suppression for customers receiving high voltage or special high voltage .....	A-13
App. C	Effect on Insulation of General-purpose Motors Driven with 400 V Class Inverters .....	A-17
C.1	Generating mechanism of surge voltages .....	A-17
C.2	Effect of surge voltages .....	A-18
C.3	Countermeasures against surge voltages .....	A-18
C.4	Regarding existing equipment .....	A-19
App. D	Inverter Generating Loss .....	A-20
App. E	Conversion from SI Units .....	A-21
App. F	Allowable Current of Insulated Wires .....	A-23
App. G	Replacement Information .....	A-25
G.1	Compatibility and differences between FRENIC-Mini series FRN□□□□C1□-□□ and FRN□□□□C2□-□□ .....	A-25
G.2	External dimensions comparison tables .....	A-26
G.3	Terminal arrangements and symbols .....	A-29
G.4	Function codes .....	A-31



## App. A Advantageous Use of Inverters (Notes on electrical noise)

- Disclaimer: This document provides you with a summary of the Technical Document of the Japan Electrical Manufacturers' Association (JEMA) (April 1994). It is intended to apply to the domestic market only. It is only for reference for the foreign market. -

### A.1 Effect of inverters on other devices

Inverters have been and are rapidly expanding its application fields. This paper describes the effect that inverters have on electronic devices already installed or on devices installed in the same system as inverters, as well as introducing noise prevention measures. (Refer to Section A.3 [3], "Noise prevention examples" for details.)

#### [ 1 ] Effect on AM radios

Phenomenon If an inverter operates, AM radios may pick up noise radiated from the inverter. (An inverter has almost no effect on FM radios or television sets.)

Probable cause Radios may receive noise radiated from the inverter.

Measures Inserting a noise filter on the power supply side of the inverter is effective.

#### [ 2 ] Effect on telephones

Phenomenon If an inverter operates, nearby telephones may pick up noise radiated from the inverter in conversation so that it may be difficult to hear.

Probable cause A high-frequency leakage current radiated from the inverter and motors enters shielded telephone cables, causing noise.

Measures It is effective to commonly connect the grounding terminals of the motors and return the common grounding line to the grounding terminal of the inverter.

#### [ 3 ] Effect on proximity limit switches

Phenomenon If an inverter operates, proximity limit switches (capacitance-type) may malfunction.

Probable cause The capacitance-type proximity limit switches may provide inferior noise immunity.

Measures It is effective to connect a filter to the input terminals of the inverter or change the power supply treatment of the proximity limit switches. The proximity limit switches can be replaced with superior noise immunity types such as magnetic types.

#### [ 4 ] Effect on pressure sensors

Phenomenon If an inverter operates, pressure sensors may malfunction.

Probable cause Noise may penetrate through a grounding wire into the signal line.

Measures It is effective to install a noise filter on the power supply side of the inverter or to change the wiring.

#### [ 5 ] Effect on position detectors (pulse generators PGs or pulse encoders)

Phenomenon If an inverter operates, pulse encoders may produce erroneous pulses that shift the stop position of a machine.

Probable cause Erroneous pulses are liable to occur when the signal lines of the PG and power lines are bundled together.

Measure The influence of induction noise and radiation noise can be reduced by separating the PG signal lines and power lines. Providing noise filters at the input and output terminals is also an effective measure.

## A.2 Noise

This section gives a summary of noises generated in inverters and their effects on devices subject to noise.

### [ 1 ] Inverter noise

Figure A.1 shows an outline of the inverter configuration. The inverter converts AC to DC (rectification) in a converter unit, and converts DC to AC (inversion) with 3-phase variable voltage and variable frequency. The conversion (inversion) is performed by PWM implemented by switching six transistors (IGBT: Insulated Gate Bipolar Transistor, etc), and is used for variable speed motor control.

Switching noise is generated by high-speed on/off switching of the six transistors. Noise current ( $i$ ) is emitted and at each high-speed on/off switching, the noise current flows through stray capacitance ( $C$ ) of the inverter, cable and motor to the ground. The amount of the noise current is expressed as follows:

$$i = C \cdot dv/dt$$

It is related to the stray capacitance ( $C$ ) and  $dv/dt$  (switching speed of the transistors). Further, this noise current is related to the carrier frequency since the noise current flows each time the transistors are switched on or off.

In addition to the main power inverter, the DC-to-DC switching power regulator (DC-DC converter), which is the power source for the control electronics of the inverter, may be a noise source in the same principles as stated above.

The frequency band of this noise is less than approximately 30 to 40 MHz. Therefore, the noise will affect devices such as AM radios using low frequency band, but will not virtually affect FM radios and television sets using higher frequency than this frequency band.

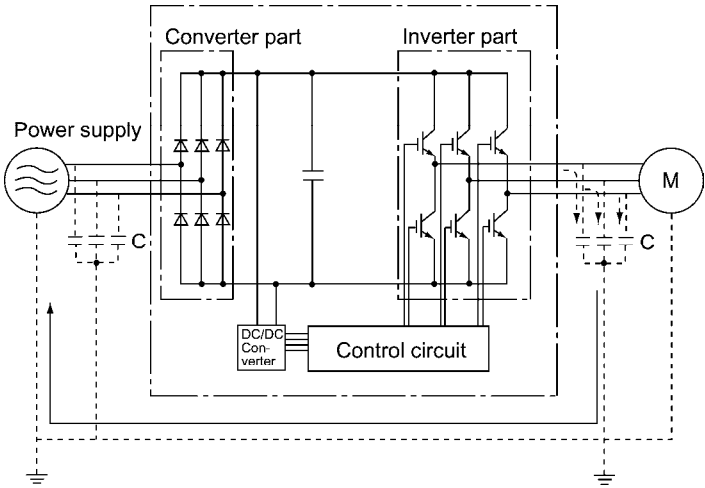

Figure A.1 Outline of Inverter Configuration



[ 2 ] Types of noise

Noise generated in an inverter is propagated through the main circuit wiring to the power supply and the motor so as to affect a wide range of applications from the power supply transformer to the motor. The various propagation routes are shown in Figure A.2. According to those routes, noises are roughly classified into three types--conduction noise, induction noise, and radiation noise.

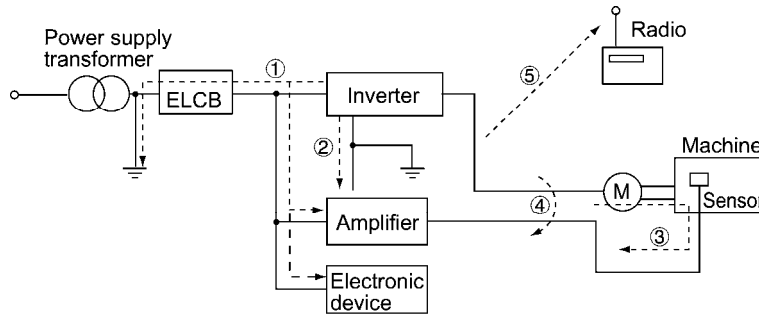

Figure A.2 Noise Propagation Routes

(1) Conduction noise

Noise generated in an inverter may propagate through the conductor and power supply so as to affect peripheral devices of the inverter (Figure A.3). This noise is called "conduction noise." Some conduction noises will propagate through the main circuit ①. If the ground wires are connected to a common ground, conduction noise will propagate through route ②. As shown in route ③, some conduction noises will propagate through signal lines or shielded wires.

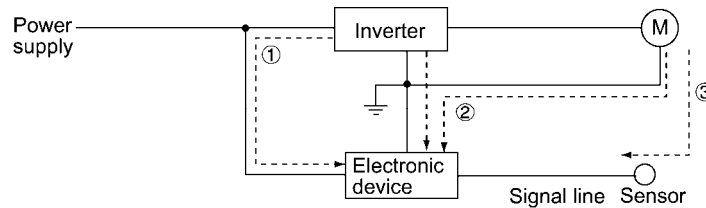

Figure A.3 Conduction Noise

(2) Induction noise

When wires or signal lines of peripheral devices are brought close to the wires on the input and output sides of the inverter through which noise current is flowing, noise will be induced into those wires and signal lines of the devices by electromagnetic induction (Figure A.4) or electrostatic induction (Figure A.5). This is called "induction noise" ④.

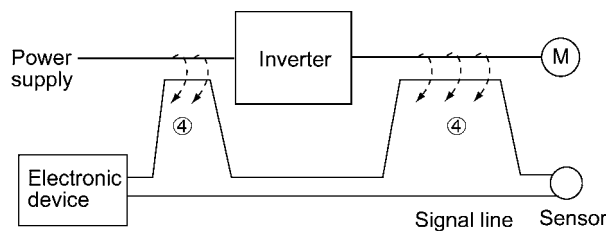

Figure A.4 Electromagnetic Noise

App.

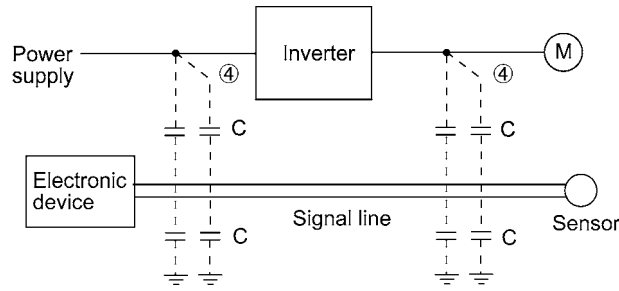

Figure A.5 Electrostatic Noise

### (3) Radiation noise

Noise generated in an inverter may be radiated through the air from wires (that act as antennas) at the input and output sides of the inverter. This noise is called "radiation noise" ⑤ as shown below. Not only wires but motor frames or control system panels containing inverters may also act as antennas.

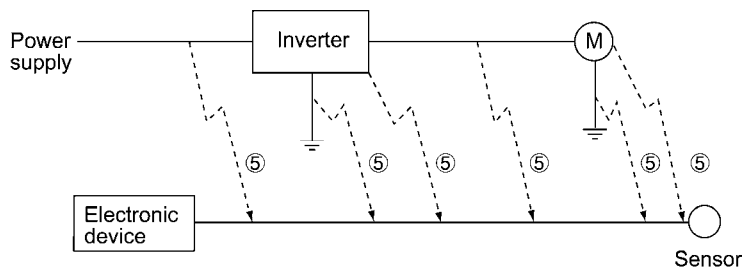

Figure A.6 Radiation Noise

## A.3 Noise prevention

The more noise prevention is strengthened, the more effective. However, with the use of appropriate measures, noise problems may be resolved easily. It is necessary to implement economical noise prevention according to the noise level and the equipment conditions.

### [ 1 ] Noise prevention prior to installation

Before inserting an inverter in your control panel or installing an inverter panel, you need to consider noise prevention. Once noise problems occur, it will cost additional materials and time for solving them.

Noise prevention prior to installation includes:

- 1) Separating the wiring of main circuits and control circuits
- 2) Putting main circuit wiring into a metal pipe (conduit pipe)
- 3) Using shielded wires or twist shielded wires for control circuits.
- 4) Implementing appropriate grounding work and grounding wiring.

These noise prevention measures can avoid most noise problems.

[ 2 ] Implementation of noise prevention measures

There are two types of noise prevention measures--one for noise propagation routes and the other for noise receiving sides (that are affected by noise).

The basic measures for lessening the effect of noise at the receiving side include:

Separating the main circuit wiring from the control circuit wiring, avoiding noise effect.

The basic measures for lessening the effect of noise at the generating side include:

- 1) Inserting a noise filter that reduces the noise level.
- 2) Applying a metal conduit pipe or metal control panel that will confine noise, and
- 3) Applying an insulated transformer for the power supply that cuts off the noise propagation route.

Table A.1 lists the noise prevention measures, their goals, and propagation routes.

Table A.1 Noise Prevention Measures

Noise prevention method		Goal of noise prevention measures				Conduction route		
		Make it more difficult to receive noise	Cutoff noise conduction	Confine noise	Reduce noise level	Conduction noise	Induction noise	Radiation noise
Wiring and installation	Separate main circuit from control circuit	Y					Y	
	Minimize wiring distance	Y			Y		Y	Y
	Avoid parallel and bundled wiring	Y					Y	
	Use appropriate grounding	Y			Y	Y	Y	Y
	Use shielded wire and twisted shielded wire	Y					Y	Y
	Use shielded cable in main circuit			Y				Y
	Use metal conduit pipe			Y			Y	Y
Control panel	Appropriate arrangement of devices in panel	Y					Y	Y
	Metal control panel			Y			Y	Y
Anti-noise device	Line filter	Y			Y	Y		Y
	Insulation transformer		Y			Y		Y
Measures at noise receiving sides	Use a passive capacitor for control circuit	Y					Y	Y
	Use ferrite core for control circuit	Y			Y		Y	Y
	Line filter	Y		Y		Y		
Others	Separate power supply systems	Y	Y			Y		
	Lower the carrier frequency				Y	Y	Y	Y

Y: Effective, Blank: Not effective

App.

What follows is noise prevention measures for the inverter drive configuration.

### (1) Wiring and grounding

As shown in Figure A.7, separate the main circuit wiring from control circuit wiring as far as possible regardless of being located inside or outside the system control panel containing an inverter. Use shielded wires and twisted shielded wires that will block out extraneous noises, and minimize the wiring distance. Also avoid bundled wiring of the main circuit and control circuit or parallel wiring.

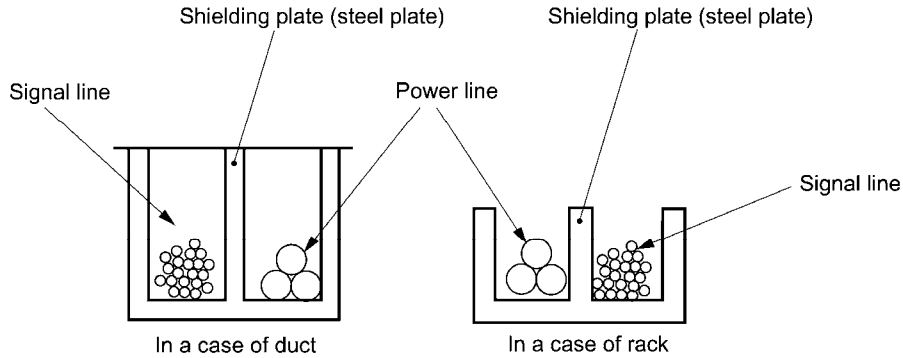

Figure A.7 Separate Wiring

For the main circuit wiring, use a metal conduit pipe and connect its wires to the ground to prevent noise propagation (refer to Figure A.8).

The shield (braided wire) of a shielded wire should be securely connected to the base (common) side of the signal line at only one point to avoid the loop formation resulting from a multi-point connection (refer to Figure A.9).

The grounding is effective not only to reduce the risk of electrical shocks due to leakage current, but also to block noise penetration and radiation. Corresponding to the main circuit voltage, the grounding work should be No. 3 grounding work (300 VAC or less) and special No. 3 grounding work (300 to 600 VAC). Each ground wire is to be provided with its own ground or separately wired to a grounding point.

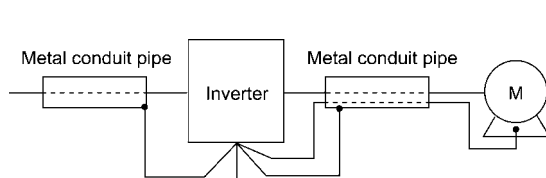

Figure A.8 Grounding of Metal Conduit Pipe

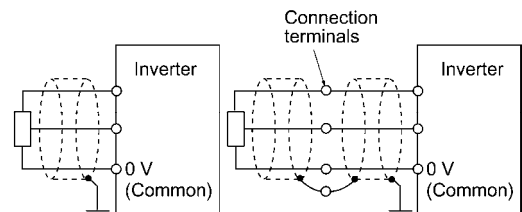

Figure A.9 Treatment of Braided Wire of Shielded Wire

### (2) Panel

The system control panel containing an inverter is generally made of metal, which can shield noise radiated from the inverter itself.

When installing other electronic devices such as a programmable logic controller in the same control panel, be careful with the layout of each device. If necessary, arrange shield plates between the inverter and peripheral devices.

### (3) Anti-noise devices

To reduce the noise propagated through the electrical circuits and the noise radiated from the main circuit wiring to the air, a line filter and power supply transformer should be used (refer to Figure A.10).

Line filters are available in these types--the simplified type such as a capacitive filter to be connected in parallel to the power supply line and an inductive filter to be connected in series to the power supply line and the orthodox type such as an LC filter to meet radio noise regulations. Use them according to the targeted effect for reducing noise.

Power supply transformers include common insulated transformers, shielded transformers, and noise-cutting transformers. These transformers have different effectiveness in blocking noise propagation.

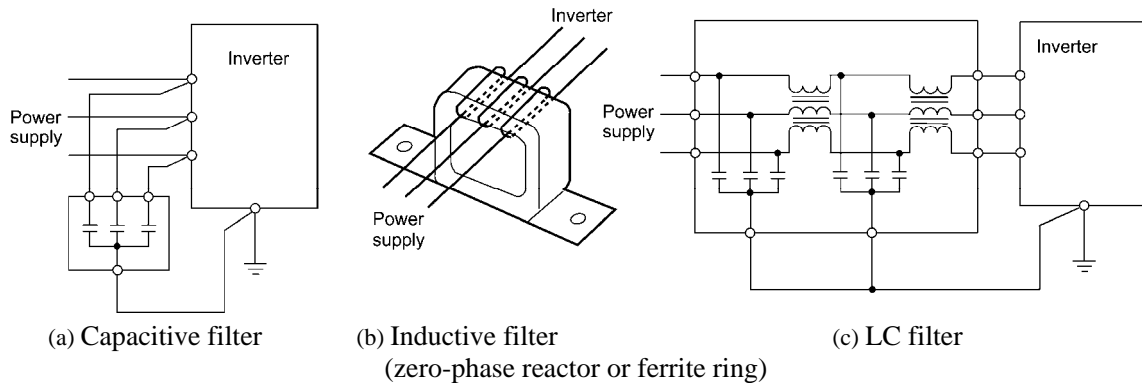

Figure A.10 Various Filters and their Connection

### (4) Noise prevention measures at the receiving side

It is important to strengthen the noise immunity of those electronic devices installed in the same control panel as the inverter or located near an inverter. Line filters and shielded or twisted shielded wires are used to block the penetration of noise in the signal lines of these devices. The following treatments are also implemented.

- 1) Lower the circuit impedance by connecting capacitors or resistors to the input and output terminals of the signal circuit in parallel.
- 2) Increase the circuit impedance for noise by inserting choke coils in series in the signal circuit or passing signal lines through ferrite core beads. It is also effective to widen the signal base lines (0 V line) or grounding lines.

### (5) Other

The level of generating/propagating noise will change with the carrier frequency of the inverter. The higher the carrier frequency, the higher the noise level.

In an inverter whose carrier frequency can be changed, lowering the carrier frequency can reduce the generation of electrical noise and result in a good balance with the audible noise of the motor under driving conditions.

[ 3 ] Noise prevention examples

Table A.2 lists examples of the measures to prevent noise generated by a running inverter.

Table A.2 Examples of Noise Prevention Measures

No.	Target device	Phenomena	Noise prevention measures	
				Notes
1	AM radio	<p>When operating an inverter, noise enters into an AM radio broadcast (500 to 1500 kHz).</p>  <p>&lt;Possible cause&gt; The AM radio may receive noise radiated from wires at the power supply and output sides of the inverter.</p>	<ol style="list-style-type: none"> <li>1) Install an LC filter at the power supply side of the inverter. (In some cases, a capacitive filter may be used as a simple method.)</li> <li>2) Install a metal conduit wiring between the motor and inverter. Or use shielded wiring.</li> </ol>  <p>Note: Minimize the distance between the LC filter and inverter as much as possible (within 1m).</p>	<ol style="list-style-type: none"> <li>1) The radiation noise of the wiring can be reduced.</li> <li>2) The conduction noise to the power supply side can be reduced.</li> </ol> <p>Note: Sufficient improvement may not be expected in narrow regions such as between mountains.</p>
2	AM radio	<p>When operating an inverter, noise enters into an AM radio broadcast (500 to 1500 kHz).</p>  <p>&lt;Possible cause&gt; The AM radio may receive noise radiated from the power line at the power supply side of the inverter.</p>	<ol style="list-style-type: none"> <li>1) Install inductive filters at the input and output sides of the inverter.</li> </ol>  <p>The number of turns of the zero-phase reactor (or ferrite ring) should be as large as possible. In addition, wiring between the inverter and the zero-phase reactor (or ferrite ring) should be as short as possible. (within 1m)</p> <ol style="list-style-type: none"> <li>2) When further improvement is necessary, install LC filters.</li> </ol> 	<ol style="list-style-type: none"> <li>1) The radiation noise of the wiring can be reduced.</li> </ol>

Table A.2 Continued

No.	Target device	Phenomena	Noise prevention measures	Notes
3	Telephone (in a common private residence at a distance of 40 m)	<p>When driving a ventilation fan with an inverter, noise enters a telephone in a private residence at a distance of 40 m.</p>  <p>&lt;Possible cause&gt; A high-frequency leakage current from the inverter and motor flowed to grounded part of the telephone cable shield. During the current's return trip, it flowed through a grounded pole transformer, and noise entered the telephone by electrostatic induction.</p>	<p>1) Connect the ground terminals of the motors in a common connection. Return to the inverter panel, and insert a 1 μF capacitor between the input terminal of the inverter and ground.</p>  	<p>1) The effect of the inductive filter and LC filter may not be expected because of sound frequency component.</p> <p>2) In the case of a V-connection power supply transformer in a 200V system, it is necessary to connect capacitors as shown in the following figure, because of different potentials to ground.</p>
4	Photoelectric relay	<p>A photoelectric relay malfunctioned when the inverter runs the motor.</p> <p>[The inverter and motor are installed in the same place (for overhead traveling)]</p>  <p>&lt;Possible cause&gt; It is considered that induction noise entered the photoelectric relay since the inverter's input power supply line and the photoelectric relay's wiring are in parallel separated by approximately 25 mm over a distance of 30 to 40 m. Due to conditions of the installation, these lines cannot be separated.</p>	<p>1) As a temporary measure, Insert a 0.1 μF capacitor between the 0 V terminal of the power supply circuit in the detection unit of the overhead photoelectric relay and a frame of the overhead panel.</p>  <p>2) As a permanent measure, move the 24 V power supply from the ground to the overhead unit so that signals are sent to the ground side with relay contacts in the ceiling part.</p>	<p>1) The wiring is separated by more than 30 cm.</p> <p>2) When separation is impossible, signals can be received and sent with dry contacts etc.</p> <p>3) Do not wire weak-current signal lines and power lines in parallel.</p>

App.

Table A.2 Continued

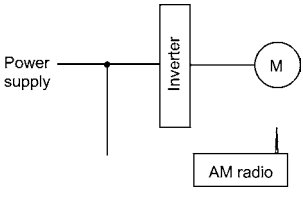
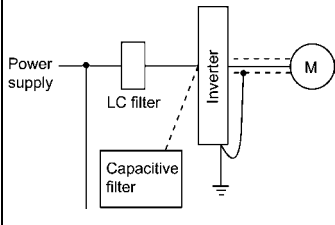
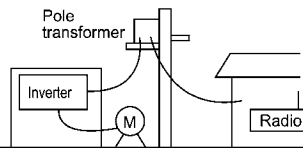
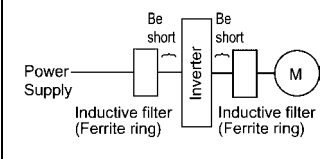
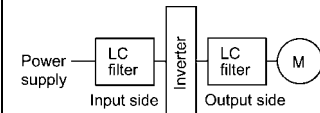
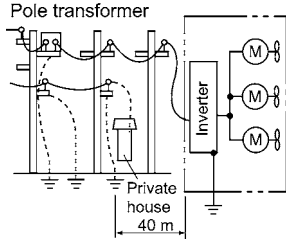
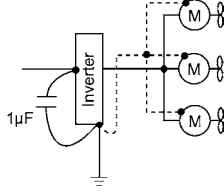
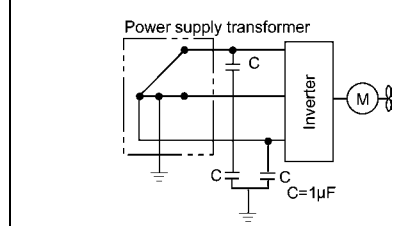
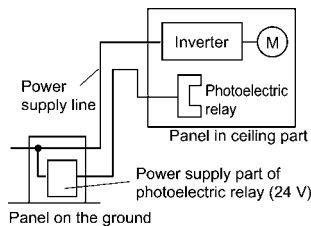
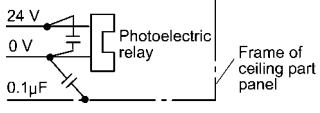
No.	Target device	Phenomena	Noise prevention measures	Notes
5	Photo-electric relay	<p>A photoelectric relay malfunctioned when the inverter was operated.</p>  <p>&lt;Possible cause&gt; Although the inverter and photoelectric relay are separated by a sufficient distance but the power supplies share a common connection, it is considered that conduction noise entered through the power supply line into the photoelectric relay.</p>	<p>1) Insert a 0.1 μF capacitor between the output common terminal of the amplifier of the photoelectric relay and the frame.</p> 	<p>1) If a weak-current circuit at the malfunctioning side is observed, the measures may be simple and economical.</p>
6	Proximity limit switch (electrostatic type)	<p>A proximity limit switch malfunctioned.</p>  <p>&lt;Possible cause&gt; It is considered that the capacitance type proximity limit switch is susceptible to conduction and radiation noise because of its low noise immunity.</p>	<p>1) Install an LC filter at the output side of the inverter. 2) Install a capacitive filter at the input side of the inverter. 3) Ground the 0 V (common) line of the DC power supply of the proximity limit switch through a capacitor to the box body of the machine.</p> 	<p>1) Noise generated in the inverter can be reduced. 2) The switch is superseded by a proximity limit switch of superior noise immunity (such as a magnetic type).</p>



Table A.2 Continued

No.	Target device	Phenomena	Noise prevention measures	Notes
7	Pressure sensor	<p>A pressure sensor malfunctioned.</p>  <p>&lt;Possible cause&gt; The pressure sensor may malfunction due to noise that came from the box housing through the shielded wire.</p>	<ol style="list-style-type: none"> <li>1) Install an LC filter on the input side of the inverter.</li> <li>2) Connect the shield of the shielded wire of the pressure sensor to the 0 V line (common) of the pressure sensor, changing the original connection.</li> </ol> 	<ol style="list-style-type: none"> <li>1) The shielded parts of shield wires for sensor signals are connected to a common point in the system.</li> <li>2) Conduction noise from the inverter can be reduced.</li> </ol>
8	Position detector (pulse generator : PG)	<p>Erroneous-pulse outputs from a pulse converter caused a shift in the stop position of a crane.</p>  <p>&lt;Possible cause&gt; Erroneous pulses may be outputted by induction noise since the power line of the motor and the signal line of the PG are bundled together.</p>	<ol style="list-style-type: none"> <li>1) Install an LC filter and a capacitive filter at the input side of the inverter.</li> <li>2) Install an LC filter at the output side of the inverter.</li> </ol> 	<ol style="list-style-type: none"> <li>1) This is an example of a measure where the power line and signal line cannot be separated.</li> <li>2) Induction noise and radiation noise at the output side of the inverter can be reduced.</li> </ol>
9	Program mable logic controller (PLC)	<p>The PLC program sometimes malfunctions.</p>  <p>&lt;Possible cause&gt; Since the power supply system is the same for the PLC and inverter, it is considered that noise enters the PLC through the power supply.</p>	<ol style="list-style-type: none"> <li>1) Install a capacitive filter and an LC filter on the input side of the inverter.</li> <li>2) Install an LC filter on the output side of the inverter.</li> <li>3) Lower the carrier frequency of the inverter.</li> </ol> 	<ol style="list-style-type: none"> <li>1) Total conduction noise and induction noise in the electric line can be reduced.</li> </ol>

App.

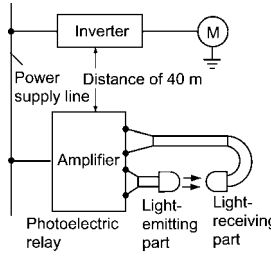
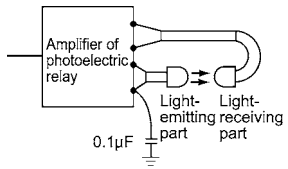
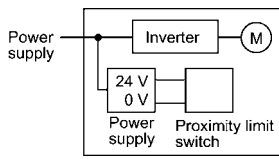
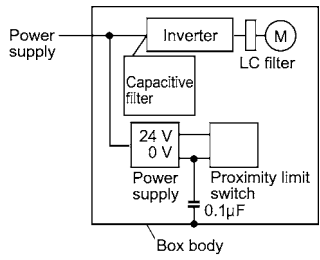
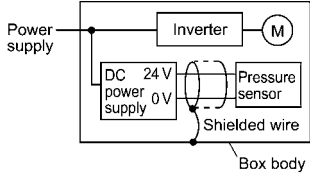
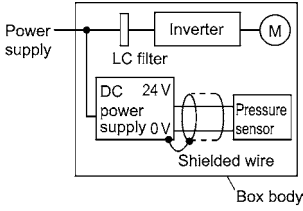
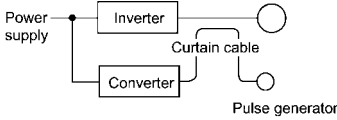
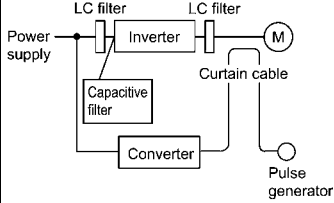
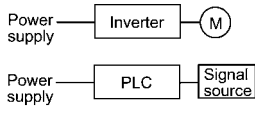
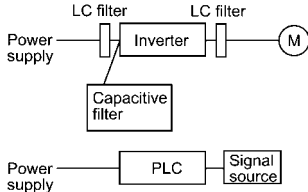
---

## App. B Japanese Guideline for Suppressing Harmonics by Customers Receiving High Voltage or Special High Voltage

- *Disclaimer: This document provides you with a translated summary of the Guideline of the Ministry of International Trade and Industry (September 1994). It is intended to apply to the domestic market only. It is only for reference for the foreign market.* -

Agency of Natural Resource and Energy of Japan published the following two guidelines for suppressing harmonic noise in September 1994.

- (1) Guideline for suppressing harmonics in home electric and general-purpose appliances
- (2) Guideline for suppressing harmonics by customers receiving high voltage or special high voltage

Assuming that electronic devices generating high harmonics will be increasing, these guidelines are to establish regulations for preventing high frequency noise interference on devices sharing the power source. These guidelines should be applied to all devices that are used on the commercial power lines and generate harmonic current. This section gives a description limited to general-purpose inverters.

### B.1 Application to general-purpose inverters

#### [ 1 ] Guideline for suppressing harmonics in home electric and general-purpose appliances

Our three-phase, 200V series inverters of 3.7 kW or less (FRENIC-Mini series) were the products of which were restricted by the "Guideline for Suppressing Harmonics in Home Electric and General-purpose Appliances" (established in September 1994 and revised in October 1999) issued by the Ministry of Economy, Trade and Industry.

The above restriction, however, was lifted when the Guideline was revised in January 2004. Since then, the inverter makers have individually imposed voluntary restrictions on the harmonics of their products.

We, as before, recommend that you connect a reactor (for suppressing harmonics) to your inverter.

#### [ 2 ] Guideline for suppressing harmonics by customers receiving high voltage or special high voltage

Unlike other guidelines, this guideline is not applied to the equipment itself such as a general-purpose inverter, but is applied to each large-scale electric power consumer for total amount of harmonics. The consumer should calculate the harmonics generated from each piece of equipment currently used on the power source transformed and fed from the high or special high voltage source.

##### (1) Scope of regulation

In principle, the guideline applies to the customers that meet the following two conditions:

- The customer receives high voltage or special high voltage.
- The "equivalent capacity" of the converter load exceeds the standard value for the receiving voltage (50 kVA at a receiving voltage of 6.6 kV).

Appendix B.2 [1] "Calculation of equivalent capacity (Pi)" gives you some supplemental information with regard to estimation for the equivalent capacity of an inverter according to the guideline.

(2) Regulation

The level (calculated value) of the harmonic current that flows from the customer's receiving point out to the system is subjected to the regulation. The regulation value is proportional to the contract demand. The regulation values specified in the guideline are shown in Table B.1.

Appendix B.2 gives you some supplemental information with regard to estimation for the equivalent capacity of the inverter for compliance to "Japanese guideline for suppressing harmonics by customers receiving high voltage or special high voltage."

Table B.1 Upper Limits of Harmonic Outflow Current per kW of Contract Demand (mA/kW)

Receiving voltage	5th	7th	11th	13th	17th	19th	23rd	Over 25th
6.6 kV	3.5	2.5	1.6	1.3	1.0	0.90	0.76	0.70
22 kV	1.8	1.3	0.82	0.69	0.53	0.47	0.39	0.36

(3) When the regulation applied

The guideline has been applied. As the application, the estimation for "Voltage waveform distortion rate" required as the indispensable conditions when entering into the consumer's contract of electric power is already expired.

## B.2 Compliance to the harmonic suppression for customers receiving high voltage or special high voltage

When calculating the required matters related to inverters according to the guideline, follow the terms listed below. The following descriptions are based on "Technical document for suppressing harmonics" (JECE 9702-1995) published by the Japan Electrical Manufacturer's Association (JEMA).

[ 1 ] Calculation of equivalent capacity (Pi)

The equivalent capacity (Pi) may be calculated using the equation of (input rated capacity) x (conversion factor). However, catalogs of conventional inverters do not contain input rated capacities, so a description of the input rated capacity is shown below:

(1) "Inverter rated capacity" corresponding to "Pi"

- In the guideline, the conversion factor of a 6-pulse converter is used as reference conversion factor 1. It is, therefore, necessary to express the rated input capacity of inverters in a value including harmonic component current equivalent to conversion factor 1.
- Calculate the input fundamental current I<sub>1</sub> from the kW rating and efficiency of the load motor, as well as the efficiency of the inverter. Then, calculate the input rated capacity as shown below:

$$\text{Input rated capacity} = \sqrt{3} \times (\text{power supply voltage}) \times I_1 \times 1.0228/1000 \text{ (kVA)}$$

where 1.0228 is the 6-pulse converter's value of (effective current)/(fundamental current).

- When a general-purpose motor or inverter motor is used, the appropriate value shown in Table B.2 can be used. Select a value based on the kW rating of the motor used, irrespective of the inverter type.

 The input rated capacity shown above is for the dedicated use in the equation to calculate capacity of the inverters, following the guideline. Note that the capacity can not be applied to the reference for selection of the equipment or wires to be used in the inverter input circuits.

 For selection of capacity for the peripheral equipment, refer to the catalogs or technical documents issued from their manufacturers.

Table B.2 "Input Rated Capacities" of General-purpose Inverters Determined by the Applicable Motor Ratings

Applicable motor rating (kW)		0.1	0.2	0.4	0.75	1.5	2.2	3.7	5.5	7.5	11	15	18.5
Pi (kVA)	200V	0.22	0.35	0.57	0.97	1.95	2.81	4.61	6.77	9.07	13.1	17.6	21.8
	400V	0.22	0.35	0.57	0.97	1.95	2.81	4.61	6.77	9.07	13.1	17.6	21.8

(2) Values of "Ki (conversion factor)"

Depending on whether an optional ACR (AC reactor) or DCR (DC reactor) is used, apply the appropriate conversion factor specified in the appendix to the guideline. The values of the conversion factor are listed in Table B.3.

Table B.3 "Conversion Factors Ki" for General-purpose Inverters Determined by Reactors

Circuit category	Circuit type		Conversion factor Ki	Main applications
3	3-phase bridge (capacitor smoothing)	w/o reactor	K31=3.4	<ul style="list-style-type: none"> <li>• General-purpose inverters</li> <li>• Elevators</li> <li>• Refrigerators, air conditioning systems</li> <li>• Other general appliances</li> </ul>
		w/- reactor (ACR)	K32=1.8	
		w/- reactor (DCR)	K33=1.8	
		w/- reactors (ACR and DCR)	K34=1.4	

**Note** Some models are equipped with a reactor as a built-in standard accessory.

(3) Exception to this guideline

Inverters whose inputs are 100V or 200V lines and capacities are 3.7 (4.0) kW or less are an exception to this guideline.

Those excluded inverters are already regulated by the "Japanese guideline for suppressing harmonics in home electric and general-purpose appliances" so that all of them are not regulated by this guideline regardless of the quantity of the units used by a single customer.

[ 2 ] Calculation of Harmonic Current

(1) Value of "input fundamental current"

- When you calculate the amount of harmonics according to Table 2 in Appendix of the Guideline, you have to previously know the input fundamental current.
- Apply the appropriate value shown in Table B.4 based on the kW rating of the motor, irrespective of the inverter type or whether a reactor is used.

**Note** If the input voltage is different, calculate the input fundamental current in inverse proportion to the voltage.

Table B.4 "Input Fundamental Currents" of General-purpose Inverters Determined by the Applicable Motor Ratings

Applicable motor rating (kW)		0.1	0.2	0.4	0.75	1.5	2.2	3.7	5.5	7.5	11	15	18.5
Input fundamental current (A)	Three-phase 200V	0.61	0.98	1.61	2.74	5.50	7.93	13.0	19.1	25.6	36.9	49.8	61.4
	Three-phase 400V	0.30	0.49	0.81	1.37	2.75	3.96	6.50	9.55	12.8	18.5	24.9	30.7
6.6 kV converted value (mA)		18	30	49	83	167	240	394	579	776	1121	1509	1860

Applicable motor rating (kW)		0.1	0.2	0.4	0.75	1.5	2.2	-	-	-	-	-	-
Input fundamental current (A)	Single-phase 200V	1.05	1.70	2.81	4.76	9.51	13.7	-	-	-	-	-	-
	Single-phase 100V	1.70	3.40	5.61	9.51	-	-	-	-	-	-	-	-
6.6 kV converted value (mA)		18	30	49	83	167	240	-	-	-	-	-	-

(2) Calculation of harmonic current

Usually, calculate the harmonic current according to the Sub-table 3 "Three phase bridge rectifier with the filtering capacitor" in Table 2 of the Guideline's Appendix. Table B.5 lists the contents of the Sub-table 3.

Table B.5 Generated Harmonic Current (%), 3-phase Bridge Rectifier (Capacitor Filtering)

Degree	5th	7th	11th	13th	17th	19th	23rd	25th
w/o a reactor	65	41	8.5	7.7	4.3	3.1	2.6	1.8
w/- a reactor (ACR)	38	14.5	7.4	3.4	3.2	1.9	1.7	1.3
w/- a reactor (DCR)	30	13	8.4	5.0	4.7	3.2	3.0	2.2
w/- reactors (ACR and DCR)	28	9.1	7.2	4.1	3.2	2.4	1.6	1.4

- ACR: 3%
- DCR: Accumulated energy equal to 0.08 to 0.15 ms (100% load conversion)
- Smoothing capacitor: Accumulated energy equal to 15 to 30 ms (100% load conversion)
- Load: 100%

Calculate the harmonic current of each degree using the following equation:

$$\text{nth harmonic current (A)} = \text{Fundamental current (A)} \times \frac{\text{Generated nth harmonic current (\%)}}{100}$$

(3) Maximum availability factor

- For a load for elevators, which provides intermittent operation, or a load with a sufficient designed motor rating, reduce the current by multiplying the equation by the "maximum availability factor" of the load.
- The "maximum availability factor of an appliance" means the ratio of the capacity of the harmonic generator in operation at which the availability reaches the maximum, to its total capacity, and the capacity of the generator in operation is an average for 30 minutes.
- In general, the maximum availability factor is calculated according to this definition, but the standard values shown in Table B.6 are recommended for inverters for building equipment.

Table B.6 Availability Factors of Inverters, etc. for Building Equipment (Standard Values)

Equipment type	Inverter capacity category	Single inverter availability
Air conditioning system	200 kW or less	0.55
	Over 200 kW	0.60
Sanitary pump	-----	0.30
Elevator	-----	0.25
Refrigerator, freezer	50 kW or less	0.60
UPS (6-pulse)	200 kVA	0.60

### Correction coefficient according to contract demand level

Since the total availability factor decreases if the scale of a building increases, calculating reduced harmonics with the correction coefficient  $\beta$  defined in Table B.7 is permitted.

Table B.7 Correction Coefficient according to the Building Scale

Contract demand (kW)	Correction coefficient $\beta$
300	1.00
500	0.90
1000	0.85
2000	0.80

Note: If the contract demand is between two specified values listed in Table B.7, calculate the value by interpolation.

Note: The correction coefficient  $\beta$  is to be determined as a matter of consultation between the customer and electric power supplier for the customers receiving the electric power over 2000 kW or from the special high voltage lines.

#### (4) Degree of harmonics to be calculated

The higher the degree of harmonics, the lower the current flows. This is the property of harmonics generated by inverters so that the inverters are covered by "The case not causing a special hazard" of the term (3) in the above Appendix for the 9th or higher degrees of the harmonics.

Therefore, "It is sufficient that the 5th and 7th harmonic currents should be calculated."

### [ 3 ] Examples of calculation

#### (1) Equivalent capacity

Example of loads	Input capacity and No. of inverters	Conversion factor	Equivalent capacity
[Example 1] 400V, 3.7 kW, 10 units w/- AC reactor and DC reactor	4.61 kVA×10 units	K32 = 1.4	4.61 × 10 × 1.4 = 64.54 kVA
[Example 2] 400V, 1.5 kW, 15 units w/- AC reactor	2.93 kVA×15 units	K34 = 1.8	2.93 × 15 × 1.8 = 79.11 kVA
	Refer to Table B.2.	Refer to Table B.3.	

#### (2) Harmonic current every degrees

[Example 1] 400V, 3.7 kW, 10 units, w/- AC reactor, and maximum availability: 0.55

Fundamental current onto 6.6 kV lines (mA)	Harmonic current onto 6.6 kV lines (mA)							
	5th (38%)	7th (14.5%)	11th (7.4%)	13th (3.4%)	17th (3.2%)	19th (1.9%)	23rd (1.7%)	25th (1.3%)
394×10= 3940 3940×0.55= 2167	823.5	314.2						
Refer to Tables B.4 and B.6.	Refer to Table B.5.							

[Example 2] 400V, 3.7 kW, 15 units, w/- AC reactor and DC reactor, and maximum availability: 0.55

Fundamental current onto 6.6 kV lines (mA)	Harmonic current onto 6.6 kV lines (mA)							
	5th (28%)	7th (9.1%)	11th (7.2%)	13th (4.1%)	17th (3.2%)	19th (2.4%)	23rd (1.6%)	25th (1.4%)
394×15= 5910 5910×0.55= 3250.5	910.1	295.8						
Refer to Tables B.4 and B.6.	Refer to Table B.5.							

## App. C Effect on Insulation of General-purpose Motors Driven with 400 V Class Inverters

- Disclaimer: This document provides you with a summary of the Technical Document of the Japan Electrical Manufacturers' Association (JEMA) (March, 1995). It is intended to apply to the domestic market only. It is only for reference for the foreign market. -

### Preface

When an inverter drives a motor, surge voltages generated by switching the inverter elements are superimposed on the inverter output voltage and applied to the motor terminals. If the surge voltages are too high they may have an effect on the motor insulation and some cases have resulted in damage.

For preventing such cases this document describes the generating mechanism of the surge voltages and countermeasures against them.

 Refer to A.2 [1] "Inverter noise" for details of the principle of inverter operation.

### C.1 Generating mechanism of surge voltages

As the inverter rectifies a commercial power source voltage and smoothes into a DC voltage, the magnitude  $E$  of the DC voltage becomes about  $\sqrt{2}$  times that of the source voltage (about 620V in case of an input voltage of 440 VAC). The peak value of the output voltage is usually close to this DC voltage value.

But, as there exists inductance ( $L$ ) and stray capacitance ( $C$ ) in wiring between the inverter and the motor, the voltage variation due to switching the inverter elements causes a surge voltage originating in LC resonance and results in the addition of high voltage to the motor terminals. (Refer to Figure C.1)

This voltage sometimes reaches up to about twice that of the inverter DC voltage ( $620\text{V} \times 2 =$  approximately 1,200V) depending on a switching speed of the inverter elements and wiring conditions.

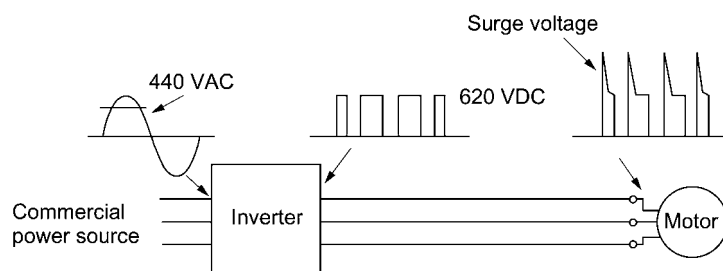
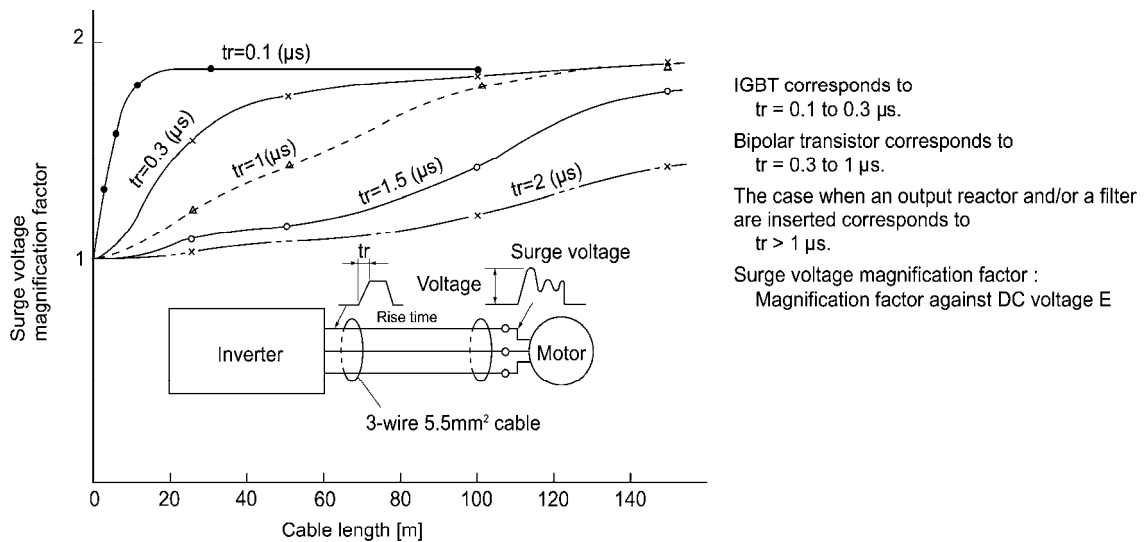

Figure C.1 Voltage Wave Shapes of Individual Portions

A measured example in Figure C.2 illustrates the relation of a peak value of the motor terminal voltage with a wiring length between the inverter and the motor.

From this it can be confirmed that the peak value of the motor terminal voltage ascends as the wiring length increases and becomes saturated at about twice the inverter DC voltage.

The shorter a pulse rise time becomes, the higher the motor terminal voltage rises even in the case of a short wiring length.



Excerpt from [J. IEE Japan, Vol. 107, No. 7, 1987]

Figure C.2 Measured Example of Wiring Length and Peak Value of Motor Terminal Voltage

## C.2 Effect of surge voltages

The surge voltages originating in LC resonance of wiring may be applied to the motor input terminals and depending on their magnitude sometimes cause damage to the motor insulation.

When the motor is driven with a 200 V class inverter, the dielectric strength of the insulation is no problem since the peak value at the motor terminal voltage increases twice due to the surge voltages (the DC voltage is only about 300 V).

But in case of a 400 V class inverter the DC voltage is approximately 600 V and depending on the wiring length, the surge voltages may greatly increase and sometimes result in damage to the insulation.

## C.3 Countermeasures against surge voltages

The following methods are countermeasures against damage to the motor insulation by the surge voltages and using a motor driven with a 400 V class inverter.

[ 1 ] Using a surge suppressor unit, SSU (Patent pending)

The surge suppressor unit (SSU) is a newly structured unit using circuits based on the impedance-matching theory of a transmission line. Just connecting the SSU to the surge suppressor cable of the existing equipment can greatly reduce the surge voltage that results in a motor dielectric breakdown.



For 50 m of wiring length: SSU 50TA-NS



For 100 m of wiring length: SSU 100TA-NS



[ 2 ] Method using motors with enhanced insulation

Enhanced insulation of a motor winding allows its surge proof strength to be improved.

[ 3 ] Method to suppress surge voltages

There are two methods for suppressing the surge voltages, one is to reduce the voltage rise time and another is to reduce the voltage peak value.

(1) Output reactor

If wiring length is relatively short the surge voltages can be suppressed by reducing the voltage rise time (dv/dt) with the installation of an AC reactor on the output side of the inverter. (Refer to Figure C.3 (1).)

However, if the wiring length becomes long, suppressing the peak voltage due to surge voltage may be difficult.

(2) Output filter

Installing a filter on the output side of the inverter allows a peak value of the motor terminal voltage to be reduced. (Refer to Figure C.3 (2).)

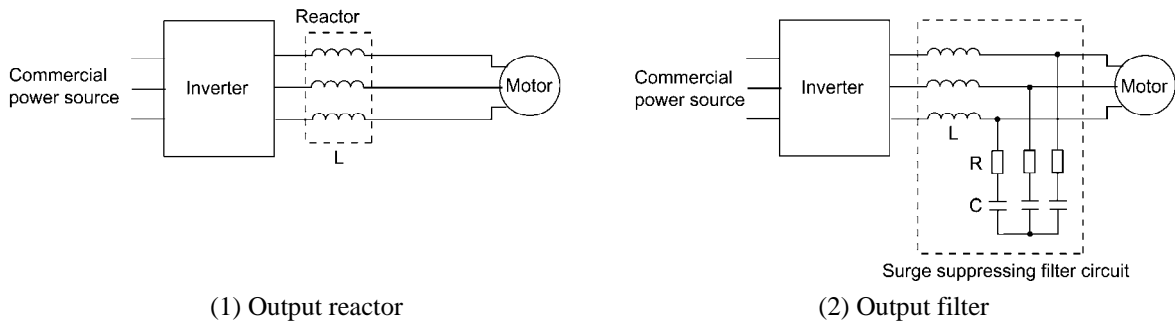

Figure C.3 Method to Suppress Surge Voltage

## C.4 Regarding existing equipment

[ 1 ] In case of a motor being driven with 400 V class inverter

A survey over the last five years on motor insulation damage due to the surge voltages originating from switching of inverter elements shows that the damage incidence is 0.013% under the surge voltage condition of over 1,100 V and most of the damage occurs several months after commissioning the inverter. Therefore there seems to be little probability of occurrence of motor insulation damage after a lapse of several months of commissioning.

[ 2 ] In case of an existing motor driven using a newly installed 400 V class inverter

We recommend suppressing the surge voltages with the method of Section C.3.

## App. D Inverter Generating Loss

The table below lists the inverter generating loss.

Power supply voltage	Applicable motor rating (kW)	Inverter type	Generating loss (W)	
			Low carrier frequency (2 kHz)	High carrier frequency (15 kHz)
Three-phase 200 V	0.1	FRN0001C2S-2□	20	23
	0.2	FRN0002C2S -2□	27	32
	0.4	FRN0004C2S-2□	40	50
	0.75	FRN0006C2S-2□	60	77
	1.5	FRN0010C2S-2□	91	110
	2.2	FRN0012C2S-2□	128	165
	3.7	FRN0020C2S-2□	203	260
	5.5	FRN0025C2S-2□	240	300
	7.5	FRN0033C2S-2□	280	350
	11	FRN0047C2S-2□	440	520
15	FRN0060C2S-2□	520	680	
Three-phase 400 V	0.4	FRN0002C2S-4□	28	45
	0.75	FRN0004C2S-4□	41	64
	1.5	FRN0005C2S-4□	63	103
	2.2	FRN0007C2S-4□	89	149
	3.7/4.0	FRN0011C2S-4□	135	235
	5.5	FRN0013C2S-4□	170	300
	7.5	FRN0018C2S-4□	220	380
	11	FRN0024C2S-4□	300	480
15	FRN0030C2S-4□	330	580	
Single-phase 200 V	0.1	FRN0001C2S-7□	21	24
	0.2	FRN0002C2S-7□	29	34
	0.4	FRN0004C2S-7□	41	51
	0.75	FRN0006C2S-7□	64	80
	1.5	FRN0010C2S-7□	101	129
	2.2	FRN0012C2S-7□	143	180
Single-phase 100 V	0.1	FRN0001C2S-6U	21	24
	0.2	FRN0002C2S-6U	31	36
	0.4	FRN0003C2S-6U	53	63
	0.75	FRN0005C2S-6U	89	106

Note: A box (□) in the above table replaces A, C, E, or U depending on shipping destination.

## App. E Conversion from SI Units

All expressions given in Chapter 7, "SELECTING OPTIMAL MOTOR AND INVERTER CAPACITIES" are based on SI units (International Metric System of Units). This section explains how to convert expressions to other units.

### [ 1 ] Conversion of units

#### (1) Force

- 1 (kgf)  $\approx$  9.8 (N)
- 1 (N)  $\approx$  0.102 (kgf)

#### (2) Torque

- 1 (kgf·m)  $\approx$  9.8 (N·m)
- 1 (N·m)  $\approx$  0.102 (kgf·m)

#### (3) Work and Energy

- 1 (kgf·m)  $\approx$  9.8 (N·m) = 9.8(J) = 9.8 (W·s)

#### (4) Power

- 1 (kgf·m/s)  $\approx$  9.8 (N·m/s) = 9.8 (J/s) = 9.8(W)
- 1 (N·m/s)  $\approx$  1 (J/s) = 1 (W)  $\approx$  0.102 (kgf·m/s)

#### (5) Rotation speed

- 1 (r/min) =  $\frac{2\pi}{60}$  (rad/s)  $\approx$  0.1047 (rad/s)
- 1 (rad/s) =  $\frac{60}{2\pi}$  (r/min)  $\approx$  9.549 (r/min)

#### (6) Inertia constant

- J (kg·m<sup>2</sup>) :moment of inertia
- GD<sup>2</sup> (kg·m<sup>2</sup>) :flywheel effect

- GD<sup>2</sup> = 4 J

- $J = \frac{GD^2}{4}$

#### (7) Pressure and stress

- 1 (mmAq)  $\approx$  9.8 (Pa)  $\approx$  9.8 (N/m<sup>2</sup>)
- 1(Pa)  $\approx$  1(N/m<sup>2</sup>)  $\approx$  0.102 (mmAq)
- 1 (bar)  $\approx$  100000 (Pa)  $\approx$  1.02 (kg·cm<sup>-2</sup>)
- 1 (kg·cm<sup>-2</sup>)  $\approx$  98000 (Pa)  $\approx$  980 (mbar)
- 1 atmospheric pressure = 1013 (mbar) = 760 (mmHg) = 101300 (Pa)  $\approx$  1.033 (kg/cm<sup>2</sup>)

## [ 2 ] Calculation formula

### (1) Torque, power, and rotation speed

- $P \text{ (W)} \approx \frac{2\pi}{60} \cdot N \text{ (r/min)} \cdot \tau \text{ (N} \cdot \text{m)}$
- $P \text{ (W)} \approx 1.026 \cdot N \text{ (r/min)} \cdot T \text{ (kgf} \cdot \text{m)}$
- $\tau \text{ (N} \cdot \text{m)} \approx 9.55 \cdot \frac{P \text{ (W)}}{N \text{ (r/min)}}$
- $T \text{ (kgf} \cdot \text{m)} \approx 0.974 \cdot \frac{P \text{ (W)}}{N \text{ (r/min)}}$

### (2) Kinetic energy

- $E \text{ (J)} \approx \frac{1}{182.4} \cdot J \text{ (kg} \cdot \text{m}^2) \cdot N^2 \text{ [(r/min)}^2]$
- $E \text{ (J)} \approx \frac{1}{730} \cdot GD^2 \text{ (kg} \cdot \text{m}^2) \cdot N^2 \text{ [(r/min)}^2]$

### (3) Torque of linear moving load

#### Driving mode

- $\tau \text{ (N} \cdot \text{m)} \approx 0.159 \cdot \frac{V \text{ (m/min)}}{N_M \text{ (r/min)} \cdot \eta_G} \cdot F \text{ (N)}$
- $T \text{ (kgf} \cdot \text{m)} \approx 0.159 \cdot \frac{V \text{ (m/min)}}{N_M \text{ (r/min)} \cdot \eta_G} \cdot F \text{ (kgf)}$

#### Braking mode

- $\tau \text{ (N} \cdot \text{m)} \approx 0.159 \cdot \frac{V \text{ (m/min)}}{N_M \text{ (r/min)} / \eta_G} \cdot F \text{ (N)}$
- $T \text{ (kgf} \cdot \text{m)} \approx 0.159 \cdot \frac{V \text{ (m/min)}}{N_M \text{ (r/min)} / \eta_G} \cdot F \text{ (kgf)}$

### (4) Acceleration torque

#### Driving mode

- $\tau \text{ (N} \cdot \text{m)} \approx \frac{J \text{ (kg} \cdot \text{m}^2)}{9.55} \cdot \frac{\Delta N \text{ (r/min)}}{\Delta t \text{ (s)}} \cdot \eta_G$
- $T \text{ (kgf} \cdot \text{m)} \approx \frac{GD^2 \text{ (kg} \cdot \text{m}^2)}{375} \cdot \frac{\Delta N \text{ (r/min)}}{\Delta t \text{ (s)}} \cdot \eta_G$

#### Braking mode

- $\tau \text{ (N} \cdot \text{m)} \approx \frac{J \text{ (kg} \cdot \text{m}^2)}{9.55} \cdot \frac{\Delta N \text{ (r/min)} \cdot \eta_G}{\Delta t \text{ (s)}}$
- $T \text{ (kgf} \cdot \text{m)} \approx \frac{GD^2 \text{ (kg} \cdot \text{m}^2)}{375} \cdot \frac{\Delta N \text{ (r/min)} \cdot \eta_G}{\Delta t \text{ (s)}}$

### (5) Acceleration time

- $t_{\text{ACC}} \text{ (s)} \approx \frac{J_1 + J_2 / \eta_G \text{ (kg} \cdot \text{m}^2)}{\tau_M - \tau_L / \eta_G \text{ (N} \cdot \text{m)}} \cdot \frac{\Delta N \text{ (r/min)}}{9.55}$
- $t_{\text{ACC}} \text{ (s)} \approx \frac{GD_1^2 + GD_2^2 / \eta_G \text{ (kg} \cdot \text{m}^2)}{T_M - T_L / \eta_G \text{ (kgf} \cdot \text{m)}} \cdot \frac{\Delta N \text{ (r/min)}}{375}$

### (6) Deceleration time

- $t_{\text{DEC}} \text{ (s)} \approx \frac{J_1 + J_2 \cdot \eta_G \text{ (kg} \cdot \text{m}^2)}{\tau_M - \tau_L \cdot \eta_G \text{ (N} \cdot \text{m)}} \cdot \frac{\Delta N \text{ (r/min)}}{9.55}$
- $t_{\text{DEC}} \text{ (s)} \approx \frac{GD_1^2 + GD_2^2 \cdot \eta_G \text{ (kg} \cdot \text{m}^2)}{T_M - T_L \cdot \eta_G \text{ (kgf} \cdot \text{m)}} \cdot \frac{\Delta N \text{ (r/min)}}{375}$

## App. F Allowable Current of Insulated Wires

The tables below list the allowable current of IV wires, HIV wires, and 600 V class of cross-linked polyethylene-insulated wires.

■ IV wires (Maximum allowable temperature: 60°C)

Table F.1 (a) Allowable Current of Insulated Wires

Wire size (mm <sup>2</sup> )	Allowable current reference value (up to 30°C) I <sub>0</sub> (A)	Wiring outside duct					Wiring in the duct (Max. 3 wires in one duct)			
		35°C (I <sub>0</sub> ×0.91) (A)	40°C (I <sub>0</sub> ×0.82) (A)	45°C (I <sub>0</sub> ×0.71) (A)	50°C (I <sub>0</sub> ×0.58) (A)	55°C (I <sub>0</sub> ×0.40) (A)	35°C (I <sub>0</sub> ×0.63) (A)	40°C (I <sub>0</sub> ×0.57) (A)	45°C (I <sub>0</sub> ×0.49) (A)	50°C (I <sub>0</sub> ×0.40) (A)
2.0	27	24	22	19	15	11	17	15	13	10
3.5	37	33	30	26	21	15	23	21	18	14
5.5	49	44	40	34	28	20	30	27	24	19
8.0	61	55	50	43	35	25	38	34	29	24
14	88	80	72	62	51	36	55	50	43	35
22	115	104	94	81	66	47	72	65	56	46
38	162	147	132	115	93	66	102	92	79	64
60	217	197	177	154	125	88	136	123	106	86
100	298	271	244	211	172	122	187	169	146	119
150	395	359	323	280	229	161	248	225	193	158
200	469	426	384	332	272	192	295	267	229	187
250	556	505	455	394	322	227	350	316	272	222
325	650	591	533	461	377	266	409	370	318	260
400	745	677	610	528	432	305	469	424	365	298
500	842	766	690	597	488	345	530	479	412	336
2 x 100	497	452	407	352	288	203	313	283	243	198
2 x 150	658	598	539	467	381	269	414	375	322	263
2 x 200	782	711	641	555	453	320	492	445	383	312
2 x 250	927	843	760	658	537	380	584	528	454	370
2 x 325	1083	985	888	768	628	444	682	617	530	433
2 x 400	1242	1130	1018	881	720	509	782	707	608	496
2 x 500	1403	1276	1150	996	813	575	883	799	687	561

■ HIV wires (Maximum allowable temperature: 75°C)

Table F.1 (b) Allowable Current of Insulated Wires

Wire size (mm <sup>2</sup> )	Allowable current reference value (up to 30°C) I <sub>0</sub> (A)	Wiring outside duct					Wiring in the duct (Max. 3 wires in one duct)			
		35°C (I <sub>0</sub> ×0.91) (A)	40°C (I <sub>0</sub> ×0.82) (A)	45°C (I <sub>0</sub> ×0.71) (A)	50°C (I <sub>0</sub> ×0.58) (A)	55°C (I <sub>0</sub> ×0.40) (A)	35°C (I <sub>0</sub> ×0.63) (A)	40°C (I <sub>0</sub> ×0.57) (A)	45°C (I <sub>0</sub> ×0.49) (A)	50°C (I <sub>0</sub> ×0.40) (A)
2.0	32	31	29	27	24	22	21	20	18	17
3.5	45	42	39	37	33	30	29	27	25	23
5.5	59	56	52	49	44	40	39	36	34	30
8.0	74	70	65	61	55	50	48	45	42	38
14	107	101	95	88	80	72	70	66	61	55
22	140	132	124	115	104	94	92	86	80	72
38	197	186	174	162	147	132	129	121	113	102
60	264	249	234	217	197	177	173	162	151	136
100	363	342	321	298	271	244	238	223	208	187
150	481	454	426	395	359	323	316	296	276	248
200	572	539	506	469	426	384	375	351	328	295
250	678	639	600	556	505	455	444	417	389	350
325	793	747	702	650	591	533	520	487	455	409
400	908	856	804	745	677	610	596	558	521	469
500	1027	968	909	842	766	690	673	631	589	530
2 x 100	606	571	536	497	452	407	397	372	347	313
2 x 150	802	756	710	658	598	539	526	493	460	414
2 x 200	954	899	844	782	711	641	625	586	547	492
2 x 250	1130	1066	1001	927	843	760	741	695	648	584
2 x 325	1321	1245	1169	1083	985	888	866	812	758	682
2 x 400	1515	1428	1341	1242	1130	1018	993	931	869	782
2 x 500	1711	1613	1515	1403	1276	1150	1122	1052	982	883

App.

■ 600 V class of Cross-linked Polyethylene-insulated wires (Maximum allowable temperature: 90°C)

Table F.1 (c) Allowable Current of Insulated Wires

Wire size (mm <sup>2</sup> )	Allowable current reference value (up to 30°C) I <sub>0</sub> (A)	Wiring outside duct					Wiring in the duct (Max. 3 wires in one duct)			
		35°C (I <sub>0</sub> ×0.91)	40°C (I <sub>0</sub> ×0.82)	45°C (I <sub>0</sub> ×0.71)	50°C (I <sub>0</sub> ×0.58)	55°C (I <sub>0</sub> ×0.40)	35°C (I <sub>0</sub> ×0.63)	40°C (I <sub>0</sub> ×0.57)	45°C (I <sub>0</sub> ×0.49)	50°C (I <sub>0</sub> ×0.40)
		(A)	(A)	(A)	(A)	(A)	(A)	(A)	(A)	(A)
2.0	38	36	34	32	31	29	25	24	22	21
3.5	52	49	47	45	42	39	34	33	31	29
5.5	69	66	63	59	56	52	46	44	41	39
8.0	86	82	78	74	70	65	57	54	51	48
14	124	118	113	107	101	95	82	79	74	70
22	162	155	148	140	132	124	108	103	97	92
38	228	218	208	197	186	174	152	145	137	129
60	305	292	279	264	249	234	203	195	184	173
100	420	402	384	363	342	321	280	268	253	238
150	556	533	509	481	454	426	371	355	335	316
200	661	633	605	572	539	506	440	422	398	375
250	783	750	717	678	639	600	522	500	472	444
325	916	877	838	793	747	702	611	585	552	520
400	1050	1005	961	908	856	804	700	670	633	596
500	1187	1136	1086	1027	968	909	791	757	715	673
2 x 100	700	670	641	606	571	536	467	447	422	397
2 x 150	927	888	848	802	756	710	618	592	559	526
2 x 200	1102	1055	1008	954	899	844	735	703	664	625
2 x 250	1307	1251	1195	1130	1066	1001	871	834	787	741
2 x 325	1527	1462	1397	1321	1245	1169	1018	974	920	866
2 x 400	1751	1676	1602	1515	1428	1341	1167	1117	1055	993
2 x 500	1978	1894	1809	1711	1613	1515	1318	1262	1192	1122

## App. G Replacement Information

When replacing Fuji conventional inverter series (FVR-C9S, FVR-C11S) with the FRENIC-Mini series, refer to the replacement information given in this section.

### G.1 Compatibility and differences between FRENIC-Mini series FRN□□□□C1□-□□ and FRN□□□□C2□-□□

#### [ 1 ] External form

The original FRENIC-Mini series (FRN□□□□C1□-□□) and upgraded one (FRN□□□□C2□-□□) are fully compatible with each other in external dimensions and mounting dimensions. They are also compatible in the terminal names, number of terminals, main circuit terminal position, and applicable wire sizes.

The differences between the original FRENIC-Mini and upgraded one include the following screws and RJ-45 connector.

The screw type on the control circuit terminal block changes from a Phillips-head screw to slotted one and the lower terminal block shifts 2 mm to the left.

A screw is added to the control circuit terminal block cover to prevent the cover from coming off. (When removing the control circuit terminal block cover, it is necessary to remove the screw.)

An RJ-45 connector for RS-485 communication is added next to the control circuit terminal block so that the external appearance differs when the control circuit terminal block cover is opened.

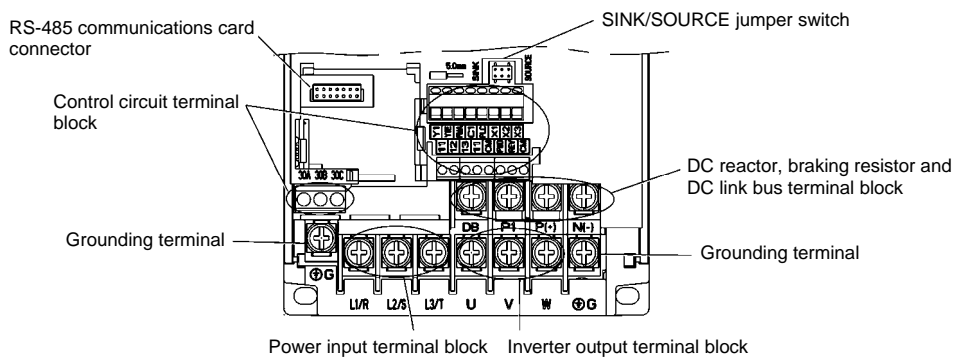

Original FRENIC-Mini FRN1.5C1S-2□

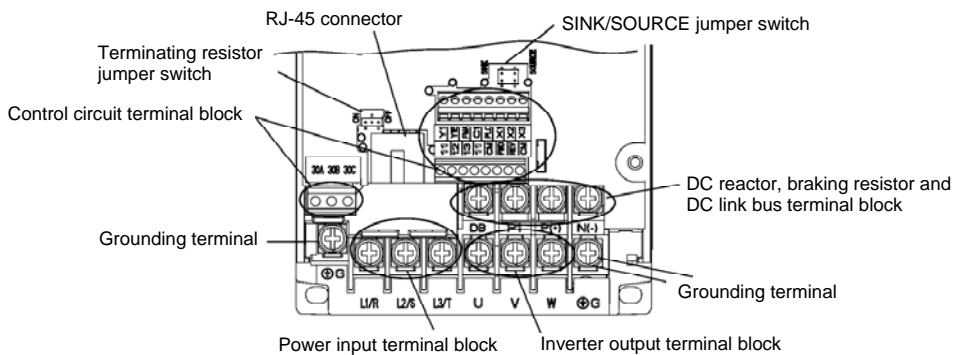

Upgraded FRENIC-Mini FRN0010C2S-2□

Note: A box (□) in model names replaces A, C, E, or U depending on shipping destination.

#### [ 2 ] Function codes

Function codes configured for the original FRENIC-Mini series (FRN□□□□C1□-□□) are upward compatible. Those function codes produce the same operation also on the upgraded FRENIC-Mini series (FRN□□□□C2□-□□).

Note that, on the original FRENIC-Mini series (FRN□□□□C1□-□□), function code H71 (Deceleration characteristics) has no function but can be specified, so H71 may be set to "1." When replacing the original FRENIC-Mini series with the upgraded one, no setting is required.

## G.2 External dimensions comparison tables

Below is a guide that helps in using the comparison tables on the following pages.

- Mounting area /Mini (%) Allows comparing the mounting area required for the FRENIC-Mini series with that for the conventional inverter series in percentage, assuming the area for the FRENIC-Mini series to be 100%. If this value is greater than 100%, it means that the mounting area required for the FRENIC-Mini series is smaller than that of other series.
- Volume/Mini (%) Allows comparing the volume of the FRENIC-Mini series with that of the conventional inverter series in percentage, assuming the volume of the FRENIC-Mini series to be 100%. If this value is greater than 100%, it means that the volume of the FRENIC-Mini is smaller than that of other series.
- In the FRENIC-Mini columns, dimensions in hatched boxes (  ) denote that they are smaller than those of FVR-C9S and FVR-C11S series.
- In the FVR-C11S and FVR-C9S columns, underlined and bolded dimensions denote that they are smaller than those of the FRENIC-Mini series.

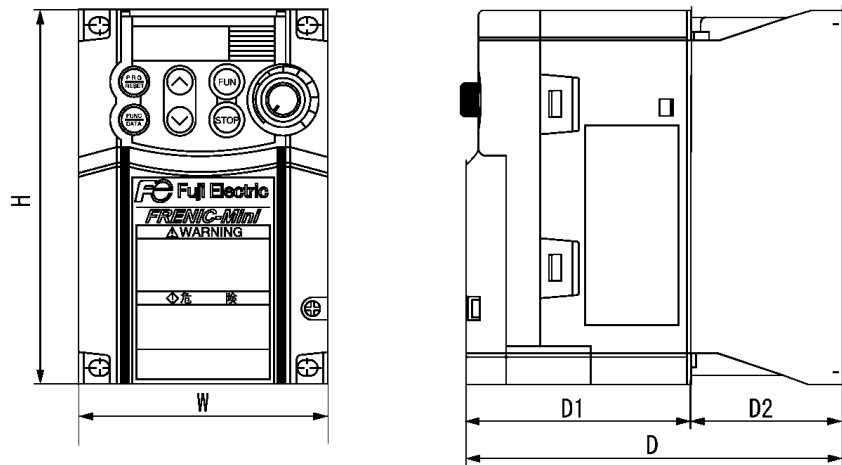



G.2.1 Standard models

**FVR-C9S vs. FRENIC-Mini**

		FVR-C9S (IP20) (Ambient temperature: 50°C)									FRENIC-Mini (IP20) (Ambient temperature: 50°C)						
Power supply voltage	Applicable motor rating (kW)	External dimensions (mm)					Mounting area		Volume		External dimensions (mm)					Mounting area	Volume
		W	H	D	D1	D2	m <sup>2</sup> (x10 <sup>-2</sup> )	/Mini (%)	m <sup>3</sup> (x10 <sup>-3</sup> )	/Mini (%)	W	H	D	D1	D2	m <sup>2</sup> (x10 <sup>-2</sup> )	m <sup>3</sup> (x10 <sup>-3</sup> )
3-phase 200 V	0.1	80	120	<b>60</b>	<b>50</b>	10	1.0	100.0	0.6	<b>75.0</b>	80	120	80	70	10	1.0	0.8
	0.2	80	120	<b>65</b>	<b>50</b>	15	1.0	100.0	0.6	<b>81.3</b>	80	120	80	70	10	1.0	0.8
	0.4	80	120	<b>75</b>	<b>50</b>	25	1.0	100.0	0.7	<b>78.9</b>	80	120	95	70	25	1.0	0.9
	0.75	80	120	<b>100</b>	<b>50</b>	50	1.0	100.0	1.0	<b>83.3</b>	80	120	120	70	50	1.0	1.2
	1.5	110	130	<b>130</b>	<b>65</b>	65	1.4	100.0	1.9	<b>93.5</b>	110	130	139	75	64	1.4	2.0
	2.2	110	130	<b>140</b>	75	65	1.4	100.0	2.0	100.7	110	130	139	75	64	1.4	2.0
	3.7, 4.0	140	180	<b>138</b>	<b>65</b>	73	2.5	100.0	3.5	<b>99.3</b>	140	180	139	75	64	2.5	3.5
3-phase 400 V	0.4	-	-	-	-	-	-	-	-	-	110	130	115	75	40	1.4	1.6
	0.75	-	-	-	-	-	-	-	-	-	110	130	139	75	64	1.4	2.0
	1.5	-	-	-	-	-	-	-	-	-	110	130	139	75	64	1.4	2.0
	2.2	-	-	-	-	-	-	-	-	-	110	130	139	75	64	1.4	2.0
	3.7, 4.0	-	-	-	-	-	-	-	-	-	140	180	139	75	64	2.5	3.5
1-phase 200 V	0.1	80	120	85.5	75.5	10	1.0	100.0	0.8	106.9	80	120	80	70	10	1.0	0.8
	0.2	80	120	90.5	75.5	15	1.0	100.0	0.9	113.1	80	120	80	70	10	1.0	0.8
	0.4	80	120	100.5	75.5	25	1.0	100.0	1.0	105.8	80	120	95	70	25	1.0	0.9
	0.75	80	120	140.5	90.5	50	1.0	100.0	1.3	100.4	80	120	140	90	50	1.0	1.3
	1.5	110	130	<b>140.5</b>	<b>75.5</b>	65	1.4	100.0	2.0	<b>94.3</b>	110	130	149	85	64	1.4	2.1
	2.2	-	-	-	-	-	-	-	-	-	140	180	139	75	64	2.5	3.5

**FVR-C11S vs. FRENIC-Mini**

		FVR-C11S (IP20) (Ambient temperature: 50°C)									FRENIC-Mini (IP20) (Ambient temperature: 50°C)						
Power supply voltage	Applicable motor rating (kW)	External dimensions (mm)					Mounting area		Volume		External dimensions (mm)					Mounting area	Volume
		W	H	D	D1	D2	m <sup>2</sup> (x10 <sup>-2</sup> )	/Mini (%)	m <sup>3</sup> (x10 <sup>-3</sup> )	/Mini (%)	W	H	D	D1	D2	m <sup>2</sup> (x10 <sup>-2</sup> )	m <sup>3</sup> (x10 <sup>-3</sup> )
3-phase 200 V	0.1	80	120	80	70	10	1.0	100.0	0.8	100.0	80	120	80	70	10	1.0	0.8
	0.2	80	120	85	70	15	1.0	100.0	0.8	106.3	80	120	80	70	10	1.0	0.8
	0.4	80	120	95	70	25	1.0	100.0	0.9	100.0	80	120	95	70	25	1.0	0.9
	0.75	80	120	120	70	50	1.0	100.0	1.2	100.0	80	120	120	70	50	1.0	1.2
	1.5	110	130	139	75	64	1.4	100.0	2.0	100.0	110	130	139	75	64	1.4	2.0
	2.2	110	130	139	75	64	1.4	100.0	2.0	100.0	110	130	139	75	64	1.4	2.0
	3.7, 4.0	140	180	<b>137</b>	65	72	2.5	100.0	3.5	<b>98.6</b>	140	180	139	75	64	2.5	3.5
3-phase 400 V	0.4	-	-	-	-	-	-	-	-	-	110	130	115	75	40	1.4	1.6
	0.75	-	-	-	-	-	-	-	-	-	110	130	139	75	64	1.4	2.0
	1.5	-	-	-	-	-	-	-	-	-	110	130	139	75	64	1.4	2.0
	2.2	-	-	-	-	-	-	-	-	-	110	130	139	75	64	1.4	2.0
	3.7, 4.0	-	-	-	-	-	-	-	-	-	140	180	139	75	64	2.5	3.5
1-phase 200 V	0.1	80	120	80	70	10	1.0	100.0	0.8	100.0	80	120	80	70	10	1.0	0.8
	0.2	80	120	85	70	15	1.0	100.0	0.8	106.3	80	120	80	70	10	1.0	0.8
	0.4	80	120	115	90	25	1.0	100.0	1.1	121.1	80	120	95	70	25	1.0	0.9
	0.75	80	120	140	90	50	1.0	100.0	1.3	100.0	80	120	140	90	50	1.0	1.3
	1.5	110	130	149	85	64	1.4	100.0	2.1	100.0	110	130	149	85	64	1.4	2.1
	2.2	140	180	<b>137</b>	<b>65</b>	72	2.5	100.0	3.5	<b>98.6</b>	140	180	139	75	64	2.5	3.5

App.

## G.2.2 RS-485 communication support models

### FVR-C11S vs. FRENIC-Mini

		FVR-C11S (IP20) with RS-485 communications card (option) mounted (Ambient temperature: 50°C)									FRENIC-Mini (IP20) (Ambient temperature: 50°C)						
		External dimensions (mm)					Mounting area		Volume		External dimensions (mm)					Mounting area	Volume
		W	H	D	D1	D2	m <sup>2</sup> (x10 <sup>-2</sup> )	/Mini (%)	m <sup>3</sup> (x10 <sup>-3</sup> )	/Mini (%)	W	H	D	D1	D2	m <sup>2</sup> (x10 <sup>-2</sup> )	m <sup>3</sup> (x10 <sup>-3</sup> )
3-phase 200 V	0.1	80	120	90	80	10	1.0	100.0	0.9	112.5	80	120	80	70	10	1.0	0.8
	0.2	80	120	95	80	15	1.0	100.0	0.9	118.8	80	120	80	70	10	1.0	0.8
	0.4	80	120	105	80	25	1.0	100.0	1.0	110.5	80	120	95	70	25	1.0	0.9
	0.75	80	120	130	80	50	1.0	100.0	1.2	108.3	80	120	120	70	50	1.0	1.2
	1.5	110	130	149	85	64	1.4	100.0	2.1	107.2	110	130	139	75	64	1.4	2.0
	2.2	110	130	149	85	64	1.4	100.0	2.1	107.2	110	130	139	75	64	1.4	2.0
	3.7	140	180	147	75	72	2.5	100.0	3.7	105.8	140	180	139	75	64	2.5	3.5
3-phase 400 V	0.4	-	-	-	-	-	-	-	-	-	110	130	115	75	40	1.4	1.6
	0.75	-	-	-	-	-	-	-	-	-	110	130	139	75	64	1.4	2.0
	1.5	-	-	-	-	-	-	-	-	-	110	130	139	75	64	1.4	2.0
	2.2	-	-	-	-	-	-	-	-	-	110	130	139	75	64	1.4	2.0
	3.7	-	-	-	-	-	-	-	-	-	140	180	139	75	64	2.5	3.5
1-phase 200 V	0.1	80	120	90	80	10	1.0	100.0	0.9	112.5	80	120	80	70	10	1.0	0.8
	0.2	80	120	95	80	15	1.0	100.0	0.9	118.8	80	120	80	70	10	1.0	0.8
	0.4	80	120	125	100	25	1.0	100.0	1.2	131.6	80	120	95	70	25	1.0	0.9
	0.75	80	120	150	100	50	1.0	100.0	1.4	107.1	80	120	140	90	50	1.0	1.3
	1.5	110	130	159	95	64	1.4	100.0	2.3	106.7	110	130	149	85	64	1.4	2.1
	2.2	140	180	147	75	72	2.5	100.0	3.7	105.8	140	180	139	75	64	2.5	3.5

### G.3 Terminal arrangements and symbols

This section shows the difference in the terminal arrangements and their symbols between the FRENIC-Mini series and the replaceable inverter series.

When replacing the conventional series with the FRENIC-Mini series, be careful with the wiring direction that may also differ depending upon models

#### FVR-C9S vs. FRENIC-Mini

##### FVR-C9S

Three-phase 200V 0.1 to 3.7 kW

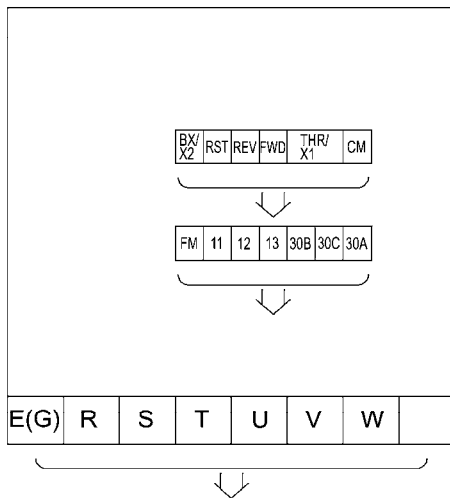

##### FRENIC-Mini

Three-phase 200V 0.1 to 0.75 kW

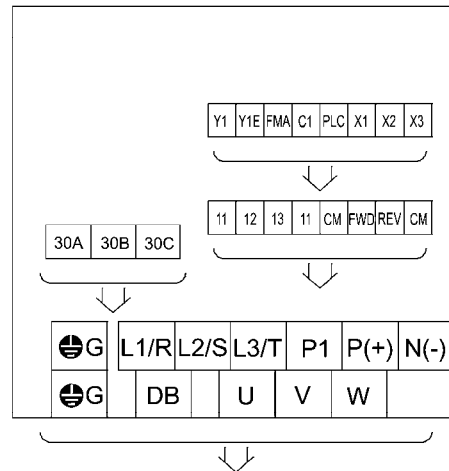

Three-phase 200V 1.5 to 3.7 (4.0) kW

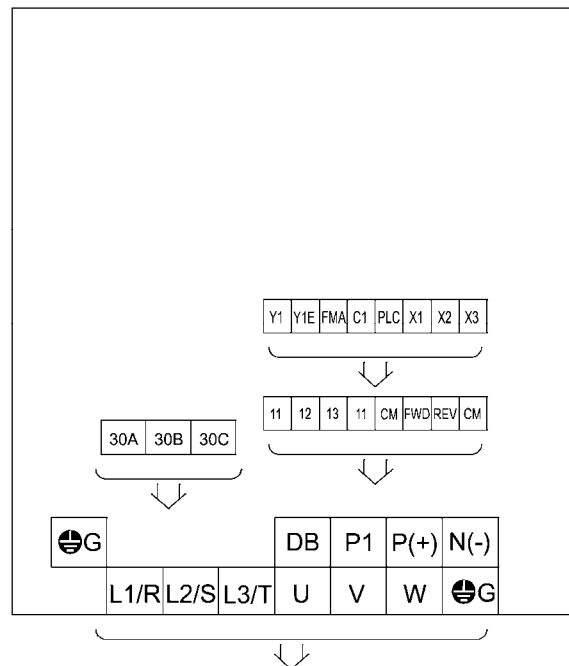

⇓ : Direction of wire guide

App.

## FVR-C11S vs. FRENIC-Mini

### FVR-C11S

Three-phase 200 V 0.1 to 3.7 kW

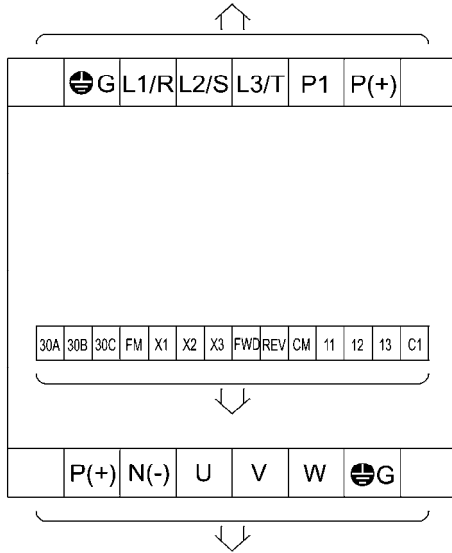

### FRENIC-Mini

Three-phase 200 V 0.1 to 0.75 kW

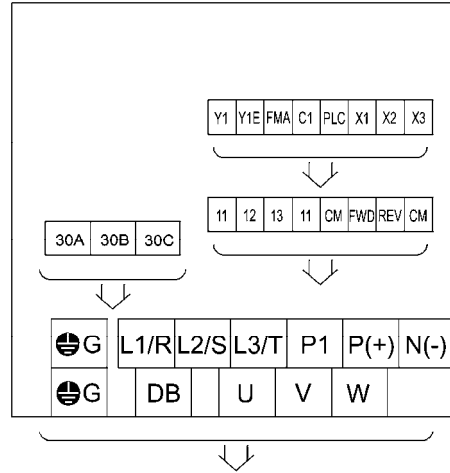

Three-phase 200 V 1.5 to 3.7 (4.0) kW

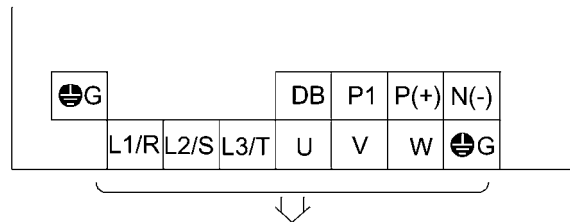

Single-phase 200 V 0.1 to 2.2 kW

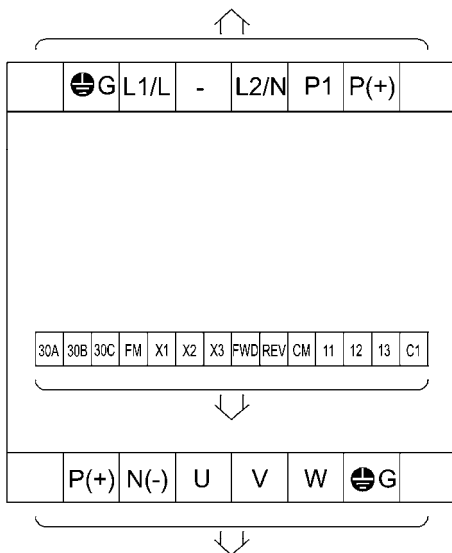

Single-phase 200 V 0.1 to 0.75 kW

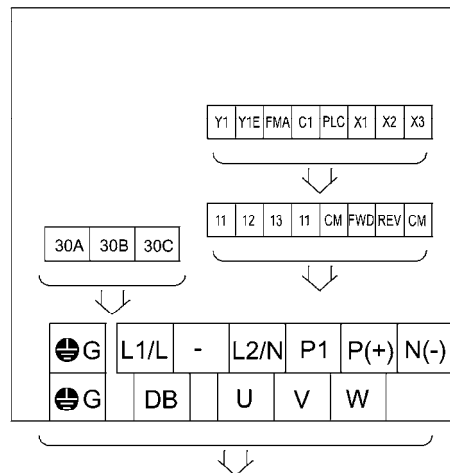

Single-phase 200 V 1.5, 2.2 kW

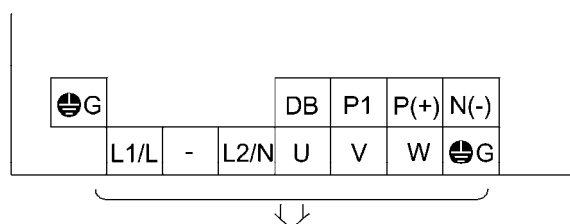

↑ ↓ : Direction of wire guide

## G.4 Function codes

This section describes the replacement information related to function codes that are required when replacing the conventional inverter series (e.g., FVR-C9S and FVR-C11S) with the FRENIC-Mini series. It also provides the conversion table for the torque boost setting.

### FVR-C9S vs. FRENIC-Mini

FVR-C9S		FRENIC-Mini		Remarks
Function code	Name	Function code	Name	
F00	Data protection	F00	Data Protection	
F01	Frequency command	F01	Frequency Command Source 1	
F02	Operation method	F02	RUN Command Source	
F03	Maximum frequency	F03	Maximum Frequency	
F04	Base frequency	F04	Base Frequency	
F05	Acceleration time	F07	Acceleration Time 1	
F06	Deceleration time	F08	Deceleration Time 1	
F07	Torque boost	F09	Torque Boost	The data implements other function. For details, refer to the torque boost setting conversion table on page A-33.
		F37	Load Selection/Auto Torque Boost/Auto Energy Saving Operation	Select the reduced/constant torque using F37.
F08	Electronic thermal overload relay (Select)	F10	Electronic Thermal Motor Overload Protection (Select motor characteristics)	Select "Disable" using F11 (= 0.00) instead of F10.
F09	Electronic thermal overload relay (Level)	F11	Electronic Thermal Motor Overload Protection (Overload detection current)	
		F12	Electronic Thermal Motor Overload Protection (Thermal time constant)	Set the data at 1.0min.
F10	Restart mode after momentary power failure (Select)	F14	Restart after Instantaneous Power Failure	F10=0/F10=1 is equivalent to F14=1/F14=4.
F11	Frequency setting gain	C32	Analog Input Adjustment (Gain for terminal input [12]) (Gain)	Analog input is applied to [12] so that the gain for set frequency is equal to the gain for [12]. Setting differs each other. Refer to Chapter 9 "FUNCTION CODES" for details.
		C34	Analog Input Adjustment (Gain for terminal input [12]) (Gain reference point)	
F26	Bias frequency	F18	Bias (for Frequency Command 1, F01)	
		C50	Bias (Frequency command 1) (Bias reference point)	
F12	DC brake (Braking current)	F21	DC Braking (Braking level)	
F13	DC brake (Braking time)	F22	DC Braking (Braking time)	
		F20	DC Braking (Start frequency)	Set at 3 Hz.
F14	Starting frequency	F23	Start Frequency	
F15	Motor sound	F26	Motor Sound (Carrier frequency)	F15=0 to 5 sets the carrier frequency at 2.5 to 15kHz equivalently. Check the motor sound and select the frequency correctly.
F16	Alarm history			Check the alarm information from the keypad. Refer to Chapter 3 for details.
F17	Data initializing	H03	Data Initialization (Data reset)	
F18	Auto-reset	H04	Retry (No. of retries)	When the retry is enabled (F18=1), set H04=5/H05=0.5s.
		H05	Retry (Latency time)	
F19	Motor Characteristics			No function code with same feature. No setting required.
F20	Jump frequency width	C04	Jump Frequency Band	
F21	Jump frequency 1	C01	Jump Frequency 1	
F22	Jump frequency 2	C02	Jump Frequency 2	
F23	Jump frequency 3	C03	Jump Frequency 3	
F24	Peak frequency	F15	Frequency Limiter (High)	
F25	Bottom frequency	F16	Frequency Limiter (Low)	
F27	THR terminal function	E01	X1 Terminal Function	Assign (THR) to the terminal [X1]. If F27=0, set E01=9, if F27=1, set E01=0.
F28	BX terminal function	E02	X2 Terminal Function	Assign (BX) to the terminal [X2]. If F28=0, set E02=7, if F28=1, set E02=1.
F29	Multistep frequency setting 1	C05	Multistep Frequency Settings 1	
F30	Multistep frequency setting 2	C06	Multistep Frequency Settings 2	
F31	Multistep frequency setting 3	C07	Multistep Frequency Settings 3	
F32	FM terminal (Voltage adjustment)	F30	Terminal [FMA] (Gain to output voltage)	The data has different feature each other. Readjust the meter.
F33	FM terminal (Select)	F31	Terminal [FMA] (Monitor object)	When selecting the output frequency (F33=0), set F31=0. If the output current (F33=1), set F31=2.

## **FVR-C11S vs. FRENIC-Mini**

FVR-C11S		FRENIC-Mini		Remarks
Function code	Name	Function code	Name	
F00	Data protection	F00	Data Protection	
F01	Frequency command	F01	Frequency Command Source 1	
F02	Operation method	F02	RUN Command Source	
F03	Maximum frequency	F03	Maximum Frequency	
F04	Base frequency	F04	Base Frequency	
F07	Acceleration time	F07	Acceleration Time 1	
F08	Deceleration time	F08	Deceleration Time 1	
F09	Torque boost	F09	Torque Boost	The data implements other function. For details, refer to the torque boost setting conversion table on page A-33.
		F37	Load Selection/Auto Torque Boost/Auto Energy Saving Operation	Select the reduced/constant torque using F37.
F10	Electronic thermal overload relay (Select)	F10	Electronic Thermal Motor Overload Protection (Select motor characteristics)	Select "Disable" using F11 (= 0.00) instead of F10.
F11	Electronic thermal overload relay (Level)	F11	Electronic Thermal Motor Overload Protection (Overload detection current)	
F12	Electronic thermal overload relay	F12	Electronic Thermal Motor Overload Protection (Thermal time constant)	
F14	Restart mode after momentary power failure (Select)	F14	Restart after Instantaneous Power Failure	Replace the data of FVR-C11S from 2 to 4 of FRENIC-Mini and from 3 to 5.
F15	Frequency limiter (Peak)	F15	Frequency Limiter (High)	
F16	Frequency limiter (Bottom)	F16	Frequency Limiter (Low)	
F17	Gain (Frequency setting)	C32	Analog Input Adjustment (Gain for terminal input [12]) (Gain)	Analog input is applied to [12] so that the gain for set frequency is equal to the gain for [12]. Setting differs each other. Refer to Chapter 9 "FUNCTION CODES" for details.
		C34	Analog Input Adjustment (Gain for terminal input [12]) (Gain reference point)	
F18	Bias frequency	F18	Bias (for Frequency Command 1, F01)	
		C50	Bias (Frequency command 1) (Bias reference point)	
F20	DC brake (Starting freq.)	F20	DC Braking (Start frequency)	Set at 3 Hz.
F21	DC brake (Braking level)	F21	DC Braking (Braking level)	
F22	DC brake (Braking time)	F22	DC Braking (Braking time)	
F23	Starting frequency	F23	Start Frequency	
F25	Stop frequency	F25	Stop Frequency	
F26	Motor sound (Carrier freq.)	F26	Motor Sound (Carrier frequency)	
F27	Motor sound (Sound tone)	F27	Motor Sound (Sound tone)	
F30	FM terminal (Voltage adjustment)	F30	Terminal [FMA] (Gain to output voltage)	
F31	FM terminal (Select)	F31	Terminal [FMA] (Monitor object)	The selection for the data differs each other. For details refer to Chapter 9 "FUNCTION CODES."
F36	30Ry operation mode	E27	[30A/B/C] Terminal Function (Mechanical relay contacts)	If F36=0, set E27=99, if F36=1, set E27=1099.
E01	X1 terminal function (Select)	E01	X1 Terminal Function	The selection for the data differs each other. For details refer to Chapter 9 "FUNCTION CODES."
E02	X2 terminal function (Select)	E02	X2 Terminal Function	
E03	X3 terminal function (Select)	E03	X3 Terminal Function	
C01	Jump frequency 1	C01	Jump Frequency 1	
C02	Jump frequency 2	C02	Jump Frequency 2	
C03	Jump frequency 3	C03	Jump Frequency 3	
C04	Jump frequency (Hysteresis)	C04	Jump Frequency Band	
C05	Multistep frequency setting 1	C05	Multistep Frequency Settings 1	
C06	Multistep frequency setting 2	C06	Multistep Frequency Settings 2	
C07	Multistep frequency setting 3	C07	Multistep Frequency Settings 3	
P00	Motor Characteristics			No function code with same feature. No setting required.
H01	Operation time			Check the alarm information from the keypad. Refer to Chapter 3 for details.
H02	Trip history			Check the alarm information from the keypad. Refer to Chapter 3 for details.
H03	Data initializing	H03	Data Initialization (Data reset)	
H04	Auto-reset (Times)	H04	Retry (No. of retries)	If the retry is disabled, set 0. If enabled, set 5times.
		H05	Retry (Latency time)	

FVR-C11S		FRENIC-Mini		Remarks
Function code	Name	Function code	Name	
H06	Fan stop operation	H06	Cooling Fan ON/OFF	
H20	PID control (Select)	J01	PID Control	
H21	PID control (Feedback signal select)	E61	Terminal [12] (Function selection)	To select the [12] as the feedback set the data of 5.
		E62	Terminal [C1](Function selection)	To select the [C1] as the feedback set the data of 5.
		C32	Analog Input Adjustment (Gain for terminal input [12]) (Gain)	When the frequency is commanded in 1-5V, select the [12] and set the C32 (analog input gain) for 200%. Use it as 0-5V range.
H22	PID control P (gain)	J03	PID control P (gain)	
H23	PID control I (Integration time)	J04	PID control I (Integration time)	
H24	PID control D (Differentiation time)	J05	PID control D (Differentiation time)	
H25	PID control (Feedback filter)	J06	PID control (Feedback filter)	
o00	Option select (RS485)	y10	RS485 (Protocol selection)	Select 2 (Fuji general-purpose protocol).
o01	Station address	y01	RS485 (Station address)	
o02	Mode select on no response error	y02	RS485 (Mode selection on no response error)	
o03	Timer	y03	RS485 (Timer)	
o04	Baud rate	y04	RS485 (Transmission speed)	1200 bps is not supported.
o05	Data length	y05	RS485 (Data length)	
o06	Parity check	y06	RS485 (Parity check)	
o07	Stop bits	y07	RS485 (Stop bits)	
o08	No response error detection time	y08	RS485 (No response error detection time)	
o09	Response interval	y09	RS485 (Response interval)	
o10	RS485 command select (Frequency setting)	H30	Communications Link (Function selection)	For details of the data compatibility, refer to Chapter 9 "FUNCTION CODES."
o11	RS485 command select (Running command)			

**Conversion Table for Setting Torque Boost**

Inverter Series Name	FVR-C9S	FRENIC-Mini	
	FVR-C11S	F09	F37
Data	F09	F09	F37
	0	0	0
	1	None, Consult us.	
	2	0	1
	3	0.2	1
	4	0.8	1
	5	1.5	1
	6	2.3	1
	7	3.1	1
	8	3.9	1
	9	4.7	1
	10	5.5	1
	11	6.3	1
	12	7.2	1
	13	8	1
	14	8.9	1
	15	9.8	1
	16	10.6	1
	17	11.5	1
	18	12.5	1
	19	13.2	1
	20	14.1	1
	21	15	1
	22	15.8	1
	23	16.7	1
	24	17.5	1
	25	18.3	1
	26	19.2	1
	27	20	1
	28	20	1
	29	20	1
30	20	1	
31	20	1	

App.





**Compact Inverter**  
***FRENIC-Mini***

---

**User's Manual**

First Edition, March 2013  
Third Edition, April 2014

Fuji Electric Co., Ltd.

---

The purpose of this manual is to provide accurate information in the handling, setting up and operating of the FRENIC-Mini series of inverters. Please feel free to send your comments regarding any errors or omissions you may have found, or any suggestions you may have for generally improving the manual.

In no event will Fuji Electric Co., Ltd. be liable for any direct or indirect damages resulting from the application of the information in this manual.

---

** Fuji Electric Co., Ltd.**

Gate City Ohsaki, East Tower, 11-2, Osaki 1-chome, Shinagawa-ku, Tokyo 141-0032, Japan  
Phone : (03)5435-7111

---

Internet address : <http://www.fujielectric.co.jp>

Information in this manual is subject to change without notice.

2014-04