

NOTES:

△HOOK ACCEPTS P.C.B. THICKNESS 1.57±0.08[.062±.003]

2. SPECIFICATION:

- 2-1.ELECTRICAL CHARACTERISTICS:
- 2-1-1.CONTACT CURRENT RATING: 3 AMPERES .
 - 2-1-2.CONTACT RESISTANCE: 35 milliohms(MAX.).
 - 2-1-3.INSULATION RESISTANCE: 5000 Megohms (MIN).
 - 2-1-4.DIELECTRIC WITHSTANDING VOLTAGE:1000 VAC (MIN). AT SEA LEVEL.

2-2.MECHANICAL CHARACERISTICS

- 2-2-1.CONTACT ENGAGEMENT FORCE: 0.340kgf(MAX.).
- 2-2-2.CONTACT SEPARATION FORCE: 0.021kgf(MIN.).
- 2-2-3.CONTACT RETENTION FORCE: 0.91kgf(MIN.).
- 2-2-4.BURABILITY: 500 CYCLES.

2-3.ENVIRONMENT CHARACTERISTICS:

- 2-3-1.OPERATING TEMPERATURE:-55 °C TO +105 °C
- 2-3-2. " RoHS" COMPLIANT.

PRODUCT NO.: DT 0 1 3 1 * - F*A* - 4F

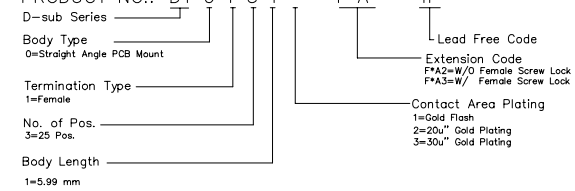

ITEM	DESC.	Q'TY	MATERIAL	TREATMENT	REMARK
6	FEMALE SCREW LOCK	2	BRASS	NICKEL PLATED	FOR TYPE II
5	BOARD LOCK	2	PHOSPHOR BRONZE	TIN PLATED	
4	CLINCH NUT	2	BRASS	NICKEL PLATED	
3	CONTACT	25	PHOSPHOR BRONZE	GOLD PLATING AT CONTACT AREA, 100-200u" Sn ALLOY (LEAD FREE) AT TAIL, OVER 50u" NICKEL OVERALL.	
2	HOUSING	1	THERMOPLASTIC UL 94V-0	MOLDED COLOR BLACK MOLDED PANTONE 235C	FOR DT0131*-F4A*-4F FOR DT0131*-F5A*-4F
1	SHELL	1	STEEL	TIN PLATED	

X.±	X*±	UNITS	MM[INCH]	NAME(INTENDED USE)	FOXCONN HON HAI PRECISION IND. CO.,LTD. TAIPEI, TAIWAN, R.O.C.
.X±	.X*±	MAT'L		CUSTOMER	
.XX±0.38[.015]	.XX*±		N/A	PART NO.(INTENDED USE)	TITLE: DT SERIES FEMALE LOW-PROFILE
.XXX±	.XXX*±	FINISH	N/A	APPD: Corel Zhu 6/25'06	DWG NO.: 301-0000-1475
THESE DRAWINGS AND SPECIFICATIONS ARE THE PROPERTY OF HON HAI PRECISION IND. CO., LTD. AND SHALL NOT BE REPRODUCED, COPIED OR USED IN ANY MANNER WITHOUT THE PRIOR WRITTEN CONSENT OF HON HAI PRECISION IND. CO., LTD.				Q'TY	CHKD: X.H. Xiang 6/25'06
				DR: K.X. Jiang 6/25'06	SCALE SHEET REV. 1:1 1/1 A

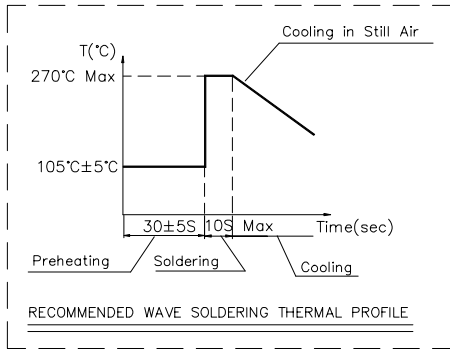
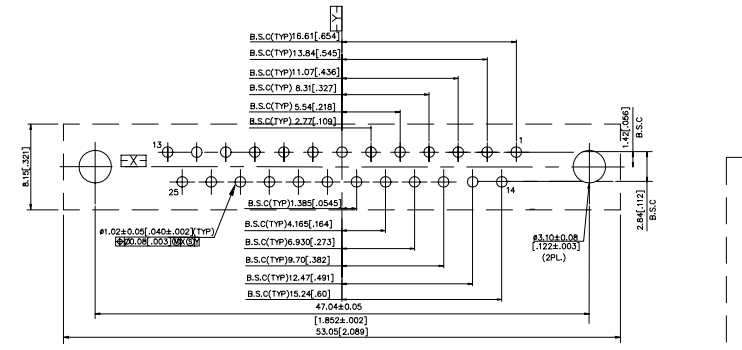
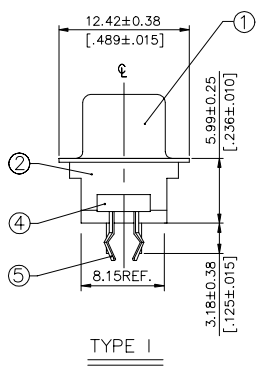
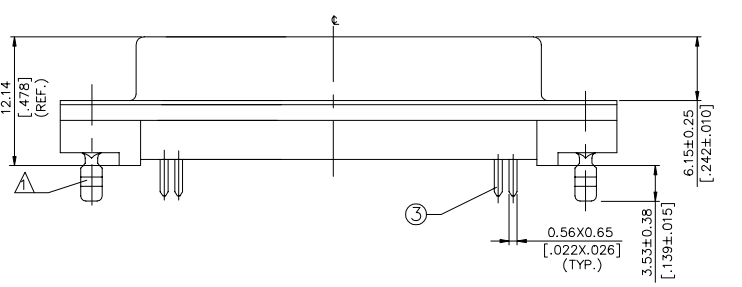
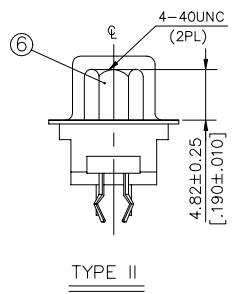
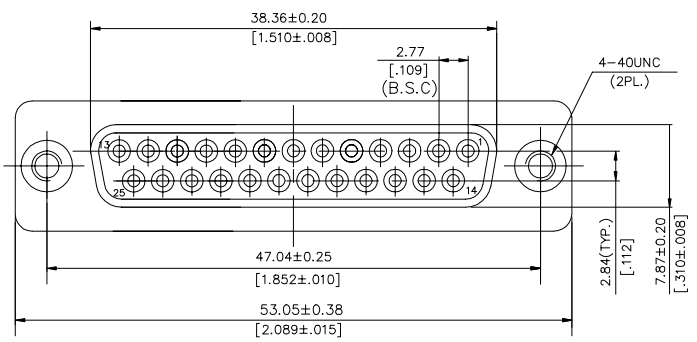

PART NO.	PLASTIC COLOR	TYPE	NOTES
DT0131*-F5A2-4F	PANTONE 235C	TYPE I	THE PRODUCT WITHOUT F.S.L LOCKED
DT0131*-F5A3-4F	PANTONE 235C	TYPE II	THE PRODUCT WITH F.S.L LOCKED
DT0131*-F4A2-4F	BLACK	TYPE I	THE PRODUCT WITHOUT F.S.L LOCKED
DT0131*-F4A3-4F	BLACK	TYPE II	THE PRODUCT WITH F.S.L LOCKED