

REV.	ECN. NO.	APPD.
A	BC-10-0041926	Rocky Su
B	BC-10-0044449	Rocky Su
C	BC-10-0153282	Rocky Su
D	BC-11-0047476	Achilles. Wang
E	BC-11-0048879	Achilles. Wang

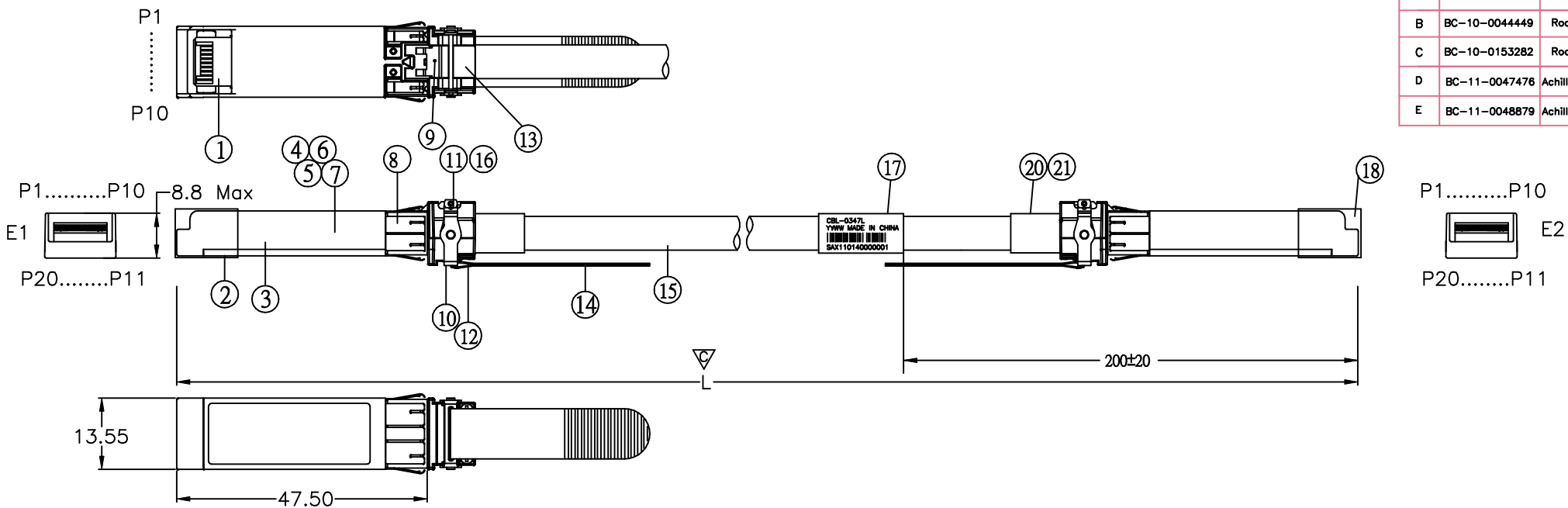

NOTES:

- ALL MATERIAL MUST COMPLY WITH FOXCONN ENG. SPEC. EPI12.
- DIMENSION MARKED ∇ SHOULD BE CHECKED.
- CABLE: 2 INDIVIDUAL SHIELDED PAIRS WITH DOUBLE SHIELDED OVERALL, JACKET COLOR: BLACK. DIFFERENTIAL IMPEDANCE: 100±5 Ohms.
- THE CAPACITANCE VALUE: 100±20nf.
- SAX111140000001
 - Serial Number
 - Week
 - Year
 - "X": FOXCONN "1": VERSION CODE
 - 2GSPWWA-05G-OF A
 - 2GSPWWB-06G-OF B
 - 2GSPWWC-07G-OF C
 - 2GSPWWB-08G-OF D
- THE ABOVE BARCODE INDICATES THE UPS CODE AND THE BELOW BARCODE INDICATES THE QUANTITY PER BAG.
- ALL THE BARCODES ARE PRINTED IN 128 CODE.

TABLE 1:

CUSTOMER P/N	FOXCONN P/N	DIMENSION "L"	WIRE AWG	WIRE CUTTING DIMENSION	COMMENT
CBL-0347L	2GSPWWA-05G-OF	L=1000±50	30AWG	1000±5	WITH SHRINK TUBE
CBL-0348L	2GSPWWB-06G-OF	L=3000±80	30AWG	3000±5	WITH SHRINK TUBE
CBL-0349L	2GSPWWC-07G-OF	L=5000±150	24AWG	5000±5	WITHOUT SHRINK TUBE
CBL-0456L	2GSPWWB-08G-OF	L=2000±50	30AWG	2000±5	WITH SHRINK TUBE

X± 3	X'±	UNITS mm	NAME (INTENDED USE)	FOXCONN HON HAI PRECISION IND. CO., LTD. TAIPEI, TAIWAN, R.O.C.
X± 0.3	X"±	MATL	Customer	
.XX± 0.20	.XX'±	FINISH	PART NO. (INTENDED USE)	TITLE: CABLE ASSEMBLY, PASSIVE COPPER SFP+
.XXX±	.XXX'±		SEE TABLE 1	APPD: Achilles. Wang 5/7'11
THESE DRAWINGS AND SPECIFICATIONS ARE THE PROPERTY OF HON HAI PRECISION IND. CO., LTD. AND SHALL NOT BE REPRODUCED, COPIED OR USED IN ANY MANNER WITHOUT THE PRIOR WRITTEN CONSENT OF HON HAI PRECISION IND. CO., LTD.			CHKD: Jun Chen 5/7'11	SCALE N/A SHEET 1/3 REV. E
			QTY	

REV.	ECN.	NO.	APPD.
------	------	-----	-------

Label on the Cable:

CBL-0347L
YYWW MADE IN CHINA

SAX111140000001

CBL-0348L
YYWW MADE IN CHINA

SBX111140000001

CBL-0349L
YYWW MADE IN CHINA

SCX111140000001

SEE NOTES 5

CBL-0456L
YYWW MADE IN CHINA

SDX111140000001

Label on the plastic bag:

CBL-0347L

672042062133
Qty:1

CBL-0348L

672042062140
Qty:1

CBL-0349L

672042062157
Qty:1

SEE NOTES 6

CBL-0456L

672042088652
Qty:1

CABLE CONNECTION:

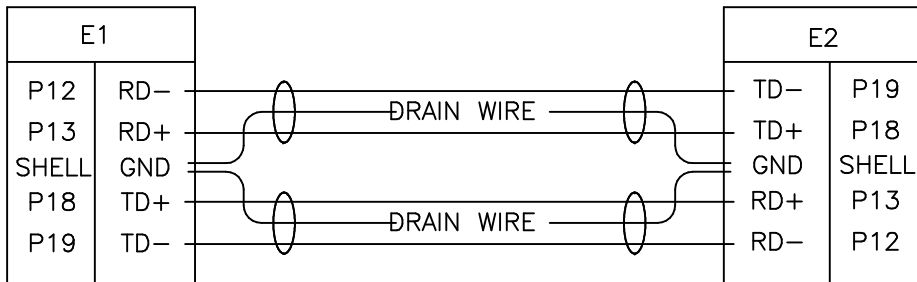

21	SHRINK TUBE	080-2008-620	BLACK	N/A
20	SHRINK TUBE	080-2007-620	BLACK	N/A
19	LABEL	086-0023-4348	WHITE	1PCS
18	Dust Cover	901-0108-008	WHITE	2PCS
17	LABEL	081-0028-664	WHITE	1PCS
16	WASHER	023-0002-599	WASHER	2PCS
15	RAW CABLE	791-1032-020	2 PAIR, 30AWG, 100 ohms	N/A
		791-7028-020	2 PAIR, 24AWG, 100 ohms	N/A
14	PULL LOOP	085-0001-4584	T=0.26mm BLACK	2PCS
13	PLASTIC RAMP	013-0004-2697	COLOR:BLACK	2PCS
12	SCREW-6.8mm	060-0001-2184	SCREW-6.8mm	4PCS
11	METAL PIN	023-0001-2167	METAL PIN	2PCS
10	ACTUATOR	023-1001-2149	ACTUATOR	2PCS
9	SPRING	024-0002-1349	SPRING	2PCS
8	EMI SHELL	023-0001-7720	EMI SHELL	2PCS
7	CONDUCTIVE TAPE	081-1105-875	CONDUCTIVE TAPE	N/A
6	HOT MELT GLUE	086-0001-1087	HOT MELT GLUE	0.008KG
5	OUTER RING	073-0033-2158	FOR 07G	2PCS
		073-0032-2158	FOR 05/06G/08G	2PCS
4	INNER RING	024-0006-2037	FOR 07G	2PCS
		024-0003-2037	FOR 05/06G/08G	2PCS
3	DIE-CAST BASE	023-3002-2148	DIE-CAST BASE	2PCS
2	DIE-CAST COVER	023-3002-2147	DIE-CAST COVER	2PCS
1	PCBA	2Q012AP01-600-G	FOR 05/06G/08G	2PCS
		2Q012HW01-600-G	FOR 07G	2PCS

NO	PART NAME	FOXCONN P/N	DESCRIPTION	QTY
X±	3	X±	UNITS mm	NAME(INTENDED USE) Customer
X±	0.3	X±	MATL	
.XX±	0.20	.XX±	FINISH	PART NO.(INTENDED USE) SEE TABLE 1
.XXX±		.XXX±		APPD: Achilles. Wang 5/7'11
THESE DRAWINGS AND SPECIFICATIONS ARE THE PROPERTY OF HON HAI PRECISION IND. CO., LTD. AND SHALL NOT BE REPRODUCED, COPIED OR USED IN ANY MANNER WITHOUT THE PRIOR WRITTEN CONSENT OF HON HAI PRECISION IND. CO., LTD.			QTY	CHKD: Jun Chen 5/7'11
			DR: Haidong Liu 5/7'11	TITLE: CABLE ASSEMBLY, PASSIVE COPPER SFP+
				DWG NO.: 603-0000-6389
				SCALE SHEET REV. N/A 2/3 E

PASSIVE SFP+ EEPROM

Address	Hex or ASCII	Description
0	03	SFP or SFP+
1	04	SFP function defined by two wire interface ID only
2	21	Copper Pigtail
3	01	1X copper Passive
4	00	
5	00	
6	04	1000Base-CX
7	41	Short distance,Electrical inter-enclosure
8	04	Passive cable
9	80	Twin Axial Pair
10	55	800MB,400MB,200MB,100MB
11	00	
12	67	10.3G
13	00	
14	00	
15	00	
16	00	
17	00	
18	1	Cable Length
19	00	
20...35	FOXCONN	Vendor Name
36	00	
37...39	00016C	Vendor OUI
40...55	2GSPWWA-05G-0F	FOXCONN PN
56...59	A	FOXCONN VER
60	00	
61	00	
62	00	
63		0 TO 62 CHECKSUM
64	00	
65	00	
66	00	
67	00	
68...83	SAX111140000001	FOXCONN SN
84...91	100406	DATE CODE

Address	Hex or ASCII	Description
92	00	
93	00	
94	00	
95		64 TO 94 CHECKSUM
96...127	00	
128...255	00	

REF To SFF8472 Rev10.4

REV.	ECN.	NO.	APPD.
------	------	-----	-------

X± 3	X±	UNITS mm	NAME(INTENDED USE) Customer	FOXCONN HON HAI PRECISION IND. CO.,LTD. TAIPEI, TAIWAN, R.O.C.
.XX± 0.20	.XX±	MATL	PART NO.(INTENDED USE) SEE TABLE 1	
.XXX±	.XXX±	FINISH	APPD: Achilles. Wang 5/7'11	TITLE: CABLE ASSEMBLY, PASSIVE COPPER SFP+
THESE DRAWINGS AND SPECIFICATIONS ARE THE PROPERTY OF HON HAI PRECISION IND. CO., LTD. AND SHALL NOT BE REPRODUCED, COPIED OR USED IN ANY MANNER WITHOUT THE PRIOR WRITTEN CONSENT OF HON HAI PRECISION IND. CO., LTD.			QTY	DWG NO.: 603-0000-6389
			CHKD: Jun Chen 5/7'11	 SCALE SHEET REV. N/A 3/3 E
			DR: Haidong Liu 5/7'11	