

Fast IGBT in NPT-technology with soft, fast recovery anti-parallel EmCon diode

- 75% lower E_{off} compared to previous generation combined with low conduction losses
- Short circuit withstand time – 10 μ s
- Designed for: Motor controls, Inverter
- NPT-Technology for 600V applications offers:
 - very tight parameter distribution
 - high ruggedness, temperature stable behaviour
 - parallel switching capability
- Very soft, fast recovery anti-parallel EmCon diode
- Isolated TO-220, 2.5kV, 60s
- Pb-free lead plating; RoHS compliant
- Qualified according to JEDEC¹ for target applications
- Complete product spectrum and PSpice Models : <http://www.infineon.com/igbt/>

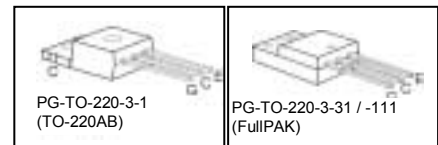
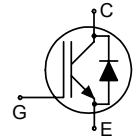

Type	V_{CE}	I_C	$V_{CE(sat)}$	T_j	Marking	Package
SKP06N60	600V	6A	2.3V	150°C	K06N60	PG-TO-220-3-1
SKA06N60	600V	5A	2.3V	150°C	K06N60	PG-TO-220-3-31 / -111

Maximum Ratings

Parameter	Symbol	Value		Unit
		SKP06N60	SKA06N60	
Collector-emitter voltage	V_{CE}	600	600	V
DC collector current	I_C			A
$T_C = 25^\circ\text{C}$		12	9	
$T_C = 100^\circ\text{C}$		6.9	5.0	
Pulsed collector current, t_p limited by T_{jmax}	I_{Cpuls}	24	24	
Turn off safe operating area $V_{CE} \leq 600\text{V}$, $T_j \leq 150^\circ\text{C}$	-	24	24	
Diode forward current	I_F			
$T_C = 25^\circ\text{C}$		12	12	
$T_C = 100^\circ\text{C}$		6	6	
Diode pulsed current, t_p limited by T_{jmax}	I_{Fpuls}	24	24	
Gate-emitter voltage	V_{GE}	± 20	± 20	V
Short circuit withstand time ²	t_{SC}			μ s
$V_{GE} = 15\text{V}$, $V_{CC} \leq 600\text{V}$, $T_j \leq 150^\circ\text{C}$		10	10	
Power dissipation	P_{tot}			W
$T_C = 25^\circ\text{C}$		68	32	
Mounting Torque, Screw: M2.5 (Fullpak), M3 (TO220) ³	M	0.6	0.5	Nm
Operating junction and storage temperature	T_j, T_{stg}	-55...+150	-55...+150	°C
Soldering temperature	T_s	260	260	°C
wavesoldering, 1.6 mm (0.063 in.) from case for 10s				

¹ J-STD-020 and JESD-022

² Allowed number of short circuits: <1000; time between short circuits: >1s.

³ Maximum mounting processes: 3

Thermal Resistance

Parameter	Symbol	Conditions	Max. Value		Unit
			SKP06N60	SKA06N60	
Characteristic					
IGBT thermal resistance, junction – case	R_{thJC}		1.85	3.9	K/W
Diode thermal resistance, junction – case	R_{thJCD}		3.5	5.0	
Thermal resistance, junction – ambient	R_{thJA}	PG-TO-220-3-1 PG-TO220-3-31 /-111	62	65	

Electrical Characteristic, at $T_j = 25^\circ\text{C}$, unless otherwise specified

Parameter	Symbol	Conditions	Value			Unit
			min.	Typ.	max.	
Static Characteristic						
Collector-emitter breakdown voltage	$V_{(BR)CES}$	$V_{GE}=0V, I_C=500\mu A$	600	-	-	V
Collector-emitter saturation voltage	$V_{CE(sat)}$	$V_{GE} = 15V, I_C=6A$ $T_j=25^\circ\text{C}$ $T_j=150^\circ\text{C}$	1.7 -	2.0 2.3	2.4 2.8	
Diode forward voltage	V_F	$V_{GE}=0V, I_F=6A$ $T_j=25^\circ\text{C}$ $T_j=150^\circ\text{C}$	1.2 -	1.4 1.25	1.8 1.65	
Gate-emitter threshold voltage	$V_{GE(th)}$	$I_C=250\mu A, V_{CE}=V_{GE}$	3	4	5	
Zero gate voltage collector current	I_{CES}	$V_{CE}=600V, V_{GE}=0V$ $T_j=25^\circ\text{C}$ $T_j=150^\circ\text{C}$	- -	- -	20 700	μA
Gate-emitter leakage current	I_{GES}	$V_{CE}=0V, V_{GE}=20V$	-	-	100	
Transconductance	g_{fs}	$V_{CE}=20V, I_C=6A$	-	4.2	-	S
Dynamic Characteristic						
Input capacitance	C_{iss}	$V_{CE}=25V,$ $V_{GE}=0V,$ $f=1\text{MHz}$	-	350	420	pF
Output capacitance	C_{oss}		-	38	46	
Reverse transfer capacitance	C_{riss}		-	23	28	
Gate charge	Q_{Gate}	$V_{CC}=480V, I_C=6A$ $V_{GE}=15V$	-	32	42	nC
Internal emitter inductance measured 5mm (0.197 in.) from case	L_E		-	7	-	nH
Short circuit collector current ²⁾	$I_{C(SC)}$	$V_{GE}=15V, t_{SC}\leq 10\mu s$ $V_{CC}\leq 600V,$ $T_j\leq 150^\circ\text{C}$	-	60	-	A

²⁾ Allowed number of short circuits: <1000; time between short circuits: >1s.

Switching Characteristic, Inductive Load, at $T_j=25^\circ\text{C}$

Parameter	Symbol	Conditions	Value			Unit
			min.	typ.	max.	
IGBT Characteristic						
Turn-on delay time	$t_{d(on)}$	$T_j=25^\circ\text{C}$, $V_{CC}=400\text{V}$, $I_C=6\text{A}$, $V_{GE}=0/15\text{V}$, $R_G=50\Omega$, $L_{\sigma}^{1)}=180\text{nH}$, $C_{\sigma}^{1)}=250\text{pF}$ Energy losses include "tail" and diode reverse recovery.	-	25	30	ns
Rise time	t_r		-	18	22	
Turn-off delay time	$t_{d(off)}$		-	220	264	
Fall time	t_f		-	54	65	
Turn-on energy	E_{on}		-	0.110	0.127	mJ
Turn-off energy	E_{off}		-	0.105	0.137	
Total switching energy	E_{ts}		-	0.215	0.263	
Anti-Parallel Diode Characteristic						
Diode reverse recovery time	t_{rr}	$T_j=25^\circ\text{C}$, $V_R=200\text{V}$, $I_F=6\text{A}$, $di_F/dt=200\text{A}/\mu\text{s}$	-	200	-	ns
	t_s		-	17	-	
	t_F		-	183	-	
Diode reverse recovery charge	Q_{rr}		-	200	-	nC
Diode peak reverse recovery current	I_{rrm}		-	2.8	-	A
Diode peak rate of fall of reverse recovery current during t_b	di_{rr}/dt		-	180	-	$\text{A}/\mu\text{s}$

Switching Characteristic, Inductive Load, at $T_j=150^\circ\text{C}$

Parameter	Symbol	Conditions	Value			Unit
			min.	typ.	max.	
IGBT Characteristic						
Turn-on delay time	$t_{d(on)}$	$T_j=150^\circ\text{C}$ $V_{CC}=400\text{V}$, $I_C=6\text{A}$, $V_{GE}=0/15\text{V}$, $R_G=50\Omega$, $L_{\sigma}^{1)}=180\text{nH}$, $C_{\sigma}^{1)}=250\text{pF}$ Energy losses include "tail" and diode reverse recovery.	-	24	29	ns
Rise time	t_r		-	17	20	
Turn-off delay time	$t_{d(off)}$		-	248	298	
Fall time	t_f		-	70	84	
Turn-on energy	E_{on}		-	0.167	0.192	mJ
Turn-off energy	E_{off}		-	0.153	0.199	
Total switching energy	E_{ts}		-	0.320	0.391	
Anti-Parallel Diode Characteristic						
Diode reverse recovery time	t_{rr}	$T_j=150^\circ\text{C}$ $V_R=200\text{V}$, $I_F=6\text{A}$, $di_F/dt=200\text{A}/\mu\text{s}$	-	290	-	ns
	t_s		-	27	-	
	t_F		-	263	-	
Diode reverse recovery charge	Q_{rr}		-	500	-	nC
Diode peak reverse recovery current	I_{rrm}		-	5.0	-	A
Diode peak rate of fall of reverse recovery current during t_b	di_{rr}/dt		-	200	-	$\text{A}/\mu\text{s}$

¹⁾ Leakage inductance L_{σ} and Stray capacity C_{σ} due to dynamic test circuit in Figure E.

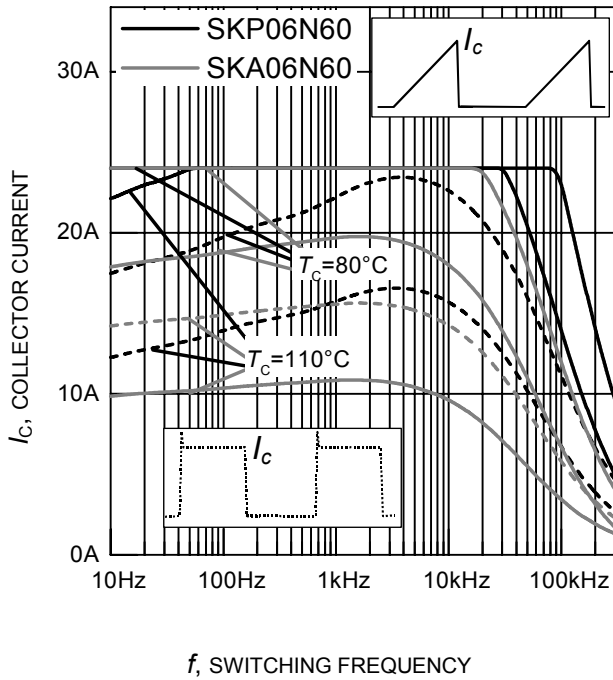

Figure 1. Collector current as a function of switching frequency
 ($T_j \leq 150^\circ\text{C}$, $D = 0.5$, $V_{CE} = 400\text{V}$,
 $V_{GE} = 0/+15\text{V}$, $R_G = 50\Omega$)

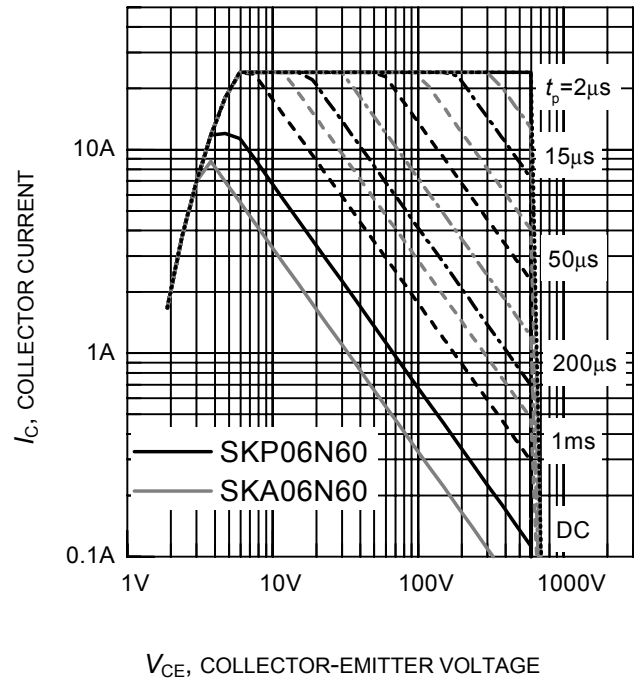

Figure 2. Safe operating area
 ($D = 0$, $T_C = 25^\circ\text{C}$, $T_j \leq 150^\circ\text{C}$)

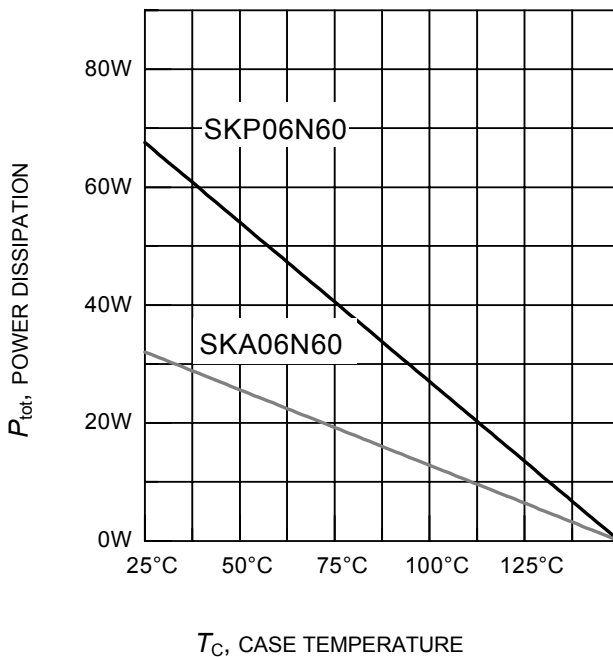

Figure 3. Power dissipation as a function of case temperature
 ($T_j \leq 150^\circ\text{C}$)

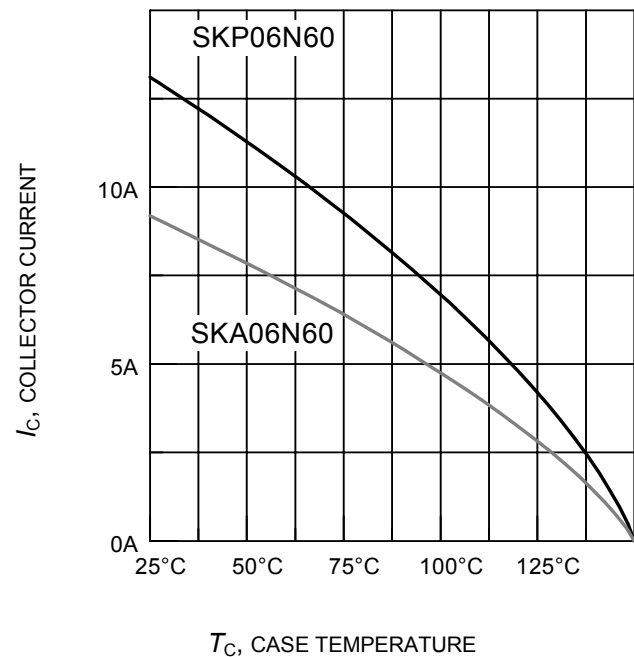

Figure 4. Collector current as a function of case temperature
 ($V_{GE} \leq 15\text{V}$, $T_j \leq 150^\circ\text{C}$)

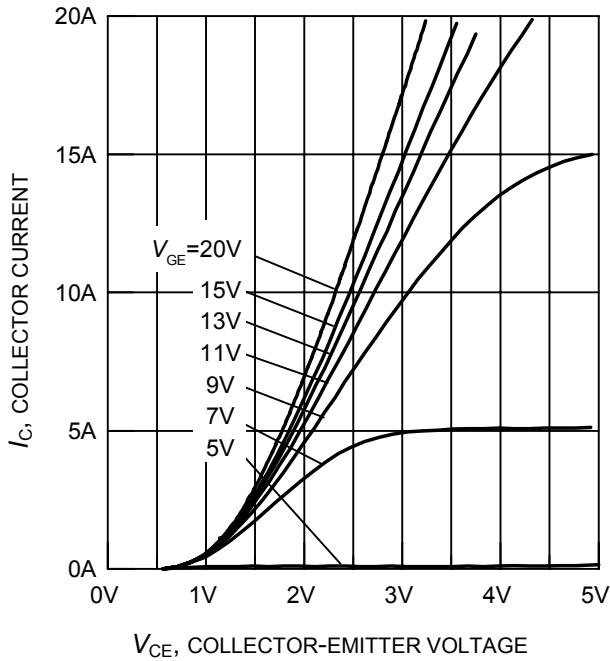

Figure 5. Typical output characteristics
($T_j = 25^\circ\text{C}$)

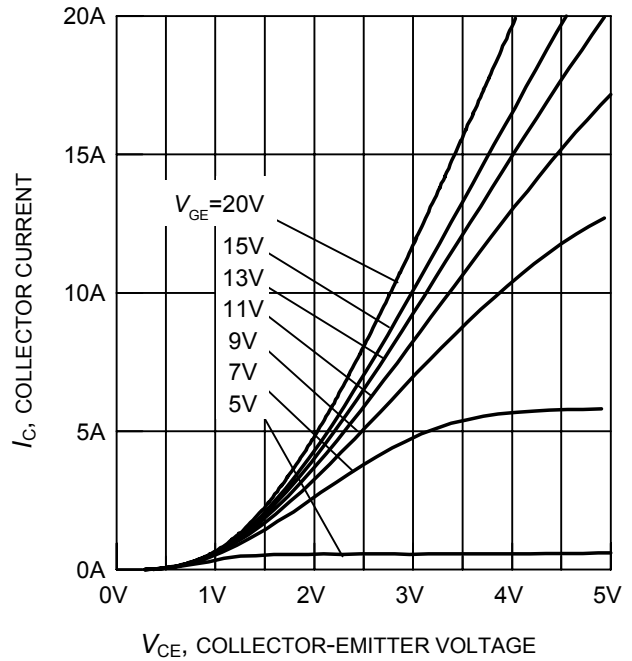

Figure 6. Typical output characteristics
($T_j = 150^\circ\text{C}$)

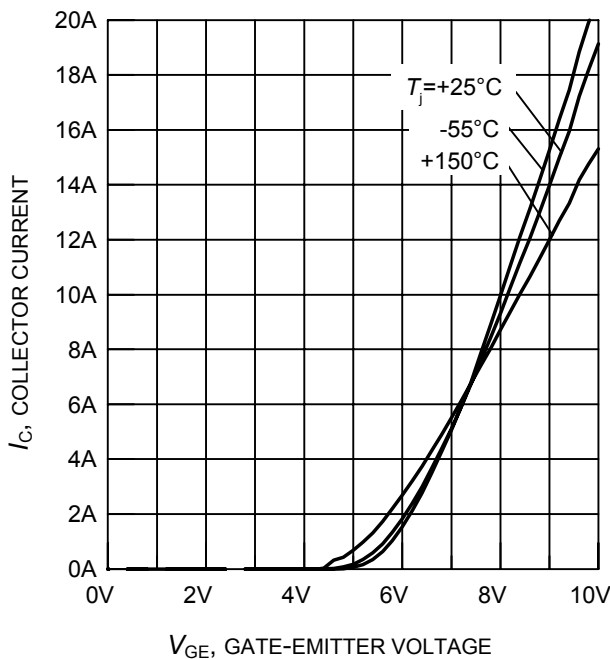

Figure 7. Typical transfer characteristics
($V_{CE} = 10\text{V}$)

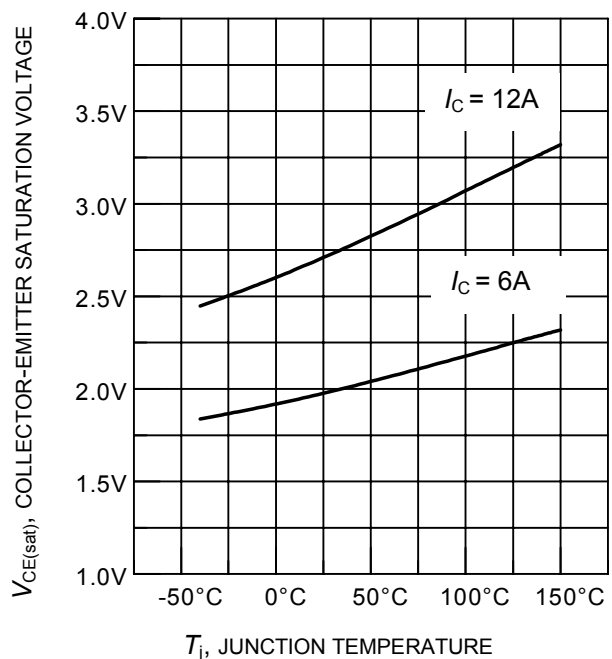

Figure 8. Typical collector-emitter saturation voltage as a function of junction temperature
($V_{GE} = 15\text{V}$)

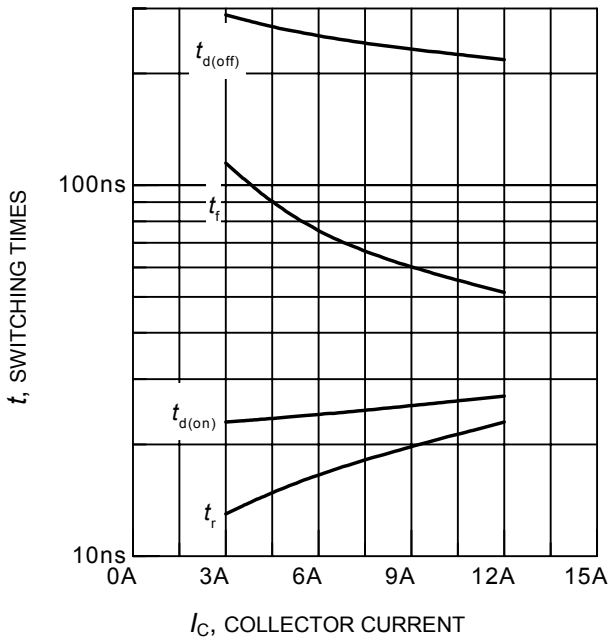

Figure 9. Typical switching times as a function of collector current
(inductive load, $T_j = 150^\circ\text{C}$, $V_{CE} = 400\text{V}$, $V_{GE} = 0/+15\text{V}$, $R_G = 50\Omega$, Dynamic test circuit in Figure E)

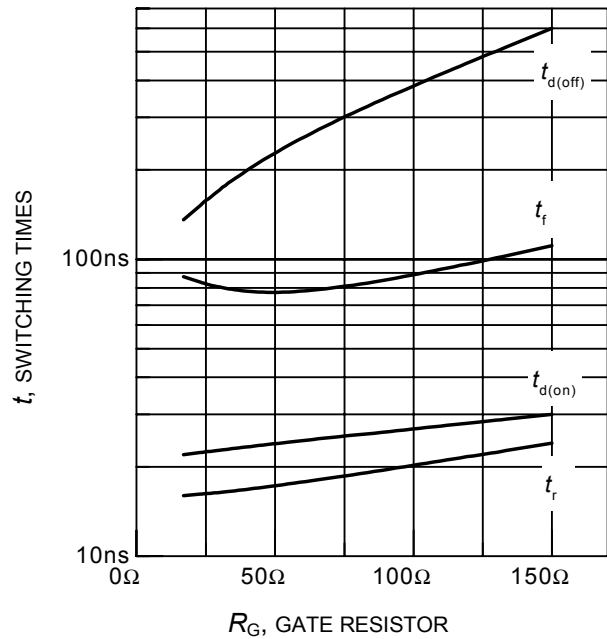

Figure 10. Typical switching times as a function of gate resistor
(inductive load, $T_j = 150^\circ\text{C}$, $V_{CE} = 400\text{V}$, $V_{GE} = 0/+15\text{V}$, $I_C = 6\text{A}$, Dynamic test circuit in Figure E)

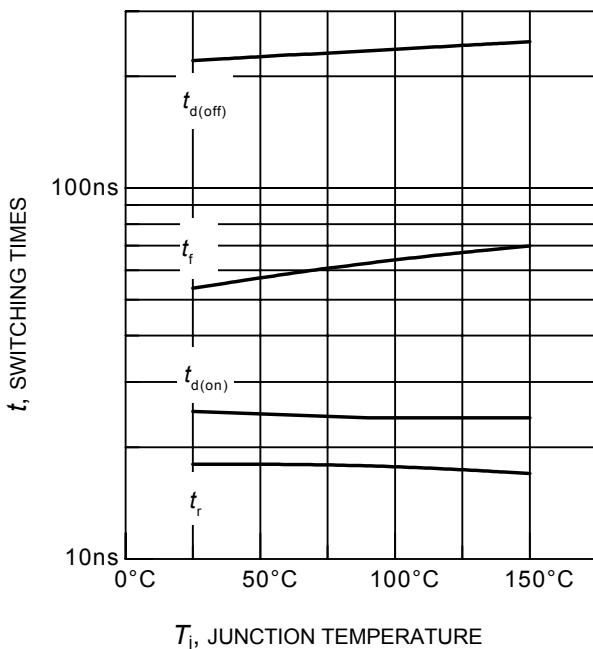

Figure 11. Typical switching times as a function of junction temperature
(inductive load, $V_{CE} = 400\text{V}$, $V_{GE} = 0/+15\text{V}$, $I_C = 6\text{A}$, $R_G = 50\Omega$, Dynamic test circuit in Figure E)

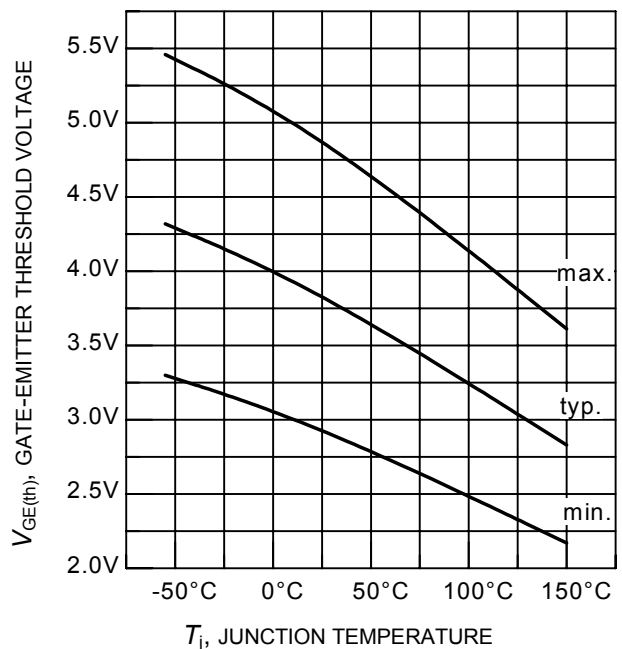

Figure 12. Gate-emitter threshold voltage as a function of junction temperature
($I_C = 0.25\text{mA}$)

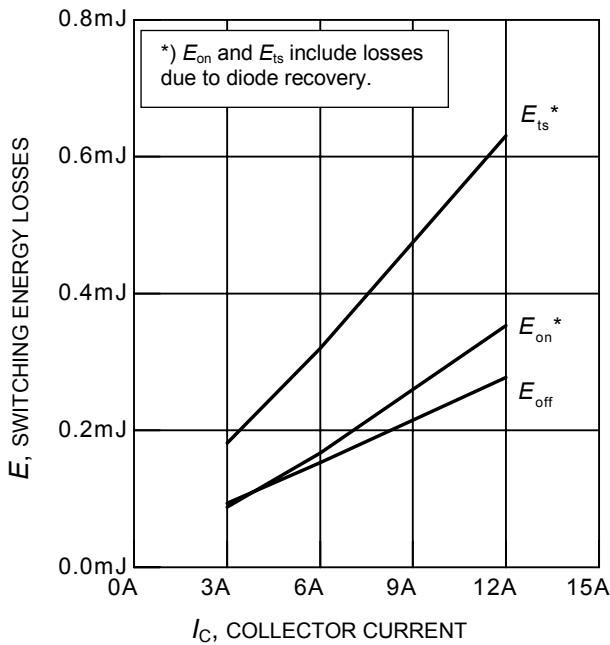

Figure 13. Typical switching energy losses as a function of collector current
(inductive load, $T_j = 150^\circ\text{C}$, $V_{CE} = 400\text{V}$, $V_{GE} = 0/+15\text{V}$, $R_G = 50\Omega$, Dynamic test circuit in Figure E)

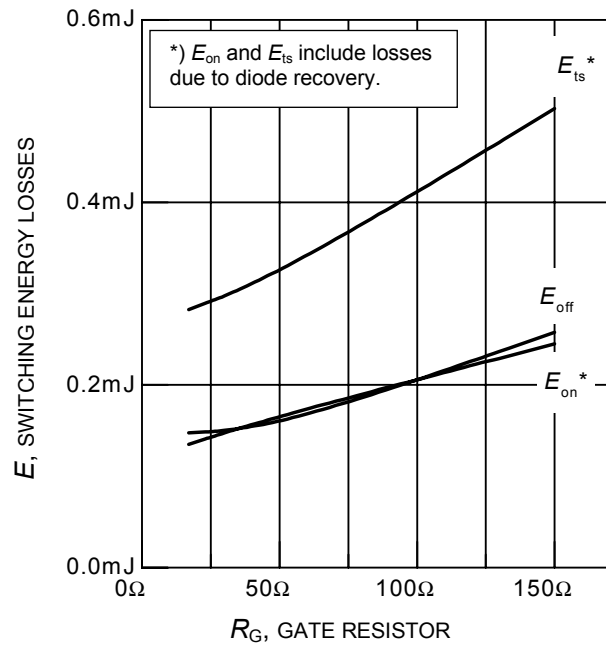

Figure 14. Typical switching energy losses as a function of gate resistor
(inductive load, $T_j = 150^\circ\text{C}$, $V_{CE} = 400\text{V}$, $V_{GE} = 0/+15\text{V}$, $I_C = 6\text{A}$, Dynamic test circuit in Figure E)

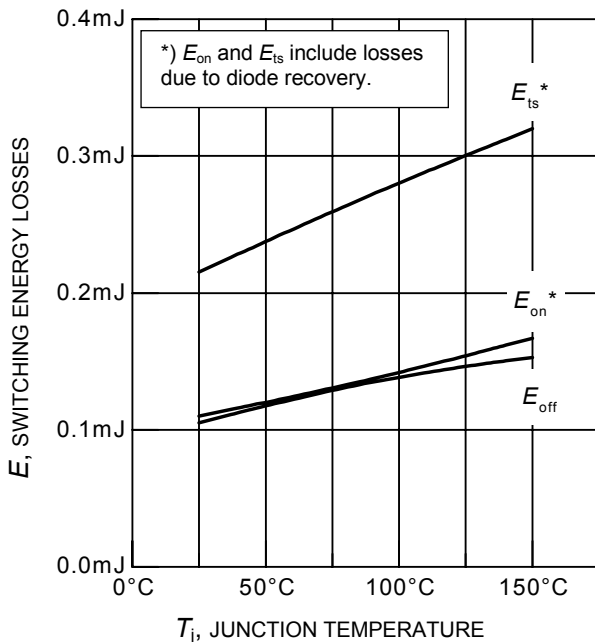

Figure 15. Typical switching energy losses as a function of junction temperature
(inductive load, $V_{CE} = 400\text{V}$, $V_{GE} = 0/+15\text{V}$, $I_C = 6\text{A}$, $R_G = 50\Omega$, Dynamic test circuit in Figure E)

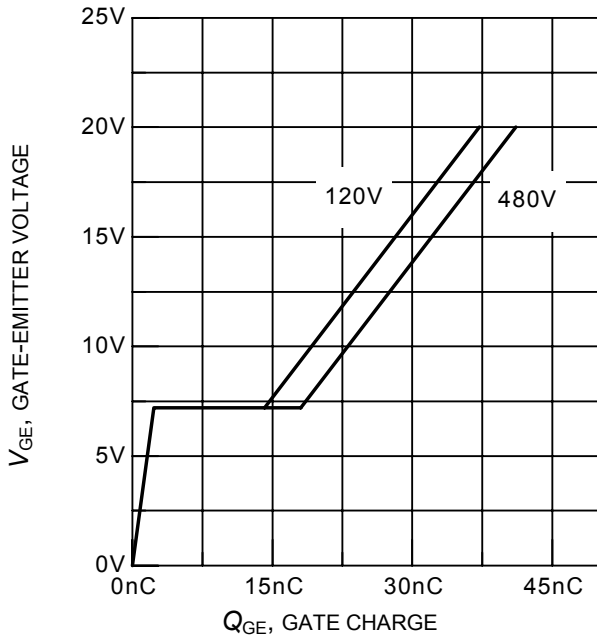

Figure 16. Typical gate charge
($I_C = 6A$)

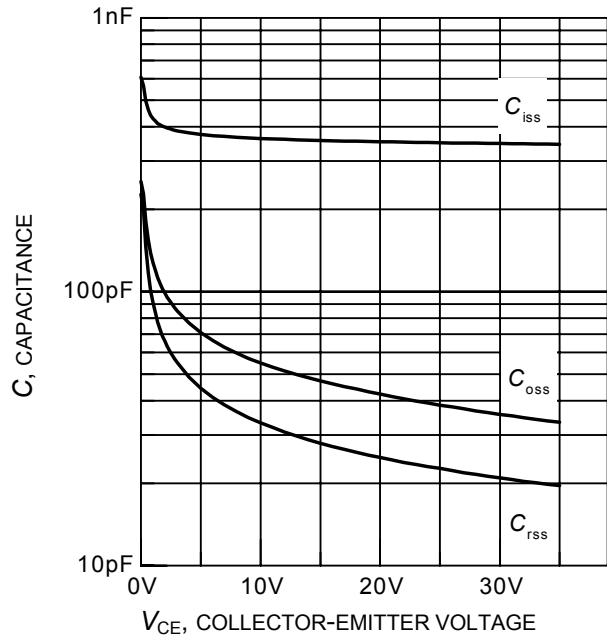

Figure 17. Typical capacitance as a function of collector-emitter voltage
($V_{GE} = 0V, f = 1MHz$)

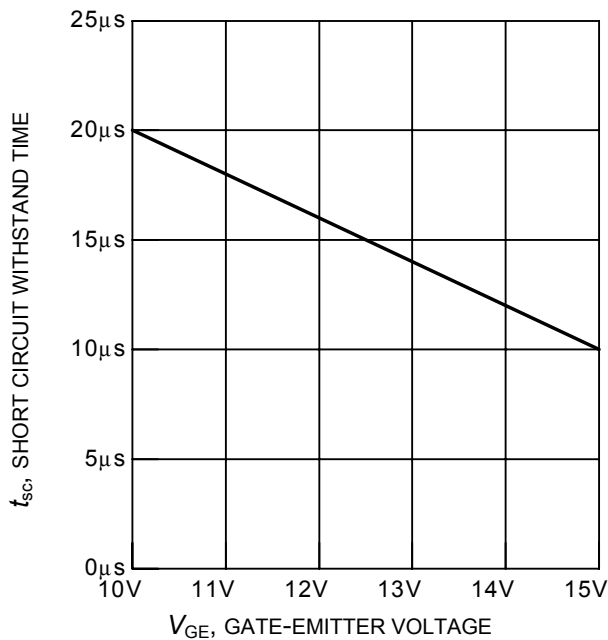

Figure 18. Short circuit withstand time as a function of gate-emitter voltage
($V_{CE} = 600V, \text{start at } T_j = 25^\circ C$)

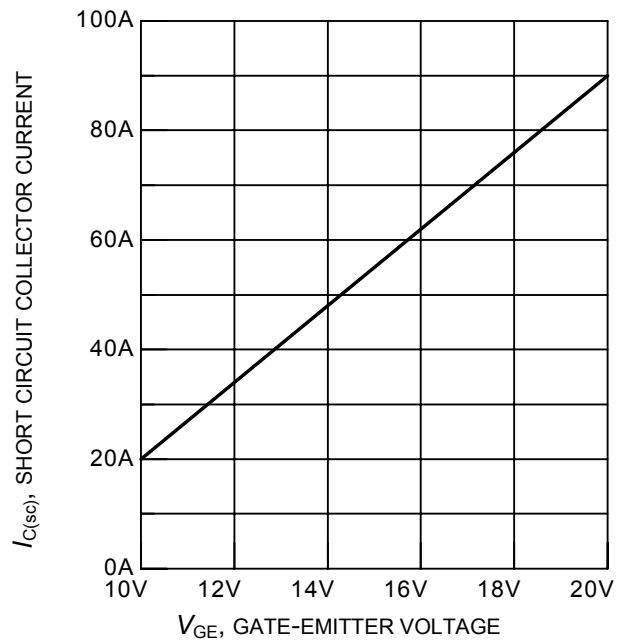

Figure 19. Typical short circuit collector current as a function of gate-emitter voltage
($V_{CE} \leq 600V, T_j = 150^\circ C$)

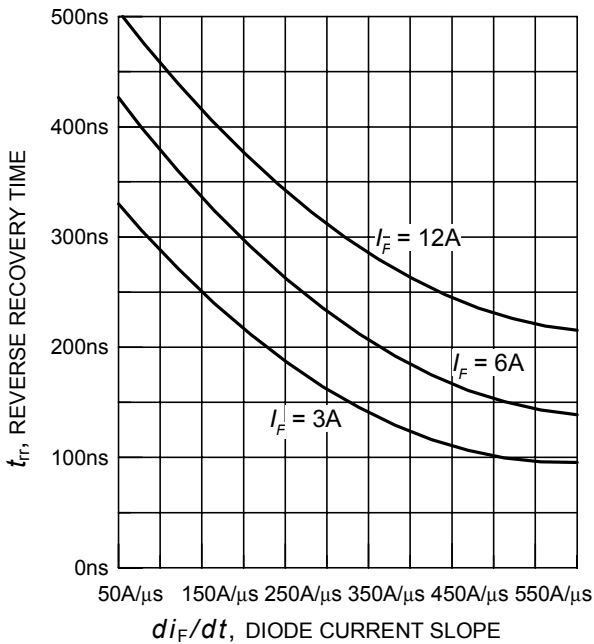

Figure 20. Typical reverse recovery time as a function of diode current slope
($V_R = 200V$, $T_j = 125^\circ C$,
Dynamic test circuit in Figure E)

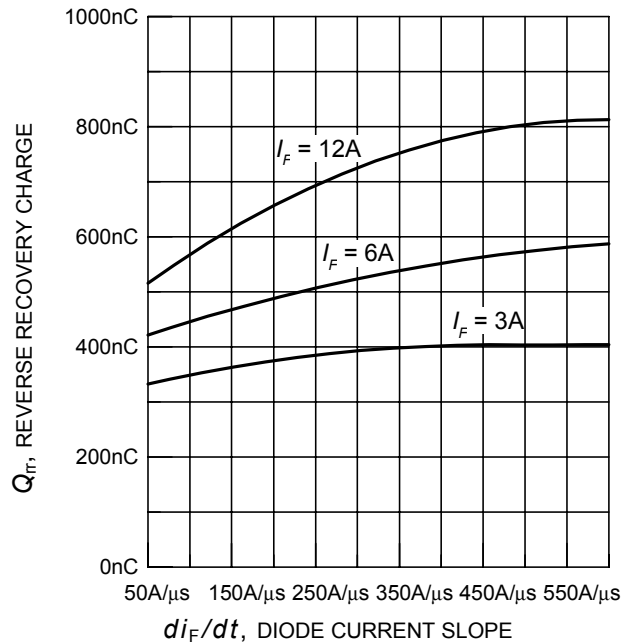

Figure 21. Typical reverse recovery charge as a function of diode current slope
($V_R = 200V$, $T_j = 125^\circ C$,
Dynamic test circuit in Figure E)

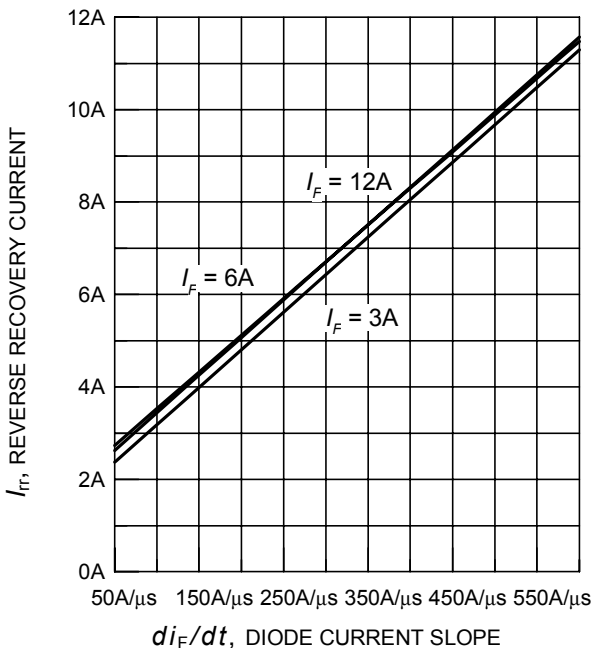

Figure 22. Typical reverse recovery current as a function of diode current slope
($V_R = 200V$, $T_j = 125^\circ C$,
Dynamic test circuit in Figure E)

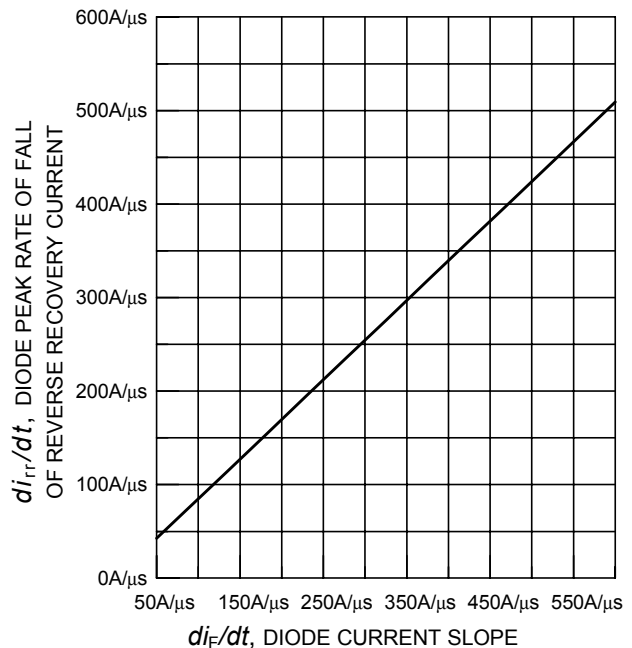

Figure 23. Typical diode peak rate of fall of reverse recovery current as a function of diode current slope
($V_R = 200V$, $T_j = 125^\circ C$,
Dynamic test circuit in Figure E)

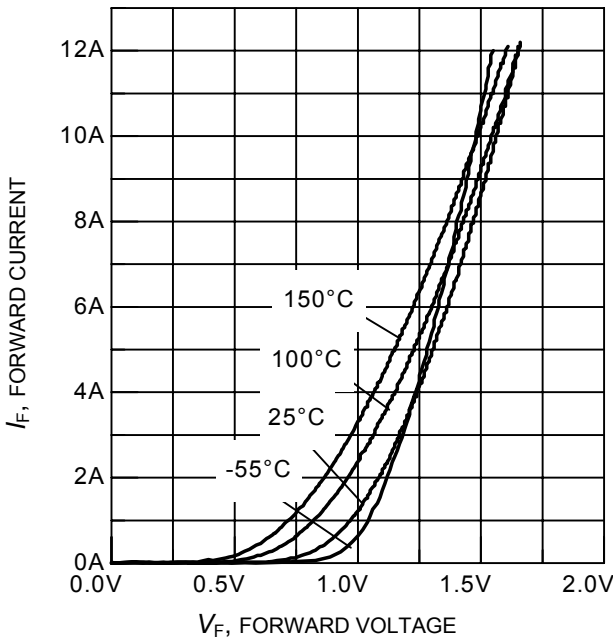

Figure 24. Typical diode forward current as a function of forward voltage

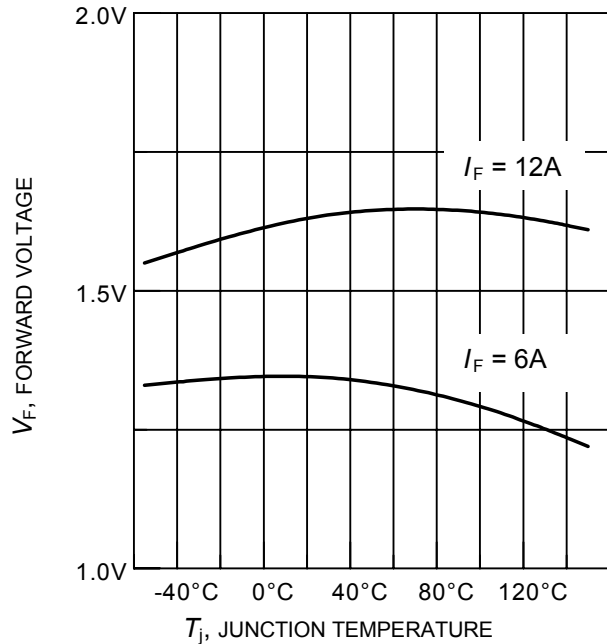

Figure 25. Typical diode forward voltage as a function of junction temperature

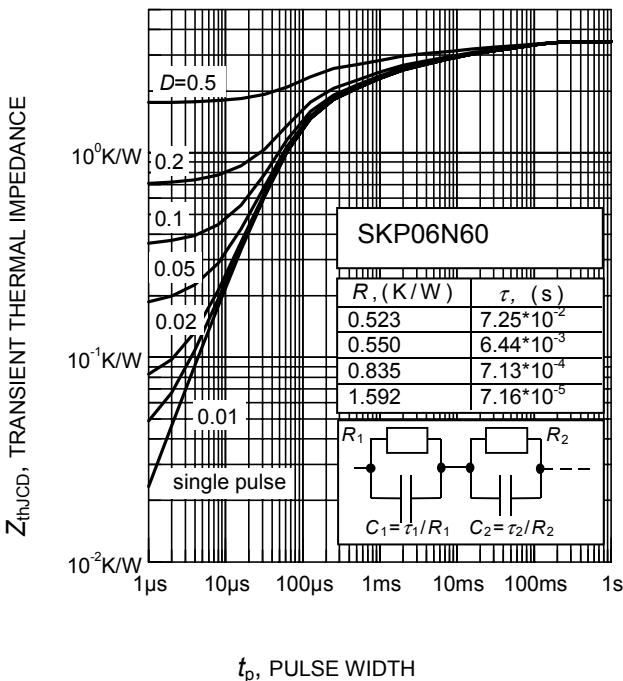

Figure 26. Diode transient thermal impedance as a function of pulse width ($D = t_p / T$)

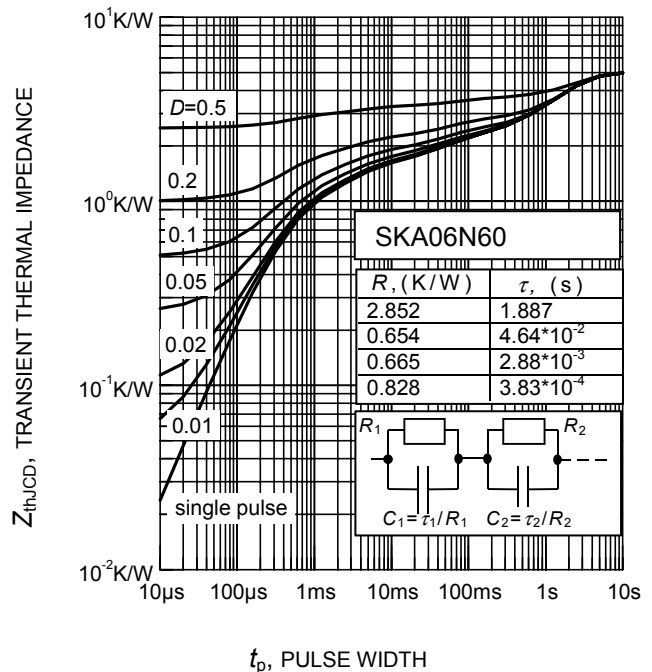

Figure 27. Diode transient thermal impedance as a function of pulse width ($D = t_p / T$)

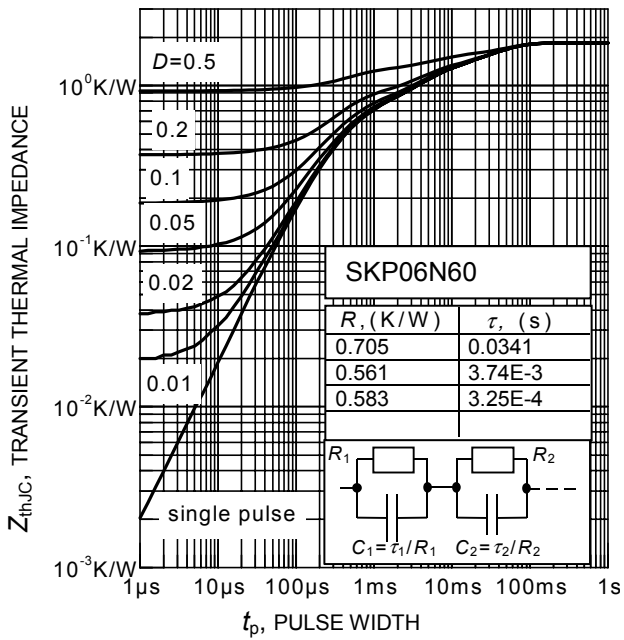

Figure 28. IGBT transient thermal impedance as a function of pulse width
($D = t_p / T$)

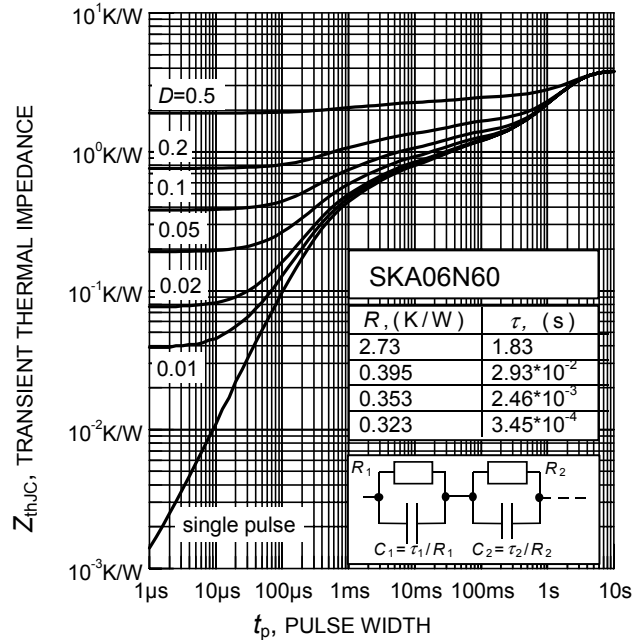
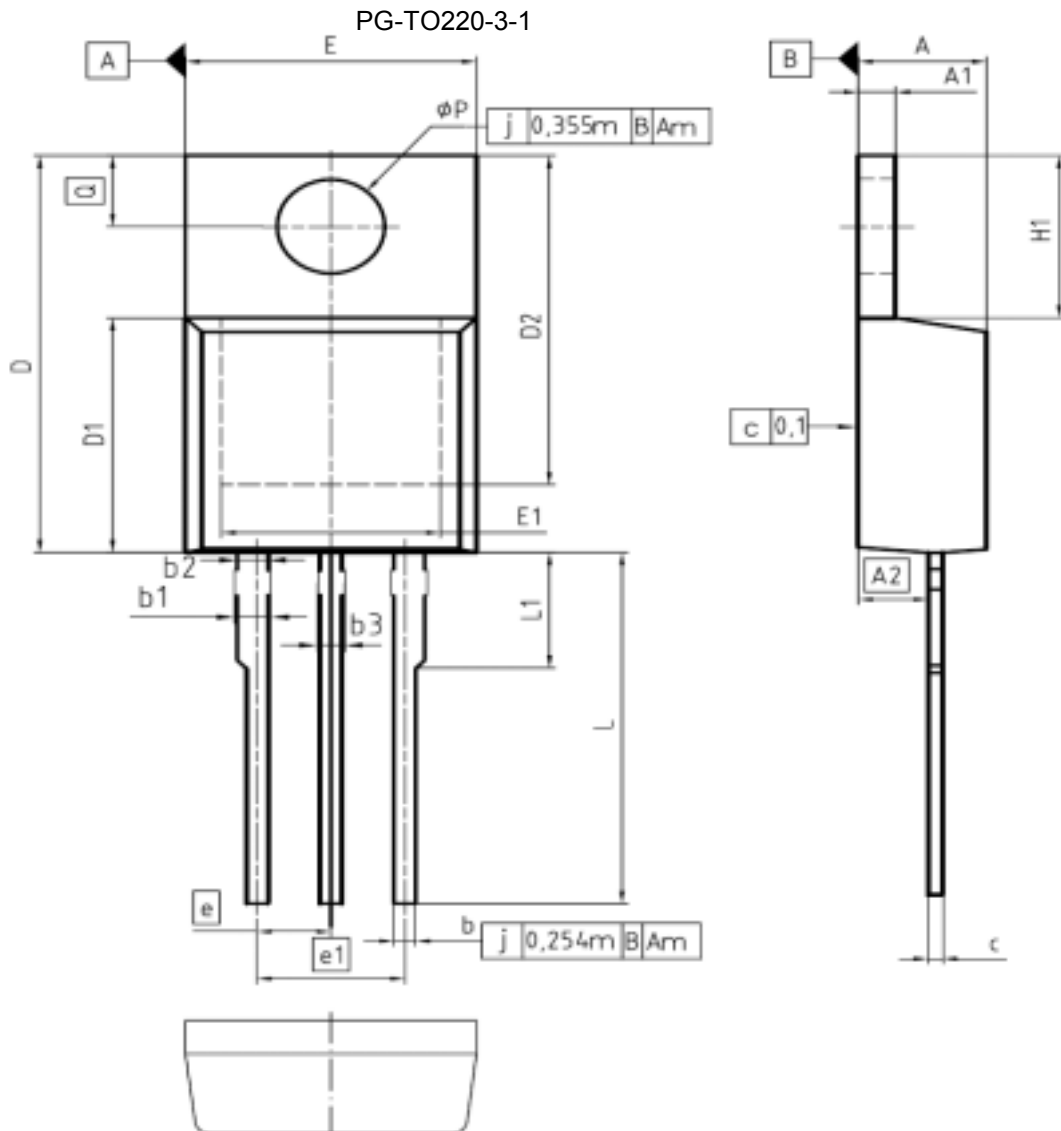

Figure 29. IGBT transient thermal impedance as a function of pulse width
($D = t_p / T$)



DIM	MILLIMETERS		INCHES	
	MIN	MAX	MIN	MAX
A	4.30	4.57	0.169	0.180
A1	1.17	1.40	0.046	0.055
A2	2.15	2.72	0.085	0.107
b	0.65	0.86	0.026	0.034
b1	0.95	1.40	0.037	0.055
b2	0.95	1.15	0.037	0.045
b3	0.65	1.15	0.026	0.045
c	0.33	0.60	0.013	0.024
D	14.81	15.95	0.583	0.628
D1	8.51	9.45	0.335	0.372
D2	12.19	13.10	0.480	0.516
E	9.70	10.36	0.382	0.408
E1	6.50	8.60	0.256	0.339
e	2.54		0.100	
e1	5.08		0.200	
N	3		3	
H1	5.90	6.90	0.232	0.272
L	13.00	14.00	0.512	0.551
L1	-	4.80	-	0.189
phi P	3.60	3.89	0.142	0.153
Q	2.60	3.00	0.102	0.118

DOCUMENT NO.
Z8B00003318

SCALE 0 2.5 5mm

EUROPEAN PROJECTION

ISSUE DATE
23-08-2007

REVISION
05

PG-TO220-3-31 / PG-TO220-3-111

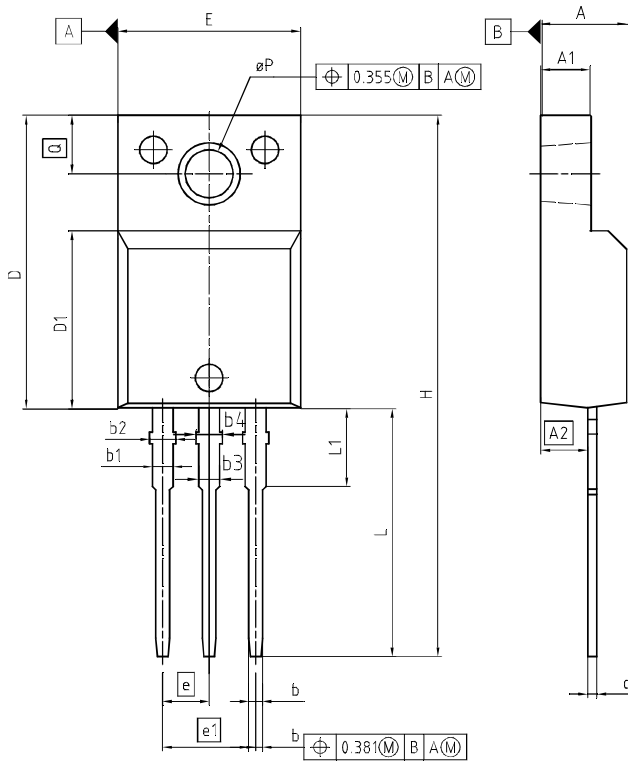

DIM	MILLIMETERS		INCHES	
	MIN	MAX	MIN	MAX
A	4.55	4.85	0.179	0.191
A1	2.55	2.85	0.100	0.112
A2	2.42	2.72	0.095	0.107
b	0.65	0.85	0.026	0.033
b1	0.95	1.33	0.037	0.052
b2	0.95	1.51	0.037	0.059
b3	0.65	1.33	0.026	0.052
b4	0.65	1.51	0.026	0.059
c	0.40	0.63	0.016	0.025
D	15.85	16.15	0.624	0.636
D1	9.53	9.83	0.375	0.387
E	10.35	10.65	0.407	0.419
e	2.54		0.100	
e1	5.08		0.200	
N	3		3	
H	29.45	29.75	1.159	1.171
L	13.45	13.75	0.530	0.541
L1	3.15	3.45	0.124	0.136
ϕP	2.95	3.20	0.116	0.126
Q	3.15	3.50	0.124	0.138

Please refer to mounting instructions

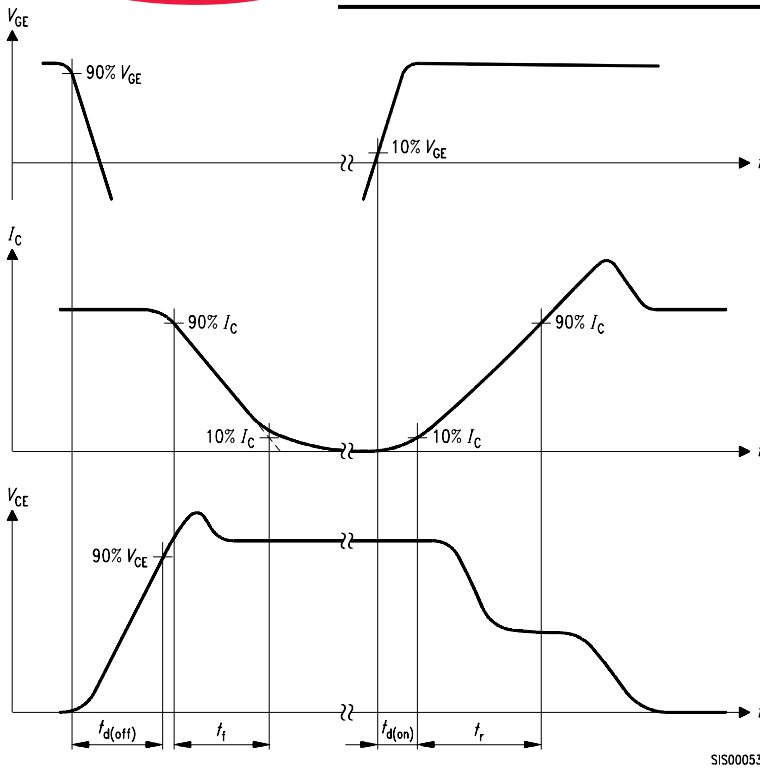

Figure A. Definition of switching times

SIS00053

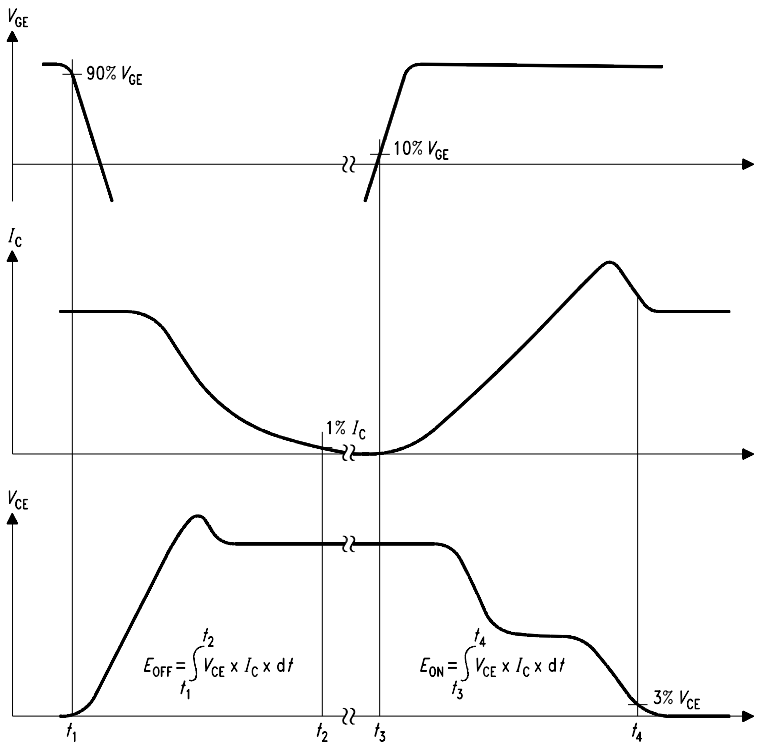

Figure B. Definition of switching losses

SIS00050

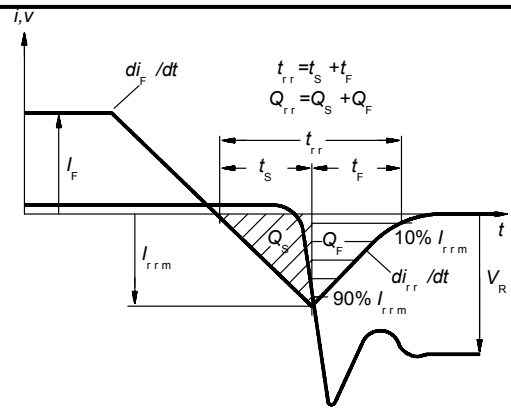

Figure C. Definition of diodes switching characteristics

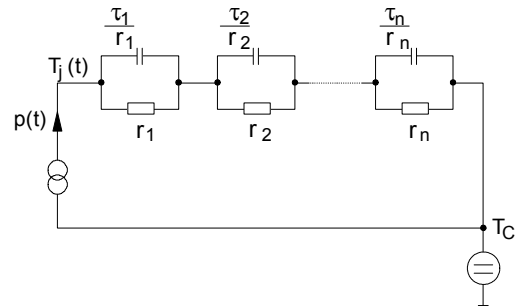

Figure D. Thermal equivalent circuit

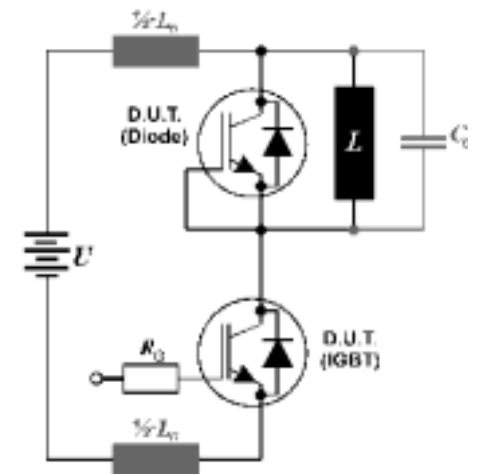

Figure E. Dynamic test circuit
Leakage inductance $L_\sigma = 180\text{nH}$
and Stray capacity $C_\sigma = 250\text{pF}$.

Edition 2006-01

Published by
Infineon Technologies AG
81726 München, Germany

© Infineon Technologies AG 9/12/07.
All Rights Reserved.

Attention please!

The information given in this data sheet shall in no event be regarded as a guarantee of conditions or characteristics ("Beschaffenhheitsgarantie"). With respect to any examples or hints given herein, any typical values stated herein and/or any information regarding the application of the device, Infineon Technologies hereby disclaims any and all warranties and liabilities of any kind, including without limitation warranties of non-infringement of intellectual property rights of any third party.

Information

For further information on technology, delivery terms and conditions and prices please contact your nearest Infineon Technologies Office (www.infineon.com).

Warnings

Due to technical requirements components may contain dangerous substances. For information on the types in question please contact your nearest Infineon Technologies Office.

Infineon Technologies Components may only be used in life-support devices or systems with the express written approval of Infineon Technologies, if a failure of such components can reasonably be expected to cause the failure of that life-support device or system, or to affect the safety or effectiveness of that device or system. Life support devices or systems are intended to be implanted in the human body, or to support and/or maintain and sustain and/or protect human life. If they fail, it is reasonable to assume that the health of the user or other persons may be endangered.