

Plugs & Receptacles
Roughneck™ multi-pin and single pole connectors

CROUSE-HINDS
SERIES

Introducing
Roughneck™ connectors

Heavy duty control, instrumentation and single pole power



EATON

Powering Business Worldwide

Full portfolio of land-based drilling solutions

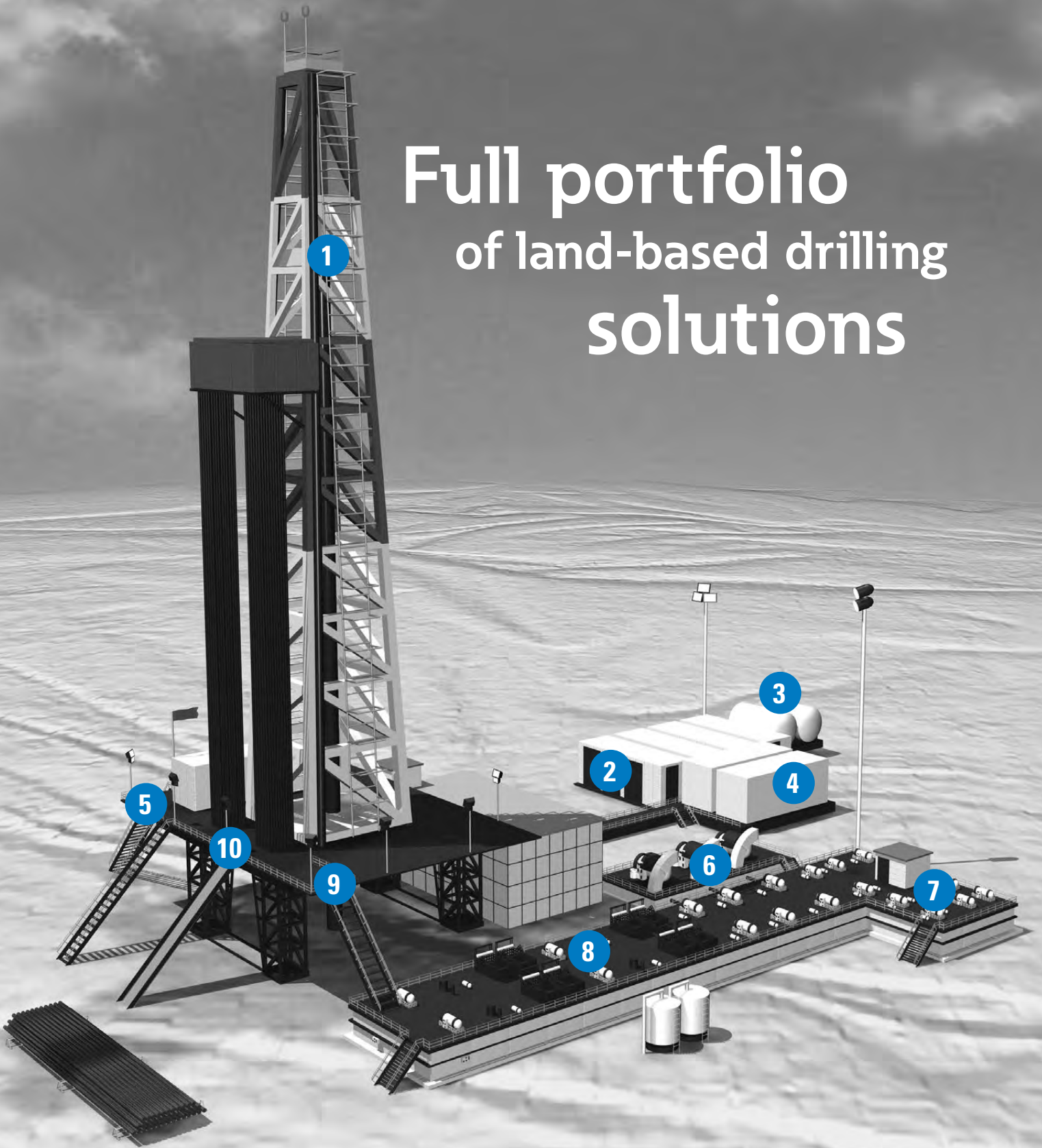

- 1 Derrick/Mast
- 2 VFD/Generators
- 3 Fuel Tank
- 4 Motor Control/VFD/SCR House
- 5 Doghouse/ Operator's House
- 6 Power/Pump Station
- 7 Shale Shaker
- 8 Mud Tanks/Pumps
- 9 Drawworks & Top Drive
- 10 Drilling Floor

Introducing Roughneck™ Connectors

Heavy duty control and instrumentation, single pole power

Rig Location
1, 2, 4, 5, 6, 9, 10



Crouse-Hinds Drilling Solutions

Single pole power

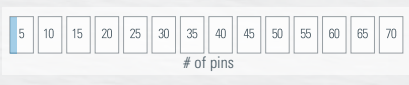

Roughneck™ Single Pole Series

Secure, single pole power, rated to 1135A for use in hazardous and normal locations. Ideal for delivering power to the top drive.
Rig Location
1, 2, 4, 5, 6, 9, 10

Roughneck™ Quick Connect

Quick connect, high amperage, single conductor connectors built to take heavy abuse while providing a simple, secure and safe connection.
Rig Location
2, 4, 5, 6, 9, 10

Cam-Lok™ Single Pole Series

Quickly connect and disconnect power systems safely. Used for motors, generators, indoor and outdoor lighting distribution panels, and numerous other power applications.
Rig Location
1, 2, 4, 5, 6, 9, 10

Low to medium amp power

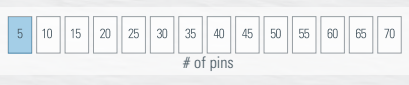

PowerGard™ Series

Supplies power to lighting systems, lighting panels and portable hand tools on land-based rigs.
Rig Location
1, 2, 3, 4, 5, 6, 7, 8, 9, 10

PowerMate™ Series

Supplies power to portable devices such as motor generator sets, compressors, heating and cooling, welders and lighting from 30 to 200A.
Rig Location
2, 4, 5

IEC 309 GHG 51 Series

Supplies power to portable devices with requirements of 16 to 125A and features an integrated AC3 rated disconnect switch. Reinforced polyester construction offers reliability from -20° to +55°C.
Rig Location
7, 8, 9

Multi-pin control

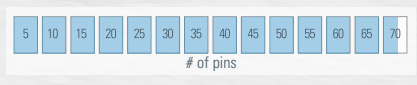

Roughneck™ Multi-pin Series

Heavy duty control and instrumentation multi-pin connectors for hazardous and harsh industrial use.
Rig Location
1, 2, 4, 5, 9, 10

Connectors for harsh/heavy industrial areas

Connectors for hazardous areas



Custom connections for land-based drilling

Overview

Introducing Roughneck	5
Catalog guide (by number of contacts in insert)	6

CZ & CRIG Series

Harsh/heavy industrial connectors

Technical reference	8
CZ Series, 12 shell overview	10
CZ Series, 12 shell full connector ordering information	12
CZ Series, 16 shell overview	14
CZ Series, 16 shell full connector ordering information	16
CZ Series, 20 shell overview	18
CZ Series, 20 shell full connector ordering information	20
CZ Series, 24 shell overview	22
CZ Series, 24 shell full connector ordering information	24
CZ Series, 28 shell overview	26
CZ Series, 28 shell full connector ordering information	28
CRIG Single Pole Series, full overview	30
CRIG Single Pole Series, full connector ordering information	32

CEX Series

Hazardous-rated connectors

Technical reference	34
CEX Series, 12 shell overview	36
CEX Series, 12 shell full connector ordering information	38
CEX Series, 16 shell overview	40
CEX Series, 16 shell full connector ordering information	42
CEX Series, 20 shell overview	44
CEX Series, 20 shell full connector ordering information	46
CEX Series, 24 shell overview	48
CEX Series, 24 shell full connector ordering information	50
CEX Series, 28 shell overview	52
CEX Series, 28 shell full connector ordering information	54
CEX Single Pole Series, full overview	56
CEX Single Pole Series, full connector ordering information	58

Individual components

Harsh/heavy industrial components

CZ Series, component parts ordering information	60-65
---	-------

Hazardous components

CEX Series, component parts ordering information	66-67
--	-------

Appendix

Tool reference	69
Insert index	70
12 shell, insert alternative clocking options	71
16 shell, insert alternative clocking options	72
20 shell, insert alternative clocking options	73
24 shell, insert alternative clocking options	74
28 shell, insert alternative clocking options	75

Introducing Roughneck™

Multi-pin and single pole connectors for hazardous and harsh industrial environments



Applications:

Heavy duty control and instrumentation, single pole power for hazardous and normal locations

Features & benefits:

- Intermateable with other brands (CZ & CRIG)
- Reversible inserts are compatible with all panel mount, in-line, male and female shells
- Exclusive visual mating alignment improves installation time
- Easily accessible wire terminals
- Multi-lam style contacts on single pole connectors deliver reliable continuity
- Ample wiring space within shells
- Reversible 8-point diamond cord grip relieves strain on conductors (patent pending)
- Suited for use with Type P cable
- Impact-resistant
- Hex grip on hazardous and normal location connectors facilitates torquing

Catalog guide

Service voltage ratings

MIL-DTL-5015 specifications

Service voltage	Non-circuit breaking	
	DC volts RMS	AC volts RMS
A	700	500
D	1250	900
E	1750	1250
B	2450	1750

NEC ratings

Service voltage	Non-circuit breaking	Circuit breaking
	DC volts RMS	AC volts RMS
A	250	240
D	600	600
E	600	600
B	600	600

Number of contacts	Insert suffix	Shell size	313 MCM (120)	444 MCM (185)	500 MCM (240)	646-777 MCM (300-400)	Voltage	CZ page #	CEX page #
-386	C24	-	-	-	1	1000V	32	58	
-444	C24	-	1	-	-	1000V	32	58	
-535	C24	-	-	1	-	1000V	32	58	

Number of contacts	Insert suffix	Shell size	16 AWG (1.5)	12 AWG (4.0)	10 AWG (6.0)	8 AWG (10.0)	Voltage	CZ page #	CEX page #
-330	12	-	3	-	-	D	12	38	

Number of contacts	Insert suffix	Shell size	16 AWG (1.5)	12 AWG (4.0)	10 AWG (6.0)	8 AWG (10.0)	4 AWG (25.0)	1/0 AWG (55.0)	4/0 AWG (120.0)	Voltage	CZ page #	CEX page #
-316	12	-	-	4	-	-	-	-	D	12	38	
-333	12	4	-	-	-	-	-	-	D	12	38	
-328	16	-	-	-	4	-	-	-	D	16	42	
-322	12	-	-	4	-	-	-	-	D	12	38	
-322	16	-	-	-	-	4	-	-	D	16	42	
-38	16	-	-	-	-	4	-	-	D	16	42	
-40	C20	-	-	-	-	-	4	-	D	20	46	
-26	C24	-	-	-	-	-	-	4	D	24	50	
-38	C24	-	-	-	-	-	-	4	D	24	50	

Number of contacts	Insert suffix	Shell size	16 AWG (1.5)	12 AWG (4.0)	10 AWG (6.0)	4/0 AWG (120.0)	Voltage	CZ page #	CEX page #
-48	C24	-	2	-	3	A (12 AWG); D (4/0 AWG)	24	50	

Number of contacts	Insert suffix	Shell size	16 AWG (1.5)	12 AWG (4.0)	10 AWG (6.0)	8 AWG (10.0)	4 AWG (25.0)	4/0 AWG (120.0)	Voltage	CZ page #	CEX page #
-354	12	-	7	-	-	-	-	A	12	38	
-359	20	-	-	-	7	-	-	E	20	46	
-348	12	7	-	-	-	-	-	A	12	38	
-378	16	-	7	-	-	-	-	D	16	42	
-H44	C28	-	-	1	3	-	3	D	28	54	

Number of contacts	Insert suffix	Shell size	12 AWG (4.0)	1/0 AWG (55.0)	350 MCM (XXXX)	Voltage	CZ page #	CEX page #
-53	C24	4	4	-	A (12 AWG); B (1/0 AWG)	24	50	

Number of contacts	Insert suffix	Shell size	16 AWG (1.5)	12 AWG (14.0)	10 AWG (6.0)	8 AWG (10.0)	4 AWG (25.0)	Voltage	CZ page #	CEX page #
-355	12	10	-	-	-	-	A	12	38	
-376	16	-	6	4	-	-	D	16	42	
-381	16	-	6	4	-	-	D	16	42	

Number of contacts	Insert suffix	Shell size	16 AWG (1.5)	12 AWG (14.0)	10 AWG (6.0)	8 AWG (10.0)	4 AWG (25.0)	Voltage	CZ page #	CEX page #

CZ and CRIG multi-pin and single pole connectors for harsh/heavy industrial

Catalog guide

Number of contacts	Insert suffix	Shell size	16 AWG (1.5)	12 AWG (14.0)	10 AWG (6.0)	8 AWG (10.0)	Voltage	CZ page #	CEX page #
16	-325	16	16	–	–	–	D	16	42

Number of contacts	Insert suffix	Shell size	16 AWG (1.5)	12 AWG (4.0)	10 AWG (6.0)	8 AWG (10.0)	Voltage	CZ page #	CEX page #
19	-312	16	–	19	–	–	A	16	42
	-355	16	19	–	–	–	A	16	42
	-377	16	–	19	–	–	A	16	42
	-376	20	–	19	–	–	D	20	46
	-388	20	–	19	–	–	D	20	46

Number of contacts	Insert suffix	Shell size	16 AWG (1.5)	12 AWG (4.0)	8 AWG (10.0)	Voltage	CZ page #	CEX page #
20	-332	20	–	20	–	B Center, A Outer	20	46
	-334	20	16	–	4	D	20	46
	-387	20	–	20	–	B Center, A Outer	20	46

Number of contacts	Insert suffix	Shell size	16 AWG (1.5)	12 AWG (4.0)	8 AWG (10.0)	Voltage	CZ page #	CEX page #
22	-331	20	20	–	2	E (8 AWG); D (16 AWG)	20	46

Number of contacts	Insert suffix	Shell size	16 AWG (1.5)	12 AWG (4.0)	10 AWG (6.0)	8 AWG (10.0)	Voltage	CZ page #	CEX page #
27	-335	16	24	3	–	–	A	16	42

Number of contacts	Insert suffix	Shell size	16 AWG (1.5)	12 AWG (4.0)	10 AWG (6.0)	8 AWG (10.0)	Voltage	CZ page #	CEX page #
37	-321	16	37	–	–	–	A	16	42
	-350	20	–	37	–	–	A	20	46
	-386	20	–	37	–	–	A	20	46
	-371	24	37	–	–	–	D	24	50

Number of contacts	Insert suffix	Shell size	16 AWG (1.5)	12 AWG (4.0)	10 AWG (6.0)	8 AWG (10.0)	Voltage	CZ page #	CEX page #
42	-339	28	–	42	–	–	D	28	54

Number of contacts	Insert suffix	Shell size	16 AWG (1.5)	8 AWG (10.0)	Voltage	CZ page #	CEX page #
47	-354	20	45	2	D (8 AWG); A (16 AWG)	20	46

Number of contacts	Insert suffix	Shell size	16 AWG (1.5)	12 AWG (4.0)	10 AWG (6.0)	8 AWG (10.0)	Voltage	CZ page #	CEX page #
58	-352	24	–	58	–	–	A	24	50
	-384	24	–	58	–	–	A	24	50

Number of contacts	Insert suffix	Shell size	16 AWG (1.5)	12 AWG (4.0)	10 AWG (6.0)	8 AWG (10.0)	Voltage	CZ page #	CEX page #
68	-313	20	68	–	–	–	A	20	46

Number of contacts	Insert suffix	Shell size	16 AWG (1.5)	12 AWG (4.0)	10 AWG (6.0)	8 AWG (10.0)	Voltage	CZ page #	CEX page #
100	-313	24	100	–	–	–	A	24	50

CZ and CRIG Series

Multi-pin and single pole connectors for harsh/heavy industrial areas

Technical reference

Applications:

Heavy duty control and instrumentation, single pole power for harsh/heavy industrial areas

Certifications:

CZ Series

- UL recognized: UL1977
CSA: C22.2 No. 182.3
- CE marked

CRIG Series

- UL recognized: UL486A-486B
CSA: C22.2 No. 65-13
- CE marked

Environmental:

- IP68; NEMA 4X, 6P
- Ambient temperature:
Suitable for use from -60°C
to +55°C

Materials and finish:

- Contacts
 - Silver plated copper, crimp style and solder style
 - Nickel plated brass, pressure style
 - Multi-lam style contacts on single poles
 - Optional gold plated contacts (crimp only)
- Shells
 - High tensile strength aluminum; hard anodic coating per MIL-A-8625, Type III, olive drab color

- Inserts
 - Rigid insert: thermoplastic material
 - Resilient insert: silicone rubber



General specifications

Property	Standard	Test method
Humidity resistance	MIL-DTL-5015/MIL-STD-1344	Method 1002, Type I
Moisture resistance	MIL-DTL-5015/MIL-STD-1344	Method 1002, Type II, Test Condition A
Ingress	IEC60529	IPX8
Corrosion resistance	MIL-STD-1344	Meets Method 1001.1, Test Condition B
Dust resistance	IEC60529	IP6X
Vibration	MIL-DTL-5015/MIL-STD-1344	Method 2005, Test Condition II
Contact retention	MIL-DTL-5015/MIL-STD-1344	Method 2007.1



Electrical ratings

Overview of shell options with voltage ratings

Shell size	# of contacts	Contact size	Voltage rating
12	3 - 10	16 AWG - 10 AWG	A, D
16	4 - 37	16 AWG - 8 AWG	A, D
20	7 - 68	16 AWG - 8 AWG	A, B, D, E
24	37 - 100	16 AWG - 12 AWG	A, D
C24	1 - 4	313 MCM - 777 MCM	1000V
28	42	12 AWG	D
C28	7-8	12 AWG - 350 MCM	D, E

The voltage rating is specific to the contact configuration of the insert used. For individual insert voltage ratings, please reference catalog guide on pages 6-7.

Service voltage ratings

MIL-DTL-5015 specifications

Service voltage	Non-circuit breaking	
	DC volts RMS	AC volts RMS
A	700	500
D	1250	900
E	1750	1250
B	2450	1750

NEC ratings

Service voltage	Non-circuit breaking	Circuit breaking
	DC volts RMS	AC volts RMS
A	250	240
D	600	600
E	600	600
B	600	600

Contact amperage ratings

Contact size (AWG / MCM)	Non-circuit breaking current rating*
16 AWG	18
12 AWG	30
10 AWG	40
8 AWG	55
4 AWG	95
1/0 AWG	155
4/0 AWG	225
313 MCM	636
350 MCM (solder)	325
444 MCM	796
535 MCM	898
777 MCM	1135

* Cable current rating must meet or exceed the ratings of the contacts to utilize connector at fully rated current.

Consult the N.E.C. General Wiring Guidelines, Article 310 prior to installing cable. Guidelines around wire temperature rating, ambient temperature correction factors and the number of conductors may limit the maximum amperage of the individual conductors.



CZ series multi-pin connectors

12 Shell



Applications:

Heavy duty control and instrumentation

Certifications:

- UL recognized: UL1977
CSA: C22.2 No. 182.3
- CE marked

Environmental:

- IP68
- NEMA 4X, 6P

Ambient temperature:

- -60°C to +55°C

Construction:

- Contacts - silver plated copper, crimp or solder style; nickel plated brass, pressure style; optional gold plated (crimp only)
- Shells - high tensile strength aluminum; hard anodic coating per MIL-A-8625, Type III, olive drab color
- Rigid insulators - thermoplastic
- Resilient inserts - silicone rubber

Features & benefits:

- Intermateable with other brands
- Reversible inserts are compatible with all panel mount, in-line, male and female shells
- Exclusive visual mating alignment allows for easy installation
- Easily accessible wire terminals
- Ample wiring space within shells
- Double-lead thread coupling
- Reversible 8-point diamond cord grip relieves strain on conductors (patent pending)
- Suited for use with Type P cable
- Impact-resistant

Cable mounted receptacle with mechanical clamp

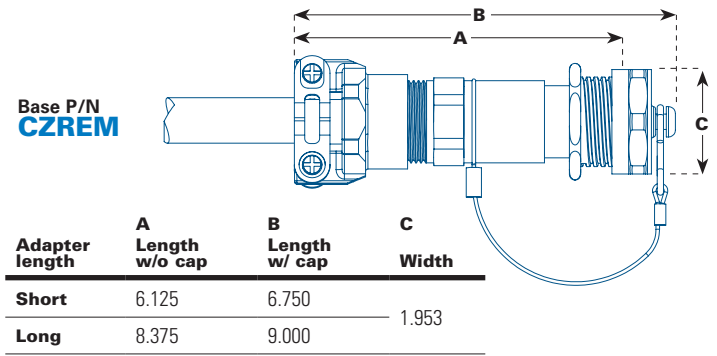

Cable mounted plug with mechanical clamp

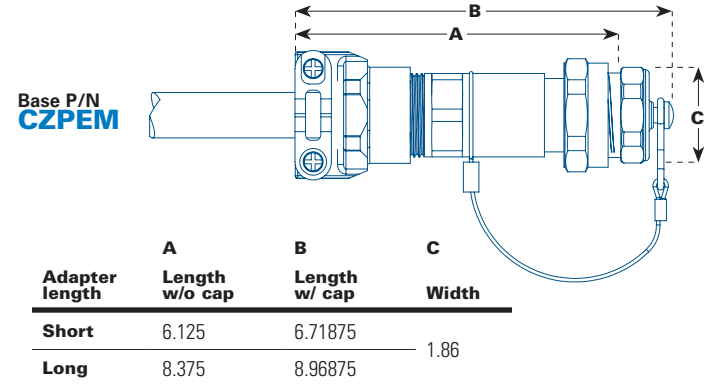

Receptacle with conduit adapter

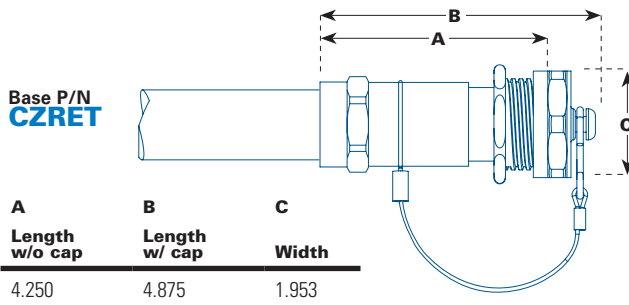

Cable mounted receptacle with gland nut

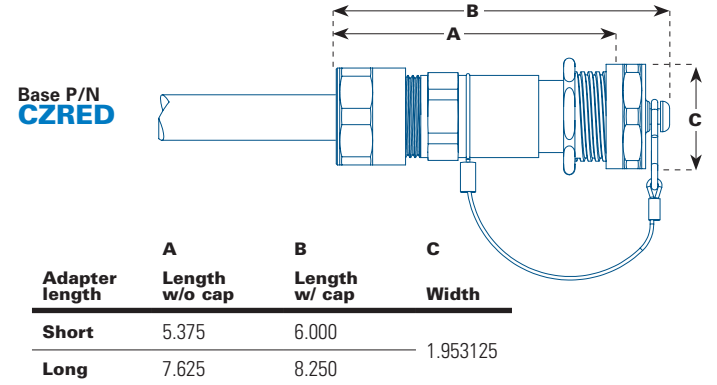

Plug with conduit adapter

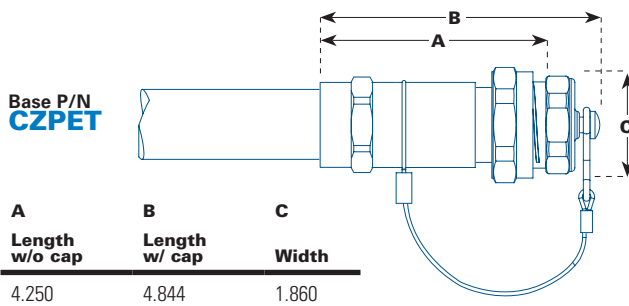

Cable mounted plug with gland nut

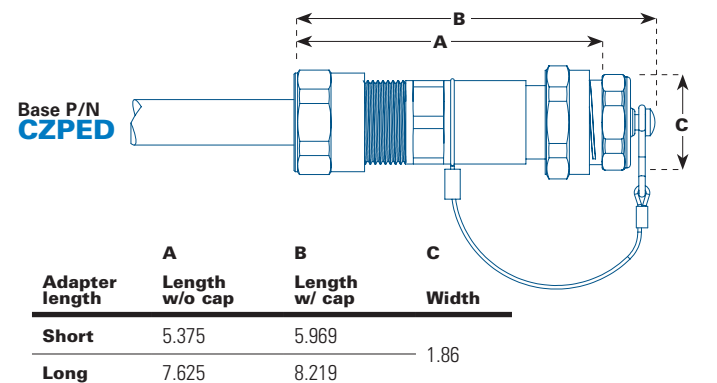

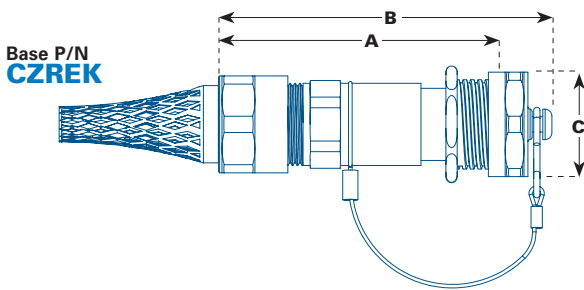

Cable mounted receptacle with basketweave

Adapter length	A Length w/o cap	B Length w/ cap	C Width
Short	5.375	6.000	1.953
Long	7.625	8.250	

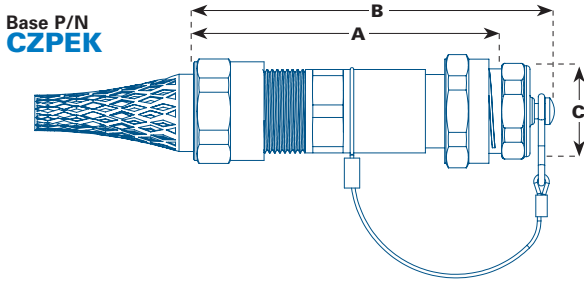

Cable mounted plug with basketweave

Adapter length	A Length w/o cap	B Length w/ cap	C Width
Short	5.375	5.969	1.860
Long	7.625	8.219	

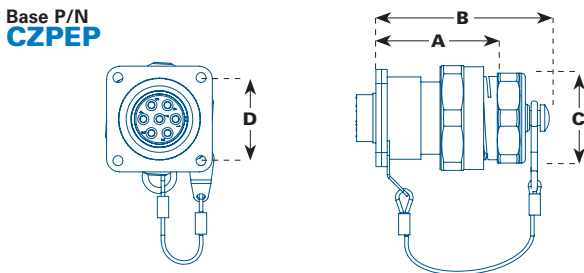

Panel mounted plug

A Length w/o cap	B Length w/ cap	C Width	D Ctr. - ctr. mount hole	Diameter Mount hole
2.375	2.969	1.860	1.266	.1875

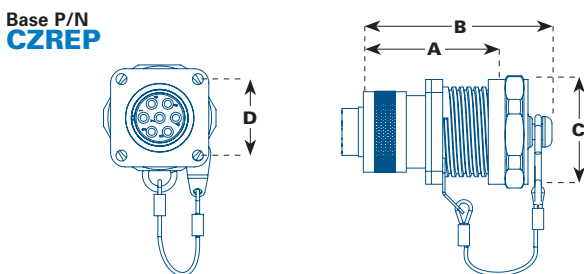

Panel mounted receptacle

A Length w/o cap	B Length w/ cap	C Width	D Ctr. - ctr. mount hole	Diameter Mount hole
2.328	2.938	1.750	1.375	0.166

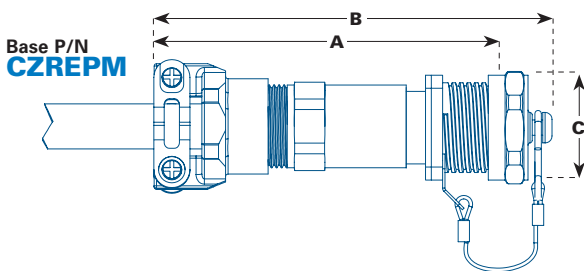

Cable mounted square flange receptacle with mechanical clamp

Adapter length	A Length w/o cap	B Length w/ cap	C Width	D Ctr. - ctr. mount hole	Diameter Mount hole
Short	6.125	6.750	1.750	1.375	0.166
Long	8.375	9.000			

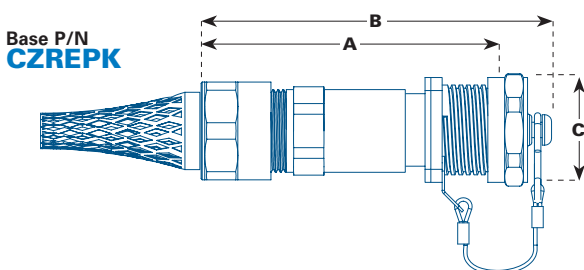

Cable mounted square flange receptacle with basketweave

Adapter length	A Length w/o cap	B Length w/ cap	C Width	D Ctr. - ctr. mount hole	Diameter Mount hole
Short	5.375	6.000	1.75	1.375	0.166
Long	7.625	8.250			

CZ series– 12 Shell

Example: CZ-PEKL-0812-310PN

CZ P E K L 08

Series

CZ Non-hazardous rated connector

Base call out

P Plug
R Receptacle

Environmental cover

E Environmental cover
L No cover

Cable hardware

K In-line cable mount w/ basketweave clamp
M In-line cable mount w/ mechanical clamp
D In-line cable mount w/ gland nut
P Panel mount

Adapter length

L Long
BLANK Standard or panel mount

Coupling nut

BLANK Standard coupling nut
J Jack nut

Grommet code

BLANK Panel mount
See table below In-line cable mount

Grommet

	Cable diameter	
	in.	mm.
03	.125 - .188	1.6 - 3.2
04	.125 - .250	3.2 - 6.4
06	.250 - .375	6.4 - 9.5
08	.375 - .500	9.5 - 12.7
10	.500 - .625	12.7 - 15.9
12	.625 - .750	15.9 - 19.1
14	.750 - .875	19.1 - 22.2

Contact amperage ratings

Contact size (AWG / MCM)	Non-circuit breaking current rating*
16 AWG	18
12 AWG	30
10 AWG	40

* Cable current rating must meet or exceed the ratings of the contacts to utilize connector at fully rated current.

NEC service voltage ratings

Service voltage	Non-circuit breaking DC volts RMS	Circuit breaking AC volts RMS
A	250	240
D	600	600
E	600	600
B	600	600

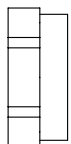

Cable hardware

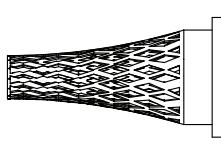

Grommet



Cable adapter

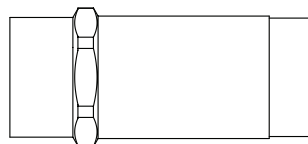

Insert

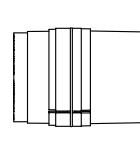

Skirt

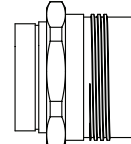

Environmental cover

12 310 P N

Shell size

12 Connector shell size

Contact gender

P Male pin
S Female socket

Key position

BLANK 0 degrees

See appendix p. 67 for locking options

Contact connection type

N Crimp
R Pressure

Plating

BLANK Silver (crimp or solder)
Nickel (pressure)
K Gold (crimp only)

Insert configuration

See all configurations below

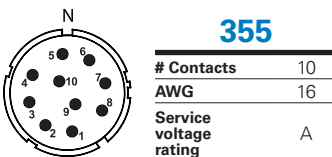
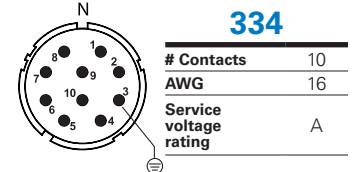
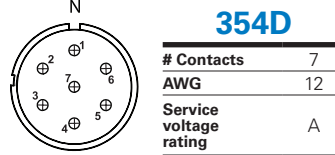
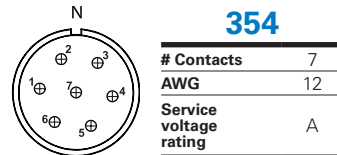
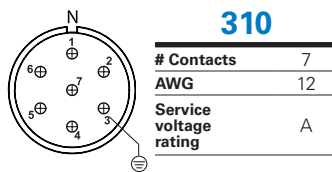
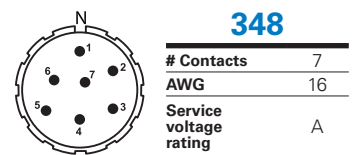
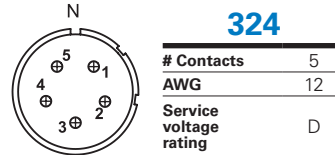
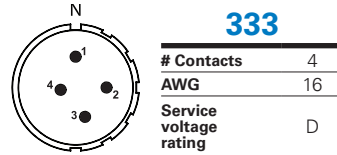
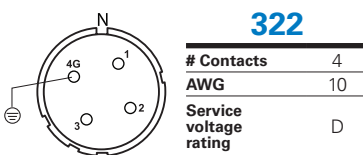
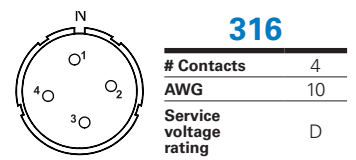
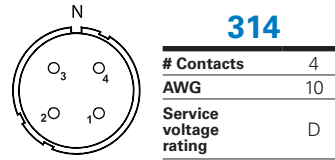
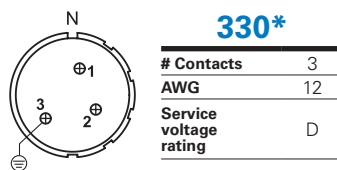
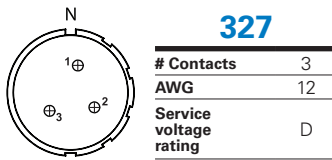

*Made to order item. Consult factory for availability and lead time.

Contact Symbol	○	●	⊕	○	⊙	●	⊕	⊗	⊕	⊗	○	⊗
AWG	18	16	12	10	8	4	1/0	4/0	313 MCM	444 MCM	535 MCM	777 MCM

CZ series multi-pin connectors

16 Shell

Applications:

Heavy duty control and instrumentation

Certifications:

- UL recognized: UL1977
CSA: C22.2 No. 182.3
- CE marked

Environmental:

- IP68
- NEMA 4X, 6P

Ambient temperature:

- -60°C to +55°C

Construction:

- Contacts - silver plated copper, crimp or solder style; nickel plated brass, pressure style; optional gold plated (crimp only)
- Shells - high tensile strength aluminum; hard anodic coating per MIL-A-8625, Type III, olive drab color
- Rigid insulators - thermoplastic
- Resilient inserts - silicone rubber



Features & benefits:

- Intermateable with other brands
- Reversible inserts are compatible with all panel mount, in-line, male and female shells
- Exclusive visual mating alignment allows for easy installation
- Easily accessible wire terminals
- Ample wiring space within shells
- Double-lead thread coupling
- Reversible 8-point diamond cord grip relieves strain on conductors (patent pending)
- Suited for use with Type P cable
- Impact-resistant

Cable mounted receptacle with mechanical clamp

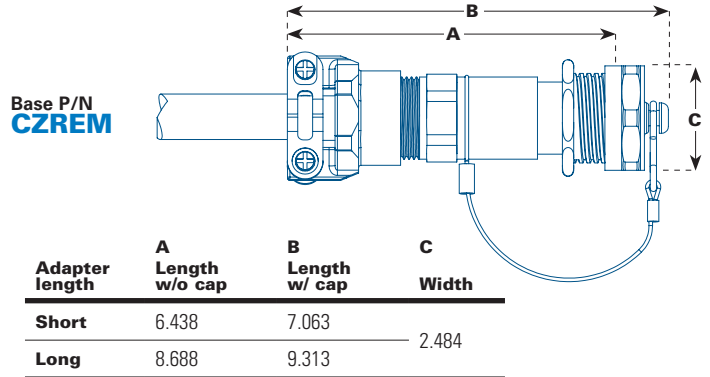

Cable mounted plug with mechanical clamp

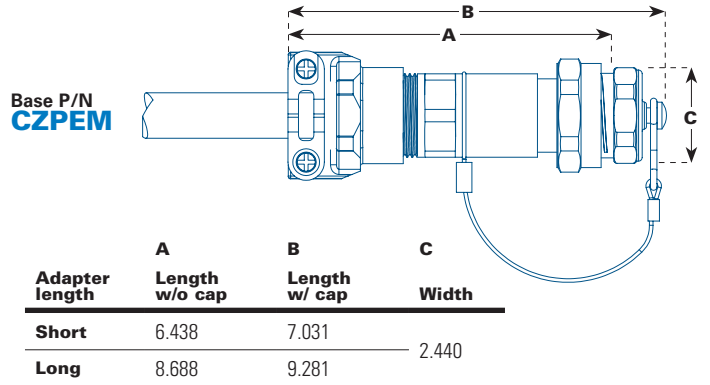

Receptacle with conduit adapter

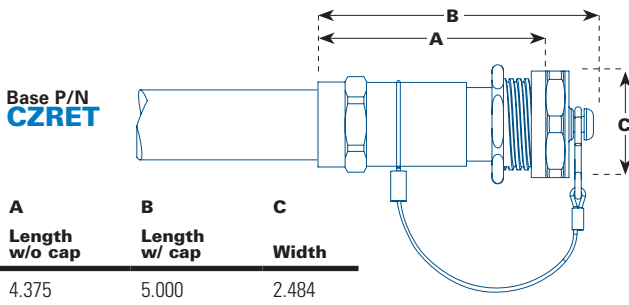

Cable mounted receptacle with gland nut

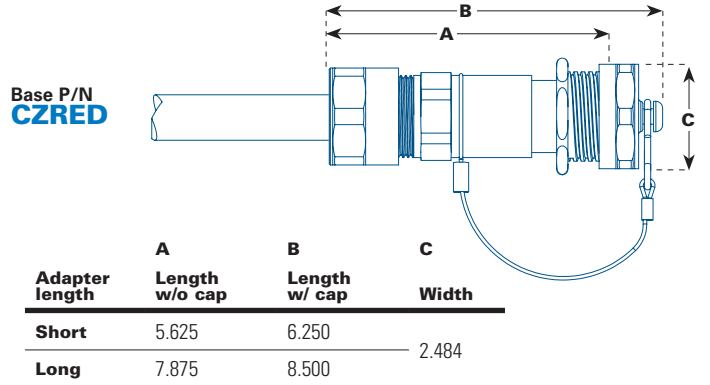

Plug with conduit adapter

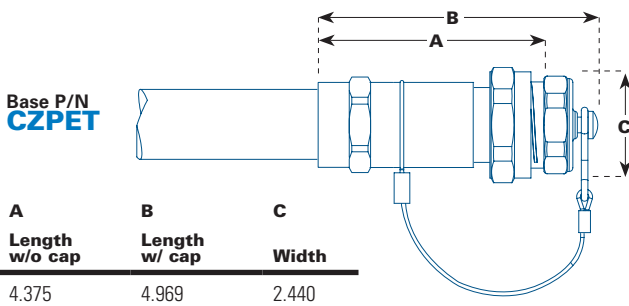

Cable mounted plug with gland nut

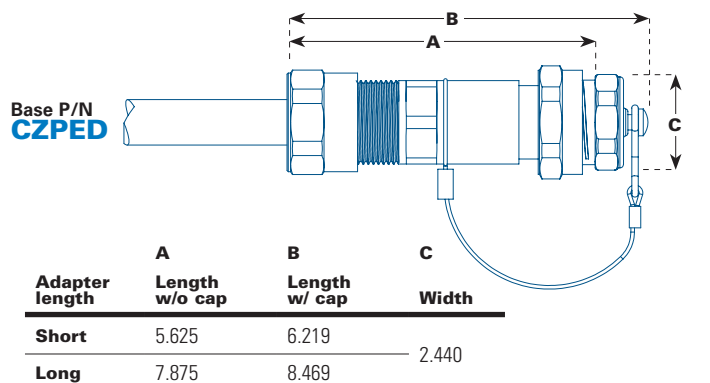

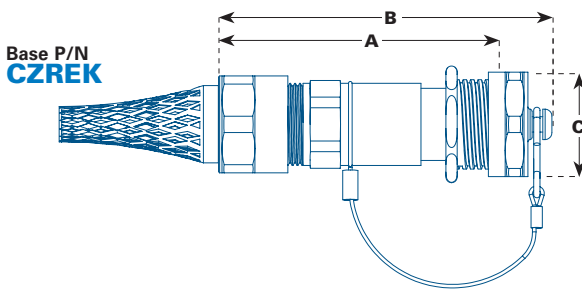

Cable mounted receptacle with basketweave

Adapter length	A Length w/o cap	B Length w/ cap	C Width
Short	5.625	6.250	2.484
Long	7.875	8.500	

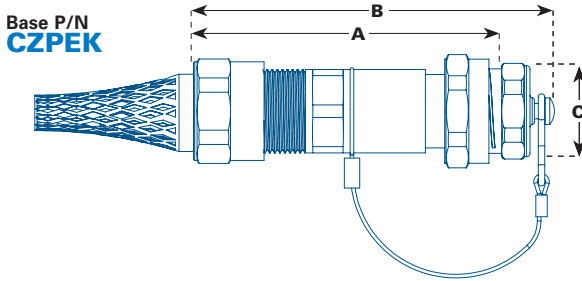

Cable mounted plug with basketweave

Adapter length	A Length w/o cap	B Length w/ cap	C Width
Short	5.625	6.219	2.440
Long	7.875	8.469	

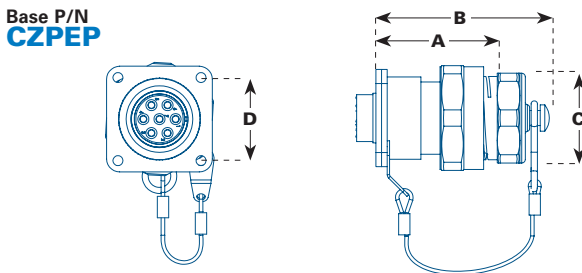

Panel mounted plug

A Length w/o cap	B Length w/ cap	C Width	D Ctr. - ctr. mount hole	Diameter Mount hole
2.406	3.000	2.440	1.688	0.194

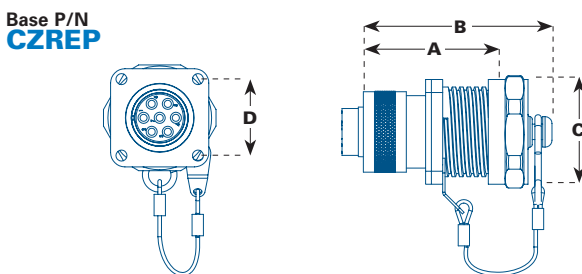

Panel mounted receptacle

A Length w/o cap	B Length w/ cap	C Width	D Ctr. - ctr. mount hole	Diameter Mount hole
2.328	2.938	2.250	1.688	0.194

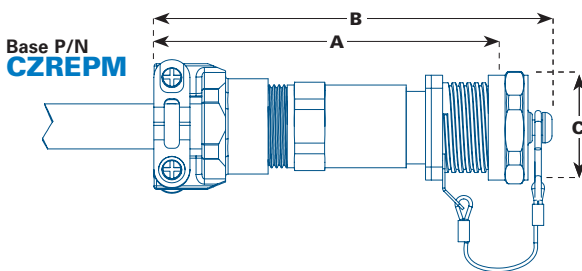

Cable mounted square flange receptacle with mechanical clamp

Adapter length	A Length w/o cap	B Length w/ cap	C Width	D Ctr. - ctr. mount hole	Diameter Mount hole
Short	6.438	7.063	2.250	1.688	0.194
Long	8.688	9.312			

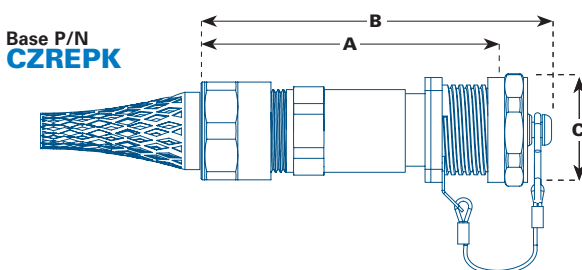

Cable mounted square flange receptacle with basketweave

Adapter length	A Length w/o cap	B Length w/ cap	C Width	D Ctr. - ctr. mount hole	Diameter Mount hole
Short	5.625	6.250	2.250	1.688	0.194
Long	7.875	8.500			

CZ series – 16 Shell

Example: CZ-PEKL-1016-381PN

CZ P E K L 10

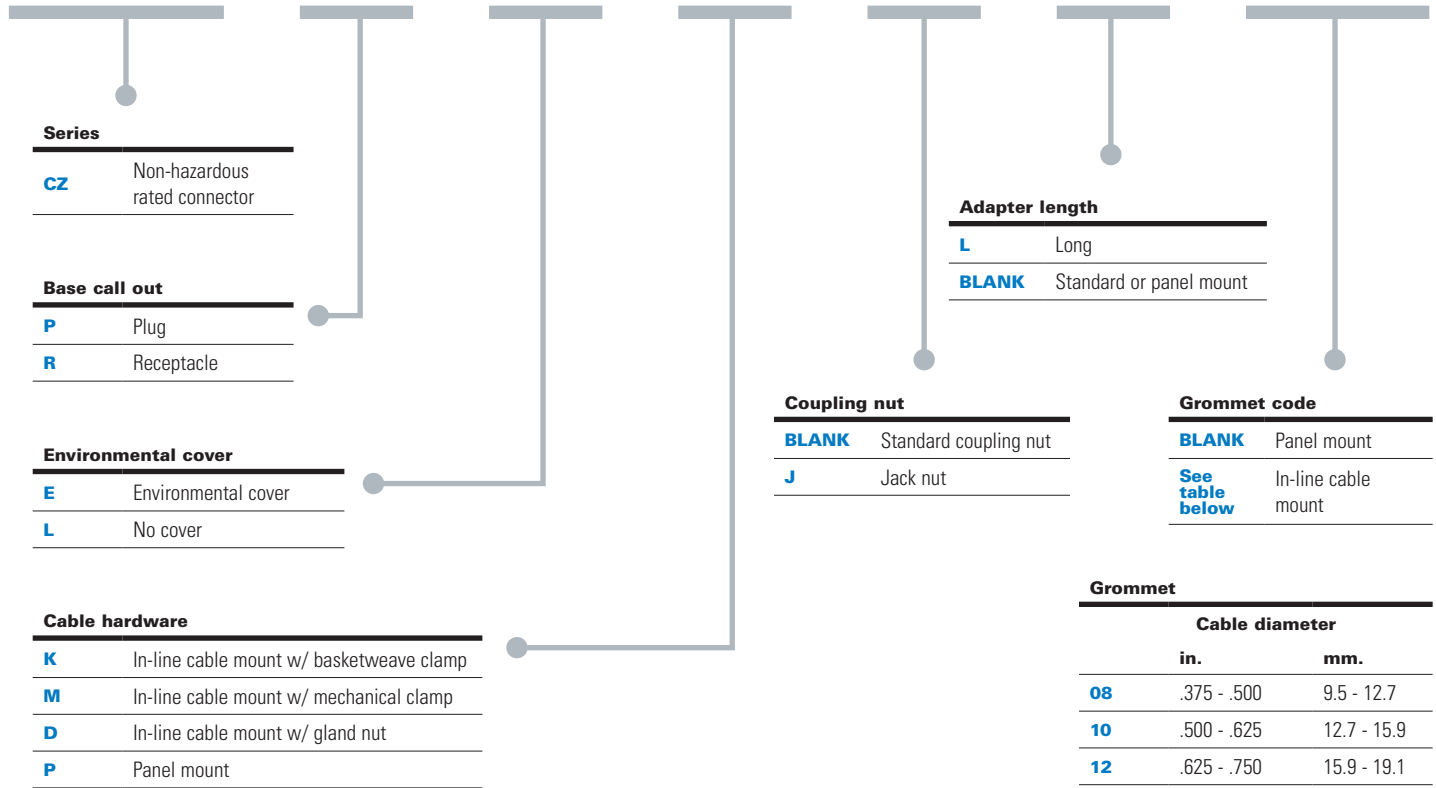

Contact amperage ratings

Contact size (AWG / MCM)	Non-circuit breaking current rating*
16 AWG	18
12 AWG	30
10 AWG	40
8 AWG	55
4 AWG	95

* Cable current rating must meet or exceed the ratings of the contacts to utilize connector at fully rated current.

NEC service voltage ratings

Service voltage	Non-circuit breaking	
	DC volts RMS	Circuit breaking AC volts RMS
A	250	240
D	600	600
E	600	600
B	600	600

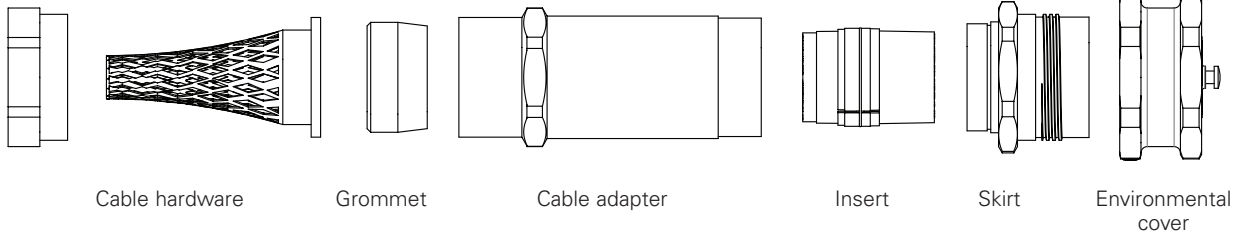

16

381

P

N

Shell size

16 Connector shell size

Contact gender

P Male pin
S Female socket

Key position

BLANK 0 degrees

See appendix p. 68 for locking options

Contact connection type

N Crimp
R Pressure

Plating

BLANK Silver (crimp or solder)
Nickel (pressure)
K Gold (crimp only)

Insert configuration

See all configurations below

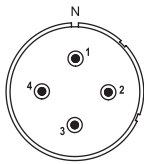

328

Contacts 4
AWG 8
Service voltage rating D

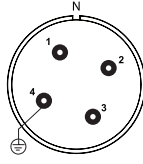

38

Contacts 4
AWG 4
Service voltage rating D

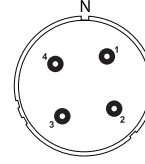

322

Contacts 4
AWG 4
Service voltage rating D

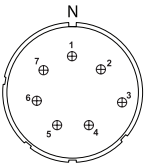

378

Contacts 7
AWG 12
Service voltage rating D

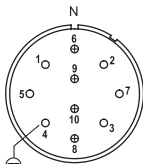

376

Contacts 6 4
AWG 12 10
Service voltage rating D

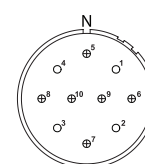

381

Contacts 6 4
AWG 12 10
Service voltage rating D

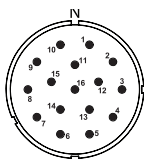

325

Contacts 16
AWG 16
Service voltage rating D

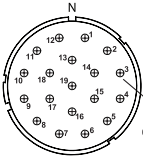

312

Contacts 19
AWG 12
Service voltage rating A

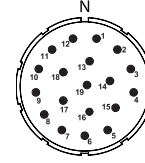

355

Contacts 19
AWG 16
Service voltage rating A

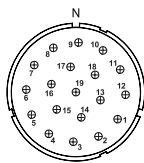

377

Contacts 19
AWG 12
Service voltage rating A

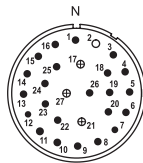

335

Contacts 24 3
AWG 16 12
Service voltage rating A

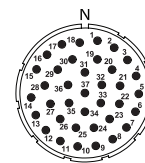

321

Contacts 37
AWG 16
Service voltage rating A

Contact Symbol	○	●	⊕	○	⦿	●	⊕	⊖	⊕	⊖	⊕	⊖
AWG	18	16	12	10	8	4	1/0	4/0	313 MCM	444 MCM	535 MCM	777 MCM

CZ series multi-pin connectors

20 Shell

Applications:

Heavy duty control and instrumentation

Certifications:

- UL recognized: UL1977
CSA: C22.2 No. 182.3
- CE marked

Environmental:

- IP68
- NEMA 4X, 6P

Ambient temperature:

- 60°C to +55°C

Construction:

- Contacts - silver plated copper, crimp or solder style; nickel plated brass, pressure style; optional gold plated (crimp only)
- Shells - high tensile strength aluminum; hard anodic coating per MIL-A-8625, Type III, olive drab color
- Rigid insulators - thermoplastic
- Resilient inserts - silicone rubber



Features & benefits:

- Intermateable with other brands
- Reversible inserts are compatible with all panel mount, in-line, male and female shells
- Exclusive visual mating alignment allows for easy installation
- Easily accessible wire terminals
- Ample wiring space within shells
- Double-lead thread coupling
- Reversible 8-point diamond cord grip relieves strain on conductors (patent pending)
- Suited for use with Type P cable
- Impact-resistant

Cable mounted receptacle with mechanical clamp

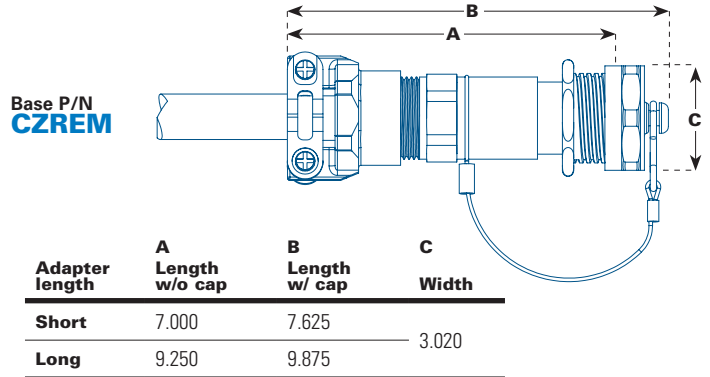

Cable mounted plug with mechanical clamp

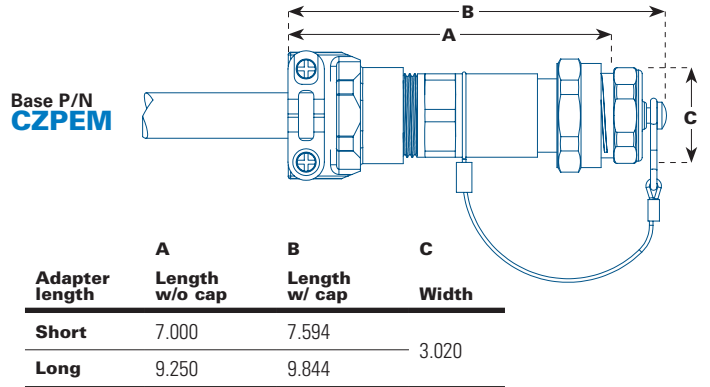

Receptacle with conduit adapter

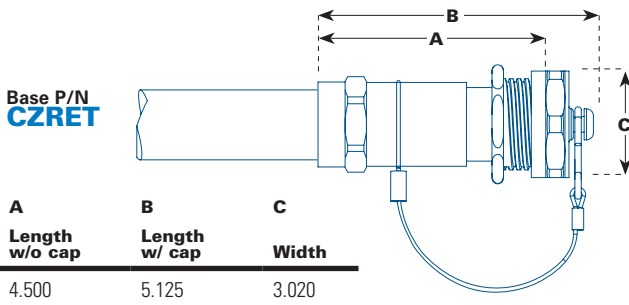

Cable mounted receptacle with gland nut

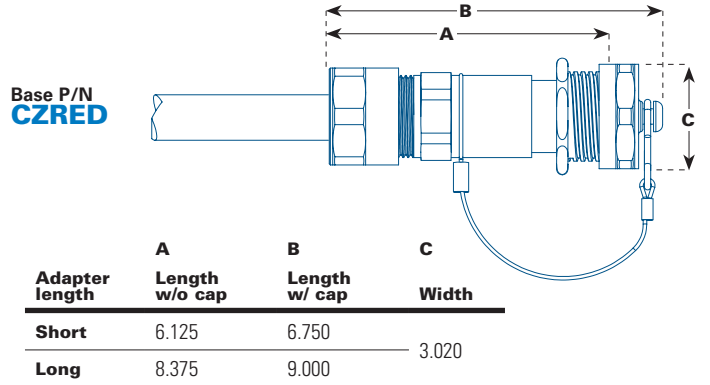

Plug with conduit adapter

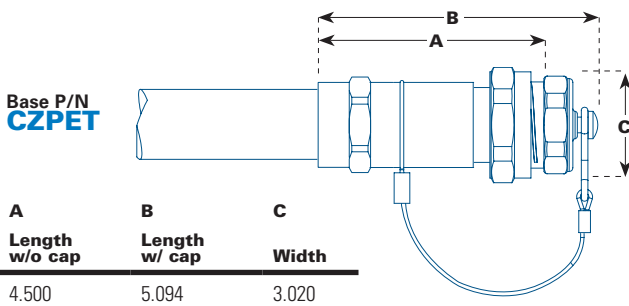

Cable mounted plug with gland nut

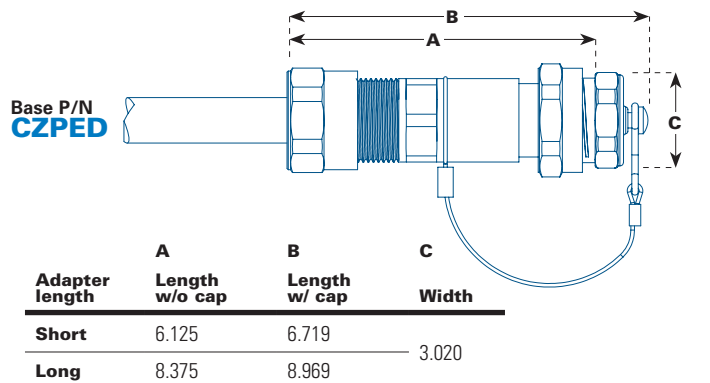

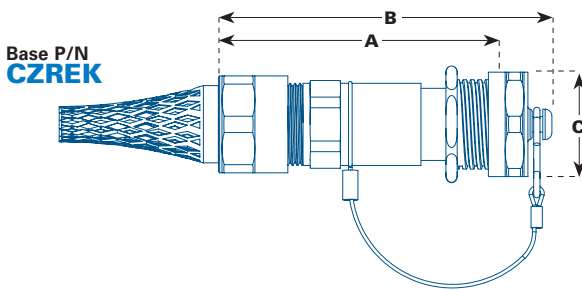

Cable mounted receptacle with basketweave

Adapter Length	A Length w/o cap	B Length w/ cap	C Width
Short	6.125	6.750	3.020
Long	8.375	9.000	

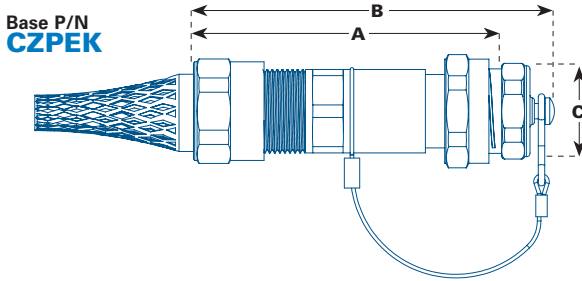

Cable mounted plug with basketweave

Adapter length	A Length w/o cap	B Length w/ cap	C Width
Short	6.125	6.719	3.020
Long	8.375	8.969	

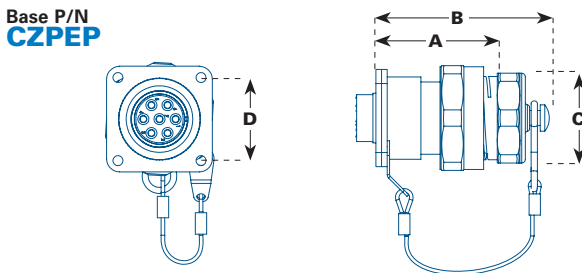

Panel mounted plug

A Length w/o cap	B Length w/ cap	C Width	D Ctr. - ctr. mount hole	Diameter Mount hole
2.438	3.031	3.020	2.094	0.277

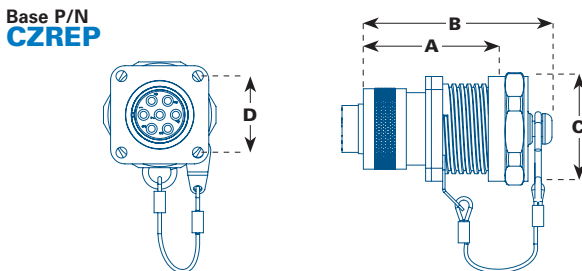

Panel mounted receptacle

A Length w/o cap	B Length w/ cap	C Width	D Ctr. - ctr. mount hole	Diameter Mount hole
2.328	2.938	2.75	2.094	0.219

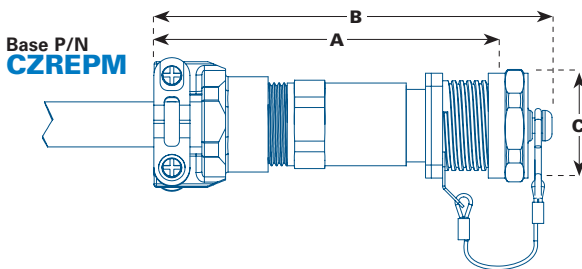

Cable mounted square flange receptacle with mechanical clamp

Adapter length	A Length w/o cap	B Length w/ cap	C Width	D Ctr. - ctr. mount hole	Diameter Mount hole
Short	7.000	7.625	2.75	2.094	0.219
Long	9.250	9.875			

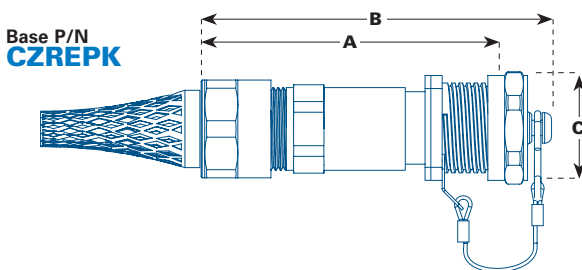

Cable mounted square flange receptacle with basketweave

Adapter length	A Length w/o cap	B Length w/ cap	C Width	D Ctr. - ctr. mount hole	Diameter Mount hole
Short	6.125	6.750	2.750	2.094	0.219
Long	8.375	9.000			

CZ series– 20 Shell

Example: CZ-PEKL-1620-376PN

CZ P E K L 16

Series

CZ Non-hazardous rated connector

Base call out

P Plug

R Receptacle

Environmental cover

E Environmental cover

L No cover

Cable hardware

K In-line cable mount w/ basketweave clamp

M In-line cable mount w/ mechanical clamp

D In-line cable mount w/ gland nut

P Panel mount

Adapter length

L Long

BLANK Standard or panel mount

Coupling nut

BLANK Standard coupling nut

J Jack nut

Grommet code

BLANK Panel mount

See table below In-line cable mount

Grommet

	Cable diameter	
	in.	mm.
10	0.500 - 0.625	12.7 - 15.9
12	0.625 - 0.750	15.9 - 19.1
14	0.750 - 0.875	19.1 - 22.2
16	0.875 - 1.000	22.2 - 25.4
18	1.000 - 1.125	25.4 - 28.6
20	1.125 - 1.250	28.6 - 31.8
22	1.250 - 1.375	31.8 - 34.9
24	1.375 - 1.500	34.9 - 38.1
26	1.500 - 1.625	38.1 - 41.3

Contact amperage ratings

Contact size (AWG / MCM)	Non-circuit breaking current rating*
16 AWG	18
12 AWG	30
10 AWG	40
8 AWG	55
4 AWG	95
1/0 AWG	155

* Cable current rating must meet or exceed the ratings of the contacts to utilize connector at fully rated current.

NEC service voltage ratings

Service voltage	Non-circuit breaking	
	DC volts RMS	Circuit breaking AC volts RMS
A	250	240
D	600	600
E	600	600
B	600	600

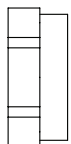

Cable hardware

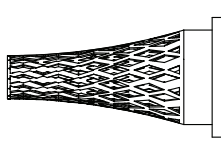

Grommet



Cable adapter

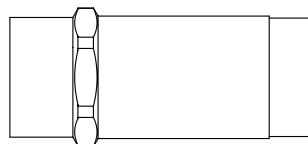

Insert

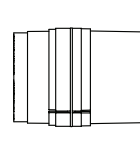

Skirt

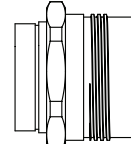

Environmental cover

20

376

P

N

Shell size

20	Connector shell size
C20	C length shell size

Contact gender

P	Male pin
S	Female socket

Key position

BLANK	0 degrees
<i>See appendix p. 69 for locking options</i>	

Insert configuration

See all configurations below

Contact connection type

N	Crimp
R	Pressure

Plating

BLANK	Silver (crimp or solder) Nickel (pressure)
K	Gold (crimp only)

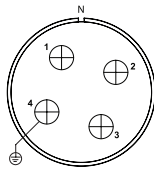

40

# Contacts	4
AWG	1/0
Service voltage rating	D

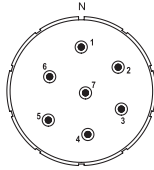

359*

# Contacts	7
AWG	8
Service voltage rating	E

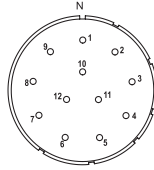

375

# Contacts	12
AWG	10
Service voltage rating	D

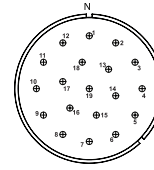

376

# Contacts	19
AWG	12
Service voltage rating	D

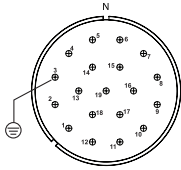

388

# Contacts	19
AWG	12
Service voltage rating	D

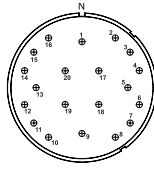

332

# Contacts	20
AWG	12
Service voltage rating	B Center A Outer

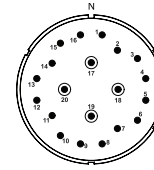

334

# Contacts	16 4
AWG	16 8
Service voltage rating	D

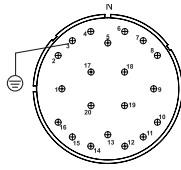

387

# Contacts	20
AWG	12
Service voltage rating	B Center A Outer

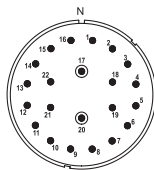

331*

# Contacts	20 2
AWG	16 8
Service voltage rating	D (16 AWG) E (8 AWG)

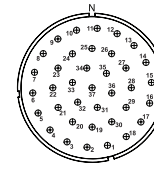

386

# Contacts	37
AWG	12
Service voltage rating	A

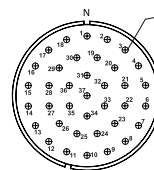

350

# Contacts	37
AWG	12
Service voltage rating	A

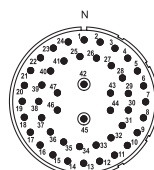

354*

# Contacts	45 2
AWG	16 8
Service voltage rating	D (8 AWG) A (16 AWG)

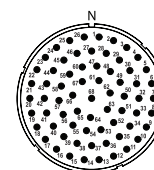

313

# Contacts	68
AWG	16
Service voltage rating	A

***Made to order item. Consult factory for availability and lead time.**

Contact Symbol	○	●	⊕	○	⊙	●	⊕	⊖	⊕	⊖	⊕	⊖
AWG	18	16	12	10	8	4	1/0	4/0	313 MCM	444 MCM	535 MCM	777 MCM

CZ series multi-pin connectors

24 Shell



Applications:

Heavy duty control and instrumentation

Certifications:

- UL recognized: UL1977
CSA: C22.2 No. 182.3

- CE marked

Environmental:

- IP68
- NEMA 4X, 6P

Ambient temperature:

- 60°C to +55°C

Construction:

- Contacts - silver plated copper, crimp or solder style; nickel plated brass, pressure style; optional gold plated (crimp only)
- Shells - high tensile strength aluminum; hard anodic coating per MIL-A-8625, Type III, olive drab color
- Rigid insulators - thermoplastic
- Resilient inserts - silicone rubber

Features & benefits:

- Intermateable with other brands
- Reversible inserts are compatible with all panel mount, in-line, male and female shells
- Exclusive visual mating alignment allows for easy installation
- Easily accessible wire terminals
- Ample wiring space within shells
- Double-lead thread coupling
- Reversible 8-point diamond cord grip relieves strain on conductors (patent pending)
- Suited for use with Type P cable
- Impact-resistant

Cable mounted receptacle with mechanical clamp

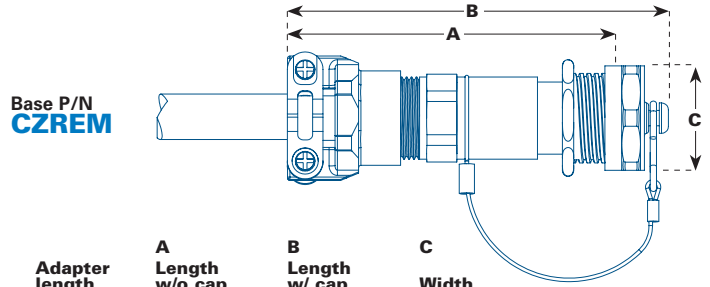

Adapter length	A Length w/o cap	B Length w/ cap	C Width
Short	7.562	8.188	3.563
Long	9.813	10.438	

Cable mounted plug with mechanical clamp

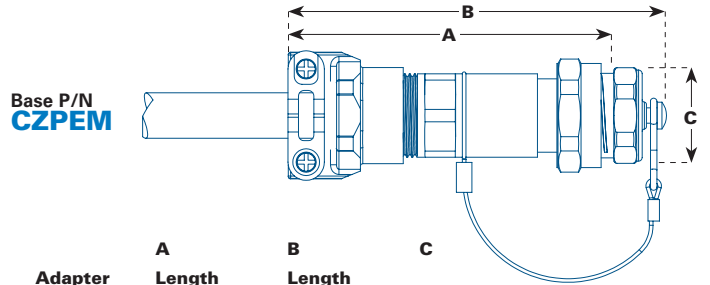

Adapter length	A Length w/o cap	B Length w/ cap	C Width
Short	7.563	8.156	3.600
Long	9.813	10.406	

Receptacle with conduit adapter

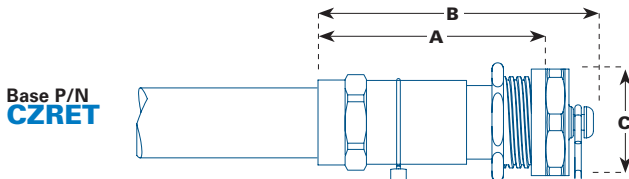

A Length w/o cap	B Length w/ cap	C Width
4.625	5.250	3.563

Cable mounted receptacle with gland nut

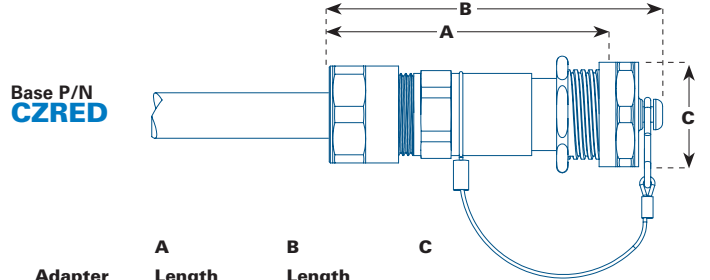

Adapter length	A Length w/o cap	B Length w/ cap	C Width
Short	6.625	7.250	3.563
Long	8.875	9.500	

Plug with conduit adapter

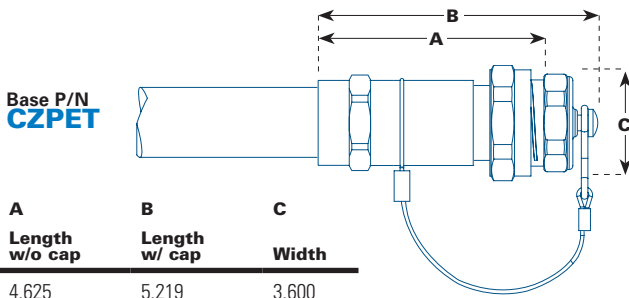

A Length w/o cap	B Length w/ cap	C Width
4.625	5.219	3.600

Cable mounted plug with gland nut

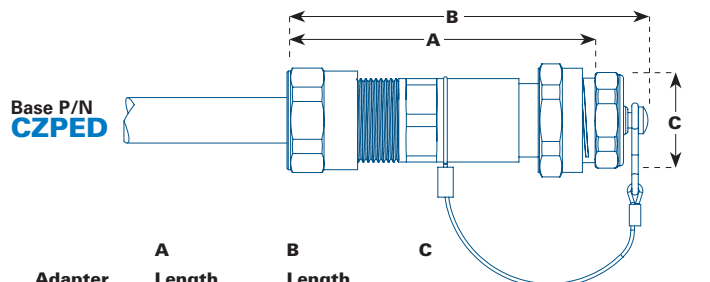

Adapter length	A Length w/o cap	B Length w/ cap	C Width
Short	6.625	7.219	3.600
Long	8.875	9.469	

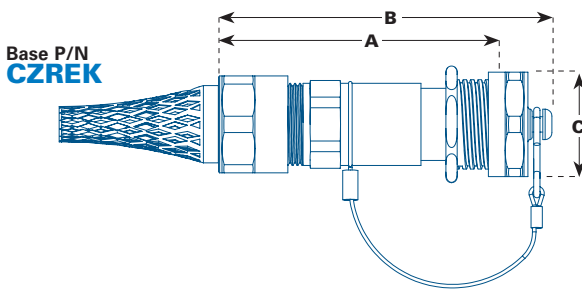

Cable mounted receptacle with basketweave

Adapter length	A Length w/o cap	B Length w/ cap	C Width
Short	6.625	7.250	3.563
Long	8.875	9.500	

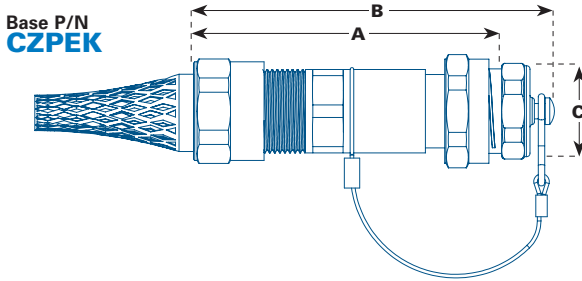

Cable mounted plug with basketweave

Adapter length	A Length w/o cap	B Length w/ cap	C Width
Short	6.625	7.219	3.600
Long	8.875	9.469	

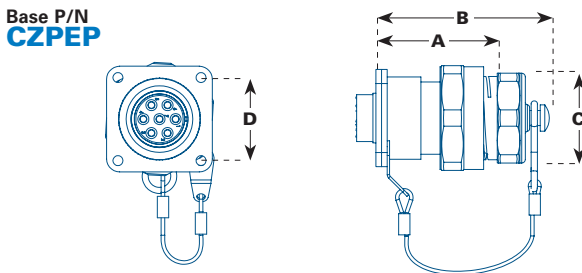

Panel mounted plug

A Length w/o cap	B Length w/ cap	C Width	D Ctr. - ctr. mount hole	Diameter Mount hole
2.469	3.063	3.600	2.531	0.344

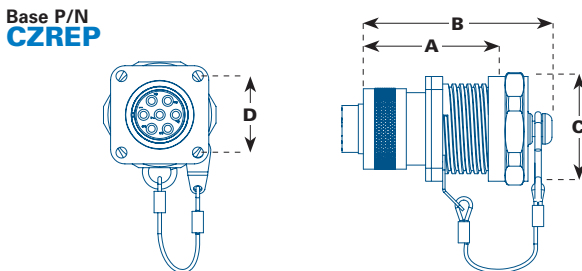

Panel mounted receptacle

A Length w/o cap	B Length w/ cap	C Width	D Ctr. - ctr. mount hole	Diameter Mount hole
2.328	2.938	3.250	2.531	0.281

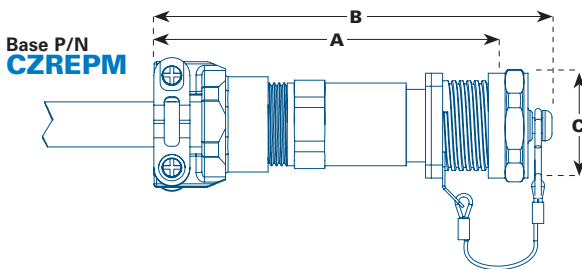

Cable mounted square flange receptacle with mechanical clamp

Adapter length	A Length w/o cap	B Length w/ cap	C Width	D Ctr. - ctr. mount hole	Diameter Mount hole
Short	7.563	8.188	3.250	2.531	0.281
Long	9.813	10.438			

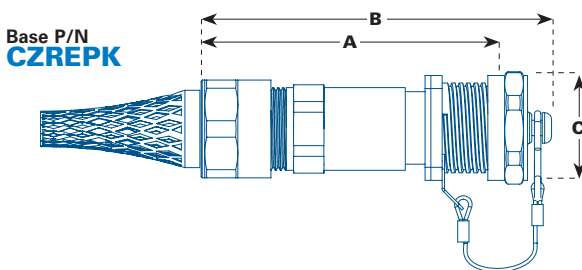

Cable mounted square flange receptacle with basketweave

Adapter length	A Length w/o cap	B Length w/ cap	C Width	D Ctr. - ctr. mount hole	Diameter Mount hole
Short	6.625	7.250	3.250	2.531	0.281
Long	8.875	9.500			

CZ series– 24 Shell

Example: CZ-PEKL-1624-371PN

CZ P E K L 16

Series

CZ Non-hazardous rated connector

Base call out

P Plug

R Receptacle

Environmental cover

E Environmental cover

L No cover

Cable hardware

K In-line cable mount w/ basketweave clamp

M In-line cable mount w/ mechanical clamp

D In-line cable mount w/ gland nut

P Panel mount

Adapter length

L Long

BLANK Standard or panel mount

Coupling nut

BLANK Standard coupling nut

J Jack nut

Grommet code

BLANK Panel mount

See table below In-line cable mount

Grommet

	Cable diameter	
	in.	mm.
16	0.875 - 1.000	22.2 - 25.4
18	1.000 - 1.125	25.4 - 28.6
20	1.125 - 1.250	28.6 - 31.8
22	1.250 - 1.375	31.8 - 34.9
24	1.375 - 1.500	34.9 - 38.1
26	1.500 - 1.625	38.1 - 41.2
28	1.625 - 1.750	41.2 - 44.4
30	1.750 - 1.875	44.4 - 47.6

Contact amperage ratings

Contact size (AWG / MCM)	Non-circuit breaking current rating*
16 AWG	18
12 AWG	30
1/0 AWG	155
4/0 AWG	225

* Cable current rating must meet or exceed the ratings of the contacts to utilize connector at fully rated current.

NEC service voltage ratings

Service voltage	Non-circuit breaking	Circuit breaking
	DC volts RMS	AC volts RMS
A	250	240
D	600	600
E	600	600
B	600	600

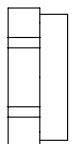

Cable hardware

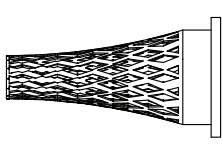

Grommet



Cable adapter

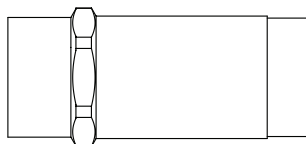

Insert

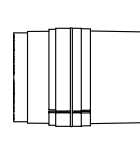

Skirt

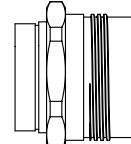

Environmental cover

24 371 P N

Shell size

24	Connector shell size
C24	C length shell size

Contact gender

P	Male pin
S	Female socket

Key position

BLANK	0 degrees
<i>See appendix p. 70 for locking options</i>	

Contact connection type

N	Crimp
R	Pressure

Plating

BLANK	Silver (crimp or solder) Nickel (pressure)
K	Gold (crimp only)

Insert configuration

See all configurations below

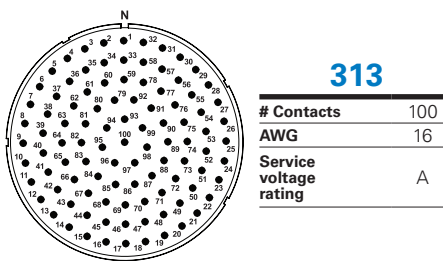
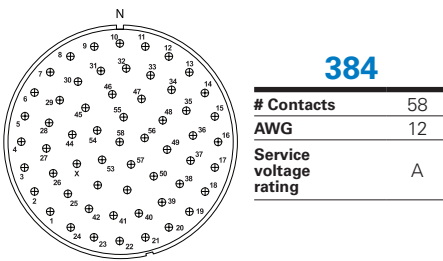
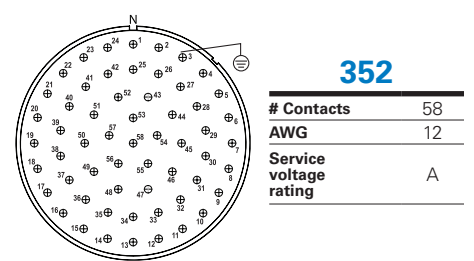
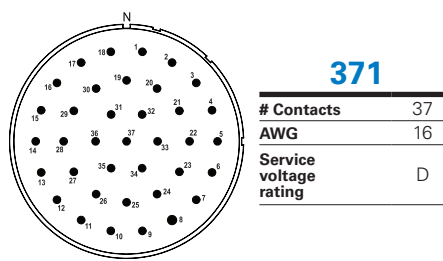
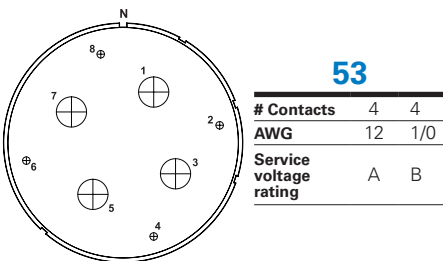
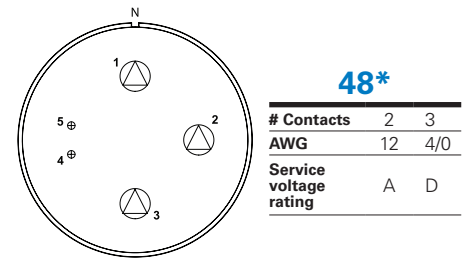
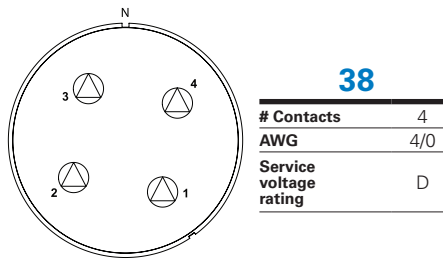
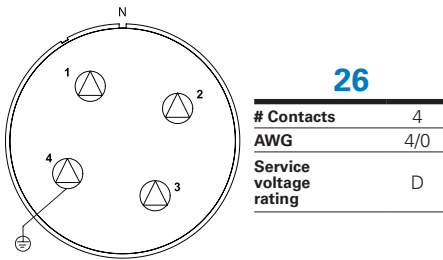

***Made to order item. Consult factory for availability and lead time.**

Contact Symbol	○	●	⊕	○	⦿	●	⊕	⊖	⊗	⊙	⊗	
AWG	18	16	12	10	8	4	1/0	4/0	313 MCM	444 MCM	535 MCM	777 MCM

CZ series multi-pin connectors

28 Shell

Applications:

Heavy duty control and instrumentation

Certifications:

- UL recognized: UL1977
CSA: C22.2 No. 182.3
- CE marked

Environmental:

- IP68
- NEMA 4X, 6P

Ambient temperature:

- -60°C to +55°C

Construction:

- Contacts - silver plated copper, crimp or solder style; nickel plated brass, pressure style; optional gold plated (crimp only)
- Shells - high tensile strength aluminum; hard anodic coating per MIL-A-8625, Type III, olive drab color
- Rigid insulators - thermoplastic
- Resilient inserts - silicone rubber



Features & benefits:

- Intermateable with other brands
- Reversible inserts are compatible with all panel mount, in-line, male and female shells
- Exclusive visual mating alignment allows for easy installation
- Easily accessible wire terminals
- Ample wiring space within shells
- Double-lead thread coupling
- Reversible 8-point diamond cord grip relieves strain on conductors (patent pending)
- Suited for use with Type P cable
- Impact-resistant

Cable mounted receptacle with mechanical clamp

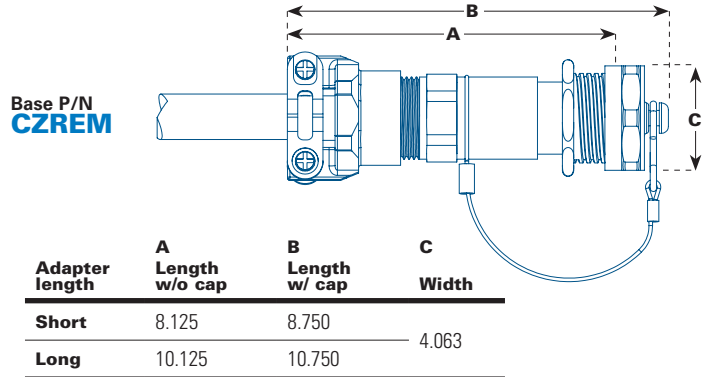

Cable mounted plug with mechanical clamp

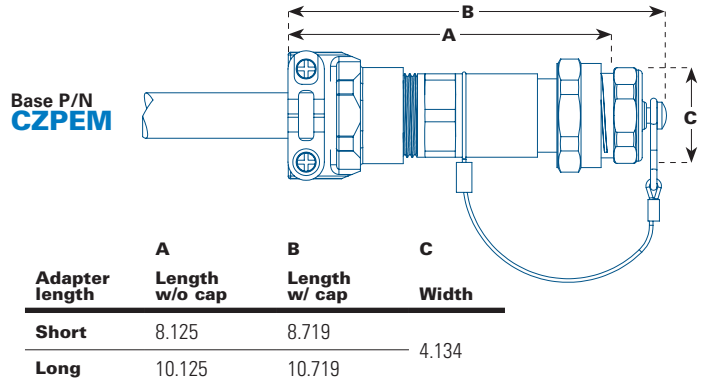

Receptacle with conduit adapter

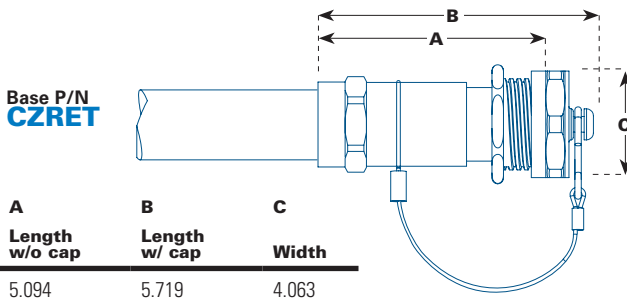

Cable mounted receptacle with gland nut

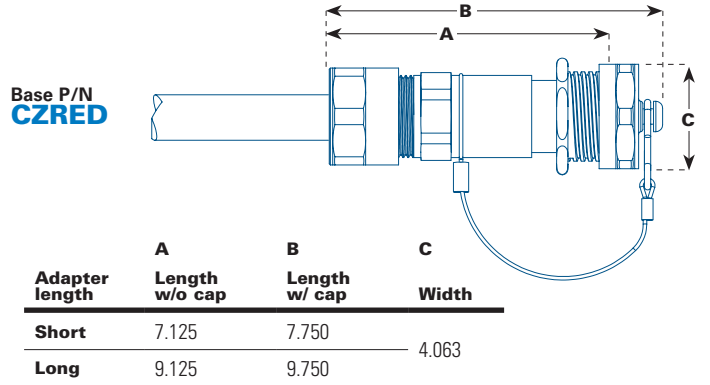

Plug with conduit adapter

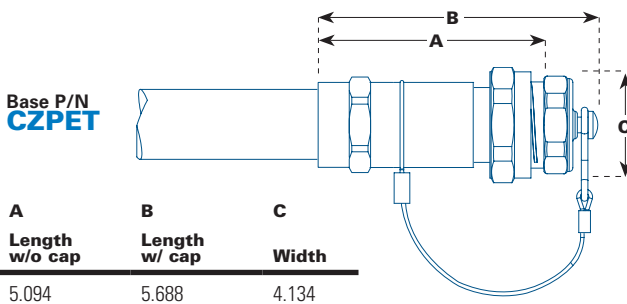

Cable mounted plug with gland nut

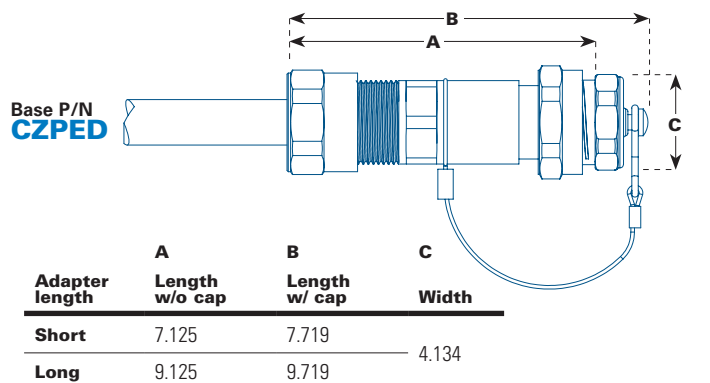

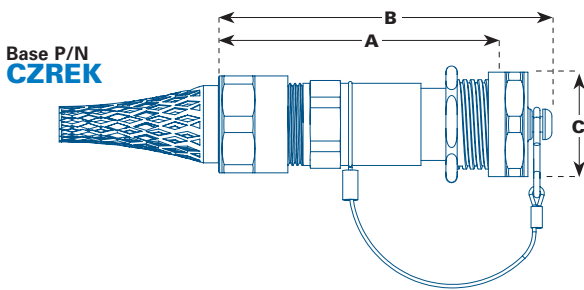

Cable mounted receptacle with basketweave

Adapter length	A Length w/o cap	B Length w/ cap	C Width
Short	7.125	7.750	4.063
Long	9.125	9.750	

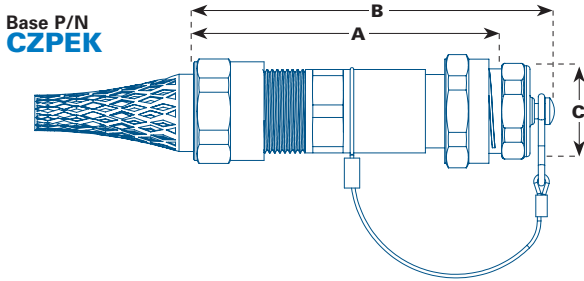

Cable mounted plug with basketweave

Adapter length	A Length w/o cap	B Length w/ cap	C Width
Short	7.125	7.719	4.134
Long	9.125	9.719	

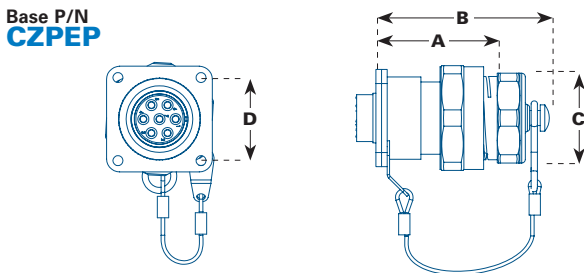

Panel mounted plug

A Length w/o cap	B Length w/ cap	C Width	D Ctr. - ctr. mount hole	Diameter Mount hole
2.469	3.063	4.134	3.031	0.344

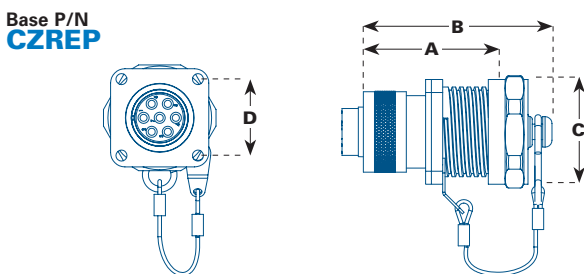

Panel mounted receptacle

A Length w/o cap	B Length w/ cap	C Width	D Ctr. - ctr. mount hole	Diameter Mount hole
2.328	2.938	3.750	3.031	0.344

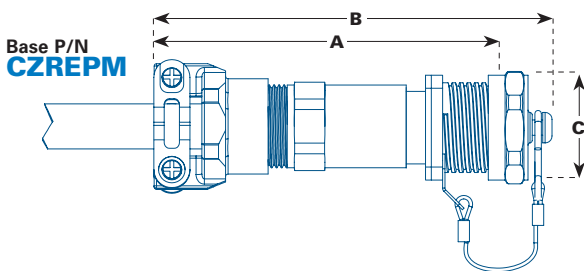

Cable mounted square flange receptacle with mechanical clamp

Adapter length	A Length w/o cap	B Length w/ cap	C Width	D Ctr. - ctr. mount hole	Diameter Mount hole
Short	8.125	8.750	3.750	3.031	0.344
Long	10.125	10.750			

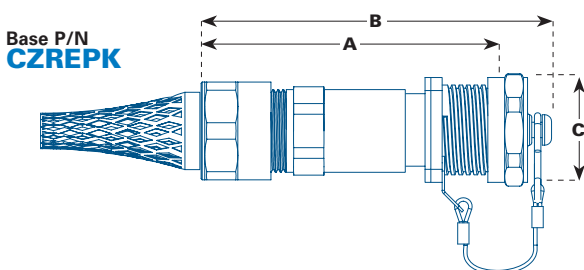

Cable mounted square flange receptacle with basketweave

Adapter length	A Length w/o cap	B Length w/ cap	C Width	D Ctr. - ctr. mount hole	Diameter Mount hole
Short	7.125	7.750	3.750	3.031	0.344
Long	9.125	9.750			

CZ series– 28 Shell

Example: CZ-PEKL-2428-339PN

CZ P E K L 24

Series

CZ Non-hazardous rated connector

Base call out

P Plug

R Receptacle

Environmental cover

E Environmental cover

L No cover

Cable hardware

K In-line cable mount w/ basketweave clamp

M In-line cable mount w/ mechanical clamp

D In-line cable mount w/ gland nut

P Panel mount

Adapter length

L Long

BLANK Standard or panel mount

Coupling nut

BLANK Standard coupling nut

J Jack nut

Grommet code

BLANK Panel mount

See table below In-line cable mount

Grommet

Cable diameter

	in.	mm.
24	1.375 - 1.500	34.9 - 38.1
26	1.500 - 1.625	38.1 - 41.3
28	1.625 - 1.750	41.3 - 44.5
30	1.750 - 1.875	44.5 - 47.6
32	1.875 - 2.000	47.6 - 50.8
34	2.000 - 2.125	50.8 - 54.0
36	2.125 - 2.250	54.0 - 57.2
38	2.250 - 2.375	57.2 - 60.3
40	2.375 - 2.500	60.3 - 63.5
42	2.500 - 2.625	63.5 - 66.7
44	2.625 - 2.750	66.7 - 69.9
46	2.750 - 2.875	69.9 - 73.0

Contact amperage ratings

Contact size (AWG / MCM)	Non-circuit breaking current rating*
12 AWG	30
10 AWG	40
8 AWG	55
4/0 AWG	225
350 MCM	325

* Cable current rating must meet or exceed the ratings of the contacts to utilize connector at fully rated current.

NEC service voltage ratings

Service voltage	Non-circuit breaking	Circuit breaking
	DC volts RMS	AC volts RMS
A	250	240
D	600	600
E	600	600
B	600	600

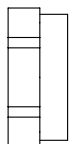

Cable hardware

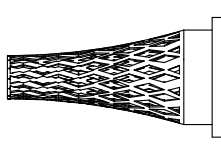

Grommet

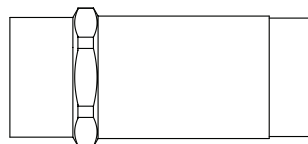

Cable adapter

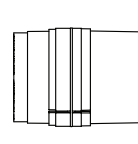

Insert

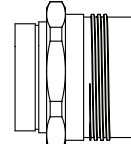

Skirt

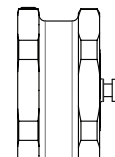

Environmental cover

28

339

P

N

Shell size

28	Connector shell size
C28	C length shell size

Contact gender

P	Male pin
S	Female socket

Key position

BLANK	0 degrees
<i>See appendix p. 71 for locking options</i>	

Contact connection type

BLANK	Solder
N	Crimp

Plating

BLANK	Silver (crimp or solder) Nickel (pressure)
K	Gold (crimp only)

Insert configuration

See all configurations below

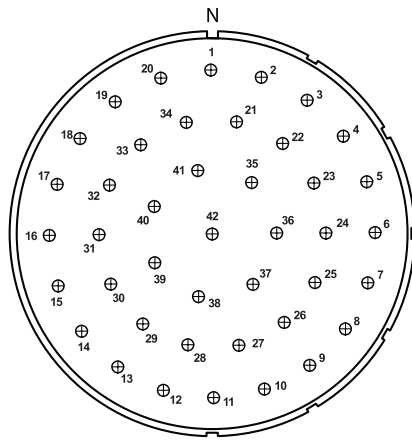

339

# Contacts	42
AWG	12
Service voltage rating	D

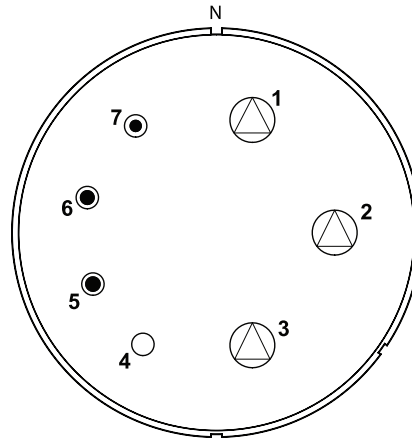

H44 (V.F.D. insert)

# Contacts	3	3	1
AWG	4/0	8	10
Service voltage rating	D		

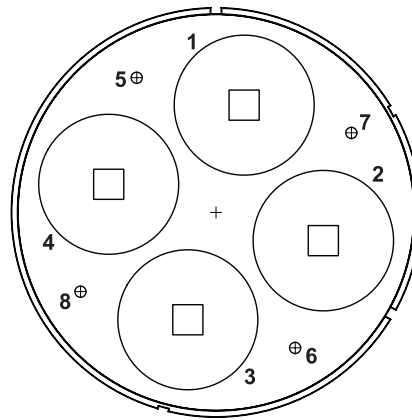

43

# Contacts	4	4
AWG	12	350 MCM
Service voltage rating	D (350 MCM)	E (12 AWG)

Contact Symbol	○	●	⊕	○	⊙	●	⊕	⊖	⊕	⊖	⊕	⊖	⊕	⊖
AWG	18	16	12	10	8	4	1/0	4/0	313 MCM	350 MCM	444 MCM	535 MCM	777 MCM	

C24 Shell

Applications:

Heavy duty single pole power

Certifications:

- UL recognized: UL486A-486B
CSA: C22.2 No. 65-13
- CE marked

Ambient temperature:

- -60°C to +55°C

Environmental:

- IP68
- NEMA 4X, 6P

Construction:

- Contacts - silver plated copper, multi-lam style
- Shells - high tensile strength aluminum; hard anodic coating per MIL-A-8625, Type III, olive drab color
- Rigid insulator - thermoplastic

Features & benefits:

- Intermateable with other brands
- Exclusive visual mating alignment allows for easy installation
- Easily accessible wire terminals
- Ample wiring space within shells
- Multi-lam contacts standard on single pole connectors
 - Reduced insertion and removal forces
 - Improved resistance/heat rise performance
- Double-lead thread coupling
- Reversible 8-point diamond cord grip relieves strain on conductors (patent pending)
- Suited for use with Type P cable
- Impact-resistant
- Colored shells available for phase marking identification



Cable mounted receptacle with mechanical clamp

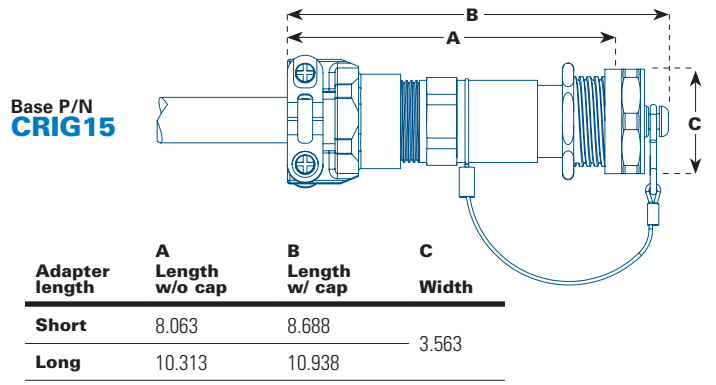

Cable mounted plug with mechanical clamp

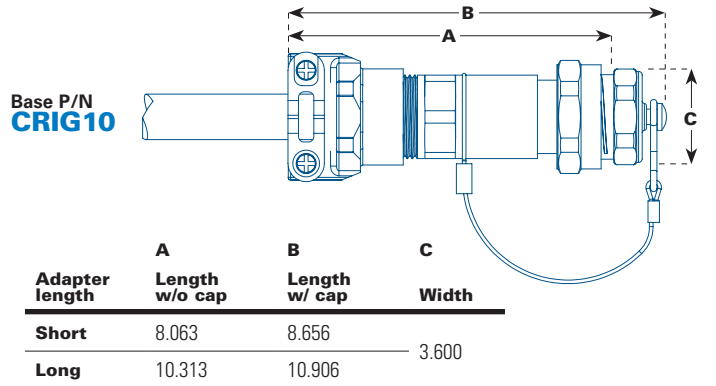

Cable mounted receptacle with gland nut

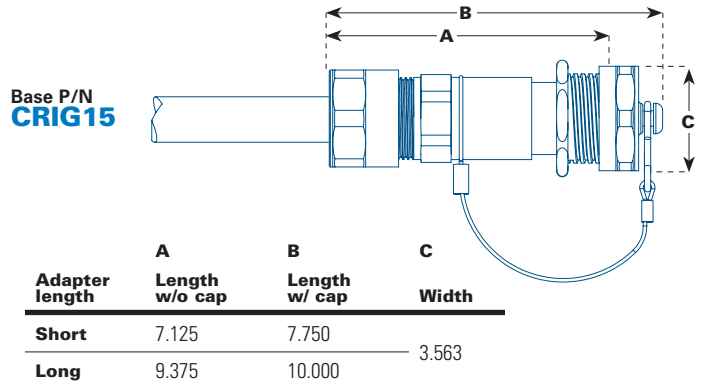

Cable mounted plug with gland nut

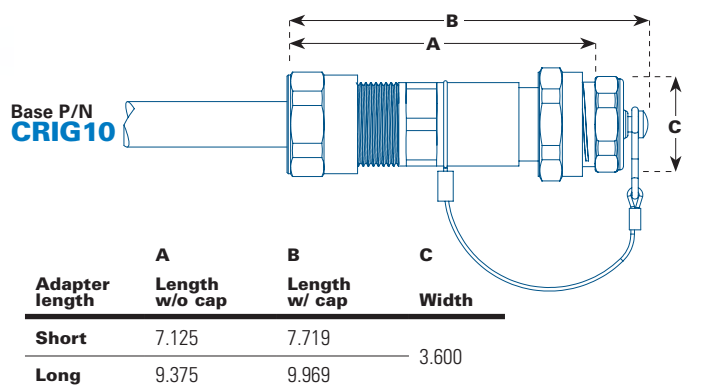

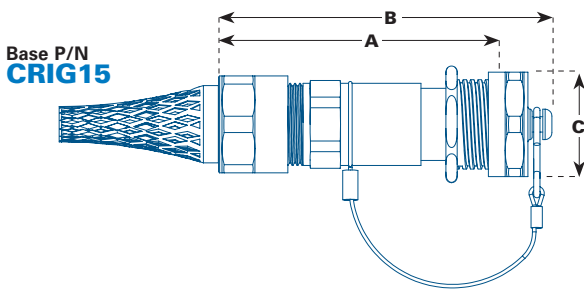

Cable mounted receptacle with basketweave

Adapter length	A Length w/o cap	B Length w/ cap	C Width
Short	7.125	7.750	3.563
Long	9.375	10.000	

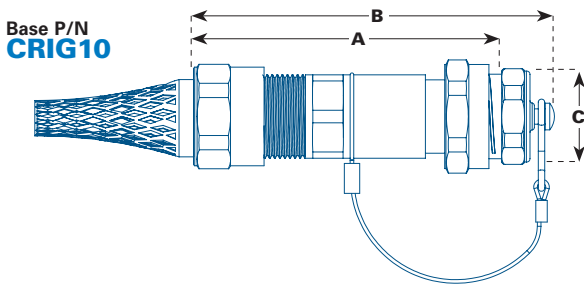

Cable mounted plug with basketweave

Adapter length	A Length w/o cap	B Length w/ cap	C Width
Short	7.125	7.719	3.600
Long	9.375	9.969	

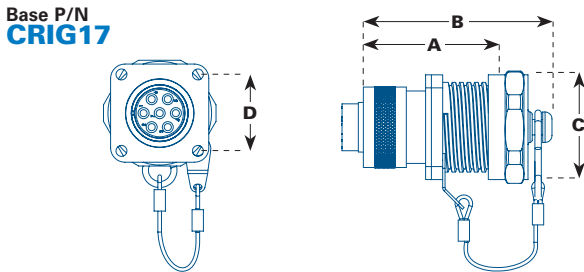

Panel mounted receptacle

A Length w/o cap	B Length w/ cap	C Width	D Ctr. - ctr. mount hole	Diameter Mount hole
2.828	3.438	3.250	2.531	0.281

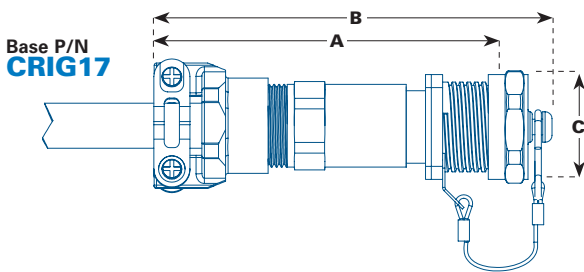

Cable mounted square flange receptacle with mechanical clamp

Adapter length	A Length w/o cap	B Length w/ cap	C Width	D Ctr. - ctr. mount hole	Diameter Mount hole
Short	8.063	8.688	3.250	2.531	0.281
Long	10.313	10.938			

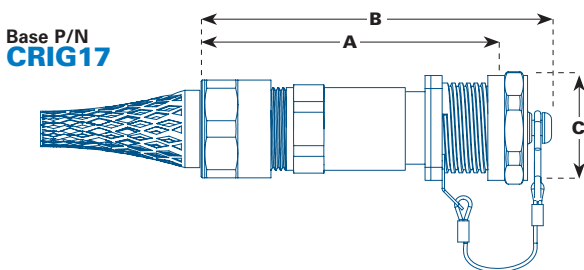

Cable mounted square flange receptacle with basketweave

Adapter length	A Length w/o cap	B Length w/ cap	C Width	D Ctr. - ctr. mount hole	Diameter Mount hole
Short	7.125	7.750	3.250	2.531	0.281
Long	9.375	10.000			

CRIG single pole series– C24 Shell

Example: **CRIG10P724MBL**

CRIG

10

P

Series

CRIG Non-hazardous rated connector

Contact type

BLANK Standard
H H Series

Base call out

10 Plug (cable mount)
15 Receptacle (cable mount)
17 Sq. flange receptacle (cable/panel mount)

Contact gender

P Dead front pin
S Socket contact

Contact amperage ratings

Contact size (AWG / MCM)	Non-circuit breaking current rating*
313 MCM	636
444 MCM	796
535 MCM	898
777 MCM	1135

* Cable current rating must meet or exceed the ratings of the contacts to utilize connector at fully rated current.

NEC service voltage ratings

Service voltage	Non-circuit breaking DC volts RMS	Circuit breaking AC volts RMS
A	250	240
D	600	600
E	600	600
B	600	600

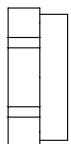

Cable hardware

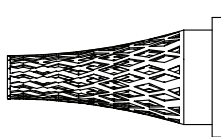

Grommet



Cable adapter

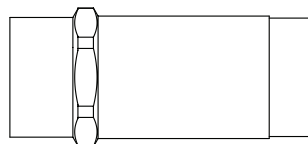

Insert

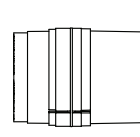

Skirt

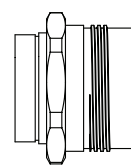

Environmental cover

7

24

M

BL

Cable size/entry

2	313 kcmil cable
4	444 kcmil cable
5	535 kcmil cable
7	646 - 777 kcmil cable
R	Panel mount - bus bar entry (connector style 17 only)
N	Panel mount - direct cable entry
<i>See all configurations below</i>	

Cable hardware

BLANK	<i>If R or N are chosen in "Cable Size/Entry" category on left</i>
K	Basketweave clamp
M	Mechanical clamp
D	Gland nut

Special color code

BLANK	No special color
BL	Blue
OR	Orange
Y	Yellow
BR	Brown
R	Red
W	White
BK	Black
G	Green

Grommet

	Cable diameter	
	in.	mm.
BLANK	<i>If R or N are chosen in "Cable Size/Entry" category above</i>	
16	0.875 - 1.000	22.2 - 25.4
18	1.000 - 1.125	25.4 - 28.6
20	1.125 - 1.250	28.6 - 31.8
22	1.250 - 1.375	31.8 - 34.9
24	1.375 - 1.500	34.9 - 38.1
26	1.500 - 1.625	38.1 - 41.2
28	1.625 - 1.750	41.2 - 44.4
30	1.750 - 1.875	44.4 - 47.6

Coupling nut

BLANK	Glove nut
ST	Standard

313

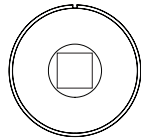

# Contacts	1
AWG	313 MCM
Service voltage rating	1000V
Current rating	636A

444

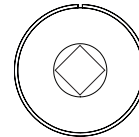

# Contacts	1
AWG	444 MCM
Service voltage rating	1000V
Current rating	796A

535

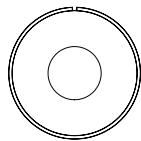

# Contacts	1
AWG	535 MCM
Service voltage rating	1000V
Current rating	898A

386

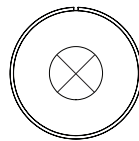

# Contacts	1
AWG	777 MCM
Service voltage rating	1000V
Current rating	1135A

Contact Symbol

	○	●	⊕	○	⊙	●	⊕	⊖	⊕	⊖	○	⊗
AWG	18	16	12	10	8	4	1/0	4/0	313 MCM	444 MCM	535 MCM	777 MCM

CEX Series

Multi-pin and single pole connectors for hazardous areas



Technical reference

Applications:

Heavy duty control and instrumentation, single pole power for hazardous areas

Certifications:

- CE marked
- AEx listed for US Ex Zone 1 Applications (ETL)
- Listed for Canada Ex Zone 1 Applications (ETL)
- ATEX Group II Category 2 certified (ETL)
- IECEx Zone 1 Certified (ETL)
- EAc Certified (Russia)
- INMETRO Certified (Brazil)

Ambient temperature rating:

- Certified for use at: -60°C to +55°C

Environmental:

- IP66, IP68
- NEMA 4X, 6P

Materials and finish:

- Contacts
 - Silver plated copper, crimp style and solder style
 - Nickel plated brass, pressure style
 - Multi-lam style contacts on single poles
 - Optional gold plated contacts (crimp only)
- Shells
 - High tensile strength aluminum; hard anodic coating per MIL-A-8625, Type III, black color
- Inserts
 - Rigid insert: thermoplastic material
 - Resilient insert: silicone rubber



Application standards

Property	Standard
Flame-proof enclosure	IEC60079-1
Increased safety	IEC60079-7
Dust ignition protection	IEC60079-31
Impact resistance	IEC60079-0
Dielectric test	IEC60079-7
Ingress	EN:60529
Contact retention	MIL STD 1344

Electrical ratings

Shell options with voltage ratings

Shell size	# of contacts	Contact size	Voltage rating
12	3 - 10	16 AWG - 10 AWG	A, D
16	4 - 37	16 AWG - 8 AWG	A, D
20	7 - 68	16 AWG - 8 AWG	A, B, D, E
24	37 - 100	16 AWG - 12 AWG	A, D
C24	1 - 4	313 MCM - 777 MCM	1000V
C28	7 - 8	12 AWG - 350 MCM	D, E

The voltage rating is specific to the contact configuration of the insert used. For individual insert voltage ratings, please reference catalog guide on pages 6-7.

NEC service voltage ratings

Service voltage	Non-circuit breaking	Circuit breaking
	DC volts RMS	AC volts RMS
A	250	240
D	600	600
E	600	600
B	600	600

Contact amperage ratings

Contact size (AWG / MCM)	Non-circuit breaking current rating @ 55°C*
16 AWG	18
12 AWG	30
10 AWG	40
8 AWG	55
4 AWG	73
1/0 AWG	130
4/0 AWG	198
313 MCM	502
350 MCM (solder)	290A (C24-43)
444 MCM	722
535 MCM	815
777 MCM	1030

Consult the N.E.C. General Wiring Guidelines, Article 310 prior to installing cable. Guidelines around wire temperature rating, ambient temperature correction factors and the number of conductors may limit the maximum amperage of the individual conductors.

* Cable current rating must meet or exceed the ratings of the contacts to utilize connector at fully rated current.

Potting compound specifications

Specifications:

The CEX product line is certified with Chico Liquid Seal, a proprietary formula that enables the customer to install product within a wide ambient temperature range (10°C to 30°C+). Typical gel times average approximately 2 hours or less, enabling quick installation (see gel times below).

Within controlled environments, Epoxies Etc. Flame retardant Epoxy Resin may also be used. (model # 50-3150 RFR with Catalyst 190 or model # 50-3149 RFRBK with Catalyst 192)

All potted CEX series product ships direct to the customer in a kit with the required amount of compound and does not require a separate compound order.



For full assembly and potting instructions please reference installation instructions (IF 1683) prior to assembly

The following CEX series product types require potting compound during installation.

CEX potted connectors: (compound ships with connector)

- CEX 17-1: panel mount adapters
- CEX 13-2/4: Plugs with the mechanical clamp or basket weave
- CEX 15-2/4: Connectors with the mechanical clamp or basketweave option

Alternative gland options can be used in place of potting compound on the plugs and connectors

CEX gland connectors: (no compound required)

- CEX 13-3: Plug with Eex d gland
- CEX 15-3: Connector with Eex d gland
- CEX 17-3: Connector with Eex d gland and square flange for a panel mount option

Chico Liquid Seal: gel time

Volume of compound poured (ml)	Gel time (hours) at specific temperatures				
	50° (10°C)	59° (15°C)	68° (20°C)	77° (25°C)	86° (30°C)
50	15.0	3.5	2.3	2.0	1.5
150	10.5	2.9	1.8	1.3	0.9
250	6.9	2.1	1.3	0.4	0.6

Chico Liquid Seal: energize time

Volume of compound poured (ml)	Energize time (hours) at specific temperatures				
	50° (10°C)	59° (15°C)	68° (20°C)	77° (25°C)	86° (30°C)
50	48.0	36.0	24.0	18.0	10.0
150	45.0	33.0	20.0	16.0	6.0
250	39.0	28.0	14.0	10.0	5.0

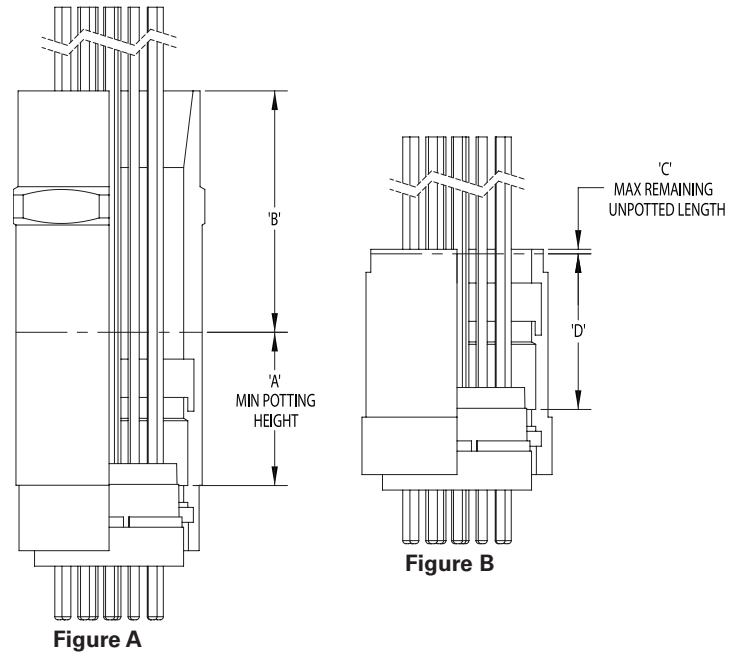

Potting compound fill rates:

Cable adapter potting (Figure A)

Shell size	Minimum potting height "A"	Maximum unpotted length "B"	Minimum volume (ml)
12	1.7" (42.2 cm)	1.4" (35.6 cm)	33.0
16	1.7" (42.2 cm)	3.4" (86.4 cm)	63.0
20	1.7" (42.2 cm)	3.4" (86.4 cm)	102.0
24	1.7" (42.2 cm)	3.4" (86.4 cm)	181.0
28	1.7" (42.2 cm)	3.4" (86.4 cm)	209.0

Panel mount potting (Figure B)

Shell size	Minimum potting height "D"	Maximum unpotted length "C"	Minimum volume (ml)
12	1.7" (42.2 cm)	0.375" (9.5 cm)	33.0
16	1.7" (42.2 cm)	0.375" (9.5 cm)	63.0
20	1.7" (42.2 cm)	0.375" (9.5 cm)	102.0
24	1.7" (42.2 cm)	0.375" (9.5 cm)	181.0
28	1.7" (42.2 cm)	0.375" (9.5 cm)	209.0



12 Shell

Applications:

Hazardous location control and instrumentation

Certifications:

- CE marked
- AEx listed for US Ex Zone 1 Applications (ETL)
- Listed for Canada Ex Zone 1 Applications (ETL)
- ATEX Group II Category 2 certified (ETL)
- IECEx Zone 1 Certified (ETL)
- EAc Certified (Russia)
- INMETRO Certified (Brazil)

Ambient temperature rating:

- Certified for use at: -60°C to +55°C

Environmental:

- IP66, IP68
- NEMA 4X, 6P

Construction:

- Contacts - silver plated copper, crimp or solder style; nickel plated brass, pressure style; optional gold plated (crimp only)
- Shells - high tensile strength aluminum; hard anodic coating per MIL-A-8625, Type III, black color
- Rigid insulators - thermoplastic
- Resilient inserts - silicone rubber

Features & benefits:

- Reversible inserts are compatible with all panel mount, in-line, male and female shells
- Exclusive visual mating alignment
- Easily accessible wire terminals
- Ample wiring space within shells
- Reversible 8-point diamond cord grip relieves strain on conductors (patent pending)
- Suited for use with Type P cable
- EX cable glands available through Crouse-Hinds
- Hexagon shell design with easy wrenching surfaces ensures adequate torquing
- Impact-resistant



Cable mounted plug with mechanical clamp

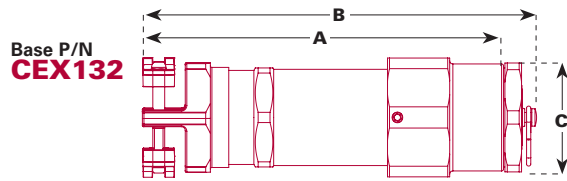

A	B	C
Length w/o cap	Length w/ cap	Width
7.14	8.00	1.75

Cable mounted plug with EX cable gland

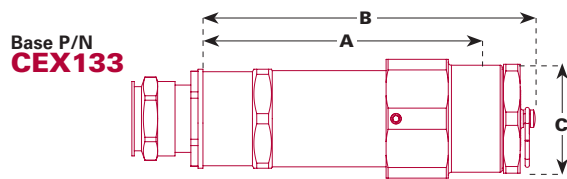

A	B	C
Length w/o cap	Length w/ cap	Width
5.71	6.57	1.75

Cable mounted plug with basketweave

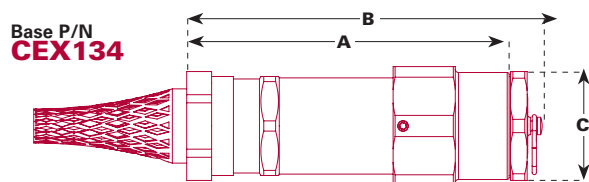

A	B	C
Length w/o cap	Length w/ cap	Width
6.18	7.04	1.75

Cable mounted receptacle with mechanical clamp

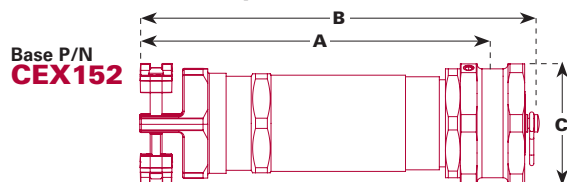

A	B	C
Length w/o cap	Length w/ cap	Width
7.50	8.13	2.00

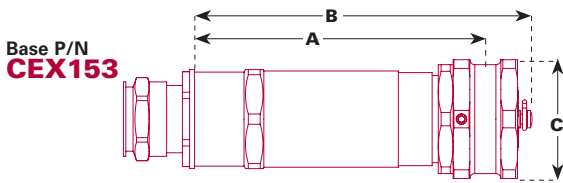

Cable mounted receptacle with EX cable gland

A	B	C
Length w/o cap	Length w/ cap	Width
6.08	6.71	2.00

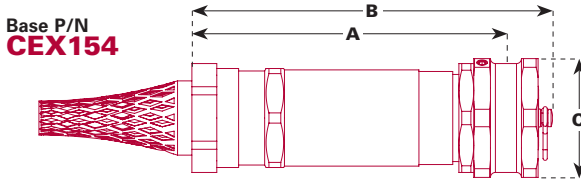

Cable mounted receptacle with basketweave

A	B	C
Length w/o cap	Length w/ cap	Width
6.54	7.17	2.00

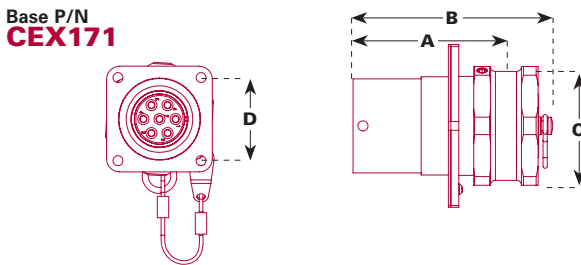

Panel mounted receptacle

A	B	C	D	Diameter
Length w/o cap	Length w/ cap	Width	Ctr. - ctr. mount hole	Mount hole
4.89	5.52	2.00	1.65	0.22

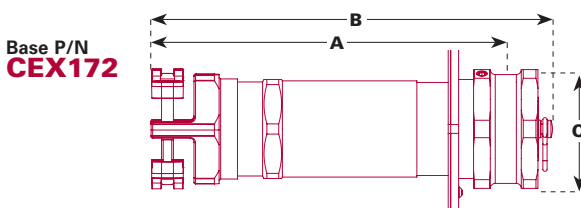

Cable mounted square flange receptacle with mechanical clamp

A	B	C	D	Diameter
Length w/o cap	Length w/ cap	Width	Ctr. - ctr. mount hole	Mount hole
7.50	8.13	2.00	1.65	0.22

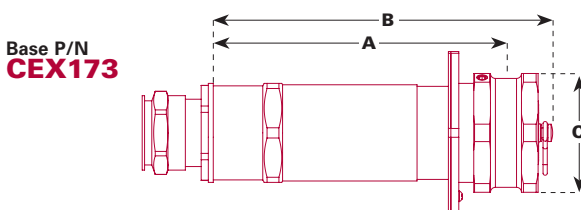

Cable mounted square flange receptacle with EX cable gland

A	B	C	D	Diameter
Length w/o cap	Length w/ cap	Width	Ctr. - ctr. mount hole	Mount hole
6.08	6.71	2.00	1.65	0.22

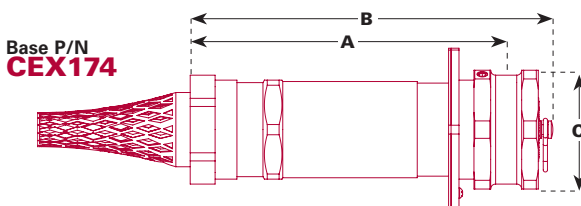

Cable mounted square flange receptacle with basketweave

A	B	C	D	Diameter
Length w/o cap	Length w/ cap	Width	Ctr. - ctr. mount hole	Mount hole
6.54	7.17	2.00	1.65	0.22

CEX series multi-pin– 12 Shell

Example: **CEX-133B12-310PN-01-BS**

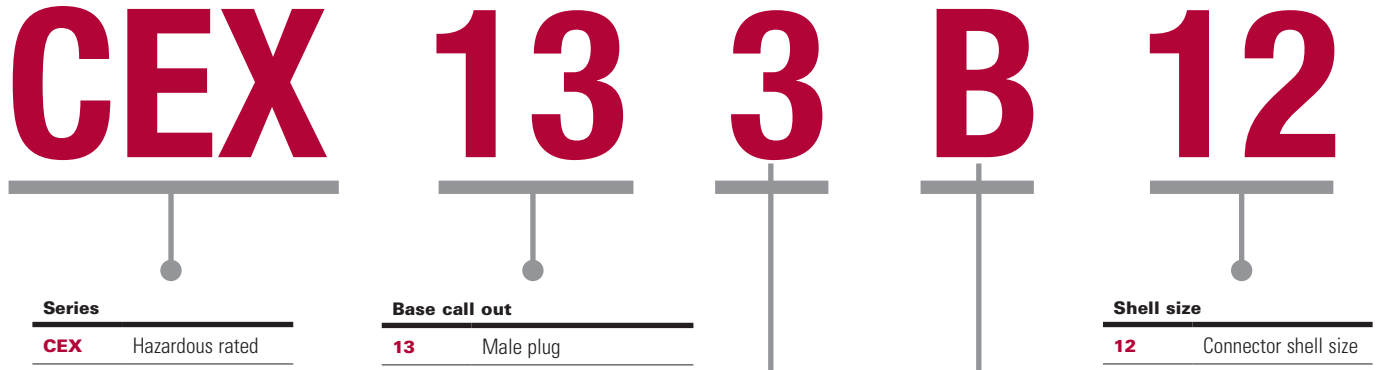

Cable hardware

1*	Panel mount
2*	Mechanical clamp
3	Eex d gland
4*	Basketweave cable grip

* Includes potting compound

Panel mount
 leave blank if cable hardware #1 "Panel Mount" is selected

Cable gland
 refer to the cable gland table below if cable hardware #3 "Eex d Gland" is selected

Grommet
 refer to the grommet table below if cable hardware #2 or #4 option is selected

EX cable gland

	Unarmored sheath		Armored	
	Inner sheath	Outer sheath	Inner sheath	Outer sheath
A1	4.0 - 8.5	4.5 - 8.0	7.0 - 12.0	0.9
A2	7.0 - 12.0	7.0 - 12.0	10.5 - 16.0	1.3
A	10.5 - 16.0	10.5 - 15.5	13.5 - 21.0	1.3
B	13.5 - 20.5	13.5 - 20.5	18.0 - 27.5	1.6
C	18.0 - 27.5	18.0 - 26.0	23.0 - 34.0	1.6

Grommet

	Cable diameter	
	in.	mm.
03	.125 - .188	1.6 - 3.2
04	.125 - .250	3.2 - 6.4
06	.250 - .375	6.4 - 9.5
08	.375 - .500	9.5 - 12.7
10	.500 - .625	12.7 - 15.9
12	.625 - .750	15.9 - 19.1
14	.750 - .875	19.1 - 22.2

Contact amperage ratings

Contact size (AWG / MCM)	Non-circuit breaking current rating @ 55°C*
16 AWG	18
12 AWG	30
10 AWG	40

* Cable current rating must meet or exceed the ratings of the contacts to utilize connector at fully rated current.

NEC Service voltage ratings

Service voltage	Non-circuit breaking	
	DC volts RMS	Circuit breaking AC volts RMS
A	250	240
D	600	600
E	600	600
B	600	600

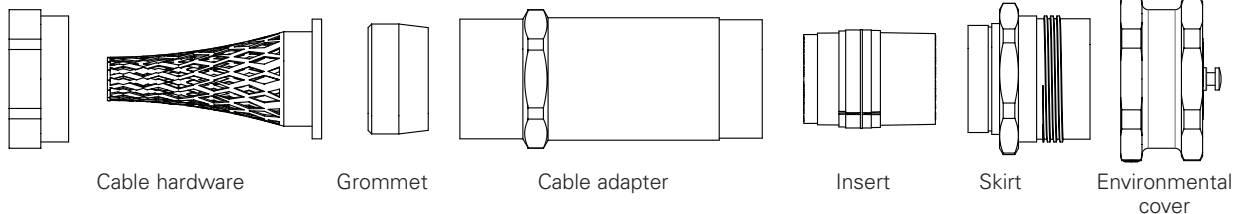

310 P N 01 BS

Contact gender

P	Male pin
S	Female socket

Termination method

N	Crimp
----------	-------

Alternate key position

BLANK	0 degrees
--------------	-----------

See appendix p. 67 for locking options

Series

BLANK	Unarmored
-BS	Armored & sheathed

Plating

BLANK	Silver (crimp or solder) Nickel (pressure)
K	Gold (crimp only)

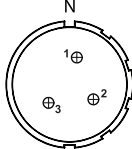
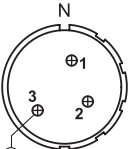
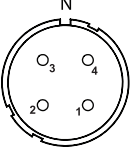
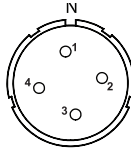
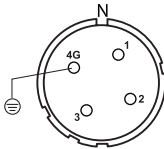
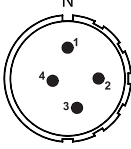
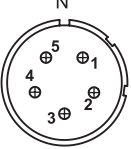
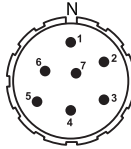
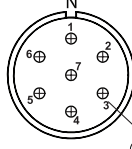
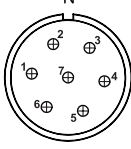
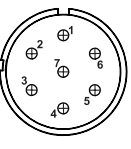
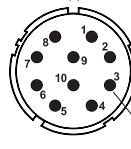
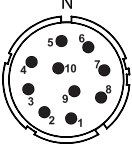
 <table border="1" data-bbox="276 955 462 1102"> <tr><td>327</td></tr> <tr><td># Contacts 3</td></tr> <tr><td>AWG 12</td></tr> <tr><td>Service voltage rating D</td></tr> </table>	327	# Contacts 3	AWG 12	Service voltage rating D	 <table border="1" data-bbox="641 955 828 1102"> <tr><td>330*</td></tr> <tr><td># Contacts 3</td></tr> <tr><td>AWG 12</td></tr> <tr><td>Service voltage rating D</td></tr> </table>	330*	# Contacts 3	AWG 12	Service voltage rating D	 <table border="1" data-bbox="1006 955 1193 1102"> <tr><td>314</td></tr> <tr><td># Contacts 4</td></tr> <tr><td>AWG 10</td></tr> <tr><td>Service voltage rating D</td></tr> </table>	314	# Contacts 4	AWG 10	Service voltage rating D	 <table border="1" data-bbox="1364 955 1550 1102"> <tr><td>316</td></tr> <tr><td># Contacts 4</td></tr> <tr><td>AWG 10</td></tr> <tr><td>Service voltage rating D</td></tr> </table>	316	# Contacts 4	AWG 10	Service voltage rating D
327																			
# Contacts 3																			
AWG 12																			
Service voltage rating D																			
330*																			
# Contacts 3																			
AWG 12																			
Service voltage rating D																			
314																			
# Contacts 4																			
AWG 10																			
Service voltage rating D																			
316																			
# Contacts 4																			
AWG 10																			
Service voltage rating D																			
 <table border="1" data-bbox="276 1176 462 1323"> <tr><td>322</td></tr> <tr><td># Contacts 4</td></tr> <tr><td>AWG 10</td></tr> <tr><td>Service voltage rating D</td></tr> </table>	322	# Contacts 4	AWG 10	Service voltage rating D	 <table border="1" data-bbox="641 1176 828 1323"> <tr><td>333</td></tr> <tr><td># Contacts 4</td></tr> <tr><td>AWG 16</td></tr> <tr><td>Service voltage rating D</td></tr> </table>	333	# Contacts 4	AWG 16	Service voltage rating D	 <table border="1" data-bbox="1006 1176 1193 1323"> <tr><td>324</td></tr> <tr><td># Contacts 5</td></tr> <tr><td>AWG 12</td></tr> <tr><td>Service voltage rating D</td></tr> </table>	324	# Contacts 5	AWG 12	Service voltage rating D	 <table border="1" data-bbox="1364 1176 1550 1323"> <tr><td>348</td></tr> <tr><td># Contacts 7</td></tr> <tr><td>AWG 16</td></tr> <tr><td>Service voltage rating A</td></tr> </table>	348	# Contacts 7	AWG 16	Service voltage rating A
322																			
# Contacts 4																			
AWG 10																			
Service voltage rating D																			
333																			
# Contacts 4																			
AWG 16																			
Service voltage rating D																			
324																			
# Contacts 5																			
AWG 12																			
Service voltage rating D																			
348																			
# Contacts 7																			
AWG 16																			
Service voltage rating A																			
 <table border="1" data-bbox="276 1396 462 1543"> <tr><td>310</td></tr> <tr><td># Contacts 7</td></tr> <tr><td>AWG 12</td></tr> <tr><td>Service voltage rating A</td></tr> </table>	310	# Contacts 7	AWG 12	Service voltage rating A	 <table border="1" data-bbox="641 1396 828 1543"> <tr><td>354</td></tr> <tr><td># Contacts 7</td></tr> <tr><td>AWG 12</td></tr> <tr><td>Service voltage rating A</td></tr> </table>	354	# Contacts 7	AWG 12	Service voltage rating A	 <table border="1" data-bbox="1006 1396 1193 1543"> <tr><td>354D</td></tr> <tr><td># Contacts 7</td></tr> <tr><td>AWG 12</td></tr> <tr><td>Service voltage rating A</td></tr> </table>	354D	# Contacts 7	AWG 12	Service voltage rating A	 <table border="1" data-bbox="1364 1396 1550 1543"> <tr><td>334</td></tr> <tr><td># Contacts 10</td></tr> <tr><td>AWG 16</td></tr> <tr><td>Service voltage rating A</td></tr> </table>	334	# Contacts 10	AWG 16	Service voltage rating A
310																			
# Contacts 7																			
AWG 12																			
Service voltage rating A																			
354																			
# Contacts 7																			
AWG 12																			
Service voltage rating A																			
354D																			
# Contacts 7																			
AWG 12																			
Service voltage rating A																			
334																			
# Contacts 10																			
AWG 16																			
Service voltage rating A																			
 <table border="1" data-bbox="276 1606 462 1753"> <tr><td>355</td></tr> <tr><td># Contacts 10</td></tr> <tr><td>AWG 16</td></tr> <tr><td>Service voltage rating A</td></tr> </table>	355	# Contacts 10	AWG 16	Service voltage rating A	<p>*Made to order item. Consult factory for availability and lead time.</p>														
355																			
# Contacts 10																			
AWG 16																			
Service voltage rating A																			

Contact Symbol	○	●	⊕	○	⊙	●	⊕	⊗	⊕	⊗	○	⊗
AWG	18	16	12	10	8	4	1/0	4/0	313 MCM	444 MCM	535 MCM	777 MCM

16 Shell

Applications:

Hazardous location control and instrumentation

Certifications:

- CE marked
- AEx listed for US Ex Zone 1 Applications (ETL)
- Listed for Canada Ex Zone 1 Applications (ETL)
- ATEX Group II Category 2 certified (ETL)
- IECEx Zone 1 Certified (ETL)
- EAc Certified (Russia)
- INMETRO Certified (Brazil)

Ambient temperature rating:

- Certified for use at: -60°C to +55°C

Environmental:

- IP66, IP68
- NEMA 4X, 6P

Construction:

- Contacts - silver plated copper, crimp or solder style; nickel plated brass, pressure style; optional gold plated (crimp only)
- Shells - high tensile strength aluminum; hard anodic coating per MIL-A-8625, Type III, black color
- Rigid insulators - thermoplastic
- Resilient inserts - silicone rubber

Features & benefits:

- Reversible inserts are compatible with all panel mount, in-line, male and female shells
- Exclusive visual mating alignment
- Easily accessible wire terminals
- Ample wiring space within shells
- Reversible 8-point diamond cord grip relieves strain on conductors (patent pending)
- Suited for use with Type P cable
- EX cable glands available through Crouse-Hinds
- Hexagon shell design with easy wrenching surfaces ensures adequate torquing
- Impact-resistant



Cable mounted plug with mechanical clamp

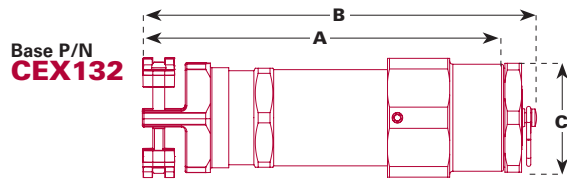

Base P/N
CEX132

A	B	C
Length w/o cap	Length w/ cap	Width
9.14	10.00	2.25

Cable mounted plug with EX cable gland

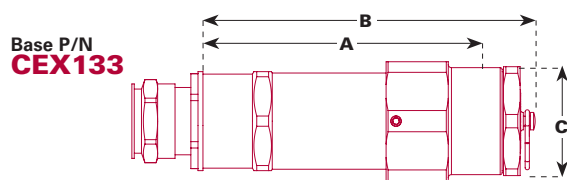

Base P/N
CEX133

A	B	C
Length w/o cap	Length w/ cap	Width
7.71	8.57	2.25

Cable mounted plug with basketweave

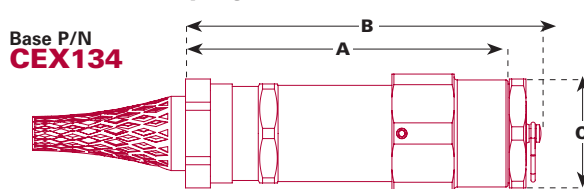

Base P/N
CEX134

A	B	C
Length w/o cap	Length w/ cap	Width
8.18	9.04	2.25

Cable mounted receptacle with mechanical clamp

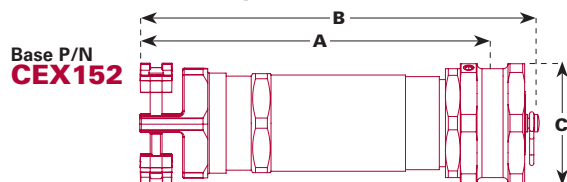

Base P/N
CEX152

A	B	C
Length w/o cap	Length w/ cap	Width
9.50	10.13	2.50



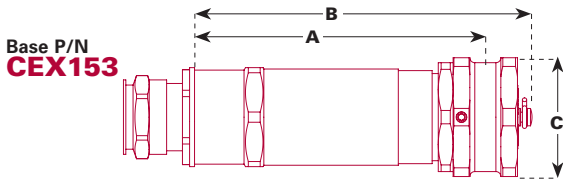

Cable mounted receptacle with EX gland nut

A	B	C
Length w/o cap	Length w/ cap	Width
8.08	8.71	2.50

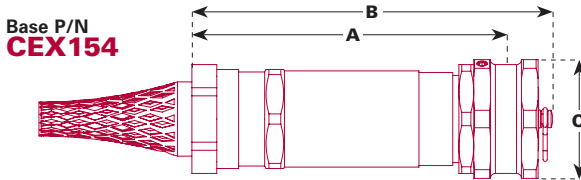

Cable mounted receptacle with basketweave

A	B	C
Length w/o cap	Length w/ cap	Width
8.54	9.17	2.50

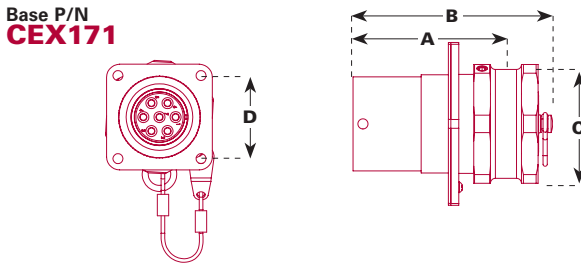

Panel mounted receptacle

A	B	C	D	Diameter
Length w/o cap	Length w/ cap	Width	Ctr. - ctr. mount hole	Mount hole
4.89	5.52	2.50	2.05	0.22

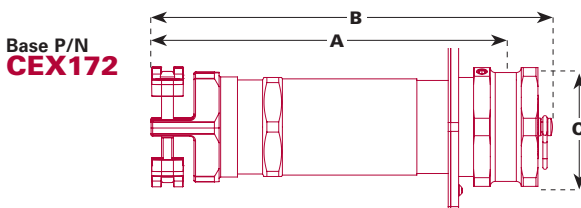

Cable mounted square flange receptacle with mechanical clamp

A	B	C	D	Diameter
Length w/o cap	Length w/ cap	Width	Ctr. - ctr. mount hole	Mount hole
9.50	10.13	2.50	2.05	0.22

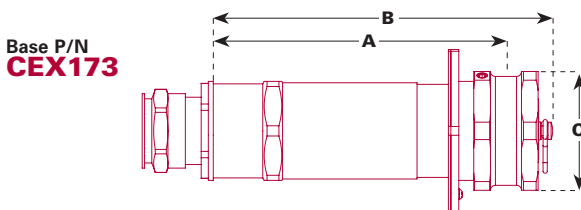

Cable mounted square flange receptacle with EX cable gland

A	B	C	D	Diameter
Length w/o cap	Length w/ cap	Width	Ctr. - ctr. mount hole	Mount hole
8.08	8.71	2.50	2.05	0.22

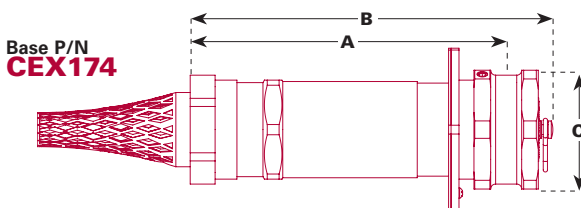

Cable mounted square flange receptacle with basketweave

A	B	C	D	Diameter
Length w/o cap	Length w/ cap	Width	Ctr. - ctr. mount hole	Mount hole
8.54	9.17	2.50	2.05	0.22

CEX series multi-pin– 16 Shell

Example: **CEX133B16321PN-01-BS**

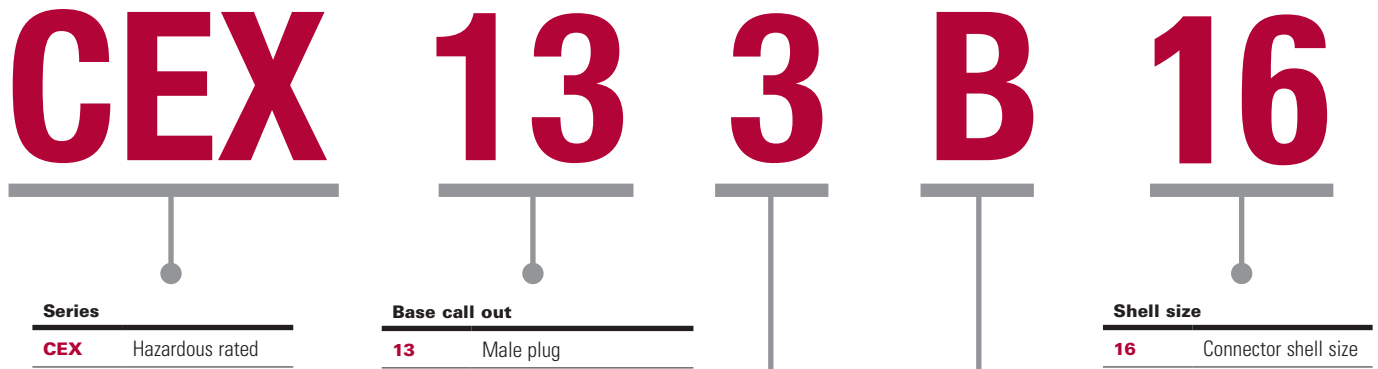

Series	
CEX	Hazardous rated

Base call out	
13	Male plug
15	Female in-line
17	Female panel mount

Shell size	
16	Connector shell size

Cable hardware	
1*	Panel mount
2*	Mechanical clamp
3	Eex d gland
4*	Basketweave cable grip

* Includes potting compound

Panel mount
leave blank if cable hardware #1 "Panel Mount" is selected

Cable gland
refer to the cable gland table below if cable hardware #3 "Eex d Gland" is selected

Grommet
refer to the grommet table below if cable hardware #2 or #4 option is selected

Grommet		
	Cable diameter	
	in.	mm.
08	.375 - .500	9.5 - 12.7
10	.500 - .625	12.7 - 15.9
12	.625 - .750	15.9 - 19.1
14	.750 - .875	19.1 - 22.2
16	.875 - 1.000	22.2 - 25.4
18	1.000 - 1.125	25.4 - 28.6
20	1.125 - 1.250	28.6 - 31.8

EX cable gland				
	Unarmored sheath	Armored		
		Inner sheath	Outer sheath	Armor (max)
A	10.0 - 16.0	10.0 - 15.5	13.5 - 21.0	1.3
B	13.5 - 20.5	13.5 - 20.5	18.0 - 27.5	1.6
C	18.0 - 27.5	18.0 - 26.0	23.0 - 34.0	1.6
C2	23.0 - 34.0	23.0 - 34.0	29.0 - 41.0	2.0
D	29.0 - 41.0	29.0 - 41.0	35.0 - 48.0	2.5

Contact amperage ratings

Contact size (AWG / MCM)	Non-circuit breaking current rating @ 55°C*
16 AWG	18
12 AWG	30
10 AWG	40
8 AWG	55
4 AWG	73

* Cable current rating must meet or exceed the ratings of the contacts to utilize connector at fully rated current.

NEC Service voltage ratings

Service voltage	Non-circuit breaking	Circuit breaking
	DC volts RMS	AC volts RMS
A	250	240
D	600	600
E	600	600
B	600	600

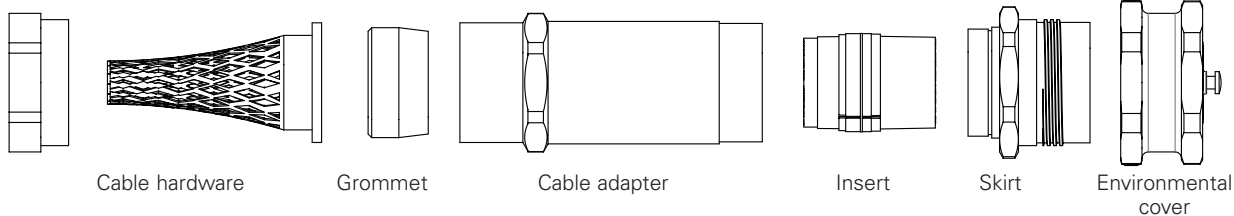

321 P N 01 BS

Contact gender

P	Male pin
S	Female socket

Termination method

N	Crimp
R	Pressure

Alternate key position

BLANK	0 degrees
--------------	-----------

See appendix p. 68 for clocking options

Series

BLANK	Unarmored
-BS	Armored & sheathed

Plating

BLANK	Silver (crimp or solder) Nickel (pressure)
K	Gold (crimp only)

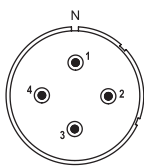

328

# Contacts	4
AWG	8
Service voltage rating	D

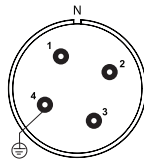

38

# Contacts	4
AWG	4
Service voltage rating	D

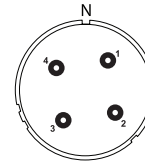

322

# Contacts	4
AWG	4
Service voltage rating	D

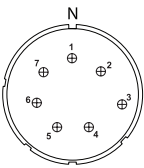

378

# Contacts	7
AWG	12
Service voltage rating	D

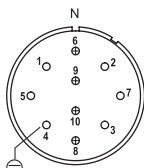

376

# Contacts	6	4
AWG	12	10
Service voltage rating	D	

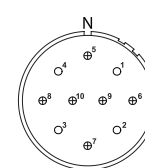

381

# Contacts	6	4
AWG	12	10
Service voltage rating	D	

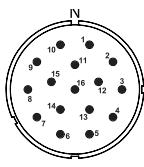

325

# Contacts	16
AWG	16
Service voltage rating	D

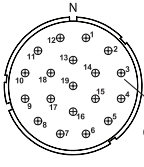

312

# Contacts	19
AWG	12
Service voltage rating	A

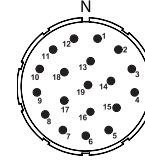

355

# Contacts	19
AWG	16
Service voltage rating	A

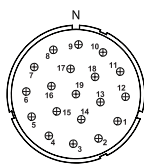

377

# Contacts	19
AWG	12
Service voltage rating	A

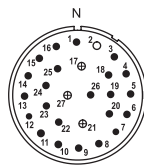

335

# Contacts	24	3
AWG	16	12
Service voltage rating	A	

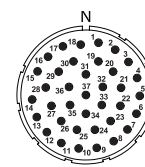

321

# Contacts	37
AWG	16
Service voltage rating	A

***Made to order item. Consult factory for availability and lead time.**

Contact Symbol	○	●	⊕	○	⦿	●	⊕	⊖	⊖	⊖	⊖	
AWG	18	16	12	10	8	4	1/0	4/0	313 MCM	444 MCM	535 MCM	777 MCM

CEX series multi-pin 20 Shell

Applications:

Hazardous location control and instrumentation

Certifications:

- CE marked
- AEx listed for US Ex Zone 1 Applications (ETL)
- Listed for Canada Ex Zone 1 Applications (ETL)
- ATEX Group II Category 2 certified (ETL)
- IECEx Zone 1 Certified (ETL)
- EAc Certified (Russia)
- INMETRO Certified (Brazil)

Ambient temperature rating:

- Certified for use at: -60°C to +55°C

Environmental:

- IP66, IP68
- NEMA 4X, 6P

Construction:

- Contacts - silver plated copper, crimp or solder style; nickel plated brass, pressure style; optional gold plated (crimp only)
- Shells - high tensile strength aluminum; hard anodic coating per MIL-A-8625, Type III, black color
- Rigid insulators - thermoplastic
- Resilient inserts - silicone rubber

Features & benefits:

- Reversible inserts are compatible with all panel mount, in-line, male and female shells
- Exclusive visual mating alignment
- Easily accessible wire terminals
- Ample wiring space within shells
- Reversible 8-point diamond cord grip relieves strain on conductors (patent pending)
- Suited for use with Type P cable
- EX cable glands available through Crouse-Hinds
- Hexagon shell design with easy wrenching surfaces ensures adequate torquing
- Impact-resistant



Cable mounted plug with mechanical clamp

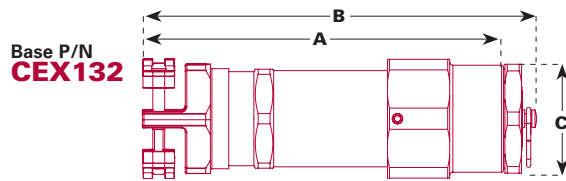

Base P/N
CEX132

A	B	C
Length w/o cap	Length w/ cap	Width
9.14	10.00	2.75

Cable mounted plug with EX cable gland

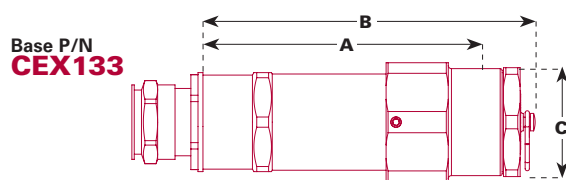

Base P/N
CEX133

A	B	C
Length w/o cap	Length w/ cap	Width
7.71	8.57	2.75

Cable mounted plug with basketweave

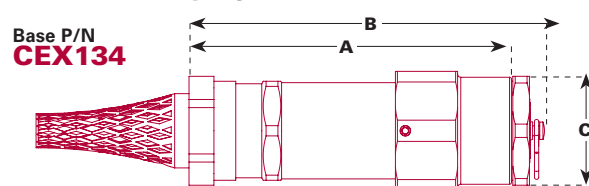

Base P/N
CEX134

A	B	C
Length w/o cap	Length w/ cap	Width
8.18	9.04	2.75

Cable mounted receptacle with EX cable gland

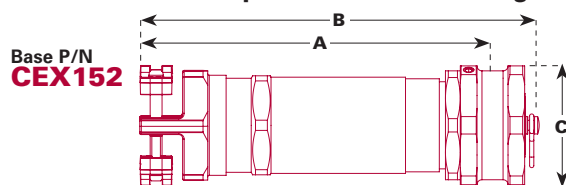

Base P/N
CEX152

A	B	C
Length w/o cap	Length w/ cap	Width
9.50	10.13	3.00



Base P/N
CEX154

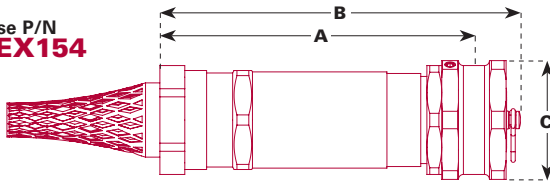

Cable mounted receptacle with basketweave

A	B	C
Length w/o cap	Length w/ cap	Width
8.54	9.17	3.00

Base P/N
CEX153

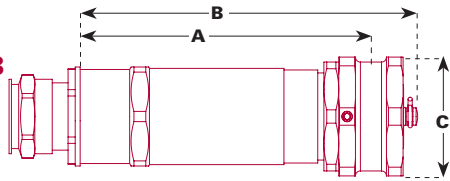

Cable mounted receptacle with EX cable gland

A	B	C
Length w/o cap	Length w/ cap	Width
8.08	8.71	3.00

Base P/N
CEX171

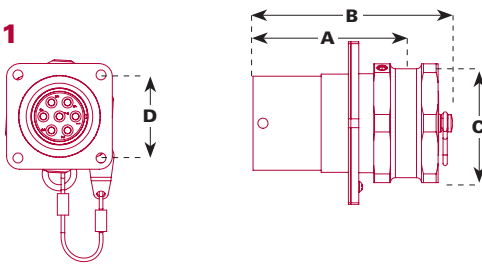

Panel mounted receptacle

A	B	C	D	Diameter
Length w/o cap	Length w/ cap	Width	Ctr. - ctr. mount hole	Mount hole
4.89	5.52	3.00	2.44	0.22

Base P/N
CEX172

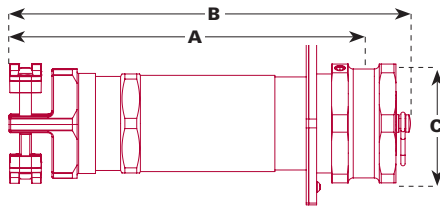

Cable mounted square flange receptacle with mechanical clamp

A	B	C	D	Diameter
Length w/o cap	Length w/ cap	Width	Ctr. - ctr. mount hole	Mount hole
9.50	10.13	3.00	2.44	0.22

Base P/N
CEX173

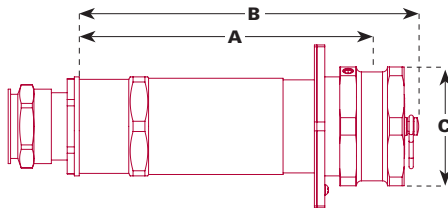

Cable mounted square flange receptacle with EX cable gland

A	B	C	D	Diameter
Length w/o cap	Length w/ cap	Width	Ctr. - ctr. mount hole	Mount hole
8.08	8.71	3.00	2.44	0.22

Base P/N
CEX174

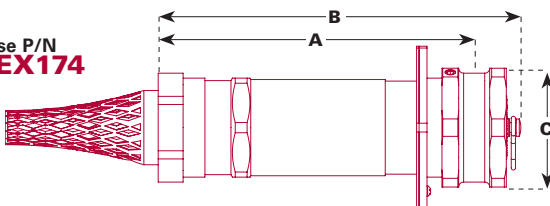

Cable mounted square flange receptacle with basketweave

A	B	C	D	Diameter
Length w/o cap	Length w/ cap	Width	Ctr. - ctr. mount hole	Mount hole
8.54	9.17	3.00	2.44	0.22

CEX series multi-pin– 20 Shell

Example: **CEX-133B20-376PN-01-BS**

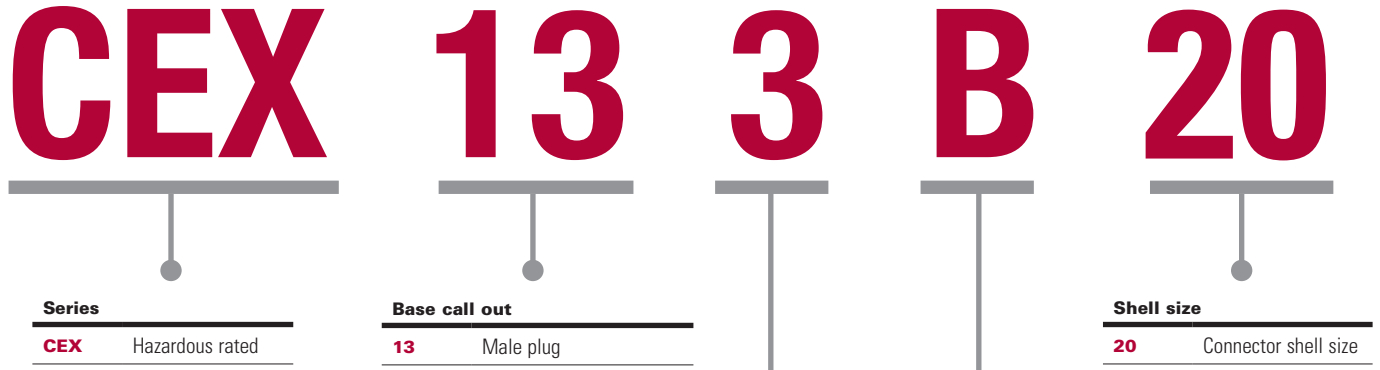

Series

CEX	Hazardous rated
------------	-----------------

Base call out

13	Male plug
15	Female in-line
17	Female panel mount

Shell size

20	Connector shell size
-----------	----------------------

Cable hardware

1*	Panel mount
2*	Mechanical clamp
3	Eex d gland
4*	Basketweave cable grip

* Includes potting compound

Panel mount
leave blank if cable hardware #1 "Panel Mount" is selected

Cable gland
refer to the cable gland table below if cable hardware #3 "Eex d Gland" is selected

Grommet
refer to the grommet table below if cable hardware #2 or #4 option is selected

Grommet

	Cable diameter	
	in.	mm.
10	0.500 - 0.625	12.7 - 15.9
12	0.625 - 0.750	15.9 - 19.1
14	0.750 - 0.875	19.1 - 22.2
16	0.875 - 1.000	22.2 - 25.4
18	1.000 - 1.125	25.4 - 28.6
20	1.125 - 1.250	28.6 - 31.8
22	1.250 - 1.375	31.8 - 34.9
24	1.375 - 1.500	34.9 - 38.1
26	1.500 - 1.625	38.1 - 41.3

EX cable gland

	Armored			
	Unarmored sheath	Inner sheath	Outer sheath	Armor (max)
A	10.0 - 16.0	10.0 - 15.5	13.5 - 21.0	1.3
B	13.5 - 20.5	13.5 - 20.5	18.0 - 27.5	1.6
C	18.0 - 27.5	18.0 - 27.5	23.0 - 34.0	1.6
C2	23.0 - 34.0	23.0 - 34.0	29.0 - 41.0	2.0
D	29.0 - 41.0	29.0 - 41.0	35.0 - 48.0	2.5
D2	35.0 - 45.0	35.0 - 48.0	42.0 - 56.0	2.5
E	42.0 - 56.0	42.0 - 53.0	50.0 - 65.0	2.5

NEC service voltage ratings

Service voltage	Non-circuit breaking DC volts RMS	Circuit breaking AC volts RMS
A	250	240
D	600	600
E	600	600
B	600	600

Contact amperage ratings

Contact size (AWG / MCM)	Non-circuit breaking current rating @ 55°C*
16 AWG	18
12 AWG	30
10 AWG	40
8 AWG	55
4 AWG	73
1/0 AWG	130

* Cable current rating must meet or exceed the ratings of the contacts to utilize connector at fully rated current.

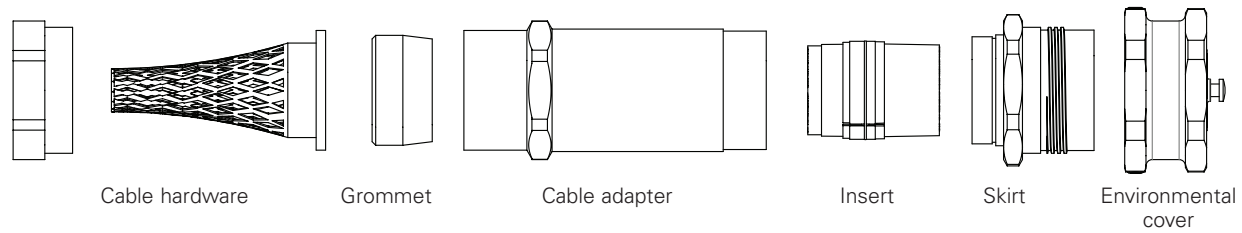

376

P

N

01

BS

Contact gender

P	Male pin
S	Female socket

Termination method

N	Crimp
R	Pressure

Plating

BLANK	Silver (crimp or solder) Nickel (pressure)
K	Gold (crimp only)

Alternate key position

BLANK	0 degrees
--------------	-----------

See appendix p. 69 for locking options

Series

BLANK	Unarmored
-BS	Armored & sheathed

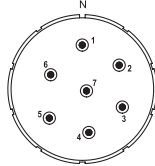

359*

# Contacts	7
AWG	8
Service voltage rating	E

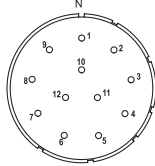

375

# Contacts	12
AWG	10
Service voltage rating	D

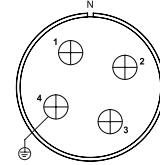

40

# Contacts	4
AWG	1/0
Service voltage rating	D

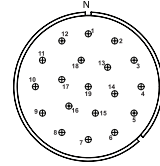

376

# Contacts	19
AWG	12
Service voltage rating	D

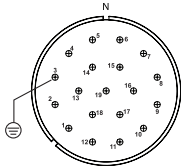

388

# Contacts	19
AWG	12
Service voltage rating	D

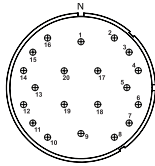

332

# Contacts	20
AWG	12
Service voltage rating	B Center A Outer

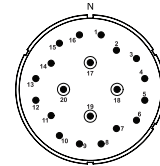

334

# Contacts	16 4
AWG	16 8
Service voltage rating	D

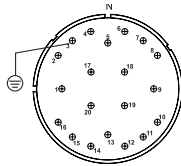

387

# Contacts	20
AWG	12
Service voltage rating	B Center A Outer

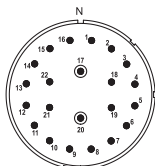

331*

# Contacts	20 2
AWG	16 8
Service voltage rating	D (16 AWG) E (8 AWG)

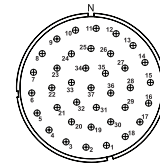

386

# Contacts	37
AWG	12
Service voltage rating	A

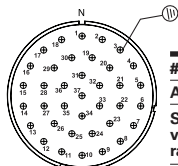

350

# Contacts	37
AWG	12
Service voltage rating	A

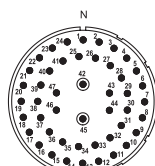

354*

# Contacts	45 2
AWG	16 8
Service voltage rating	D (8 AWG) A (16 AWG)

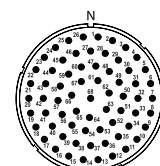

313

# Contacts	68
AWG	16
Service voltage rating	A

*Made to order item. Consult factory for availability and lead time.

Contact Symbol	○	●	⊕	○	⦿	●	⊕	⊖	⊕	⊖	⊕	⊖
AWG	18	16	12	10	8	4	1/0	4/0	313 MCM	444 MCM	535 MCM	777 MCM

CEX series multi-pin 24 Shell

Applications:

Hazardous location control and instrumentation

Certifications:

- CE marked
- AEx listed for US Ex Zone 1 Applications (ETL)
- Listed for Canada Ex Zone 1 Applications (ETL)
- ATEX Group II Category 2 certified (ETL)
- IECEx Zone 1 Certified (ETL)
- EAc Certified (Russia)
- INMETRO Certified (Brazil)

Ambient temperature rating:

- Certified for use at: -60°C to +55°C

Environmental:

- IP66, IP68
- NEMA 4X, 6P

Construction:

- Contacts - silver plated copper, crimp or solder style; nickel plated brass, pressure style; optional gold plated (crimp only)
- Shells - high tensile strength aluminum; hard anodic coating per MIL-A-8625, Type III, black color
- Rigid insulators - thermoplastic
- Resilient inserts - silicone rubber

Features & benefits:

- Reversible inserts are compatible with all panel mount, in-line, male and female shells
- Exclusive visual mating alignment
- Easily accessible wire terminals
- Ample wiring space within shells
- Reversible 8-point diamond cord grip relieves strain on conductors (patent pending)
- Suited for use with Type P cable
- EX cable glands available through Crouse-Hinds
- Hexagon shell design with easy wrenching surfaces ensures adequate torquing
- Impact-resistant



Cable mounted plug with mechanical clamp

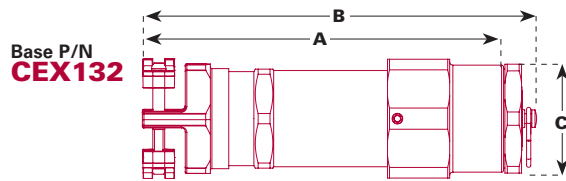

Base P/N
CEX132

A	B	C
Length w/o cap	Length w/ cap	Width
9.14	10.00	3.25

Cable mounted plug with EX cable gland

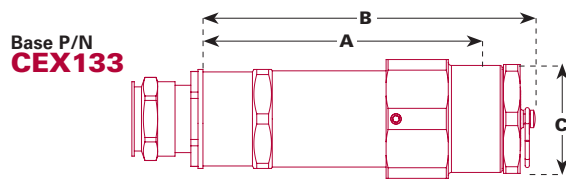

Base P/N
CEX133

A	B	C
Length w/o cap	Length w/ cap	Width
7.71	8.57	3.25

Cable mounted plug with basketweave

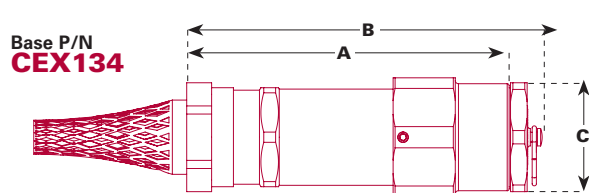

Base P/N
CEX134

A	B	C
Length w/o cap	Length w/ cap	Width
8.18	9.04	3.25

Cable mounted receptacle with mechanical clamp

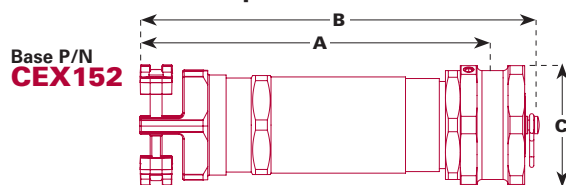

Base P/N
CEX152

A	B	C
Length w/o cap	Length w/ cap	Width
9.50	10.13	3.50



Base P/N
CEX154

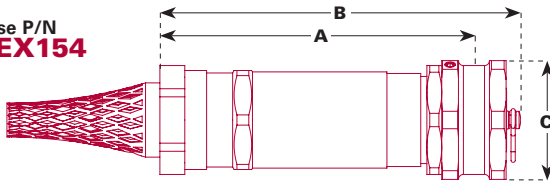

Cable mounted receptacle with basketweave

A	B	C
Length w/o cap	Length w/ cap	Width
8.54	9.17	3.00

Base P/N
CEX153

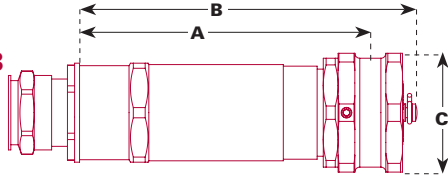

Cable mounted receptacle with EX cable gland

A	B	C
Length w/o cap	Length w/ cap	Width
8.08	8.71	3.50

Base P/N
CEX171

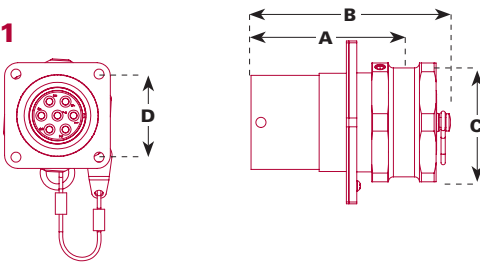

Panel mounted receptacle

A	B	C	D	Diameter
Length w/o cap	Length w/ cap	Width	Ctr. - ctr. mount hole	Mount hole
4.89	5.52	3.50	2.84	0.22

Base P/N
CEX172

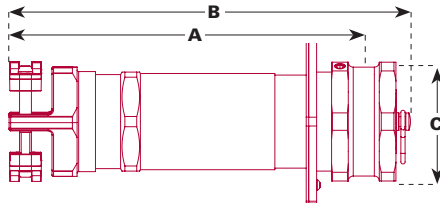

Cable mounted square flange receptacle with mechanical clamp

A	B	C	D	Diameter
Length w/o cap	Length w/ cap	Width	Ctr. - ctr. mount hole	Mount hole
9.50	10.13	3.50	2.84	0.22

Base P/N
CEX173

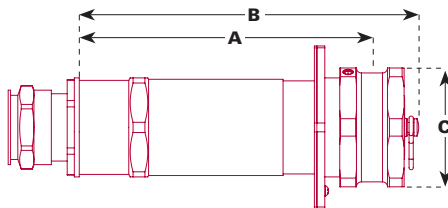

Cable mounted square flange receptacle with EX cable gland

A	B	C	D	Diameter
Length w/o cap	Length w/ cap	Width	Ctr. - ctr. mount hole	Mount hole
8.08	8.71	3.50	2.84	0.22

Base P/N
CEX174

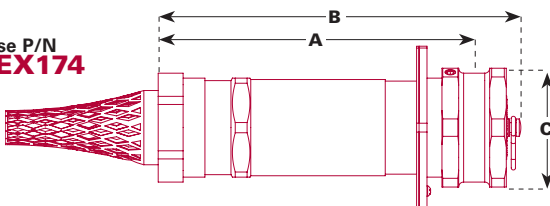

Cable mounted square flange receptacle with basketweave

A	B	C	D	Diameter
Length w/o cap	Length w/ cap	Width	Ctr. - ctr. mount hole	Mount hole
8.54	9.17	3.50	2.84	0.22

CEX series multi-pin– 24 Shell

Example: **CEX133D24371PN-01-BS**

CEX

Series

CEX Hazardous rated

13

Base call out

13 Male plug
15 Female in-line
17 Female panel mount

3

Cable hardware

1* Panel mount
2* Mechanical clamp
3 Eex d gland
4* Basketweave cable grip
 * Includes potting compound

D

24

Shell size

24 Connector shell size
C24 C length shell size

Panel mount
 leave blank if cable hardware #1 "Panel Mount" is selected

Cable gland
 refer to the cable gland table below if cable hardware #3 "Eex d Gland" is selected

Grommet
 refer to the grommet table below if cable hardware #2 or #4 option is selected

EX cable gland				
	Unarmored min-max	Armored		
		Inner sheath	Outer sheath	Armor (max)
C2	23.0 - 34.0	23.0 - 34.0	29.0 - 41.0	2.0
D	29.0 - 41.0	29.0 - 41.0	35.0 - 48.0	2.5
D2	35.0 - 45.0	35.0 - 48.0	42.0 - 56.0	2.5
E	42.0 - 56.0	42.0 - 53.0	50.0 - 65.0	2.5
F	50.0 - 65.0	50.0 - 62.5	58.0 - 74.0	2.5

Grommet		
	Cable diameter	
	in.	mm.
16	0.875 - 1.000	22.2 - 25.4
18	1.000 - 1.125	25.4 - 28.6
20	1.125 - 1.250	28.6 - 31.8
22	1.250 - 1.375	31.8 - 34.9
24	1.375 - 1.500	34.9 - 38.1
26	1.500 - 1.625	38.1 - 41.2
28	1.625 - 1.750	41.2 - 44.4
30	1.750 - 1.875	44.4 - 47.6

Contact amperage ratings

Contact size (AWG / MCM)	Non-circuit breaking current rating @ 55°C*
16 AWG	18
12 AWG	30
1/0 AWG	130
4/0 AWG	198

* Cable current rating must meet or exceed the ratings of the contacts to utilize connector at fully rated current.

NEC service voltage ratings

Service voltage	Non-circuit breaking	Circuit breaking
	DC volts RMS	AC volts RMS
A	250	240
D	600	600
E	600	600
B	600	600

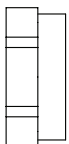

Cable hardware

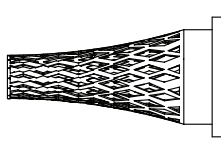

Grommet

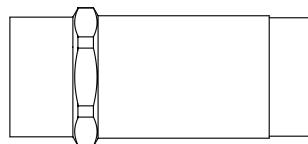

Cable adapter

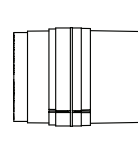

Insert

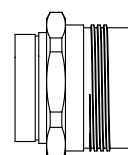

Skirt

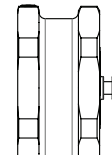

Environmental cover

371 P N 01 BS

Contact gender

P	Male pin
S	Female socket

Termination method

N	Crimp
R	Pressure

Plating

BLANK	Silver (crimp or solder) Nickel (pressure)
K	Gold (crimp only)

Alternate key position

BLANK	0 degrees
--------------	-----------

See appendix p. 70 for locking options

Series

BLANK	Unarmored
-BS	Armored & sheathed

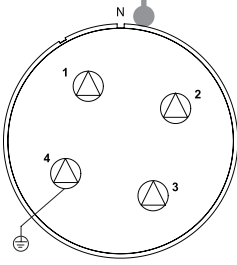

26

# Contacts	4
AWG	4/0
Service voltage rating	D

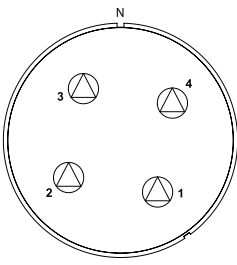

38

# Contacts	4
AWG	4/0
Service voltage rating	D

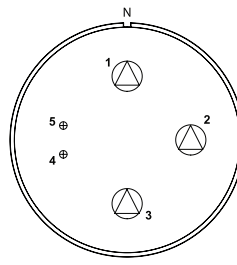

48*

# Contacts	2 3
AWG	12 4/0
Service voltage rating	A D

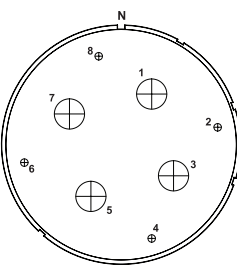

53

# Contacts	4 4
AWG	12 1/0
Service voltage rating	A B

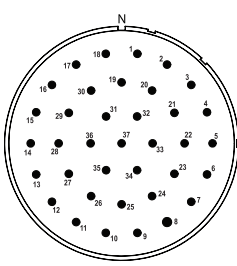

371

# Contacts	37
AWG	16
Service voltage rating	D

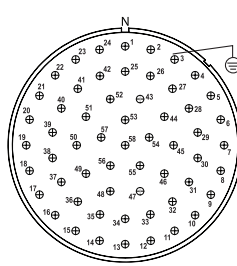

352

# Contacts	58
AWG	12
Service voltage rating	A

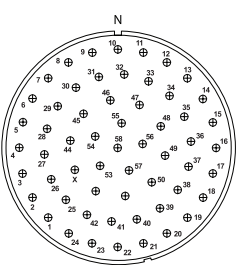

384

# Contacts	58
AWG	12
Service voltage rating	A

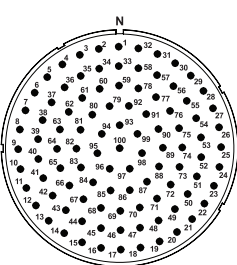

313

# Contacts	100
AWG	16
Service voltage rating	A

***Made to order item. Consult factory for availability and lead time.**

Contact Symbol	○	●	⊕	○	⦿	●	⊕	⊖	⊖	⊖	⊖
AWG	18	16	12	10	8	4	1/0	4/0	313 MCM	444 MCM	535 MCM 777 MCM

CEX series multi-pin 28 Shell

Applications:

Hazardous location control and instrumentation

Certifications:

- CE marked
- AEx listed for US Ex Zone 1 Applications (ETL)
- Listed for Canada Ex Zone 1 Applications (ETL)
- ATEX Group II Category 2 certified (ETL)
- IECEx Zone 1 Certified (ETL)
- EAc Certified (Russia)
- INMETRO Certified (Brazil)

Ambient temperature rating:

- Certified for use at: -60°C to +55°C

Environmental:

- IP66, IP68
- NEMA 4X, 6P

Construction:

- Contacts - silver plated copper, crimp or solder style; nickel plated brass, pressure style; optional gold plated (crimp only)
- Shells - high tensile strength aluminum; hard anodic coating per MIL-A-8625, Type III, black color
- Rigid insulators - thermoplastic
- Resilient inserts - silicone rubber

Features & benefits:

- Reversible inserts are compatible with all panel mount, in-line, male and female shells
- Exclusive visual mating alignment
- Easily accessible wire terminals
- Ample wiring space within shells
- Reversible 8-point diamond cord grip relieves strain on conductors (patent pending)
- Suited for use with Type P cable
- EX cable glands available through Crouse-Hinds
- Hexagon shell design with easy wrenching surfaces ensures adequate torquing
- Impact-resistant



Cable mounted plug with mechanical clamp

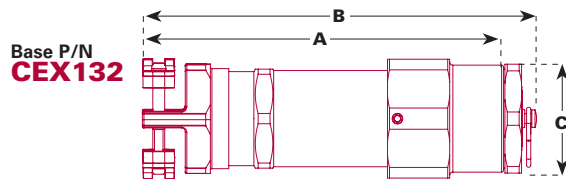

Base P/N
CEX132

A	B	C
Length w/o cap	Length w/ cap	Width
9.14	10.00	3.25

Cable mounted plug with EX cable gland

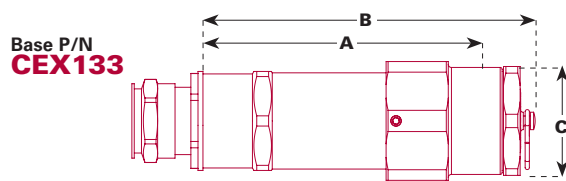

Base P/N
CEX133

A	B	C
Length w/o cap	Length w/ cap	Width
7.71	8.57	3.25

Cable mounted plug with basketweave

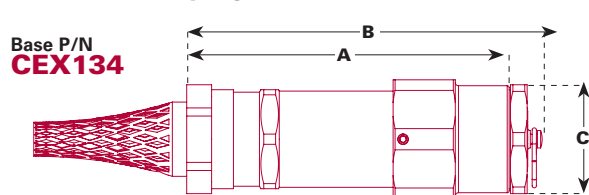

Base P/N
CEX134

A	B	C
Length w/o cap	Length w/ cap	Width
8.18	9.04	3.25

Cable mounted receptacle with mechanical clamp

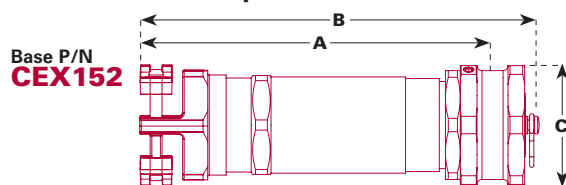

Base P/N
CEX152

A	B	C
Length w/o cap	Length w/ cap	Width
9.50	10.13	3.50



Base P/N
CEX154

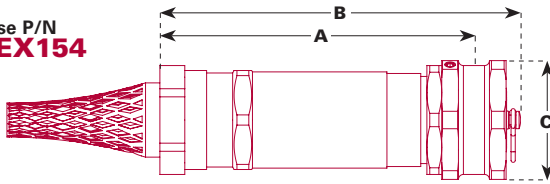

Cable mounted receptacle with basketweave

A	B	C
Length w/o cap	Length w/ cap	Width
8.54	9.17	3.50

Base P/N
CEX153

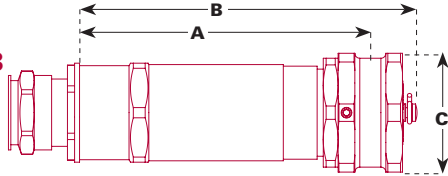

Cable mounted receptacle with EX cable gland

A	B	C
Length w/o cap	Length w/ cap	Width
8.08	8.71	3.50

Base P/N
CEX171

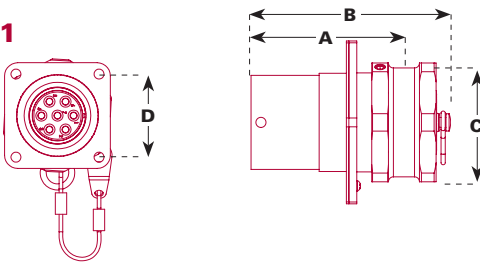

Panel mounted receptacle

A	B	C	D	Diameter
Length w/o cap	Length w/ cap	Width	Ctr. - ctr. mount hole	Mount hole
4.89	5.52	3.50	2.84	0.22

Base P/N
CEX172

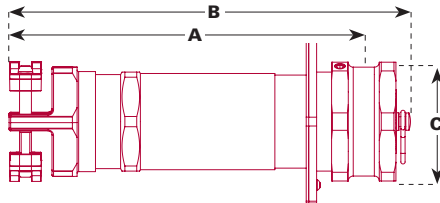

Cable mounted square flange receptacle with mechanical clamp

A	B	C	D	Diameter
Length w/o cap	Length w/ cap	Width	Ctr. - ctr. mount hole	Mount hole
9.50	10.13	3.50	2.84	0.22

Base P/N
CEX173

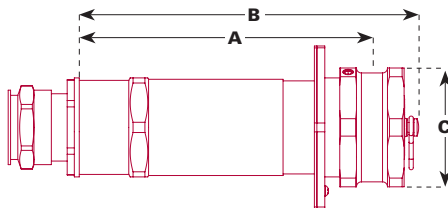

Cable mounted square flange receptacle with EX cable gland

A	B	C	D	Diameter
Length w/o cap	Length w/ cap	Width	Ctr. - ctr. mount hole	Mount hole
8.08	8.71	3.50	2.84	0.22

Base P/N
CEX174

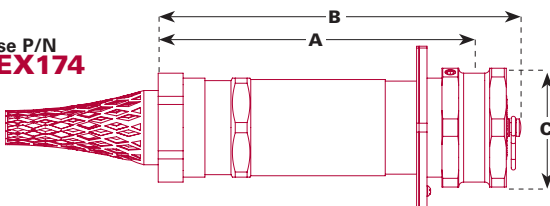

Cable mounted square flange receptacle with basketweave

A	B	C	D	Diameter
Length w/o cap	Length w/ cap	Width	Ctr. - ctr. mount hole	Mount hole
8.54	9.17	3.50	2.84	0.22

CEX series multi-pin– 28 Shell

Example: **CEX133D2839PN-01-BS**



Series

CEX	Hazardous rated
------------	-----------------

Base call out

13	Male plug
15	Female in-line
17	Female panel mount

Shell size

28	Connector shell size
C28	C length shell size

Cable hardware

1*	Panel mount
2*	Mechanical clamp
3	Eex d gland
4*	Basketweave cable grip

* Includes potting compound

Panel mount
leave blank if cable hardware #1 "Panel Mount" is selected

Cable gland
refer to the cable gland table below if cable hardware #3 "Eex d Gland" is selected

Grommet
refer to the grommet table below if cable hardware #2 or #4 option is selected

Grommet

	Cable diameter	
	in.	mm.
24	1.375 - 1.500	34.9 - 38.1
26	1.500 - 1.625	38.1 - 41.3
28	1.625 - 1.750	41.3 - 44.5
30	1.750 - 1.875	44.5 - 47.6
32	1.875 - 2.000	47.6 - 50.8
34	2.000 - 2.125	50.8 - 54.0
36	2.125 - 2.250	54.0 - 57.2
38	2.250 - 2.375	57.2 - 60.3
40	2.375 - 2.500	60.3 - 63.5
42	2.500 - 2.625	63.5 - 66.7
44	2.625 - 2.750	66.7 - 69.9
46	2.750 - 2.875	69.9 - 73.0

EX cable gland

	Unarmored min-max	Armored		
		Inner sheath	Outer sheath	Armor (max)
D	29.0-41.0	29.0-41.0	35.0-48.0	2.5
D2	35.0-45.0	35.0-48.0	42.0-56.0	2.5
E	42.0-56.0	42.0-53.0	50.0-65.0	2.5
F	50.0-65.0	50.0-62.5	58.0-74.0	2.5
G	58.0-74.0	58.0-74.0	66.0-83.0	3.2
G2	66.0-83.0	66.0-78.0	75.0-93.0	3.2

Contact amperage ratings

Contact size (AWG / MCM)	Non-circuit breaking current rating @ 55°C*
12 AWG	30
10 AWG	40
8 AWG	55
4/0 AWG	198
350 MCM	290

* Cable current rating must meet or exceed the ratings of the contacts to utilize connector at fully rated current.

NEC service voltage ratings

Service voltage	Non-circuit breaking	Circuit breaking
	DC volts RMS	AC volts RMS
A	250	240
D	600	600
E	600	600
B	600	600

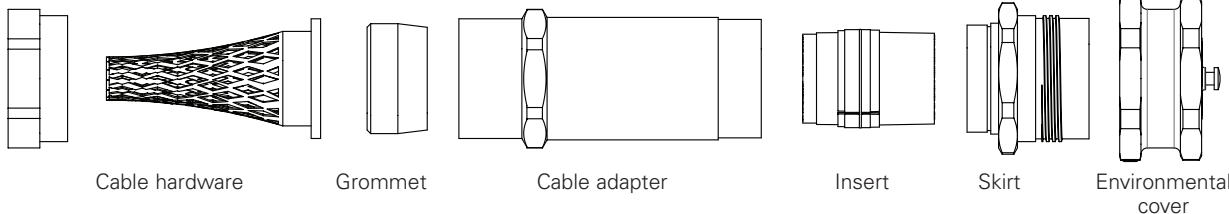

339 P N 01 BS

Contact gender

P	Male pin
S	Female socket

Termination method

N	Crimp
R	Pressure

Plating

BLANK	Silver (crimp or solder) Nickel (pressure)
K	Gold (crimp only)

Alternate key position

BLANK	0 degrees
--------------	-----------

See appendix p. 70 for clocking options

Series

BLANK	Unarmored
-BS	Armored & sheathed

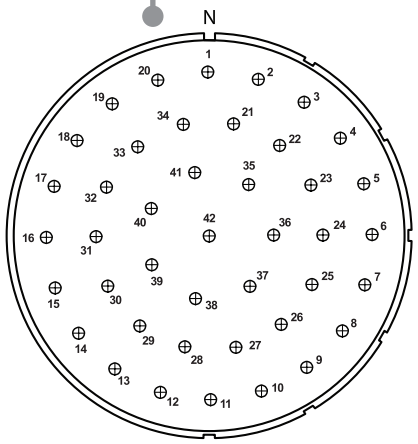

339

# Contacts	42
AWG	12
Service voltage rating	D

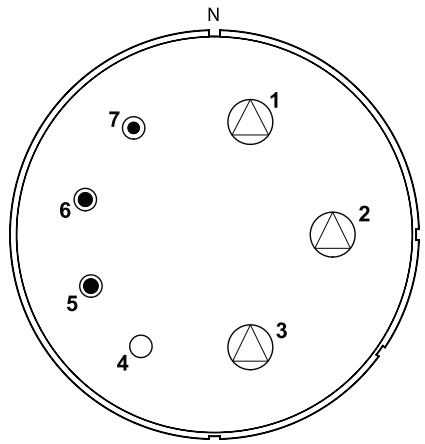

H44 (V.F.D. insert)

# Contacts	3	3	1
AWG	4/0	8	10
Service voltage rating	D		

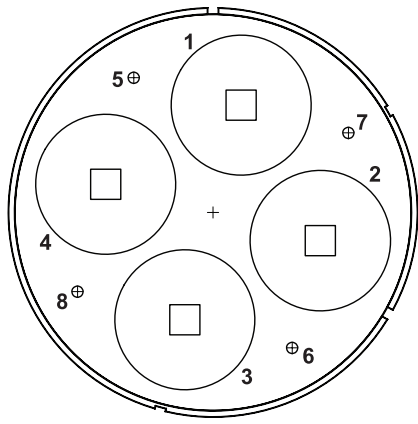

43

# Contacts	4	4
AWG	12	350 MCM
Service voltage rating	D (350 MCM)	E (12 AWG)

Contact Symbol	○	●	⊕	○	⊙	●	⊕	△	□	⊕	⊙	⊗	
AWG	18	16	12	10	8	4	1/0	4/0	313 MCM	350 MCM	444 MCM	535 MCM	777 MCM

C24 Shell

Applications:

Hazardous location control and instrumentation

Certifications:

- CE marked
- AEx listed for US Ex Zone 1 Applications (ETL)
- Listed for Canada Ex Zone 1 Applications (ETL)
- ATEX Group II Category 2 certified (ETL)
- IECEx Zone 1 Certified (ETL)
- EAc Certified (Russia)
- INMETRO Certified (Brazil)

Ambient temperature rating:

- Certified for use at: -60°C to +55°C

Environmental:

- IP66, IP68
- NEMA 4X, 6P

Construction:

- Contacts - silver plated copper, crimp style
- Shells - high tensile strength aluminum; hard anodic coating per MIL-A-8625, Type III, black color
- Rigid insulators - thermoplastic
- Resilient inserts - silicone rubber

Features & benefits:

- Reversible inserts are compatible with all panel mount, in-line, male and female shells
- Exclusive visual mating alignment
- Easily accessible wire terminals
- Ample wiring space within shells
- Reversible 8-point diamond cord grip relieves strain on conductors (patent pending)
- Suited for use with Type P cable
- EX cable glands available through Crouse-Hinds
- Hexagon shell design with easy wrenching surfaces ensures adequate torquing
- Impact-resistant



Cable mounted plug with mechanical clamp

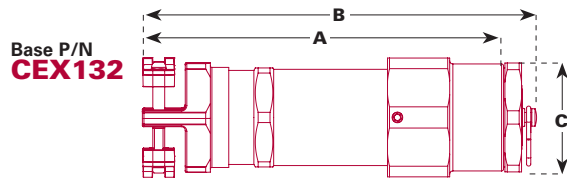

A	B	C
Length w/o cap	Length w/ cap	Width
9.64	10.50	3.25

Cable mounted plug with EX cable gland

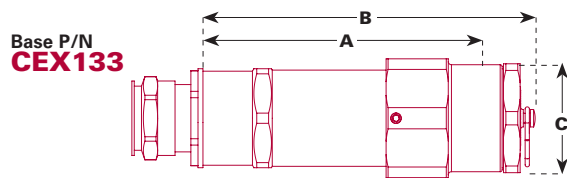

A	B	C
Length w/o cap	Length w/ cap	Width
8.21	9.07	3.25

Cable mounted plug with basketweave

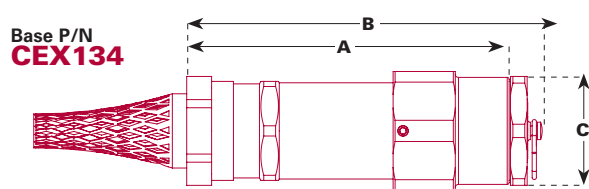

A	B	C
Length w/o cap	Length w/ cap	Width
8.68	9.54	3.50



Cable mounted receptacle with mechanical clamp

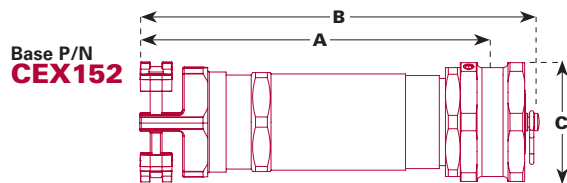

A	B	C
Length w/o cap	Length w/ cap	Width
10.00	10.63	3.50

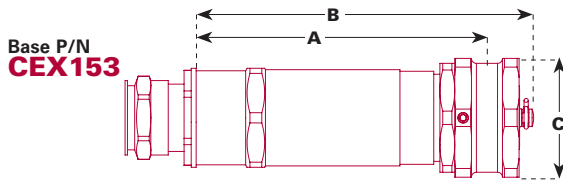

Cable mounted receptacle with EX cable gland

A	B	C
Length w/o cap	Length w/ cap	Width
8.58	9.21	3.5

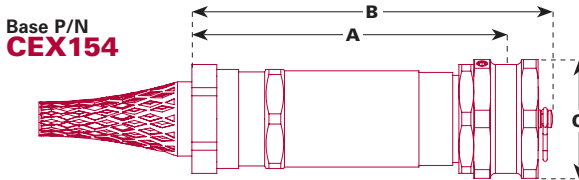

Cable mounted receptacle with basketweave

A	B	C
Length w/o cap	Length w/ cap	Width
9.04	9.67	3.50

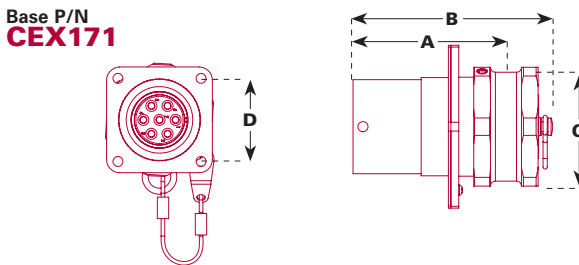

Panel mounted receptacle

A	B	C	D	Diameter
Length w/o cap	Length w/ cap	Width	Ctr. - ctr. mount hole	Mount hole
5.39	6.02	3.50	2.84	0.22

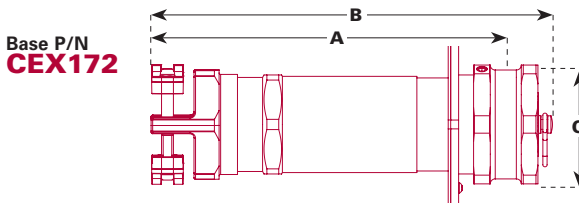

Cable mounted square flange receptacle with mechanical clamp

A	B	C	D	Diameter
Length w/o cap	Length w/ cap	Width	Ctr. - ctr. mount hole	Mount hole
10.00	10.63	3.50	2.84	0.22

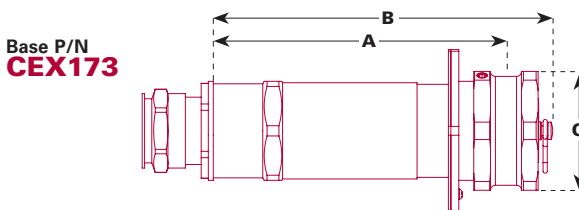

Cable mounted square flange receptacle with EX cable gland

A	B	C	D	Diameter
Length w/o cap	Length w/ cap	Width	Ctr. - ctr. mount hole	Mount hole
8.58	9.21	3.50	2.84	0.22

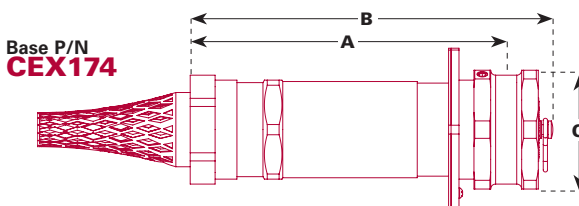

Cable mounted square flange receptacle with basketweave

A	B	C	D	Diameter
Length w/o cap	Length w/ cap	Width	Ctr. - ctr. Mount hole	Mount hole
9.04	9.67	3.50	2.84	0.22

CEX series single pole–C24 Shell

Example: **CEX-133-D-C24**

CEX 133 D C24

Series

CEX Hazardous rated

Base call out

13 Male plug
15 Female in-line
17 Female panel mount

Shell size

C24 Connector shell size

Cable hardware

1* Panel mount
2* Mechanical clamp
3 Eex d gland
4* Basketweave cable grip
 * Includes potting compound

Panel mount
 leave blank if cable hardware #1 "Panel Mount" is selected

Cable gland
 refer to the cable gland table below if cable hardware #3 "Eex d Gland" is selected

Grommet
 refer to the grommet table below if cable hardware #2 or #4 option is selected

EX cable gland				
	Unarmored min-max	Armored		
		Inner sheath	Outer sheath	Armor (max)
C2	23.0 - 34.0	23.0 - 34.0	29.0 - 41.0	2.0
D	29.0 - 41.0	29.0 - 41.0	35.0 - 48.0	2.5
D2	35.0 - 45.0	35.0 - 48.0	42.0 - 56.0	2.5
E	42.0 - 56.0	42.0 - 53.0	50.0 - 65.0	2.5
F	50.0 - 65.0	50.0 - 62.5	58.0 - 74.0	2.5

Grommet		
	Cable diameter	
	in.	mm.
BLANK	If R or N are chosen in "Cable Size/Entry" category above	
16	0.875 - 1.000	22.2 - 25.4
18	1.000 - 1.125	25.4 - 28.6
20	1.125 - 1.250	28.6 - 31.8
22	1.250 - 1.375	31.8 - 34.9
24	1.375 - 1.500	34.9 - 38.1
26	1.500 - 1.625	38.1 - 41.2
28	1.625 - 1.750	41.2 - 44.4
30	1.750 - 1.875	44.4 - 47.6

Contact amperage ratings

Contact size (AWG / MCM)	Non-circuit breaking current rating @ 55°C*
313 MCM	502
444 MCM	722
535 MCM	815
777 MCM	1030

* Cable current rating must meet or exceed the ratings of the contacts to utilize connector at fully rated current.

Service voltage ratings

Service voltage	Non-circuit breaking	
	DC volts RMS	Circuit breaking AC volts RMS
A	250	240
D	600	600
E	600	600
B	600	600

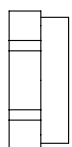

Cable hardware

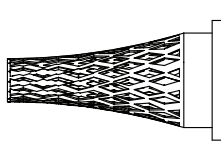

Grommet

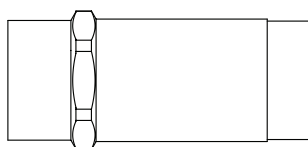

Cable adapter

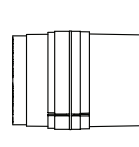

Insert

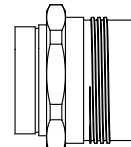

Skirt

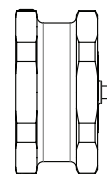

Environmental cover

313

P

N

BS

Contact gender

P	Male pin
S	Female socket

Termination method

N	Crimp
----------	-------

Series

BLANK	Unarmored
-BS	Armored & sheathed

313

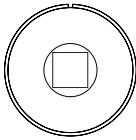

# Contacts	1
AWG	313 MCM
Service voltage rating	1000V
Current rating	502A

444

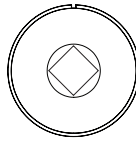

# Contacts	1
AWG	444 MCM
Service voltage rating	1000V
Current rating	722A

535

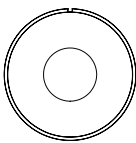

# Contacts	1
AWG	535 MCM
Service voltage rating	1000V
Current rating	815A

386

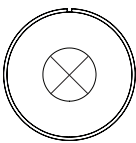

# Contacts	1
AWG	777 MCM
Service voltage rating	1000V
Current rating	1030A

Contact Symbol	○	●	⊕	○	⊙	●	⊕	⊖	⊖	⊖	⊖	⊖	⊖
AWG	18	16	12	10	8	4	1/0	4/0	313 MCM	444 MCM	535 MCM	777 MCM	

CZ & CRIG Series

Multi-pin and single pole connectors for harsh and heavy industrial areas

Individual components



Individual components – cable grip

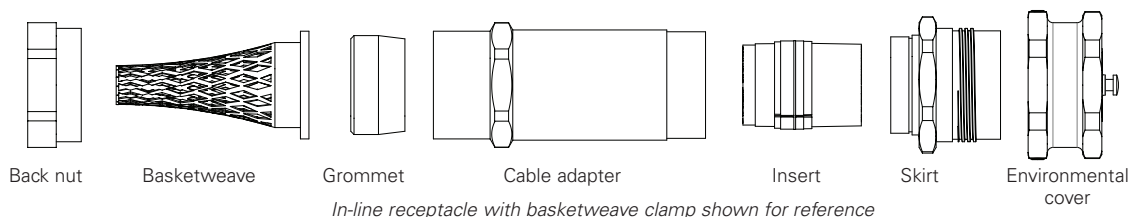

Cable grip components

Shell size	Grommet code	Cable diameter		Grommet part #	Washer part #	Basketweave part #		
		in.	mm.					
12	03	0.125	0.188	3.1	4.8	CZP-6312-3C	CZP-8012-4E	CZP-5012-4E
12	04	0.188	0.250	3.2	6.4	CZP-6312-4C	CZP-8012-4E	CZP-5012-4E
12	06	0.250	0.375	6.4	9.5	CZP-6312-6C	CZP-8012-8E	CZP-5012-6E
12	08	0.375	0.500	9.5	12.7	CZP-6312-8C		CZP-5012-8E
12	10	0.500	0.625	12.7	15.9	CZP-6312-10C	CZP-8016-12E	CZP-5012-10E
12	12	0.625	0.750	15.9	19.1	CZP-6312-12C		CZP-5012-12E
12	14	0.750	0.875	19.1	22.2	CZP-6312-14C	CZP-8012-15E	CZP-5012-14E
16	08	0.375	0.500	9.5	12.7	CZP-6316-8C	CZP-8016-8E	CZP-5016-8E
16	10	0.500	0.625	12.7	15.9	CZP-6316-10C	CZP-8016-12E	CZP-5016-10E
16	12	0.625	0.750	15.9	19.1	CZP-6316-12C		CZP-5016-12E
16	14	0.750	0.875	19.1	22.2	CZP-6316-14C	CZP-8016-16E	CZP-5016-14E
16	16	0.875	1.000	22.2	25.4	CZP-6316-16C		CZP-5016-16E
16	18	1.000	1.125	25.4	28.6	CZP-6316-18C	CZP-8016-20E	CZP-5016-18E
16	20	1.125	1.250	28.6	31.8	CZP-6316-20C		CZP-5016-20E
20	10	0.500	0.625	12.7	15.9	CZP-6320-10C	CZP-8020-12E	CZP-5020-10E
20	12	0.625	0.750	15.9	19.1	CZP-6320-12C		CZP-5020-12E
20	14	0.750	0.875	19.1	22.2	CZP-6320-14C	CZP-8020-16E	CZP-5020-14E
20	16	0.875	1.000	22.2	25.4	CZP-6320-16C		CZP-5020-16E
20	18	1.000	1.125	25.4	28.6	CZP-6320-18C	CZP-8020-20E	CZP-5020-18E
20	20	1.125	1.250	28.6	31.8	CZP-6320-20C		CZP-5020-20E
20	22	1.250	1.375	31.8	34.9	CZP-6320-22C	CZP-8020-24E	CZP-5020-22E
20	24	1.375	1.500	34.9	38.1	CZP-6320-24C		CZP-5020-24E
20	26	1.500	1.625	38.1	41.3	CZP-6320-26C	CZP-8020-28E	CZP-5020-26E
24	16	0.875	1.000	22.2	25.4	CZP-6324-16C	CZP-8024-16E	CZP-5024-16E
24	18	1.000	1.125	25.4	28.6	CZP-6324-18C	CZP-8024-20E	CZP-5024-18E
24	20	1.125	1.250	28.6	31.8	CZP-6324-20C		CZP-5024-20E
24	22	1.250	1.375	31.8	34.9	CZP-6324-22C	CZP-8024-24E	CZP-5024-22E
24	24	1.375	1.500	34.9	38.1	CZP-6324-24C		CZP-5024-24E
24	26	1.500	1.625	38.100	41.200	CZP-6324-26C	CZP-8024-28E	CZP-5024-26C
24	28	1.625	1.750	41.275	44.450	CZP-6324-28C		CZP-5024-28C
24	30	1.750	1.875	44.400	47.620	CZP-6324-30C	CZP-8024-32E	CZP-5024-30C
28	24	1.375	1.500	34.925	38.100	CZP-6328-24C	CZP-8028-24E	CZP-5028-28E
28	26	1.500	1.625	38.100	41.275	CZP-6328-26C	CZP-8028-28E	CZP-5028-28E
28	28	1.625	1.750	41.275	44.450	CZP-6328-28C		CZP-5028-28E
28	30	1.750	1.875	44.450	47.625	CZP-6328-30C	CZP-8028-32E	CZP-5028-32E
28	32	1.875	2.000	47.625	50.800	CZP-6328-32C		CZP-5028-32E
28	34	2.000	2.125	50.800	53.975	CZP-6328-34C	CZP-8028-36E	CZP-5028-36E
28	36	2.125	2.250	53.975	57.150	CZP-6328-36C		CZP-5028-36E
28	38	2.250	2.375	57.150	60.325	CZP-6328-38C	CZP-8028-40E	CZP-5028-40E
28	40	2.375	2.500	60.325	63.500	CZP-6328-40C		CZP-5028-40E
28	42	2.500	2.625	63.500	66.675	CZP-6328-42C	CZP-8028-44E	CZP-5028-46E
28	44	2.625	2.750	66.675	69.850	CZP-6328-44C		CZP-5028-46E
28	46	2.750	2.875	69.850	73.025	CZP-6328-46C	CZP-8028-46E	CZP-5028-46E

Individual components – skirts, covers & contacts

Male environmental covers

Shell size	Part #	
	Ring and chain	Eyelet and chain
12	CZP-W-5512-A	CZP-WF-5512-A
16	CZP-W-5516-A	CZP-WF-5516-A
20	CZP-W-5520-A	CZP-WF-5520-A
24	CZP-W-5524-A	CZP-WF-5524-A
C24	CZP-C-5524-A	CZP-CF-5524-A
28	CZP-W-5528-A	CZP-WF-5528-A

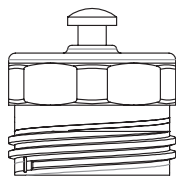

Female environmental covers

Shell size	Part #	
	Ring and chain	Eyelet and chain
12	CZP-W-5612-A	CZP-WF-5612-A
16	CZP-W-5616-A	CZP-WF-5616-A
20	CZP-W-5620-A	CZP-WF-5620-A
24	CZP-W-5624-A	CZP-WF-5624-A
28	CZP-W-5628-A	CZP-WF-5628-A

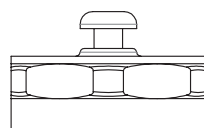

Female square flange skirts

Shell size	Part #
12	CZP-WO-1712-200
16	CZP-WO-1716-200
20	CZP-WO-1720-200
24	CZP-WO-1724-200
C24	CZP-CO-1724-200
28	CZP-WO-1728-200

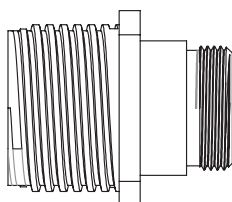

Male skirts

Shell size	Part #
12	CZP-W-1312-200
16	CZP-W-1316-200
20	CZP-W-1320-200
24	CZP-W-1324-200
C24	CZP-C-1324-200
C24	CZP-C-1324-200-KL (keyless option)
28	CZP-W-1328-200

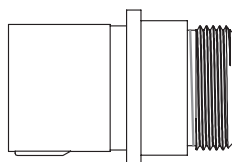

Female in-line skirts

Shell size	Part #
12	CZP-WO-1512-200
16	CZP-WO-1516-200
20	CZP-WO-1520-200
24	CZP-WO-1524-200
C24	CZP-CO-1524-200
28	CZP-WO-1528-200

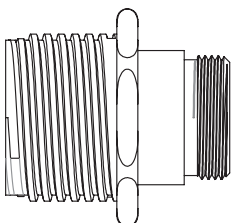

Individual contacts

Contact size (AWG)	Type	Part #	
		Standard	Ground
16	Pin	CZP-4016-36L	CZP-4016-37L
16	Socket	CZP-4116-36L	–
12	Pin	CZP-4012-36L	CZP-4012-37L3
12	Socket	CZP-4112-36L	–
10	Pin	CZP-4010-36L	CZP-4010-37L2
10	Socket	CZP-4110-36L	–
8	Pin	CZP-4008-66L	–
8	Socket	CZP-4108-66L	–
4	Pin	CZP-4004-66L	–
4	Socket	CZP-4104-66L	–



Female socket

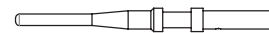

Male pin

Individual components – adapters & nuts

Cable adapters

Shell size	Part #	
	Standard	Long
12	CZP-W-2012	CZP-W-2412
16	CZP-W-2016	CZP-W-2416
20	CZP-W-2020	CZP-W-2420
24	CZP-W-2024	CZP-W-2424
28	CZP-W-2028	CZP-W-2428

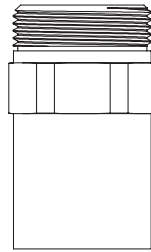

Mechanical clamp nuts

Shell size	Part #
12	CZP-W-5312
16	CZP-W-5316
20	CZP-W-5320
24	CZP-W-5324
28	CZP-W-5328

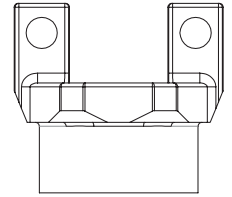

Panel board adapters

Shell size	Part #
12	CZP-W-2112
16	CZP-W-2116
20	CZP-W-2120
24	CZP-W-2124
28	CZP-W-2128



Mechanical clamp nuts

Shell size	Part #
12	CZP-W-5312
16	CZP-W-5316
20	CZP-W-5320
24	CZP-W-5324
28	CZP-W-5328

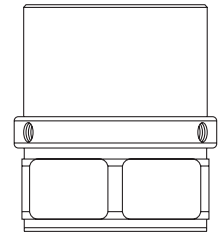

Coupling nuts

Shell size	Part #
12	CZP-7012-10A
16	CZP-7016-10A
20	CZP-7020-10A
24	CZP-7024-10A
28	CZP-7028-10A

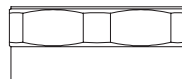

Insert kits

See pages 56-57 for part numbers

Insert clamp nuts

Shell size	Part #
12	CZP-W-7512
16	CZP-W-7516
20	CZP-W-7520
24	CZP-W-7524
28	CZP-W-7528

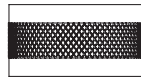

Gland nuts

Shell size	Part #
12	CZP-W-7312-10A
16	CZP-W-7316-10A
20	CZP-W-7320-10A
24	CZP-W-7324-10A
28	CZP-W-7328-10A

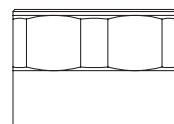

Jack nuts

Shell size	Part #
12	CZP-7012-30A
16	CZP-7016-30A
20	CZP-7020-30A
24	CZP-7024-30A
28	CZP-7028-30A

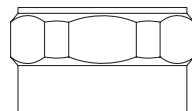

Male insert kit

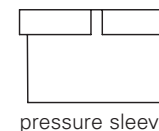
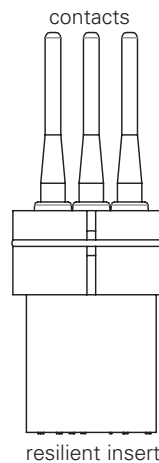
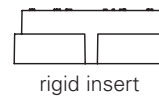

Female insert kit

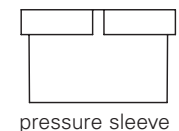
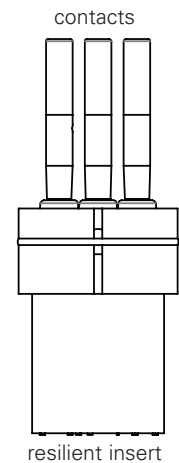
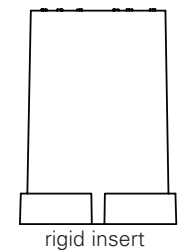

Individual components – insert options

- Insert kits include plastic interior components and all contacts

Number of contacts	*Part #	Male suffix #	Female suffix #	Shell size	313 MCM (120)	444 MCM (185)	500 MCM (240)	646-777 MCM (300-400)	Voltage	CRIG page #	CEX page #
1	CRIG-C24-313	-PN	-SN	C24	1	–	–	–	1000V	32	58
	CRIG-C24-386	-PN	-SN	C24	–	–	–	1	1000V	32	58
	CRIG-C24-444	-PN	-SN	C24	–	1	–	–	1000V	32	58
	CRIG-C24-535	-PN	-SN	C24	–	–	1	–	1000V	32	58

* Insert H for multi-lam style contact (-H535)

Number of contacts	Part #	Male suffix #	Female suffix #	Shell size	16 AWG (1.5)	12 AWG (4.0)	10 AWG (6.0)	8 AWG (10.0)	Voltage	CZ page #	CEX page #
3	CZP-12-327	-PN	-SN	12	–	3	–	–	D	12	38
	CZP-12-330	-PN	-SN	12	–	3	–	–	D	12	38

Number of contacts	Part #	Male suffix #	Female suffix #	Shell size	16 AWG (1.5)	10 AWG (6.0)	8 AWG (10.0)	4 AWG (25.0)	1/0 AWG (55.0)	4/0 AWG (120.0)	Voltage	CZ page #	CEX page #
4	CZP-12-314	-PN	-SN	12	–	4	–	–	–	–	D	12	38
	CZP-12-316	-PN	-SN	12	–	4	–	–	–	–	D	12	38
	CZP-12-322	-PN	-SN	12	–	4	–	–	–	–	D	12	38
	CZP-12-333	-PN	-SN	12	4	–	–	–	–	–	D	12	38
	CZP-16-322	-PN	-SN	16	–	–	4	–	–	–	D	16	42
	CZP-16-328	-PN	-SN	16	–	–	4	–	–	–	D	16	42
	CZP-16-38	-PN	-SN	16	–	–	4	–	–	–	D	16	42
	CZP-20-40	-PN	-SN	C20	–	–	–	–	4	–	D	20	46
	CZP-C24-26	-PN	-SN	C24	–	–	–	–	–	4	D	24	50
CZP-C24-38	-PN	-SN	C24	–	–	–	–	–	4	D	24	50	

Number of contacts	Part #	Male suffix #	Female suffix #	Shell size	16 AWG (1.5)	12 AWG (4.0)	10 AWG (6.0)	8 AWG (10.0)	4/0 AWG (120.0)	Voltage	CZ page #	CEX page #
5	CZP-12-324	-PN	-SN	12	–	5	–	–	–	D	12	38
	CZP-C24-48	-PN	-SN	C24	–	2	–	–	3	A (12 AWG) D (4/0 AWG)	24	50

Number of contacts	Part #	Male suffix #	Female suffix #	Shell size	16 AWG (1.5)	12 AWG (4.0)	10 AWG (6.0)	8 AWG (10.0)	4/0 AWG (120.0)	Voltage	CZ page #	CEX page #
7	CZP-12-310	-PN	-SN	12	–	7	–	–	–	A	12	38
	CZP-12-348	-PN	-SN	12	7	–	–	–	–	A	12	38
	CZP-12-354	-PN	-SN	12	–	7	–	–	–	A	12	38
	CZP-16-378	-PN	-SN	16	7	–	–	–	–	D	16	42
	CZP-20-359	-PN	-SN	20	–	–	–	7	–	E	20	46
	CZP-28-H44	-PN	-SN	28	–	–	1	3	3	D	28	54

Number of contacts	Part #	Male suffix #	Female suffix #	Shell size	12 AWG (4.0)	1/0 AWG (55.0)	350 MCM (10.0)	Voltage	CZ page #	CEX page #
8	CZP-C28-43	-PN	-SN	C28	4	–	4	D (350 MCM); E (12 AWG)	28	54
	CZP-C24-53	-PN	-SN	C24	4	4	–	A (12 AWG); B (1/0 AWG)	24	50

Number of contacts	Part #	Male suffix #	Female suffix #	Shell size	16 AWG (1.5)	12 AWG (4.0)	10 AWG (6.0)	8 AWG (10.0)	Voltage	CZ page #	CEX page #
10	CZP-12-334	-PN	-SN	12	10	–	–	–	A	12	38
	CZP-12-355	-PN	-SN	12	10	–	–	–	A	12	38
	CZP-16-376	-PN	-SN	16	–	6	4	–	D	16	42
	CZP-16-381	-PN	-SN	16	–	6	4	–	D	16	42

Number of contacts	Part #	Male suffix #	Female suffix #	Shell size	16 AWG (1.5)	12 AWG (4.0)	10 AWG (6.0)	8 AWG (10.0)	Voltage	CZ page #	CEX page #
12	CZP-20-375	-PN	-SN	20	–	–	12	–	D	20	46

Number of contacts	Part #	Male suffix #	Female suffix #	Shell size	16 AWG (1.5)	12 AWG (4.0)	10 AWG (6.0)	8 AWG (10.0)	Voltage	CZ page #	CEX page #
16	CZP-16-325	-PN	-SN	16	16	–	–	–	D	16	42

Individual components – insert options

- Insert kits include plastic interior components and all contacts

Number of contacts	Part #	Male suffix #	Female suffix #	Shell size	16 AWG (1.5)	12 AWG (4.0)	10 AWG (6.0)	8 AWG (10.0)	Voltage	CZ page #	CEX page #
19	CZP-16-312	-PN	-SN	16	–	19	–	–	A	16	42
	CZP-16-355	-PN	-SN	16	19	–	–	–	A	16	42
	CZP-16-377	-PN	-SN	16	–	19	–	–	A	16	42
	CZP-20-376	-PN	-SN	20	–	19	–	–	D	20	46
	CZP-20-388	-PN	-SN	20	–	19	–	–	D	20	46

Number of contacts	Part #	Male suffix #	Female suffix #	Shell size	16 AWG (1.5)	12 AWG (4.0)	10 AWG (6.0)	8 AWG (10.0)	Voltage	CZ page #	CEX page #
20	CZP-20-332	-PN	-SN	20	–	20	–	–	B Center, A Outer	20	46
	CZP-20-334	-PN	-SN	20	16	–	–	4	D	20	46
	CZP-20-387	-PN	-SN	20	–	20	–	–	B Center, A Outer	20	46

Number of contacts	Part #	Male suffix #	Female suffix #	Shell size	16 AWG (1.5)	12 AWG (4.0)	10 AWG (6.0)	8 AWG (10.0)	Voltage	CZ page #	CEX page #
22	CZP-20-331	-PN	-SN	20	20	–	–	2	E (8 AWG) D (16 AWG)	20	46

Number of contacts	Part #	Male suffix #	Female suffix #	Shell size	16 AWG (1.5)	12 AWG (4.0)	10 AWG (6.0)	8 AWG (10.0)	Voltage	CZ page #	CEX page #
27	CZP-16-335	-PN	-SN	16	24	3	–	–	A	16	42

Number of contacts	Part #	Male suffix #	Female suffix #	Shell size	16 AWG (1.5)	12 AWG (4.0)	10 AWG (6.0)	8 AWG (10.0)	Voltage	CZ page #	CEX page #
37	CZP-16-321	-PN	-SN	16	37	–	–	–	A	16	42
	CZP-20-350	-PN	-SN	20	–	37	–	–	A	20	46
	CZP-20-386	-PN	-SN	20	–	37	–	–	A	20	46
	CZP-24-371	-PN	-SN	24	37	–	–	–	D	24	50

Number of contacts	Part #	Male suffix #	Female suffix #	Shell size	16 AWG (1.5)	12 AWG (4.0)	10 AWG (6.0)	8 AWG (10.0)	Voltage	CZ page #	CEX page #
42	CZP-28-339	-PN	-SN	28	–	42	–	–	D	28	54

Number of contacts	Part #	Male suffix #	Female suffix #	Shell size	16 AWG (1.5)	12 AWG (4.0)	10 AWG (6.0)	8 AWG (10.0)	Voltage	CZ page #	CEX page #
47	CZP-20-354	-PN	-SN	20	45	–	–	2	D (8 AWG) A (16 AWG)	20	46

Number of contacts	Part #	Male suffix #	Female suffix #	Shell size	16 AWG (1.5)	12 AWG (4.0)	10 AWG (6.0)	8 AWG (10.0)	Voltage	CZ page #	CEX page #
58	CZP-24-352	-PN	-SN	24	–	58	–	–	A	24	50
	CZP-24-384	-PN	-SN	24	–	58	–	–	A	24	50

Number of contacts	Part #	Male suffix #	Female suffix #	Shell size	16 AWG (1.5)	12 AWG (4.0)	10 AWG (6.0)	8 AWG (10.0)	Voltage	CZ page #	CEX page #
68	CZP-20-313	-PN	-SN	20	68	–	–	–	A	20	46

Number of contacts	Part #	Male suffix #	Female suffix #	Shell size	16 AWG (1.5)	12 AWG (4.0)	10 AWG (6.0)	8 AWG (10.0)	Voltage	CZ page #	CEX page #
100	CZP-16-313	-PN	-SN	16	100	–	–	–	D	24	50

Individual components – cable glands



EX cable gland size reference

	EX cable gland			
	Unarmored sheath	Armored		
		Inner sheath	Outer sheath	Armor (max)
A1	4.0 - 8.5	4.5 - 8.0	7.0 - 12.0	0.9
A2	7.0 - 12.0	7.0 - 12.0	10.5 - 16.0	1.3
A	10.0 - 16.0	10.0 - 15.5	13.5 - 21.0	1.3
B	13.5 - 20.5	13.5 - 20.5	18.0 - 27.5	1.6
C	18.0 - 27.5	18.0 - 27.5	23.0 - 34.0	1.6
C2	23.0 - 34.0	23.0 - 34.0	29.0 - 41.0	2.0
D	29.0 - 41.0	29.0 - 41.0	35.0 - 48.0	2.5
D2	35.0 - 45.0	35.0 - 48.0	42.0 - 56.0	2.5
E	42.0 - 56.0	42.0 - 53.0	50.0 - 65.0	2.5
F	50.0 - 65.0	50.0 - 62.5	58.0 - 74.0	2.5
G	58.0 - 74.0	58.0 - 74.0	66.0 - 83.0	3.2
G2	66.0 - 83.0	66.0 - 78.0	75.0 - 93.0	3.2

Unarmored glands

- Individual components available for order by authorized ATEX certified distributor only

Shell size	Gland size	Sealing washer part #	Unarmored cable gland part#	Reducer part #	Sealing washer reducer part #
12	A1	SWZ600005	ADE1M201NPS -1F2	CAP740294	SWZ600004
	A2		ADE1M251NPS -1F2	–	–
	A		ADE1M252NPS -1F2	–	–
	B		ADE1M253NPS -1F2	–	–
	C		ADE1M323NPS -1F2	CAP740814	SWZ600006
16	A	SWZ600007	ADE1M252NPS -1F2	CAP740574	SWZ600005
	B		ADE1M253NPS -1F2		
	C		ADE1M323NPS -1F2	CAP740834	SWZ600006
	C2		ADE1M403NPS -1F2	–	–
	D		ADE1M501NPS -1F2	CAP741354	SWZ600008
20 & C20	A	SWZ600008	ADE1M252NPS -1F2	CAP740584	SWZ600005
	B		ADE1M253NPS -1F2	CAP740584	SWZ600005
	C		ADE1M323NPS -1F2	CAP740844	SWZ600006
	C2		ADE1M403NPS -1F2	CAP741104	SWZ600007
	D		ADE1M501NPS -1F2	–	–
	D2		ADE1M502NPS -1F2	–	–
	E		ADE1M633NPS -1F2	CAP741624	SWZ600009
24 & C24	C2	SWZ600009	ADE1M403NPS -1F2	CAP741114	SWZ600007
	D		ADE1M501NPS -1F2	CAP741374	SWZ600008
	D2		ADE1M502NPS -1F2	CAP741374	SWZ600008
	E		ADE1M633NPS -1F2	–	–
	F		ADE1M753NPS -1F2	CAP741894	SWZ600010
28	D	SWZ600010	ADE1M501NPS -1F2	CAP741384	SWZ600008
	D2		ADE1M502NPS -1F2	CAP741384	SWZ600008
	E		ADE1M633NPS -1F2	CAP741664	SWZ600009
	F		ADE1M753NPS -1F2	–	–
	G		ADE1M902NPS -1F2	CAP745394	SWZ600013
	G2		ADE1M903NPS -1F2	CAP745394	SWZ600013

Individual components – cable glands

Armored glands

- Individual components available for order by authorized ATEX certified distributor only

Shell size	Gland size	Sealing washer part #	Armored cable gland part #	Reducer part #	Sealing washer reducer part #
12	A1	SWZ600005	ADE4M201NPS -4F	CAP740294	SWZ600004
	A2		ADE4M251NPS -4F	–	–
	A		ADE4M252NPS -4F	–	–
	B		ADE4M253NPS -4F	–	–
	C		ADE4M323NPS -4F	CAP740814	SWZ600006
16	A	SWZ600007	ADE4M252NPS -4F	CAP740574	SWZ600005
	B		ADE4M253NPS -4F		
	C		ADE4M402NPS -4F	–	–
	C2		ADE4M403NPS -4F	–	–
	D		ADE4M503NPS -4F	CAP741354	SWZ600008
20 & C20	A	SWZ600008	ADE4M252NPS -4F	CAP740584	SWZ600005
	B		ADE4M253NPS -4F	CAP740584	SWZ600005
	C		ADE4M323NPS -4F		
	C2		ADE4M502NPS -4F	–	–
	D		ADE4M503NPS -4F	–	–
	D2		ADE4M632NPS -4F	CAP741624	SWZ600009
	E		ADE4M633NPS -4F	CAP741624	SWZ600009
24 & C24	C2	SWZ600009	ADE4M502NPS -4F	CAP741374	SWZ600008
	D		ADE4M503NPS -4F		
	D2		ADE4M632NPS -4F	–	–
	E		ADE4M633NPS -4F	–	–
	F		ADE4M753NPS -4F	CAP741894	SWZ600010
	G		ADE4M901NPS -4F	CAP745394	SWZ600013
28 & C28	D	SWZ600010	ADE4M503NPS -4F	CAP741384	SWZ600008
	D2		ADE4M632NPS -4F	CAP741664	SWZ600009
	E		ADE4M633NPS -4F	CAP741664	SWZ600009
	F		ADE4M753NPS -4F	–	–
	G		ADE4M901NPS -4F	CAP745394	SWZ600013
	G2		ADE4M902NPS -4F	CAP745394	SWZ600013

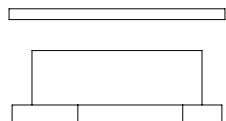

Full gland assembly



Sealing washer

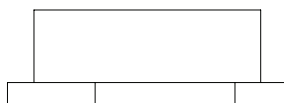

Reducer

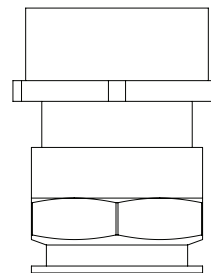

Cable gland

Appendix



Appendix

Tool reference

Crimp tools



Contact size	Crimp tool part #	Die part #
16 AWG	CH300-25A	CH682-1
12 AWG	CH300-25A	CH684-1 - Socket CH683-1 - Pin
10 AWG	CH300-25A	CH684-1

Insertion and removal tools



Contact size	Removal tool part #	Insertion tool part #
8 AWG	CH2-8250	CH1265
10 AWG	CH2-8250	CH1205
12 AWG	CH2-8250	CH1000-12
16 AWG	CH2-8250	CH1000-16

T & B Hydraulic crimp tools*

Contact size	Crimper head part #	Die part #
8 AWG	13100A	15520
313 MCM	13100A	15512
444 MCM	13100A	15505
535 MCM	13100A	15515
777 MCM	13100A	15504

*Hydraulic crimp tools not available through Crouse-Hinds.

Appendix

Insert index

Part #	Shell size	Number of contacts	313 MCM (120)	444 MCM (185)	500 MCM (240)	646-777 MCM (300-400)	Voltage	CZ page #	CEX page #
CRIG-C24-313	C24	1	1	–	–	–	1000V	32	58
CRIG-C24-386	C24	1	–	–	–	1	1000V	32	58
CRIG-C24-444	C24	1	–	1	–	–	1000V	32	58
CRIG-C24-535	C24	1	–	–	1	–	1000V	32	58

Part #	Shell size	Number of contacts	16 AWG (1.5)	12 AWG (14.0)	10 AWG (6.0)	8 AWG (10.0)	4 AWG (25.0)	1/0 AWG (55.0)	4/0 AWG (120.0)	Voltage	CZ page #	CEX page #
CZP-12-327	12	3	–	3	–	–	–	–	–	D	12	38
CZP-12-330	12	3	–	3	–	–	–	–	–	D	12	38
CZP-12-314	12	4	–	–	4	–	–	–	–	D	12	38
CZP-12-316	12	4	–	–	4	–	–	–	–	D	12	38
CZP-12-333	12	4	4	–	–	–	–	–	–	D	12	38
CZP-12-322	12	4	–	–	4	–	–	–	–	D	12	38
CZP-16-322	16	4	–	–	–	–	4	–	–	D	16	42
CZP-16-328	16	4	–	–	–	4	–	–	–	D	16	42
CZP-16-38	16	4	–	–	–	–	4	–	–	D	16	42
CZP-C20-40	C20	4	–	–	–	–	–	4	–	D	20	46
CZP-C24-26	C24	4	–	–	–	–	–	–	4	D	24	50
CZP-C24-38	C24	4	–	–	–	–	–	–	4	D	24	50
CZP-12-324	12	5	–	5	–	–	–	–	–	D	12	38
CZP-C24-48	C24	5	–	2	–	–	–	–	3	A 12 AWG, D 4/0 AWG	24	50
CZP-12-310	12	7	–	7	–	–	–	–	–	A	12	38
CZP-12-348	12	7	7	–	–	–	–	–	–	A	12	38
CZP-12-354	12	7	–	7	–	–	–	–	–	A	12	38
CZP-16-378	16	7	–	–	–	–	–	–	–	D	16	42
CZP-20-359	20	7	–	–	–	7	–	–	–	E	20	46
CZP-28-H44	C28	7	–	–	1	3	–	–	3	D	28	54
CZP-12-334	12	10	10	–	–	–	–	–	–	A	12	38
CZP-12-355	12	10	10	–	–	–	–	–	–	A	12	38
CZP-16-376	16	10	–	6	4	–	–	–	–	D	16	42
CZP-16-381	16	10	–	6	4	–	–	–	–	D	16	42
CZP-20-375	20	12	–	–	12	–	–	–	–	D	20	46
CZP-16-325	16	16	16	–	–	–	–	–	–	D	16	42
CZP-16-312	16	19	–	19	–	–	–	–	–	A	16	42
CZP-16-355	16	19	19	–	–	–	–	–	–	A	16	42
CZP-16-377	16	19	–	19	–	–	–	–	–	A	16	42
CZP-20-376	20	19	–	19	–	–	–	–	–	D	20	46
CZP-20-388	20	19	–	19	–	–	–	–	–	D	20	46
CZP-20-332	20	20	–	20	–	–	–	–	–	B Center, A Outer	20	46
CZP-20-334	20	20	16	–	–	4	–	–	–	D	20	46
CZP-20-387	20	20	–	20	–	–	–	–	–	B Center, A Outer	20	46
CZP-20-331	20	22	20	–	–	2	–	–	–	E 8 AWG, D 16 AWG	20	46
CZP-16-335	16	27	24	3	–	–	–	–	–	A	16	42
CZP-16-321	16	37	37	–	–	–	–	–	–	A	16	42
CZP-20-350	20	37	–	37	–	–	–	–	–	A	20	46
CZP-20-386	20	37	–	37	–	–	–	–	–	A	20	46
CZP-24-371	24	37	37	–	–	–	–	–	–	D	24	50
CZP-28-339	28	42	–	42	–	–	–	–	–	D	28	–
CZP-20-354	20	47	45	–	–	2	–	–	–	D 8 AWG, A 16 AWG	20	46
CZP-24-352	24	58	–	58	–	–	–	–	–	A	24	50
CZP-24-384	24	58	–	58	–	–	–	–	–	A	24	50
CZP-20-313	20	68	68	–	–	–	–	–	–	A	20	46

Inserts – 12 shell clocking options and ground contact location

Example: CZ-PEKL-0812-314PN-01

● Alternate key position

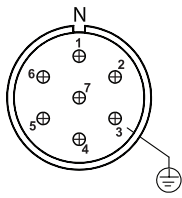

310

Key position
(add to end of part number)

No rotations

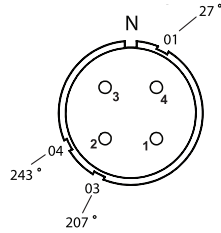

314

Key position
(add to end of part number)

01 27°	04 243°
03 207°	

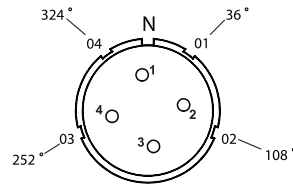

316

Key position
(add to end of part number)

01 36°	03 252°
02 108°	04 324°

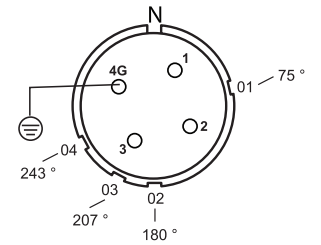

322

Key position
(add to end of part number)

01 75°	03 207°
02 180°	04 243°

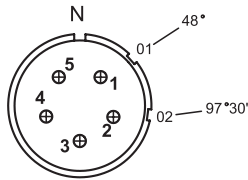

324

Key position
(add to end of part number)

01 48°	02 97° 30'
--------	------------

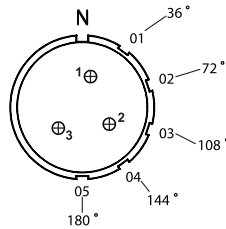

327

Key position
(add to end of part number)

01 36°	04 144°
02 72°	05 180°
03 108°	

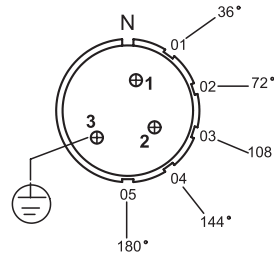

330

Key position
(add to end of part number)

01 36°	04 144°
02 72°	05 180°
03 108°	

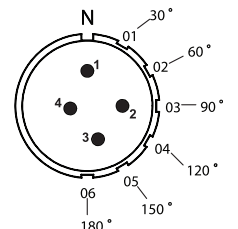

333

Key position
(add to end of part number)

01 30°	04 120°
02 60°	05 150°
03 90°	06 180°

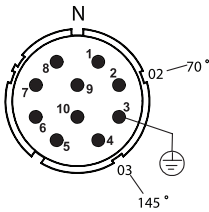

334

Key position
(add to end of part number)

02 70°	03 145°
--------	---------

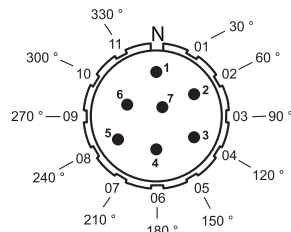

348

Key position
(add to end of part number)

01 30°	05 150°	09 270°
02 60°	06 180°	10 300°
03 90°	07 210°	11 330°
04 120°	08 240°	

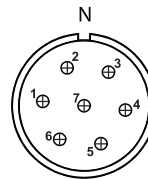

354

Key position
(add to end of part number)

No rotations

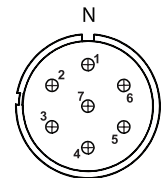

354D

Key position
(add to end of part number)

No rotations

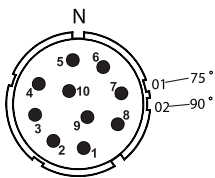

355

Key position
(add to end of part number)

01 75°	02 90°
--------	--------

Inserts – 16 shell clocking options and ground contact location

Example: [CZ-PEKL-1016-321PN-01](#)

● Alternate key position

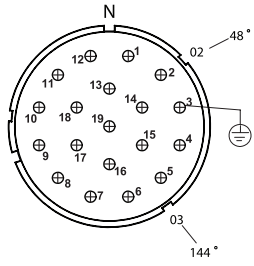

312

Key position <i>(add to end of part number)</i>	
02 48°	03 144°

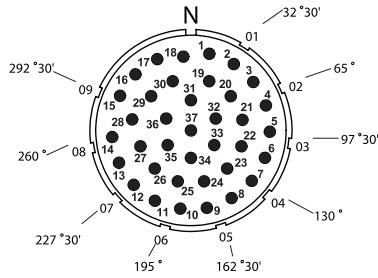

321

Key position <i>(add to end of part number)</i>		
01 30° 30'	04 130°	07 227° 30'
02 65°	05 162° 30'	08 260°
03 97° 30'	06 195°	09 292° 30'

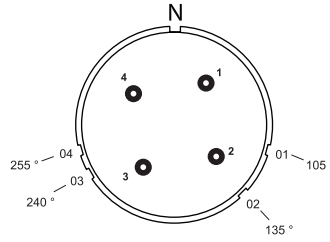

322

Key position <i>(add to end of part number)</i>	
01 105°	03 240°
02 135°	04 255°

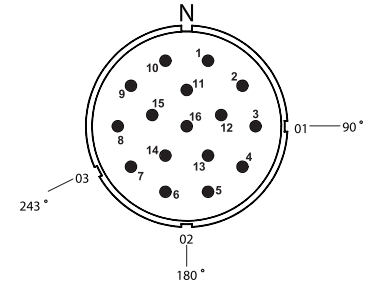

325

Key position <i>(add to end of part number)</i>	
01 90°	03 243°
02 180°	

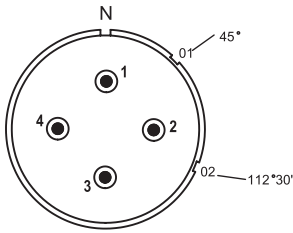

328

Key position <i>(add to end of part number)</i>	
01 45°	02 112° 30'

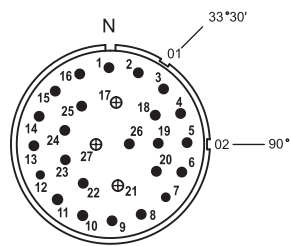

335

Key position <i>(add to end of part number)</i>	
01 33° 30'	02 90°

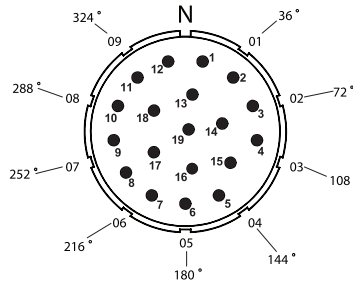

355

Key position <i>(add to end of part number)</i>		
01 36°	04 144°	07 252°
02 72°	05 180°	08 288°
03 108°	06 216°	09 324°

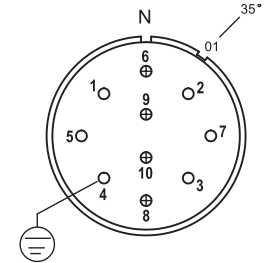

376

Key position <i>(add to end of part number)</i>	
01 35°	

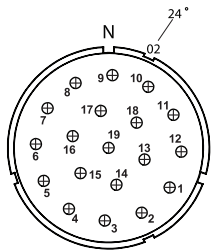

377

Key position <i>(add to end of part number)</i>	
02 24°	

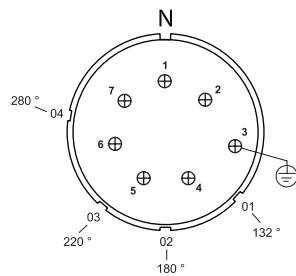

378

Key position <i>(add to end of part number)</i>	
01 132°	03 220°
02 180°	04 280°

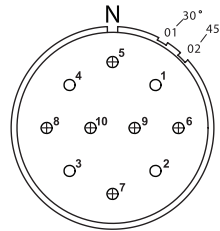

381

Key position <i>(add to end of part number)</i>	
01 30°	02 45°

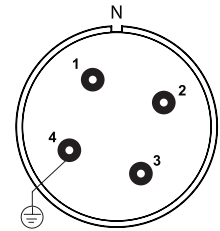

38

Key position <i>(add to end of part number)</i>	
No rotations	

Appendix

Inserts – 20 shell clocking options and ground contact location

Example: **CZ-PEKL-1620-331PN-01**

● Alternate key position

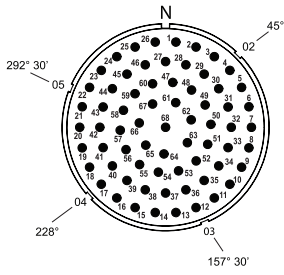

313

Key position

(add to end of part number)

02	45°	04	228°
03	157° 30'	05	292° 30'

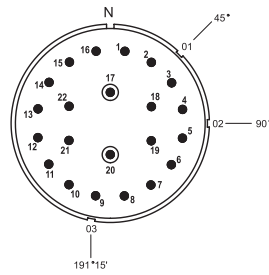

331

Key position

(add to end of part number)

01	45°	03	191° 15'
02	90°		

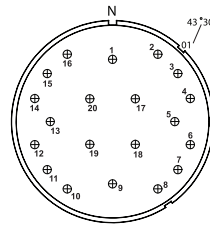

332

Key position

(add to end of part number)

01	43° 30'
----	---------

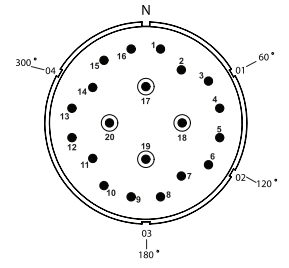

334

Key position

(add to end of part number)

01	60°	03	180°
02	120°	04	300°

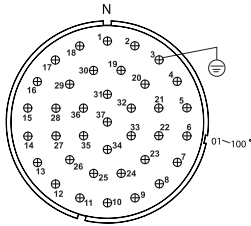

350

Key position

(add to end of part number)

01	100°
----	------

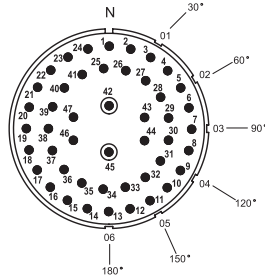

354

Key position

(add to end of part number)

01	30°	04	120°
02	60°	05	150°
03	90°	06	180°

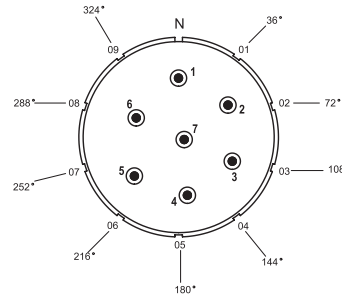

359

Key position

(add to end of part number)

01	36°	04	144°	07	252°
02	72°	05	180°	08	288°
03	108°	06	216°	09	324°

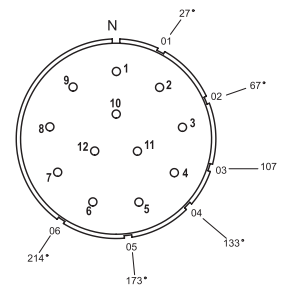

375

Key position

(add to end of part number)

01	27°	04	133°
02	67°	05	173°
03	107°	06	214°

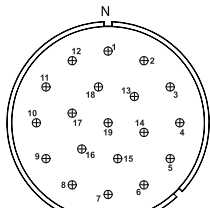

376

Key position

(add to end of part number)

No rotations

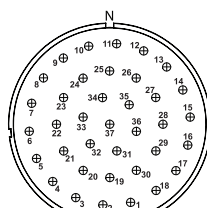

386

Key position

(add to end of part number)

No rotations

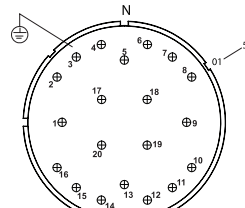

387

Key position

(add to end of part number)

01	56°
----	-----

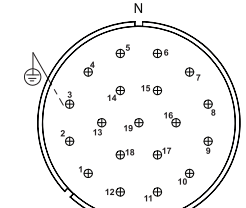

388

Key position

(add to end of part number)

No rotations

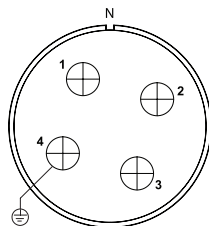

40

Key position

(add to end of part number)

No rotations

Inserts – 24 shell clocking options and ground contact location

Example: CZ-PEKL-1624-371PN-01

• Alternate key position

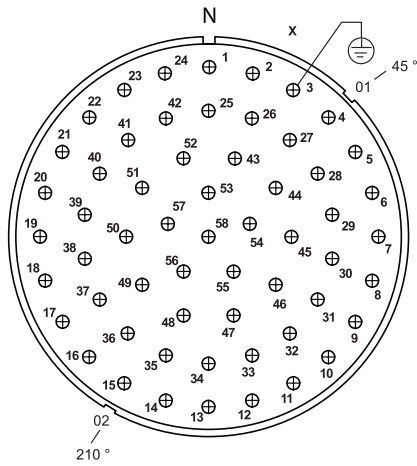

352

Key position <i>(add to end of part number)</i>	
01	45°
02	210°

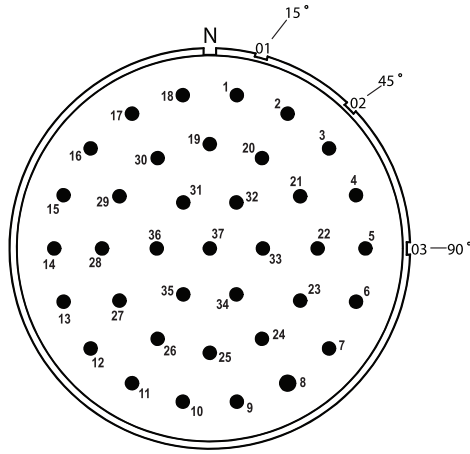

371

Key position <i>(add to end of part number)</i>	
01	15°
03	90°
02	45°

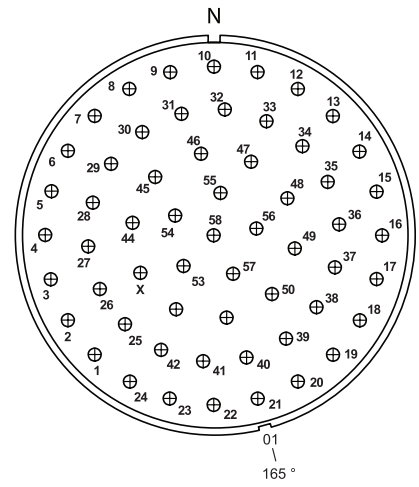

384

Key position <i>(add to end of part number)</i>	
01	165°

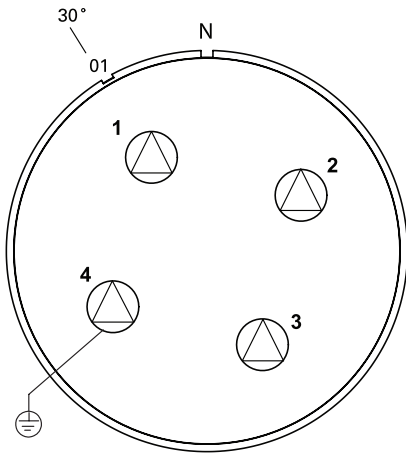

26

Key position <i>(add to end of part number)</i>	
01	30°

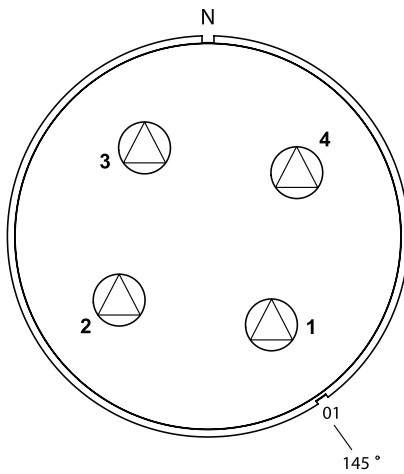

38

Key position <i>(add to end of part number)</i>	
01	145°

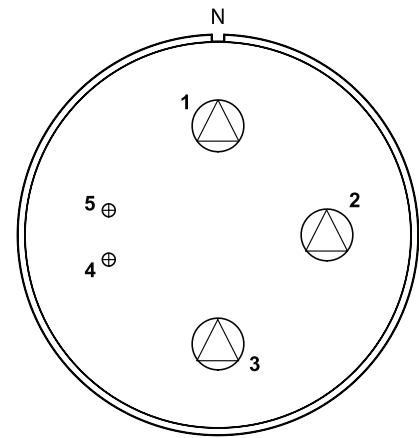

48

Key position <i>(add to end of part number)</i>	
No rotations	

Inserts – 28 shell clocking options and ground contact location

Example: CZ-PEKL-1628-339PN-01

• Alternate key position

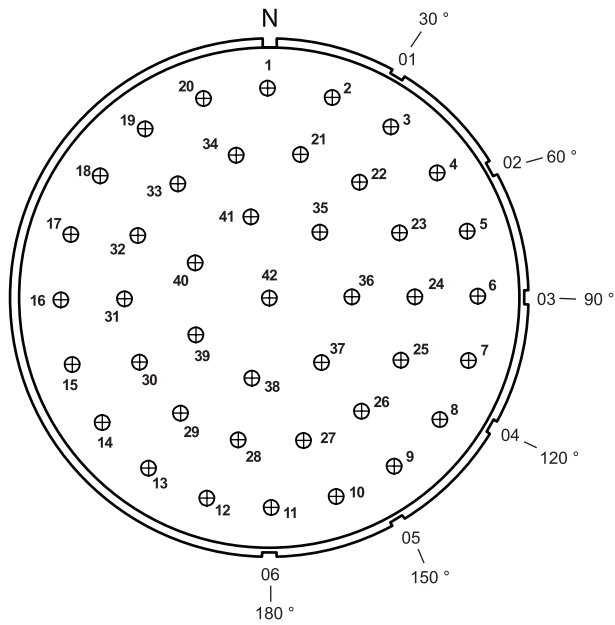

339

Key position	
<i>(add to end of part number)</i>	
01	30°
02	60°
03	90°
04	120°
05	150°
06	180°

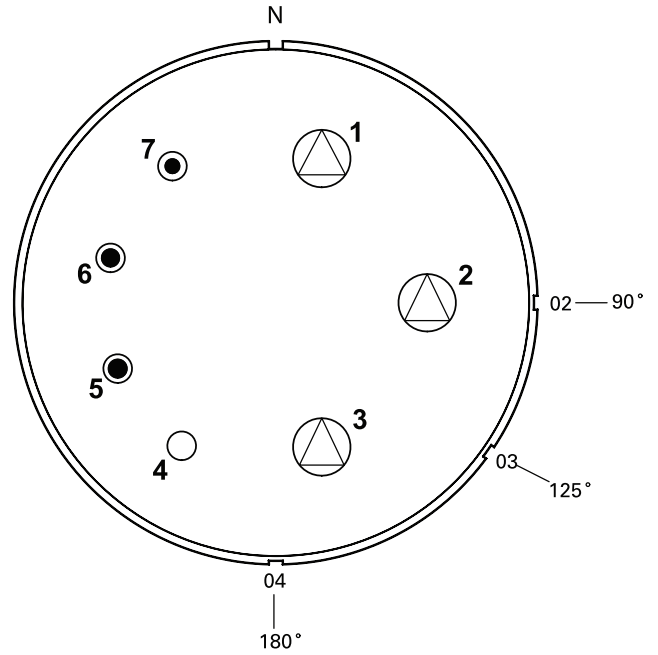

H44

Key position	
<i>(add to end of part number)</i>	
02	90°
03	125°
04	180°

Eaton
1000 Eaton Boulevard
Cleveland, OH 44122
United States
Eaton.com

Crouse-Hinds Division
1201 Wolf Street
Syracuse, NY 13208
Crouse-Hinds.com

© 2021 Eaton
All Rights Reserved
Printed in USA
Publication No. 5479-0321
March 2021

**U.S. (global headquarters):
Eaton's Crouse-Hinds business**

1201 Wolf Street
Syracuse, NY 13208

(866) 764-5454
FAX: (315) 477-5179
FAX Orders Only:
(866) 653-0640

crousecustomerctr@eaton.com

Eaton's B-Line business

509 West Monroe Street
Highland, IL 62249

800-851-7415
FAX: 618-654-1917

Eaton.com/b-lineseries

IEC Electrical
(CEAG products)

49 (0) 6271 806-500
FAX: 49 (0) 6271 806-476

Info-ex@eaton.com

Airport Lighting

866-764-5454

CrouseCustomerCTR@Eaton.com

Mexico/Latin America/Caribbean

52-555-804-4000
FAX: 52-555-804-4020

ventascentromex@eaton.com

Haz Area Communications
(MEDC, Hernis, Oxalis, FHF Sonix)

44 (0) 1623 444400
FAX: 44 (0) 1623 444531

MEDCAdmin@Eaton.com

Canada

Toll Free: 800-265-0502
FAX: (800) 263-9504
FAX Orders only: (866) 653-0645

China

86-21-2899-3600
FAX: 86-21-2899-4055

cchsales@cooperindustries.com

Process instrumentation
(MTL products)

44 (0) 1582 723633
FAX: 44 (0) 1582 422283

enquiry@mtl-inst.com

Eaton Middle East

9714-8066100
FAX: 9714-8894813

chmesales@eaton.com

Australia

61-2-8787-2777
FAX: 61-2-9609-2342

CEASales@cooperindustries.com

For more information:

If further assistance is required, please contact an authorized Eaton Distributor, Sales Office, or Customer Service Department.

Eaton
1000 Eaton Boulevard
Cleveland, OH 44122
United States
Eaton.com

© 2021 Eaton
All Rights Reserved
Printed in USA
Publication No. 5479-0321
March 2021



Eaton is a registered trademark.

All other trademarks are property of their respective owners.

Follow us on social media to get the latest product and support information.

